

ASM 142 S

HELIUM LEAK DETECTOR



User's Manual

adixen
by Alcatel Vacuum Technology





Alcatel Vacuum Technology, as part of the Alcatel Group, has been supplying vacuum pumps, leak detection systems, vacuum measurement and micro machining systems for several years.

Thanks to its complete range of products, the company has become an essential player in multiple applications : instrumentation, Research & Development, industry and semiconductors.

Alcatel Vacuum Technology has launched Adixen, its new brand name, in recognition of the company's international standing in vacuum position.

With both ISO 9001 and 14001 certifications, the French company is an acknowledged expert in service and support, and Adixen products have the highest quality and environmental standards.



With 40 years of experience, AVT today has a worldwide presence, through its international network that includes a whole host of experienced subsidiaries, distributors and agents.

The first step was the founding of Alcatel Vacuum Products (Hingham- MA) in the United States, thirty years ago, reinforced today by 2 others US subsidiaries in Fremont (CA) and Tempe (AZ).

In Europe, AVTF-France headquarters and three of its subsidiaries, Alcatel Hochvakuumtechnik (Germany), Alcatel Vacuum Technology UK (Scotland) and Alcatel Vacuum Systems (Italy) form the foundation for the European partner network.

In Asia, our presence started in 1993 with Alcatel Vacuum Technology (Japan), and has been strengthened with Alcatel Vacuum Technology Korea (in 1995), Alcatel Vacuum Technology Taiwan (in 2001), Alcatel Vacuum Technology Singapore, and more recently with Alcatel Vacuum Technology Shanghai (China) (in 2004).

This organization is rounded off by more than 40 representatives based in a variety of continents.

Thus, whatever the circumstances, the users of Adixen products can always rely on quick support of our specialists in Vacuum Technology.



CHINA

Alcatel Vacuum Technology, Shanghai
N°82 Lane 887 Zuchongzhi Road
Zhangjiang High-Tech Park,
Shanghai 201203 - P.R. China
Tel. (86) 21 5027 0628
Fax. (86) 21 3895 3815

FRANCE

Alcatel Vacuum Technology France
98, avenue de Brogny - BP 2069
74009 Annecy cedex
Tel. (33) 4 50 65 77 77
Fax. (33) 4 50 65 77 89

GERMANY

Alcatel Hochvakuumtechnik GmbH
Am Kreuzeck 10 - Postfach 1151
97877 Wertheim
Tel. (49) 9342 9610 00
Fax. (49) 9342 9610 30

ITALY

Alcatel Vacuum Systems
Via Trento, 30
20059 Vimercate (Mi)
Tel. (39) 0396 86 38 55
Fax. (39) 039 66 71 25

JAPAN

Alcatel Vacuum Technology Japan
4-3-10 Shimokodanaka,
Nakahara-ku
Kawasaki, Kanagawa 211-0041
Tel. (81) 44-797-5920
Fax. (81) 44-797-5932

KOREA

Alcatel Vacuum Technology Korea
4th Floor, Sunghyun B/D
10-5, Karak-Dong, Songpa-Ku -Seoul
Tel. (82) 2 409 6277
Fax. (82) 2 409 6279

SINGAPORE

Alcatel Singapore Pte Ltd
49 Jalan Pemimpin
#01-01 APS Industrial Building
577203 Singapore
Tel. (65) 62540828
Fax. (65) 62547018

TAIWAN

Alcatel Vacuum Taiwan
No. 169-3, Sec.1, Kang-Leh Rd
Song-Lin Village, Hsin-Feng 304
Hsin-Chu County, Taiwan -R.O.C.
Tel. (886) 35599230
Fax.(886) 35599231

UNITED KINGDOM

Alcatel Vacuum Technology UK Ltd
8 Bain Square Kirkton
Campus Livingston - West
Lothian EH54 7DQ
Scotland
Tel. (44) 1 506 418 000
Fax. (44) 1 506 418 002

USA

Alcatel Vacuum Products
67, Sharp Street
Hingham - MA 02043
Tel. (1) 781 331 4200
Fax. (1) 781 331 4230



A very wide range of helium leak detectors

Dear customer,

You have just bought an Alcatel leak detector. We would like to thank you and we are proud to count you among our customers. This product is a result of the experience acquired over 35 years by Alcatel in vacuum and leak detection technology.

The applications of helium leak testing are extremely diversified ranging from high-tech installation maintenance to high-speed testing of industrial products.

Each product of the ALCATEL detector range is designed to meet the specific needs of each application:

- portability,
- high sensitivity,
- pumping capacity,
- pumping type,
- automation and integration in an industrial process.



A very wide range of helium leak detectors

This product complies with the requirements of European Directives, listed in the Declaration of Conformity contained in G100 of this manual. These Directives are amended by Directive 93/68/E.E.C (E.C. Marking).

The Declaration of Conformity and Safety Instructions are available in German, Spanish, Italian, Portuguese, Dutch and Danish languages at the end of this manual.

Copyright/Intellectual property:

The use of Alcatel products are subject to copyright and intellectual property rights in force in any jurisdiction.

All rights reserved, including copying this document in whole or any part without prior written authorization from Alcatel Vacuum Technology France.

Specifications and information are subject to change without notice by from Alcatel Vacuum Technology France.

General contents

ASM 142 S - User's Manual

Preliminary remarks Throughout this User's Manual, you could find this type of message "Summary of screen  C 140": it refers to a specific chapter of the User's Manual. Please read it for further information.

Chapter A

INTRODUCTION

- A 100 - Introduction to the ASM 142 series
- A 200 - ASM 142 S detector operating principle
- A 300 - Analyzer cell operating principle
- A 400 - Testing methods
- A 500 - Operator interface
- A 600 - Options
- A 700 - Accessories
- A 800 - ASM 142 S Technical characteristics
- A 900 - Dimensions

Chapter B

INSTALLATION

- B 100 - Safety instructions
- B 110 - Unpacking - Storage - Transportation
- B 200 - Neutral gas purge and inlet vent connection
- B 210 - Connecting the detector to the installation
- B 300 - Controlling the detector with the I/O interface
- B 310 - Controlling the detector with a PC computer through the RS 232 interface
- B 320 - Connecting the detector directly to a printer or another device
- B 400 - Before starting up the leak detector

Chapter C

OPERATION

- C 100 - Factory configuration of the leak detector parameters
- C 110 - Operating principle of the control panel
- C 120 - Setting and maintenance part presentation of the control panel
- C 130 - Access to level  - Password
- C 140 - Summary of screens
- C 200 - Starting up / Switching off the leak detector
- C 211 - Operation of the leak detector
- C 213 - Display
- C 300 - Calibration of the leak detector
- C 301 - Calibration of the leak detector
- C 305 - Calibrated leak values programming
- C 306 - Adaptator for calibrated leak
- C 400 - Remote control
- C 410 - Headphone and loudspeaker
- C 430 - 3 masses option
- C 450 - Long distance sniffer probe and Helium spray gun
- C 520 - Audio alarm/Digital voice
- C 540 - Zero function
- C 570 - Date - Time - Language - Unit
- C 580 - Fault / information indicator and display
- C 590 - Massive function

Chapter D

MAINTENANCE - TROUBLESHOOTING

- D 100 - Table of preventive maintenance intervals
- D 200 - Maintenance message
- D 210 - Calibrated leak calibration supervision
- D 300 - General troubleshooting guide
- D 400 - Symptoms description

Chapter E

MAINTENANCE SHEETS

- E 100 - Maintenance operations instruction
- E 110 - Access to internal detector components ASM 142 / ASM 142 S
- E 400 - Basic maintenance of the analyzer cell
- E 530 - Valves installation and maintenance
- E 560 - Exchange of the internal calibrated leak (option)
- E 600 - Remote control exchange
- E 610 - Long distance sniffer probe and Helium spray gun
- E 730 - Starting of the molecular and turbomolecular pumps
- E 750 - Primary pump maintenance

Chapter F

COMPONENTS

- F 000 - Spare parts - Instructions of use
- F 001 - AVTF Customer Service Offer
- F 100 - Tools
- F 200 - Monitoring and display
- F 300 - Power and electrical supply
- F 400 - Automatic control system and electronic circuits
- F 500 - Measurement
- F 600 - Pumping
- F 700 - Valves
- F 800 - Pipes - connections - Seals
- F 900 - Cover
- F 1000 - Options and accessories
- F 1100 - Pictures of components

Chapter G

APPENDIX

- G 100 - Declaration of conformity
- G 200 - Wiring diagrams
- G 300 - 0 - 8 Volts Analog output
- G 400 - Long distance sniffer probe user manual
- G 500 - Helium spray gun user manual
- G 600 - Safety questionnaire



Introduction

ASM 142 S User's Manual Detailed contents

Preliminary remarks Throughout this User's Manual, you could find this type of message "Summary of screen  C 140": it refers to a specific chapter of the User's Manual. Please read it for further information.

A 100

Introduction to the ASM 142 serie

A 200

ASM 142 S detector operating principle

- Vacuum circuit
- Stand-by mode
- Sniffing test mode

A 300

Analyzer cell operating principle

- Description
- Design and manufacture

A 400

Testing methods

- Overview
- Helium concentration and signal displayed
- Spray method (inboard testing)
- Sniffer method (outboard testing)
- Bombing method

A 401

About Helium and hydrogen

- Helium
- Helium and leak detection: which purity ?
- Hydrogen
- Helium, Hydrogen and sensitivity
- And now some wrong ideas

A 500

Operator interface

- Control panel



Introduction

ASM 142 S User's Manual Detailed contents

A 600

Options

- Which options for which model?
- Metal seals
- Inlet port
- Units
- Languages
- 3 masses
- Automatic test chambers
- Roughing system
- Interface board
- Remote control cable length
- Test of gas line
- Stainless steel cover (UCT)
- Control panel with graphic interface
- Internal calibrated leak
- LDS probes

A 700

Accessories

- Which accessories for which model?
- Standard remote control with cable
- Sniffing remote control and cable
- Long Distance Sniffer probe
- 10 m/30 feet LDS extension
- Headphone connector
- Transport cart
- Foot pedal for cycle command (1.5 m/5 feet)
- Calibrated Helium leaks
- Calibration accessory
- Spray probe
- Inlet adaptor
- Printer
- Inlet filters
- Short distance sniffer probe (to be connected to the inlet part of a leak detector)
- Bombing chamber
- Tests chambers (required interface board)
- Neutral gas vent ling kit
- 4 swiveling wheels kit (Ø125 mm)
- Covered sniffer probe and remote control kit
- Bottle handle for cart

A 800

ASM 142 S Technical characteristics

A 900

Dimensions

Introduction to the ASM 142 series

A new generation of ALCATEL helium leak detector

The ASM 142/142 D/142 S/ASM GRAPH/ASM GRAPH D are universal helium leak detectors which set new performance standards for multi-purpose unit.

These detectors are the end-result of an innovative engineering approach utilizing the latest electronics technologies and vacuum concepts, which make them a truly universal unit:



Model photographed:
ASM 142

	ASM 142	ASM GRAPH	ASM 142 D	ASM GRAPH D	ASM 142 S
<input type="checkbox"/> high performances, such as, a roughing capacity of 7 CFM (60 l/mn) with a usable helium sensitivity in the 10 ⁻¹¹ atm.cc/sec range,	x	x			
<input type="checkbox"/> high performances, such as, a dry roughing capacity of 0.9 CFM (1.5 m ³ /h) with a usable helium sensitivity in the 10 ⁻¹¹ atm.cc/sec range,			x	x	
<input type="checkbox"/> a usable helium sensitivity in the 10 ⁻⁷ atm.cc/sec range (with auto-zero function),					x
<input type="checkbox"/> comprehensive control panel with two distinct areas (one for the operation of the unit, the other for entering the test parameters),	x	x	x	x	x
<input type="checkbox"/> evolved features to assist the operator in his daily operation (auto-calibration, auto-zero, helium signal direct readout, ...).	x	x	x	x	x
<input type="checkbox"/> very rugged design, based on field-proven components, which makes it ideal for any industrial environment,	x	x	x	x	x
<input type="checkbox"/> various accessories to reinforce the versatility of the product (remote control, sniffer probe).	x	x	x	x	x
<input type="checkbox"/> totally dry leak detector,			x	x	
<input type="checkbox"/> specific to sniffing test mode applications.					x
<input type="checkbox"/> graphic interface		x		x	



We suggest that you read this manual before you start to use your detector to obtain optimum levels of performance and complete satisfaction.

ASM 142 S detector operating principle

Vacuum circuit

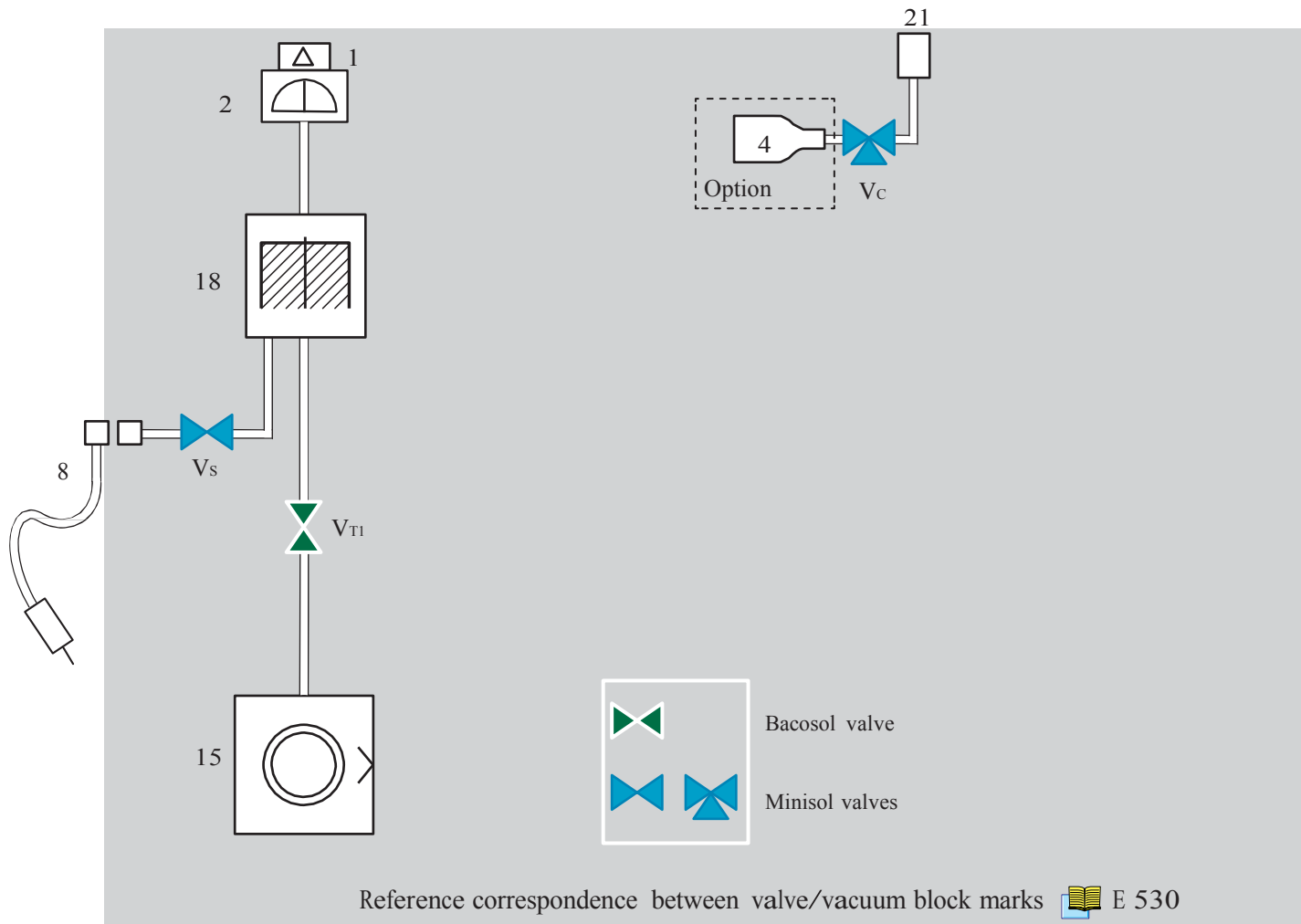

- | | | | |
|----|--|-----------------|-------------------|
| 1 | Preamplifier | V _C | Calibration valve |
| 2 | Analyzer cell | V _{T1} | Exhaust valve |
| 4 | Internal calibrated leak (option) | V _S | Sniffing valve |
| 8 | Long distance sniffer connector | | |
| 15 | Roughing primary pump (RVP 2005) | | |
| 18 | Detection molecular pump (AMP 007I) | | |
| 21 | Calibration port (if internal calibrated leak option) or automatic standby | | |

ASM 142 S detector operating principle

Standby mode

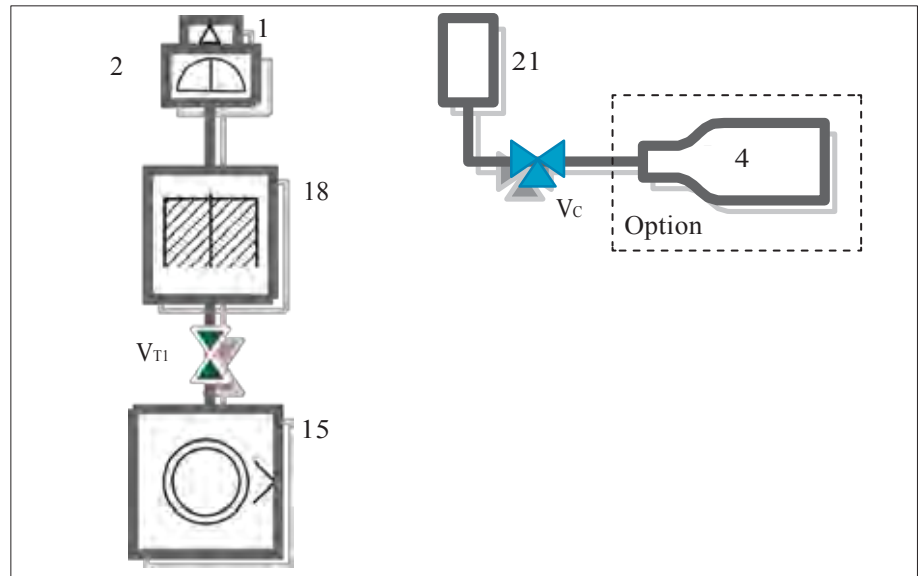

Sniffing test mode

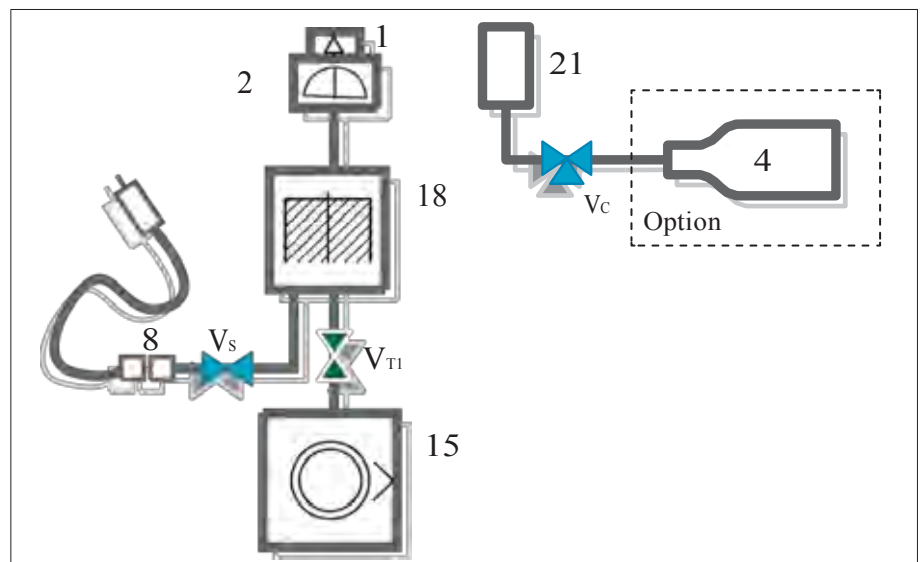

Analyzer cell operating principle

Description The analyzer cell works on the principle of mass spectrometry and is set to the mass of helium ($m/e = 4$).

$m/e = \text{atomic mass of the particle} / \text{number of electrons lost on ionization}$

The principle of magnetic deflexion spectrometry is as follows. The neutral molecules of the gas being analyzed pass into an ionization chamber (or source of ions) where they are bombarded by an electron beam generated by a heated tungsten filament. A large number of the molecules are transformed into ions.

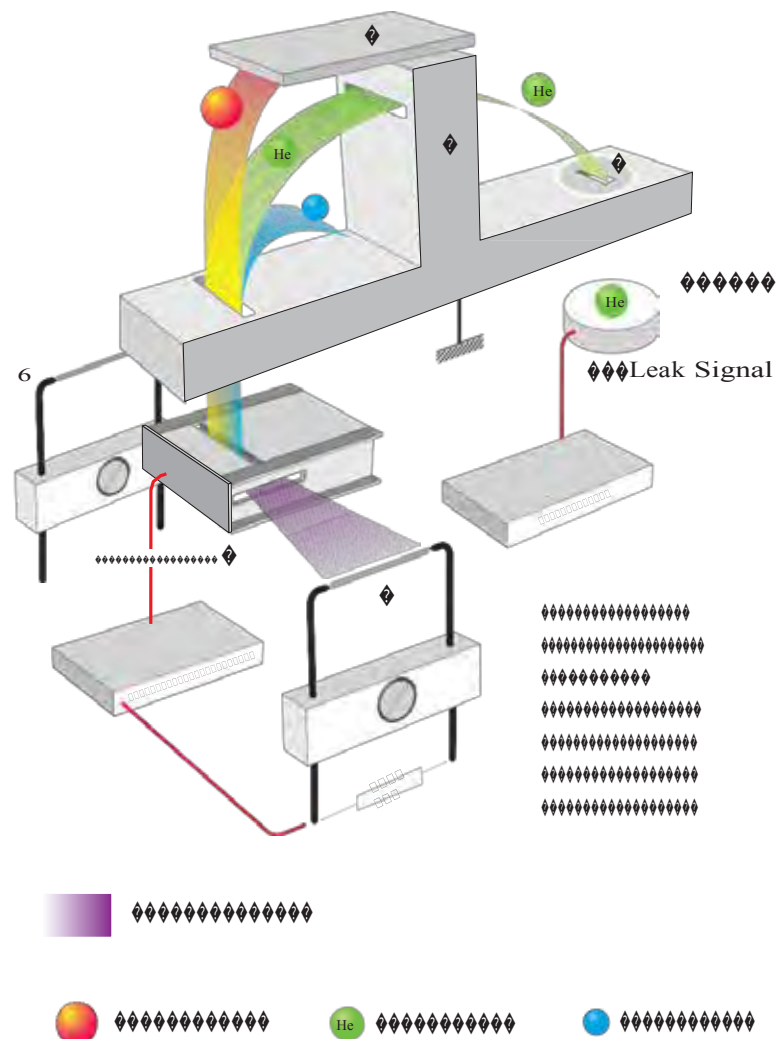

Analyzer cell - functional diagram

Analyzer cell operating principle

Description (continued) These ionized particles are accelerated by an electrical field.

The entire analyzer cell is subject to a magnetic field which has the property of deflecting the trajectories of the ions along different curves according to the masses of those ions (to be more precised, according to their m/e ratios). Thus the ions beam, which contained ions with different masses, is divided into several beams, each containing only ions with the same m/e ratio. The helium ions ($m/e = 4$) are separated from the lighter (H_2^+ or H^+ , smaller beams) or heavier ions (N_2^+ or O_2^+ , small beams).

Because there is a constant magnetic field (permanent magnet), the accelerator electrical field is adjusted so that the helium ions ($m/e = 4$) follow a pre-determined trajectory (passing through diaphragms) and arrive on the target at the input to a direct current amplifier.

The current of helium ions is proportional to the partial pressure of helium in the installation and by measuring it we can find the flow rate of the leak that has been detected.

It is essential that the total pressure in the analyzer cell is less than 10^{-4} mbar, so that the trajectories of the electrons and the ions are not disturbed by residual molecules.

Around 10^{-3} mbar there is a risk of damaging the heated filament.

In order to separate the helium ions from «noise» caused by «stray ions», an electrode located in front of the target eliminates the secondary ions with low energies. This electrode is called the «braking electrode».

There is an auxiliary electrode at the top of the cell, shaped like a plate, which collects the ions that are heavier than helium. This electrode thus measures the total pressure in the analyzer. This electrode serves as the plate for a triode gauge, hence its name of «triode electrode».

Analyzer cell operating principle

Design and manufacture

Great care has been taken with the design and manufacture of the cell in order to repeatedly obtain the same characteristics and to achieve excellent stability:

- the metal parts are made of stainless steel,
- the filament holder is made of machined aluminium,
- there is an integral amplifier.

The cell assembly is composed of:

- a vacuum chamber or deflection chamber,
- an optic holder flange,
- a permanent magnet,
- an amplifier.

- The vacuum chamber:

The analysis cell vacuum chamber is made of light alloy. It is hollow with a rectangular opening into which the electrodes, (that are installed on the «optics holder» flange) are placed.

- The optics holder flange:

The optics holder flange supports all the electrodes and electrical connections in the cell. They include:

- the sealed power supply socket, mounted on a metal gasket,
- the amplifier, mounted on an elastomer gasket,
- the supporting block which screens the target and on which the source of ions is mounted,
- the source of ions, which is made up of 2 parts:
 - a filament holder,
 - an ionization chamber with a stainless steel electron collector and a mass ion emitter.

The filament holder mechanically positions the tungsten filament with respect to the ionization chamber.

The electron collector and the filament have been designed and positioned so that the temperature of the electron collector stabilizes at 400°C under bombardment and radiation from the filament. The cell is thus rendered immune to contamination from the pieces being tested without the need of any special heating system.

Testing methods

Overview Leak detection is used to detect micro-openings, porosities, etc. in test parts. The detection of these cracks involves the use of a light tracer gas, which is capable of infiltrating the smallest leak quickly: Helium.

The detector samples and measures the helium flow rate entering the test part via the leak(s).

The testing method is selected according to the test part and the measurement accuracy required:

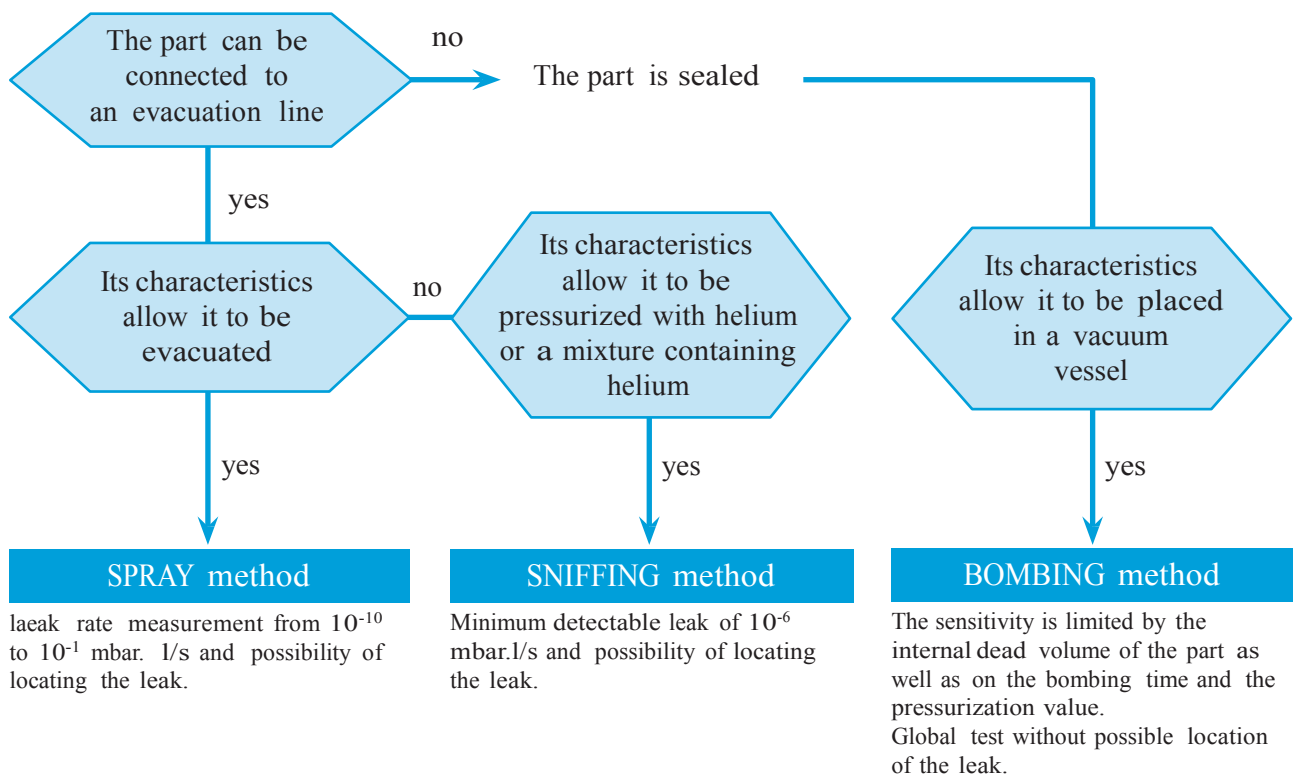

Testing methods

Helium concentration and signal displayed

In accordance to the He concentration rate in the gas used for the leak detection, the signal displayed will change.

Example: signal displayed with a 1×10^{-7} mbar.l/s calibrated leak (with 100 % He) connected to the detector inlet.

% He in the gas used	100 %	10 %	1 %
Signal displayed on the leak detector	1×10^{-7} mbar.l/s	1×10^{-8} mbar.l/s	1×10^{-9} mbar.l/s

Spray method (inboard testing)

This involves removing air from the test part, connecting it to the analyzer and then spraying helium over the outer surface.

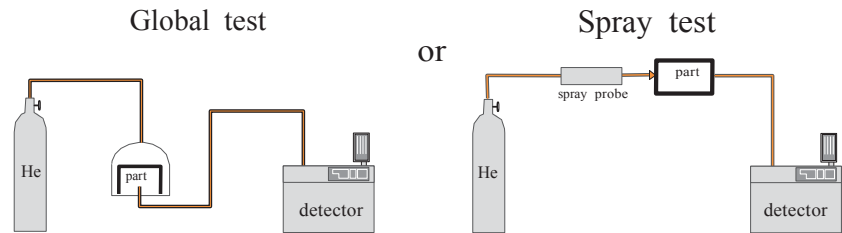

The part is placed under a cover, into which helium is injected.

Potential leaking areas are sprayed with helium.

The leak cannot be located.

The leak can be located.

The detector measures the flow of helium penetrating the part.

Response time

When spraying starts, the leak signal is not displayed instantaneously on the analyzer:

there is a response time which depends on the volume V being tested and the helium pumping speed S of the system at the opening of the part, according to the following relation:

$$T = V/S \quad (T \text{ in seconds, } V \text{ in litres, } S \text{ in l/s})$$

T is the time required for the signal to reach 63 % of the final value.

Testing methods

Sniffer method (outboard testing)

The test part is pressurized with helium. The detector, via an LDS (Long Distance Sniffer) probe, samples the helium escaping from the part.

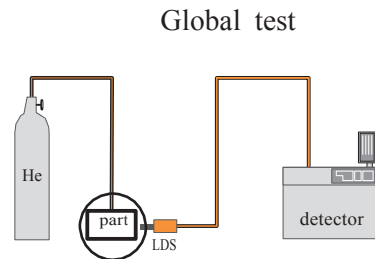

The part is placed under a cover containing a sniffer probe.

The leak cannot be located.

The helium from the leak accumulates over time inside the cover. The detector measures the concentration of helium.

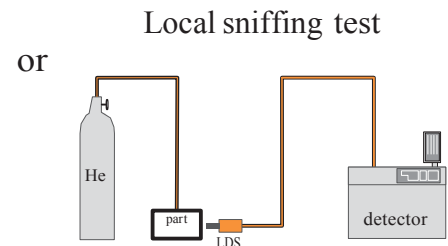

The sniffer probe is moved over areas likely to contain leaks.

The leak can be located.

The signal supplied by the analyzer is not a direct measurement of the leak. The sniffer probe only samples part of the helium escaping from the part. The sample depends on the distance separating the leak from the tip of the probe.

Testing methods

Bombing method This method is used for sealed objects that cannot be connected directly to the detector (semiconductors, waterproof watches, etc.).

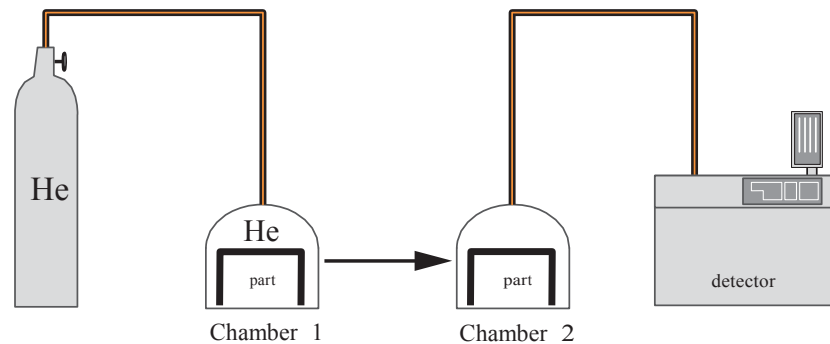

The part is placed in a chamber containing pressurized helium.

The helium penetrates the part if it has a leak.

The part is then removed from the chamber and placed in another vacuum chamber which is connected to the detector. The helium escapes from the part through the leak and produces a signal.

This signal is not a direct measurement of the leak as the helium pressure inside the part is difficult to determine. Several parts play an important part such as: the pressurization time, the helium bombing pressure, the internal volume, the aeration time, the size of the leak.

About Helium and hydrogen

Helium Helium is the second most common element in the universe, representing about 23 % of the total matter. 76 % is Hydrogen. All other elements represent an insignificantly small fraction of the total.

Helium was discovered by spectroscopy in a solar eclipse on August 18, 1868. The discovery in the sun's chromosphere gave the new element its name: "helios" in Greek means "sun". While Helium is very common in the universe most of it is in the stars: on earth it is actually not abundant. Since it is so light all the Helium present during the formation of earth escaped to space. Helium is created deep in the earth from the radioactive decay of Uranium and Thorium which also gives the earth its internal heat. On earth Helium was discovered in 1881 by spectroscopy of Mount Vesuvio in Italy – the volcanic gases emanated by the mountain showed the same lines in the spectrum as already known from the sun.

Helium concentration in the atmosphere is 5 times bigger than the one of Krypton and 60 times higher than Xenon. The heavier noble gases are isolated from air rectification. In contrary, Helium is "mined" from natural gas and oil wells. This is economical at concentrations above 0.4%. Helium comes up with the natural gas and is separated and stored. The annual world wide production is ca. 3×10^7 m³ or 4,500 tons.

It occurs in economically extractable amounts in certain natural gases. Natural resources can be found in the USA (Texas and Kansas) and Poland. Natural Helium concentrations reach up to 7 % in natural gas.

Helium is constantly seeping up from the ground all around us, but it is so light that almost all of it escapes into space fairly rapidly. On the other hand there is a constant flow of Helium from space and the sun to earth. This gives a dynamic equilibrium and is the reason for the world wide constant concentration of ca. 5 ppm Helium in air.

Helium is a very light colorless element and it is one of the six noble gases; the most difficult gas to liquefy.

Helium is a noble gas, which means it doesn't react with anything for all practical intents and purposes. It's used as an inert shield gas to protect things from oxidation – and of course as leak detection tracer gas.

Helium is a 100 % green gas and has absolutely no environmental impact on the atmosphere.

About Helium and hydrogen

Helium and leak
detection:
which purity ?

Helium is commercialized in many different purity levels, the highest level of purity is requested from some laboratories for fundamental researches or very accurate analyses.

The use of the Helium as a tracer gas into a mass spectrometer doesn't require such attention. A purity in the range of 97 % to 99 % is enough .

There is absolutely no risk of accuracy lost or contamination for the cell analyzer by using standard purity level of Helium gas.

Helium (Air Liquide and Linde sources, Europe)

Purity	Average market price (2004) in €/m ³
99,9995 %	27
99,999 %	13
99,5 %	10
97,5 %	8

The gas producers as Air Liquide, Linde, Praxair, Sanfu and others push customers to use high purity level for Helium, of course, because cost and margin are higher and your mission by selling Helium leak detector solution is to inform your customers about the mass spectrometer requirement in term of helium purity.

About Helium and hydrogen

Hydrogen Hydrogen (H₂) is the lightest element, has a gaseous specific gravity of 0.0695 and a boiling point of -423 F (-252.8 C) at atmospheric pressure. It is a colorless, odorless, tasteless, flammable gas found at concentrations of about 0.0001 % in air. Hydrogen is produced by several methods, including steam/methane reforming, dissociation of ammonia, and recovery from by-product streams from chemical manufacturing and petroleum reforming. Hydrogen can be stored and transported as either a gas a cryogenic liquid. Hydrogen is flammable in the concentration range 4 % to 75 % in air or oxygen and can detonate in the range 18 % to 60 % in air or oxygen .

Compared to the helium at same purity, hydrogen is less expensive than helium, but on the field the reality is different because to use Hydrogen under safe conditions you have to mix the Hydrogen with an inert gas like Nitrogen; the concentration of Hydrogen in Nitrogen must be lower the 5 % to be non-flammable in air or Oxygen.

And under this condition the price of the mixture is becoming more expensive.

Hydrogen (Air Liquide and Linde sources, Europe)

Purity	Average market price (2004) in €/m ³
99,999 %	13
99,995 %	12
99,5 %	9
Mixture 95 % N ₂ + 5 % H ₂	25 to 30

About Helium and hydrogen

Helium, Hydrogen and sensitivity

Because the Hydrogen must be used mixed at 5 % concentration with an inert gas to be safe, the sensitivity of the test drops by a factor of 20 compared to 100 % Hydrogen concentration.

Theoretical example

Reject point of the part to be tested: 5×10^{-5} mbar.l/s.

H₂ concentration: 100 %

Leak to be found: 5×10^{-5} mbar.l/s.

H₂ concentration: 10 %

Leak to be found: 5×10^{-6} mbar.l/s.

H₂ concentration: 5 %

Leak to be found: $2,5 \times 10^{-6}$ mbar.l/s.

Air conditioning example

The working pressure of the system to be tested is 50 bar and the allowed loss is 2,5 g per year.

If the system is filled with R410 refrigerant gas, the maximum allowed leak in R410 at 50 bars is $2,63 \times 10^{-5}$ mbar.l/s.

Calculation for equivalent leak with substitute gas

Pressure test: 8 bar, gas concentration 100 %

Equivalent leak in Hydrogen (H₂): $3,32 \times 10^{-5}$ mbar.l/s.

Equivalent leak in Helium (He): $1,66 \times 10^{-5}$ mbar.l/s.

Because Hydrogen is not a safe gas, the maximum concentration of H₂ in N₂ is 5 % to be non-flammable.

With a such concentration, the leak to be found becomes 20 times lower at $1,66 \times 10^{-6}$ mbar.l/s.

Conclusion

To control an air conditioning system and validate with a substitute gas that the system is tight you need for the Hydrogen method a leak detector 10 times more sensitive than a Helium leak detector.

To compare sensitivity between Helium and Hydrogen, you have to compared the following information:

Leak to be found	Gas used	Leak to be displayed
$5 \cdot 10^{-5}$ mbar.l/s	Helium	$5 \cdot 10^{-5}$ mbar.l/s
	Hydrogen mixture 95 % N ₂ + 5 % H ₂	$5 \cdot 10^{-6}$ mbar.l/s

About Helium and hydrogen

And now some wrong ideas

Helium is rare Yes, it is, but helium is an inexhaustible resource from the heart of the earth.

Helium is recovered most cost-effectively from natural gas and long-term contracts guarantee access to sources in the USA, Europe and North Africa.

Helium is expensive No, because the mass spectrometer doesn't require high level purity helium to detect accurately the leaks (97,5 % is enough).

Helium (Air Liquide and Linde sources, Europe)

Purity	Average market price (2004) in €/m ³
99,995 %	27
97,5 % => helium gas tracer	8

Hydrogen is less expensive than Helium No, because to have a safe hydrogen tracer gas, you have to use mixture (95 % N₂ + 5 % H₂).

Let see the following prices:

		Average market price (2004) in €/m ³
Helium	Purity: 97,5 %	8
Hydrogen	Mixture 95 % N ₂ + 5 % H ₂	25 to 30

Security: Hydrogen isn't dangerous ?

No, theoretically hydrogen isn't dangerous, if ...and if...

But reality is different and if all the mixtures of H₂ + inert gas in a bottle have a limited life time, probably, the bottle isn't so safe. The reason is: because of the weight of H₂ (the lightest element), over the time a stratification phenomenon occurs which leads to gas emanation of uncontrolled Hydrogen concentration at the top of the gas bottle and can detonate or be flammable in contact of air or oxygen.

If gas producers recommendation is "always roll on the floor a mixture H₂ bottle before use", it is to avoid the stratification phenomena and to recover homogeneous mixture.

Operator interface: control panel

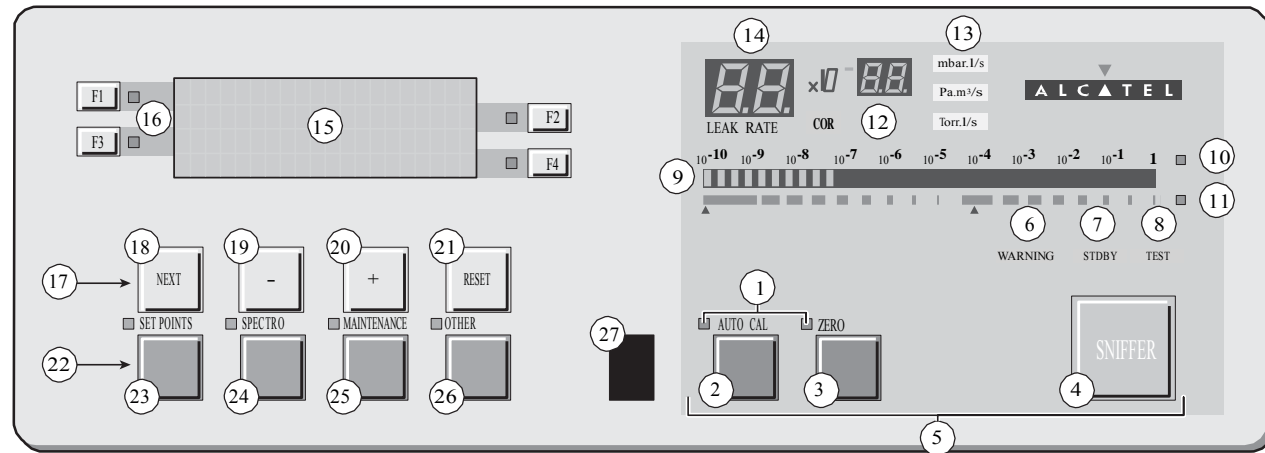

- 1 Control and menu selection indicators (ON when activated)
- 2 Autocalibration start/stop key
- 3 Zero start/stop key
- 4 Sniffing start/stop key
- 5 Control keyboard (3 keys)
- 6 Fault indicator
- 7 «Sniffing stop» state indicator
- 8 «Sniffing start» state indicator
- 9 Tracer gas analogic display
- 10 decades scale use indicator
- 11 2 decades scale use indicator
- 12 Extra units use indicator
- 13 Basic units use indicator
- 14 Digital display
- 15 Alphanumeric display (4 lines x 20 characters)
- 16 Parameter function keys (1 key per display line)
- 17 Modification access keys (4 keys)
- 18 NEXT : next display/parameter circular function
- 19/20 Plus or minus value adjustment, parameter selection, audio volume adjustment keys
- 21 RESET of previously displayed values (cancels temporary inputs)
- 22 Menu selection access keys (4 keys)
- 23 SET POINT menu selection key
- 24 SPECTRO calibration and analyzer cell configuration menu selection key
- 25 MAINTENANCE menu selection key
- 26 OTHER menus selection key (test mode selection, inlet VENT selection, date/time)
- 27 Remote control connection

Operation part

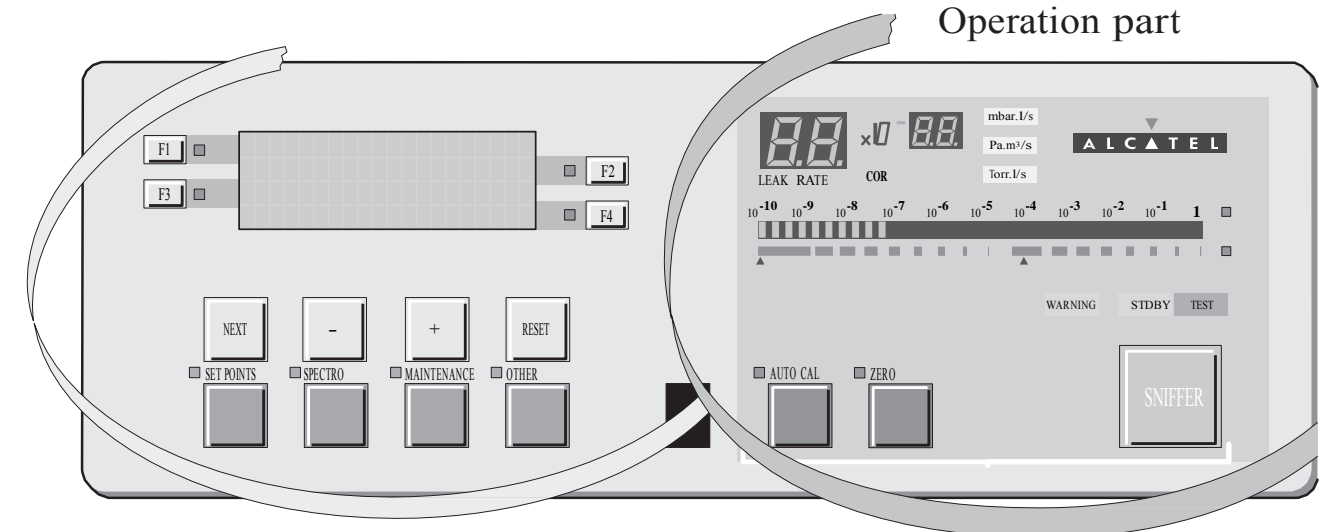

Setting and maintenance part (*)

* Operator access to setting and maintenance part depends on the user interface level.

User interface level C 120

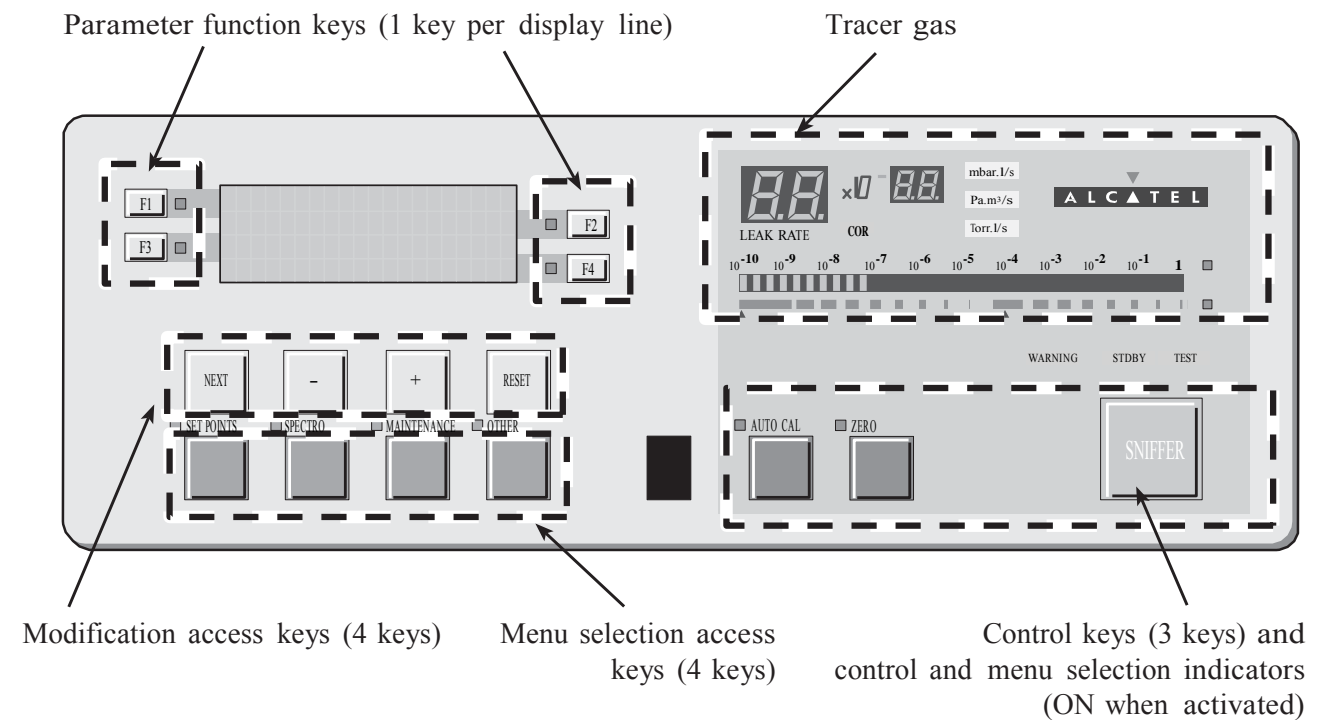

Remote control interface C 400

Operator interface: control panel

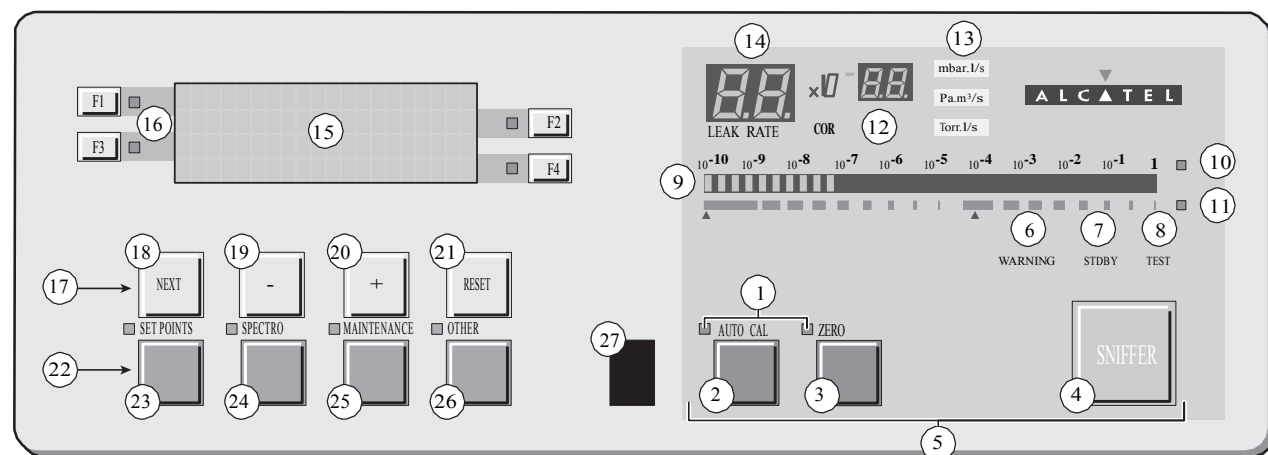

- 1 Control and menu selection indicators (ON when activated)
- 2 Autocalibration start/stop key
- 3 Zero start/stop key
- 4 Sniffing start/stop key
- 5 Control keyboard (3 keys)
- 6 Fault indicator
- 7 «Sniffing stop» state indicator
- 8 «Sniffing start» state indicator
- 9 Tracer gas analogic display
- 10 decades scale use indicator
- 11 2 decades scale use indicator
- 12 Extra units use indicator
- 13 Basic units use indicator
- 14 Digital display
- 15 Alphanumeric display (4 lines x 20 characters)
- 16 Parameter function keys (1 key per display line)
- 17 Modification access keys (4 keys)
- 18 NEXT : next display/parameter circular function
- 19/20 Plus or minus value adjustment, parameter selection, audio volume adjustment keys
- 21 RESET of previously displayed values (cancels temporary inputs)
- 22 Menu selection access keys (4 keys)
- 23 SET POINT menu selection key
- 24 SPECTRO calibration and analyzer cell configuration menu selection key
- 25 MAINTENANCE menu selection key
- 26 OTHER menus selection key (test mode selection, inlet VENT selection, date/time)
- 27 Remote control connection

Operation part

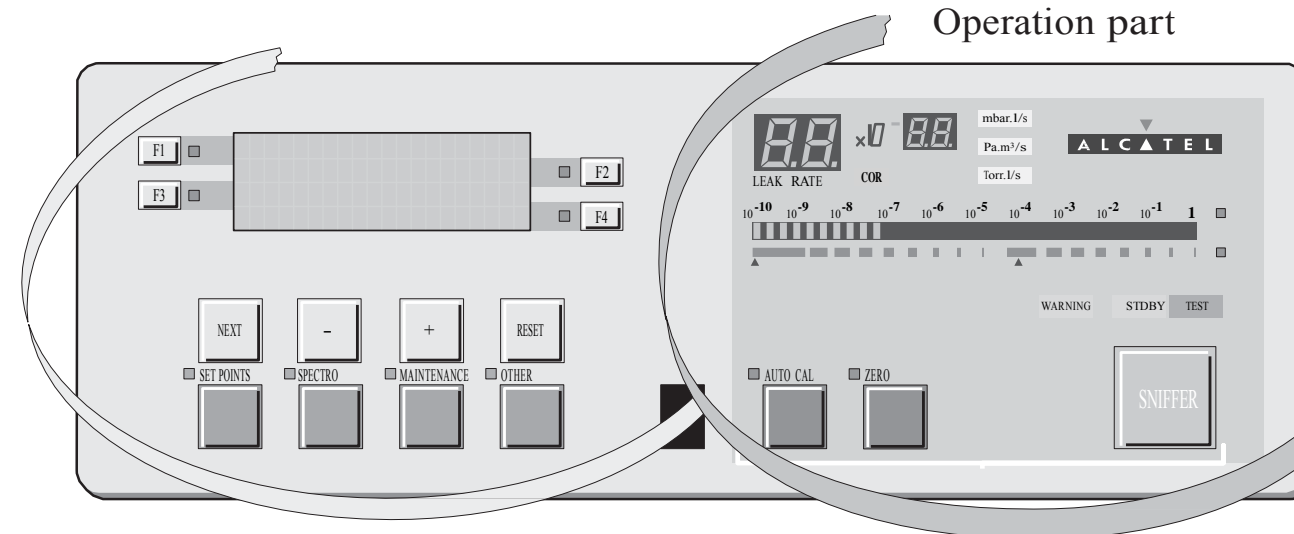

Setting and maintenance part (*)

* Operator access to setting and maintenance part depends on the user interface level.

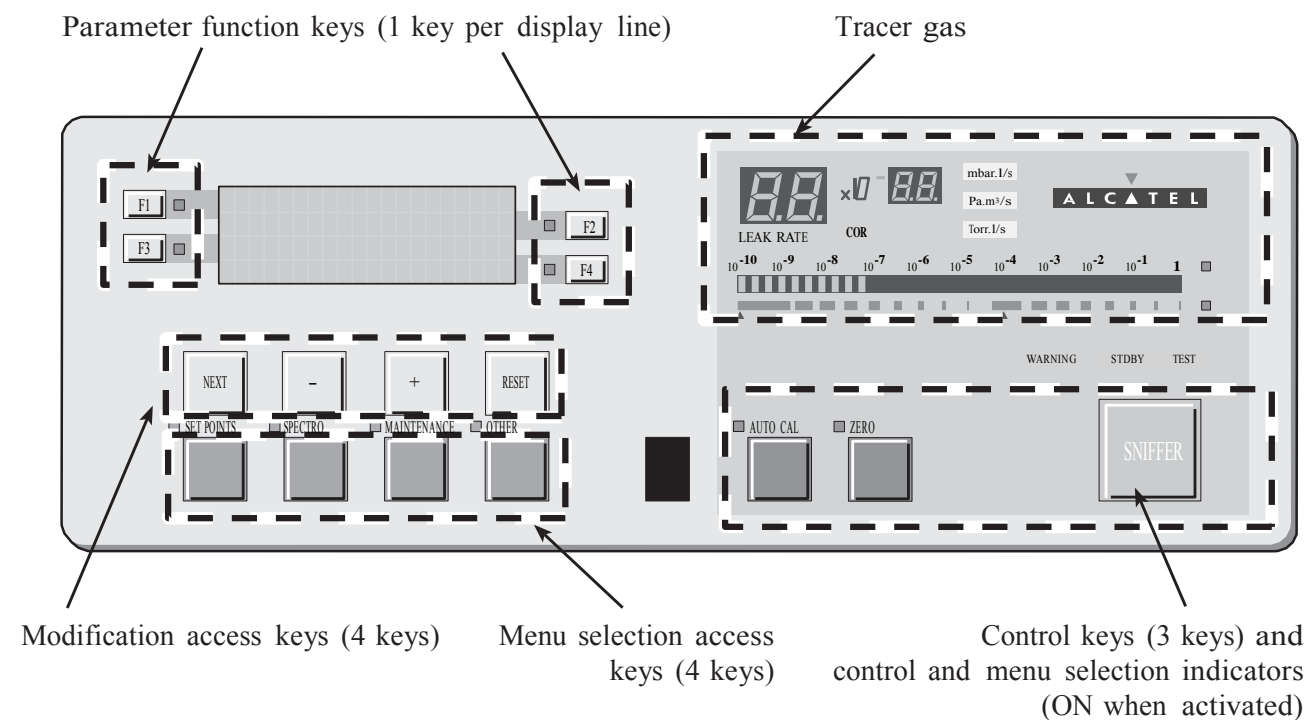

User interface level C 120



Remote control interface C 400

Options

Which options for
which model?

		ASM 102 S	ASM 122 D	ASM 142	ASM 142 S	ASM 142 D	ASM 182 T	ASM 192 T	ASM 192 T2	ASM 182 TD+	ASM 192 TD+	ASM 192 T2D+	ASM 1002
Metal seals	1		•	•		•	•	•	•	•	•	•	•
Inlet port	2		•										•
Units	3	•	•	•		•	•	•	•	•	•	•	•
Languages	4	•	•	•	•	•	•	•	•	•	•	•	•
3 masses	5	•	•	•	•	•	•	•	•	•	•	•	•
Automatic test chambers	6			•			•	•	•	•	•	•	•
Roughing system	7							•	•		•	•	
Interface board*	8			•	•	•							
Remote control cable length	9	•											
Test of gas line	10									•			
Stainless steel cover (UCT)	11									•			
Control panel with graphic interface*	12			•		•	•			•			
Internal calibrated leak	13				•								
LDS sniffer probes	14				•								
Transport cart*	 A 700									•			
Voltage configuration	-	•	•	•	•	•	•	•	•	•	•	•	•
Power plug	-	•	•	•	•	•	•	•	•	•	•	•	•
Standard remote control*	 A 700		•					•	•		•	•	•

*also available in accessories

Options

- Metal seals** Inlet and high vacuum manifolds and the analyzer cell are equipped with metal seals instead of elastomer seals to protect the leak detector against contamination with helium. This option is particularly useful in case of high sensitivity helium leak detection in an "helium contaminated environment".
- 1
- Localisation of the metal seals  F 800
- Inlet port** ASM 122 D: The standard DN 25 inlet port can be replaced by a DN 40 inlet port for convenience.
- 2
- ASM 1002: The test chamber can be replaced by a DN 25 inlet port for convenience.
- Units** The user can choice the unit of the software: mbar.l/s, Pa.m³/s or Torr.l/s.
- 3
- Languages** The user can choice the language of the software: English, French, German or Japanese.
- 4
- Note: ASM 142 S: English/French/German/Spanish.
ASM 1002: English/French.
- 3 masses** For use of one of the 3 following tracer gases:
Helium 4, Helium 3 or Hydrogen 2.
- 5
- Automatic test chambers** This is used for the automatic bombing testing of small components. When the chamber cover is closed, the test cycle is initiated, via a contact.
- 6
- 3 aluminium alloy models are available:
- a hemispheric chamber, Ø 72 mm, depth 31 mm (small model),
 - a cylindrical chamber, maximum Ø 85 mm and maximum depth 68 mm (medium model),
 - a cylindrical chamber, maximum Ø 160 mm and maximum depth 200 mm (large model).
- Note: ASM 142: large model not available.

Options

Roughing system

7

In order to reduce the roughing time when testing large volumes, a second roughing pump can be added to the roughing system:

- ASM 192 T / 192 T2 total capacity: 40 m³/h or 24 cfm.
- ASM 192 TD+ / 192 T2D+ total capacity: 50 m³/h or 36 cfm.

Apart from the roughing capacity, the weight and the power consumption, the characteristics and the use of the leak detector remain the same.

Interface board

8

The helium leak detector can be equipped with a software version which will offer a complete RS 232 protocol:

- 3 operating modes: basic, advanced, printer;
- possibility to remote control the detector (start/stop, autozero, auto-cal etc...);
- possibility to obtain and adjust the settings;
- possibility to obtain all the maintenance information for preventive maintenance purposes.

This RS 232 is the most effective interface to supervise your leak test from a PC (data recording on an Excel sheet, for instance) and/or to monitor the detector from a small PLC.

Remote control cable length

9

3 lengths are proposed: 5 m, 10 m and 15 m.

Test of gas line

10

Used to perform spray testing on long lines (typical diameter 1/4"), with a reduced response time due to the transfer of the helium by a carrier gas injected in viscous flow.

In this case, the detector is equipped with an additional 1/4" VCR connector specific to this option.

Stainless steel cover (UCT)

11

Designed for use of the unit in clean rooms ("Ultra Clean Technology").

The front and rear covers and frame are made of stainless steel.

Options

Control panel with graphic interface

12

The control panel with graphic interface is equipped with a color touch screen. It allows it to have, as a supplement to the standard control panel functions, a graphic interface.

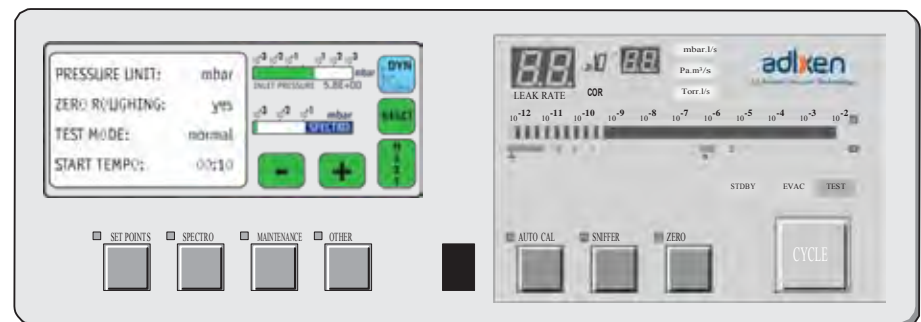

Internal calibrated leak

13

A calibrated leak is placed inside the leak detector for its calibration.
Leak value : $2 \cdot 10^{-5}$ mbar.l/s

Note: The calibrated leak is placed in standard in all the leak detectors except the ASM 102 S and the ASM 142 S (in option only for the ASM 142 S).

LDS probes



14

The leak detector is delivered with a long distance sniffer probe.

- 8 models are available:
- with a 5 m tube length and:
 - 9 cm rigid nozzle
 - 30 cm rigid nozzle
 - 15 cm flexible nozzle
 - 45 cm flexible nozzle
 - with a 10 m tube length and:
 - 9 cm rigid nozzle
 - 30 cm rigid nozzle
 - 15 cm flexible nozzle
 - 45 cm flexible nozzle.

Accessories

Which accessories for
which model?

		ASM 102 S	ASM 122 D	ASM 142	ASM 142 S	ASM 142 D	ASM 182 T	ASM 192 T	ASM 192 T2	ASM 182 TD+	ASM 192 TD+	ASM 192 T2D+	ASM 1002
Standard remote control and cable*	1		•	•		•	•	•	•	•	•	•	•
Sniffing remote control and cable	1	•			•								
Long distance sniffer (LDS) probe	2	•	•	•	•	•	•	•	•	•	•	•	•
10 m/30 feet LDS extension	3	•	•	•	•	•	•	•	•	•	•	•	•
Headphone connector (required interface board)	4			•	•	•	•	•	•	•	•	•	•
Transport cart*	5			•	•	•	•			•			
Foot pedal for cycle command (1.5 m/ 5 feet)	6						•	•	•	•	•	•	•
Calibrated helium leaks	7	•	•	•		•	•	•	•	•	•	•	•
Calibration accessory	8	•											
Spray probe	9	•	•	•	•	•	•	•	•	•	•	•	•
Interface board* (p/n 107657)	 A 600			•	•	•							
Inlet adaptor	10												•
Printer	11												
Inlet filter	12		•	•		•	•	•	•	•	•	•	•
Short distance sniffer probe	13		•	•		•	•	•		•	•		•
Bombing chamber	14		•	•		•	•	•	•	•	•	•	•
Test chambers	15		•	•		•	•	•	•	•	•	•	•
Neutral gas vent line kit	16			•									
4 swiveling wheels kit	17							•	•		•	•	
Covered sniffer probe and remote control kit	18				•								
Bottle handle for cart	19									•			
Control panel with graphic interface* (p/n 111716)	 A 600			•		•	•			•			

*also available in options

Accessories

Remote control

1



The remote control is equipped with a magnet allowing the operator to place it on a magnetized surface. The operator can read the helium signal and has access to control keys such as cycle command auto-calibration and auto-zero.

2 models are available:

- 1 standard for all leak detectors except ASM 102 S / ASM 142 S: Remote control with 5 m/15 feet cable length:

Model	Part No
Unit: mbar.l/s - Front face in English	106 688
Unit: Torr.l/s - Front face in English	108 881
Unit: Pa.m ³ /s - Front face in English	108 880
Unit: Pa.m ³ /s - Front face in Japanese	106 690

Note: The remote control is delivered in standard with the ASM 192 series and ASM 122 D.

English serigraphy



mbar.l/s
or Torr.l/s
or Pa.m³/s



Japanese serigraphy



Pa.m³/s
only



- 1 specific for sniffing leak detectors (ASM 102 S / ASM 142 S):

Remote control with 5 m/15 feet cable length:

Model	Part No
Unit: mbar.l/s - Front face in English	112 747



Cable for remote control (remote control not provided):

Designation	Part No
Cable of 10 m/394"	101 881
Cable of 15 m/591"	101 882
Cable of 20 m/797"	802 494
Cable of 25 m/984"	802 339
Cable of 30 m/1181"	802 767
Cable of 35 m/1378"	802 768
Cable of 40 m/1575"	802 769
Cable of 45 m/1772"	802 770
Cable of 50 m/1969"	802 771



Cable only

Accessories

Long Distance Sniffer probe

2

Sniffer probe with a rigid nipple



Sniffer probe with a flexible nipple



LDS probe part number	5 m canalisation				10 m canalisation			
	Rigid nipple		Flexible nipple		Rigid nipple		Flexible nipple	
	9 cm	30 cm	15 cm	45 cm	9 cm	30 cm	15 cm	45 cm
	SNC1E1T1	SNC1E2T1	SNC1E3T1	SNC1E4T1	SNC2E1T1	SNC2E2T1	SNC2E3T1	SNC2E4T1

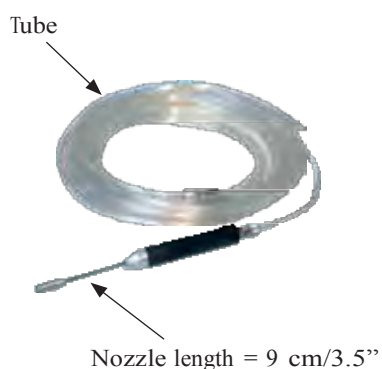

Long distance sniffer with short rigid nozzle:

Designation	Part No
Tube length 20 m/787"	802 826
Tube length 30 m/1181"	802 827
Tube length 40 m/1575"	802 828
Tube length 50 m/1969"	802 829
Tube length 60 m/2362"	802 830
Tube length 70 m/2756"	802 831
Tube length 80 m/3150"	802 832
Tube length 90 m/3543"	802 833
Tube length 100 m/3937"	802 834

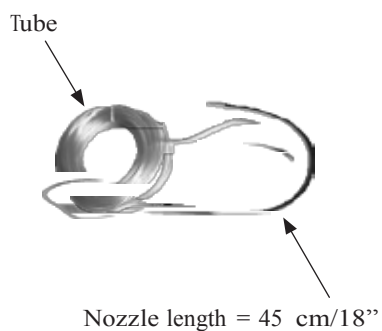

Long distance sniffer with long flexible nozzle:

Designation	Part No
Tube length 20 m/787"	802 835
Tube length 30 m/1181"	802 836
Tube length 40 m/1575"	802 837
Tube length 50 m/1969"	802 838
Tube length 60 m/2362"	802 839
Tube length 70 m/2756"	802 840
Tube length 80 m/3150"	802 841
Tube length 90 m/3543"	802 842
Tube length 100 m/3937"	802 843

Accessories

10 m/30 feet LDS extension

3

Used to extend the LDS probe by 10 m/30 feet.
Part No: 090216



Headphone connector

4

With the headphone connector, the operator can connect a headphone to its detector.

Part No: A459818

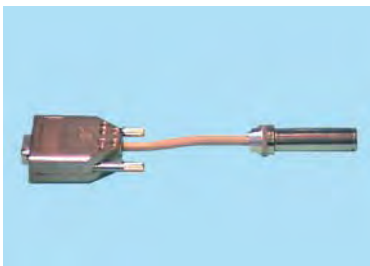

The headphone connector is an accessory but to use it, the detector must be equipped with the interface board option.

Which headphone used  C 410

Transport cart

5

ASM 182 range
Part No: 111196



Accessories

Transport cart (ctd) ASM 142 range
It can be fixed to the detector.
Part No: 108068

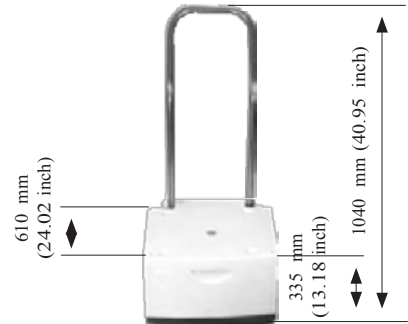

ASM 142 range
In addition to the standard cart (p/n 108068), a 4 wheels stainless steel cart is proposed for 142 series.
Part No: 802862



Foot pedal for cycle command (1.5 m/ 5 feet) Part No: 100913

6



Accessories

Calibrated Helium leaks

7

There are several types of calibrated leaks, with or without reservoir, with or without valve, covering several leak ranges. The choice of the appropriate external calibrated leak depends on the application requirements.

For further information on the ALCATEL calibrated leaks, please refer to our product catalog or consult your local ALCATEL sales engineer.

Most of the ALCATEL calibrated leaks are delivered with a calibration certificate.



Helium 3 and Hydrogen calibrated leaks

ALCATEL does not supply the calibrated leaks in Helium 3 and Hydrogen.

Principle

All ALCATEL calibrated leaks are based on permeable membrane technology.

Recalibration

Most calibrated leaks last many years even though the helium is permanently escaping (the leak rate is very small in comparison to the amount of helium contained in the reservoir: yearly loss is indicated on the calibrated leak identification label).

However, it is recommended to have every calibrated leak (with reservoir) recalibrated on regular intervals to validate its value: this is applicable for both internal and external calibrated leaks.

Recalibration period of the calibrated leak depends on its leak rate value.

Recommendation for proper Quality Control:

THE RECALIBRATION INTERVALS SHOULD NOT EXCEED 2 YEARS.

Please consult your local Alcatel Sales representative for additional information.

Calibration accessory

8

Used to connect the calibrated leak and the sniffer probe for a calibration.

Model	Part No
DN 16	110 715
DN 25	110 716



Accessories

Spray probe

9

Helium spray probe.
Part No: 109951

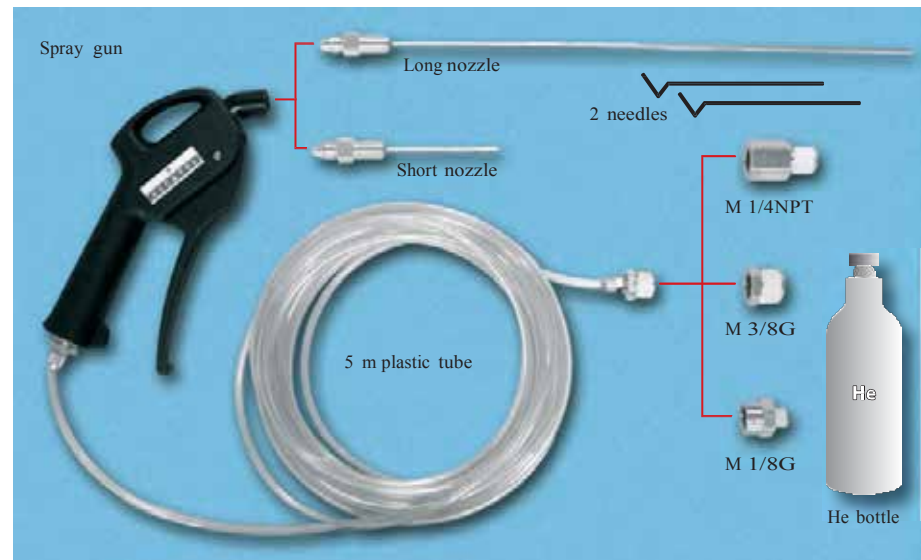

Spraying Helium in order to detect a leak is usually very easy, especially if you need fast and rough detection.

Spraying Helium could also become a technical challenge when you need to pinpoint very fine leaks, more so, when they are located in areas with difficult access.

The Helium spray gun is an easy to use and multipurpose tool which allows you to work in various conditions of test:

- Multi standard: thanks to the 3 different adapters to be connected to the Helium bottle (M 1/4 NPT, M 3/8G and M 1/8G)
- Multi purpose: thanks to the 2 nozzle lengths of 80 mm / 3.14 inch and 290 mm / 14.4 inch
- Standard leak mode: for quick and rough leak tests
- Fine leak mode.

The Helium spray gun is provided with 2 standard needles which allow the adjustment of the Helium flow at the outlet of the nozzle.

Inlet adaptor

10

Adaptator plug is necessary to connect the calibrated leak to the inlet part (test chamber) of the detector.

Part No: 067791

Printer

11

ALCATEL does not supply the printers. The printer should be connected to the leak detector and have the following characteristics:

- RS232 serial type
- 40 columns minimum.

Accessories

Inlet filters

12



Designation	DN Flange	Part No
70 µm stainless steel mesh filter	16	072 721
70 µm stainless steel mesh filter	25	072 857
70 µm stainless steel mesh filter	40	067 636
20 µm inlet filter	25/25	105 841
20 µm inlet filter	40/40	105 842
20 µm inlet filter	40/25	105 843
5 µm inlet filter	25/25	105 844
5 µm inlet filter	40/40	105 845
5 µm inlet filter	40/25	105 846
20 µm inlet filter	Ø 114 mm	105 847
5 µm inlet filter	Ø 114 mm	105 848
O'ring, Ø 5 mm	Ø 114 mm	082 152

Short distance sniffer probe (to be connected to the inlet part of a leak detector):

Temperature coefficient: 7 % per °Celsius.

Standard leak rate: $2 \cdot 10^{-4}$ mbar.l/s

Able to measure helium concentration inside water or liquids.

13



Designation	DN Flange	Part No
Sniffer probe with membrane, DN 40 flange and a 1.5 meter tube (5 ft)	40	067 683
Sniffer probe with membrane, DN 40 flange	40	067 677
Sniffer probe with membrane, DN 25 flange	25	103 592
Sniffer probe with membrane and 14 mm O.D. smooth tube connection	Ø 14 mm	067 678

Accessories

Bombing chamber

14	Designation	DN Flange	Part No
	Bombing chamber 10 bars (Ø 150 - L 200 - Vol. : 3.5 l)	-	786 396
	Bombing chamber 25 bars (Ø 150 - L 200 - Vol. : 6.4 l)	-	786 397
	Adaptator DN 25 to USA 1 1/8 OD tube	25	795 716
	Adaptator DN 40 to USA 1 1/8 OD tube	40	067 890

Test chambers (required interface board)

- small test chamber : hemispherical test chamber, Ø 72 mm, depth 31 mm

- medium test chamber : cylindrical test chamber, Ø 85 mm, depth 68 mm

15

- large test chamber : cylindrical test chamber, Ø 160 mm, depth 100 mm



Designation	Part No
Small test chamber DN 25 (1)	802 452
Small test chamber DN 40 (2)	802 453
Small test chamber DN 50 (3)	802 454
Medium test chamber DN 25 (1)	802 455
Medium test chamber DN 40 (2)	802 456
Medium test chamber DN 50 (3)	802 457
Large test chamber DN 40 for ASM 182 T/TD+	802 458
Large test chamber DN 40 for ASM 192 T/TD+	802 459
Large test chamber DN 50 for ASM 192 T2/T2D+	802 460

(1) ASM 142 - ASM 142 D - ASM 122 D

(2) ASM 122 D - ASM 182 T/TD+ - ASM 192 T/TD+

(3) ASM 192 T2/T2D+

Accessories

Neutral gas vent line kit Part No: 801421

16



Neutral gas vent line kit

4 swiveling wheels kit Soft wheel : improve the mobility
(Ø 125 mm) Customers have the possibility to lock
1, 2, 3 or 4 wheels independently.

17

Part No: 801846



Accessories

Covered sniffer probe
and remote control kit

18

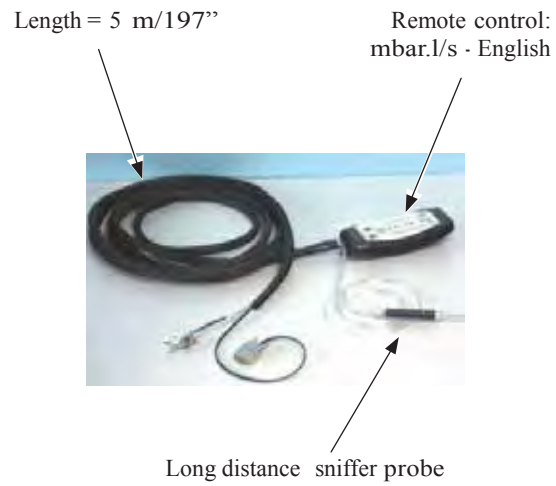

Part No: 802844

Bottle handle for cart

19

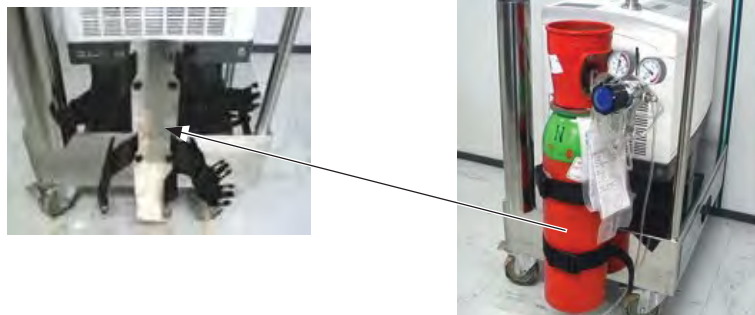

Bottle handle for cart p/n 111196
Part No: 802819

ASM 142 S

Technical characteristics

	Measurement range (Helium)		Crossover pressure (at inlet)	
	mbar.l/s	Pa.m ³ /s	mbar	Pa
Sniffing test mode	1.10 ⁻⁷ to 1.10 ⁻¹	1.10 ⁻⁶ to 1	sniffer probe at atm. pressure	
Sniffing test mode (concentration)	0.1 ppm to 100 %			
Response time (without LDS extension and without adaptator)	< 1 s			
Response time (with 10 m/32 ft LDS extension)	< 5 s			

Adaptator for calibrated leak  C 306

Analyzer cell (Spectro):

Principe cellule d'analyse	self protected 180° magnetic deflection mass spectrometer
Analyzer cell filament	2 tungsten filaments
Analyzer cell sensitivity	3.10 ⁻⁴ A/mbar
Emission current range	0.2 to 2 mA

Audio alarm: 90 dB frequency modulated and adjustable audio signal

Sniffing Audio set point	1.10 ⁻¹⁹ to 9.9.10 ¹⁹
--------------------------	---

Start-up time (average, at 20 °C):	2 min ± 10 %
------------------------------------	--------------

Miscellaneous:

Power voltage	low voltage :	100 - 130 V ± 10%
	high voltage :	200 - 240 V ± 10%
Power frequency	50/60 Hz single phase	
Power consumption (maximum)	500 W	
Start-up temperature	10 to 45° C	
Ambient operating temperature	0 to 45° C	
Storage temperature	-25° C to 70° C	
Noise level (at 1 meter; audio alarm not operational, stand by mode)	57 dBA	
House protection level	20C IP	
Weight	55 kg / 121 lb	

Dimensions (mm/inch)

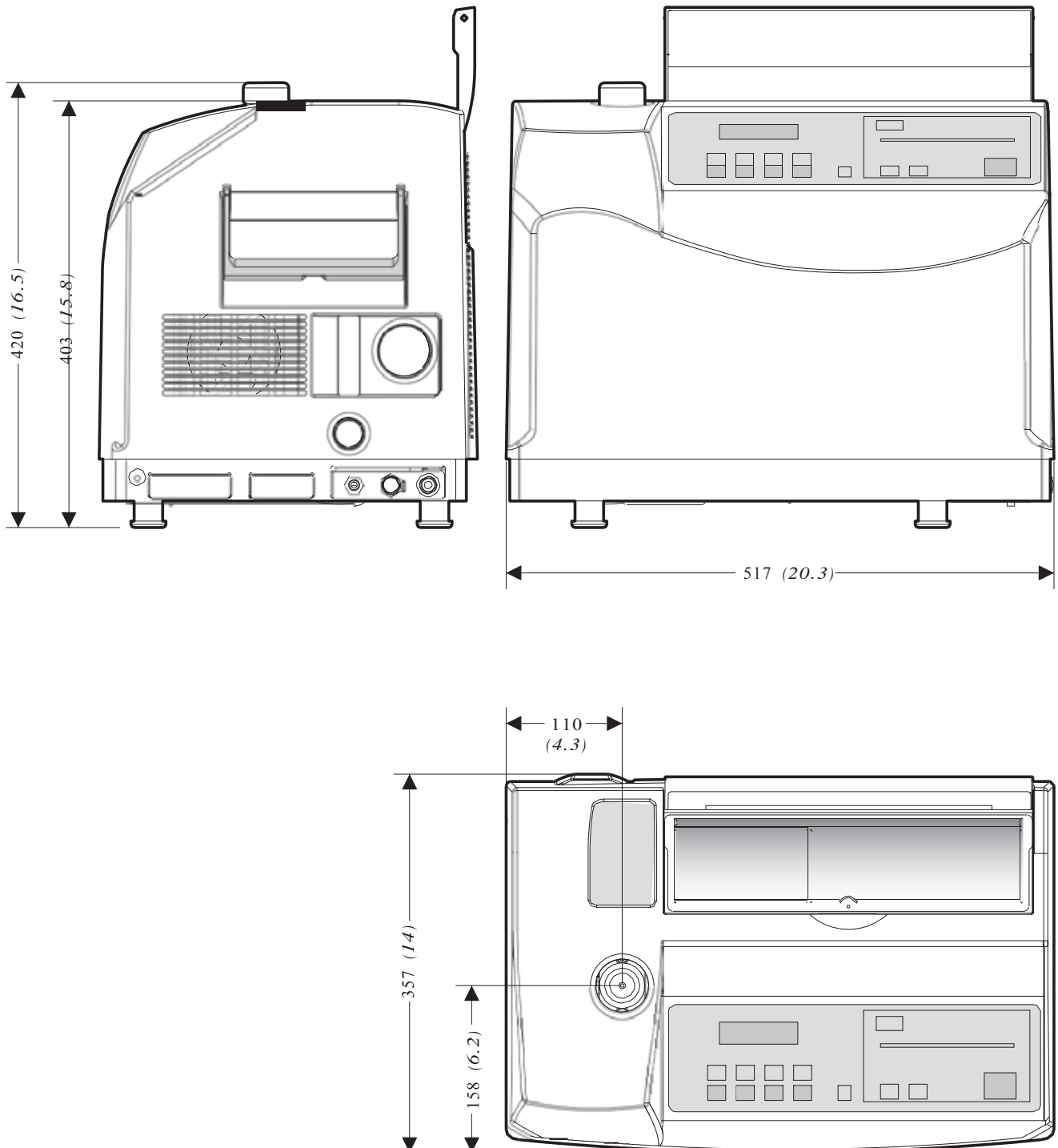



Preliminary remarks Throughout this User's Manual, you could find this type of message "Summary of screen  C 140": it refers to a specific chapter of the User's Manual. Please read it for further information.

B 100

Safety instructions

- Generalities
- Pump labels
- Leak detector labels
- Alcatel contact in case of emergency

B 110

Unpacking - Storage - Transportation

- Unpacking
- Supplies
- Storage
- Fixed mounting
- Transport

B 200

Neutral gas purge and inlet vent connection

- Products concerned
- Connection to the leak detector
- Use
- Gas characteristics

B 210

Connecting the detector to the installation

B 300

Controlling the detector with the I/O interface

- Purpose of the I/O interface
- Location of the I/O interface
- Prepare the connector wiring
- The controls (inputs)
- The signals (outputs)
- 24 V DC Power supply

B 310

Controlling the detector with a PC computer through the RS 232 interface

- Purpose of the PC computer interface
- Location of the RS 232 interface
- RS 232 interface instructions
- Commands available for your leak detector



ASM 142 S User's Manual Detailed contents

B 320

Connecting the detector directly to a printer or another device

- Purpose of the printer interface
- Location of the printer interface
- Connector description
- Communication mode description
- Connection to the printer
- Tickets available

B 400

Before starting up the leak detector

- Check power voltage
- Check the oil level of the rotary vane pump (ASM 142 - ASM 142 S)
- Installation

Safety instructions

Generalities

- Our products are designed to comply with current EEC regulations. Any modification of the product made by the user is liable to lead non-compliance with the regulations, or even to put into doubt the EMC (ElectroMagnetic Compatibility) performance and safety of the product. ALCATEL declines any responsibility for such operations.
- The EMC performance of the product is obtained on the condition that the installation complies with the EMC rules. In particular, in disturbed environments, it is essential to:
 - use shielded cables and connections for interfaces,
 - stabilize the power supply line with meshing from the power supply source to a distance of 3 m from the product inlet.



Risk of toppling: although the products comply with ECC regulations, it is important to take precautions to avoid toppling during handling, installation and operation.



Certain detectors are fitted with oil pumps: the oil load needed for pump operation is in separate cans. We also recommend that the user drains the pump before re-shipping the equipment.



When relevant, remove the protection which blocks the outlet of the pump, on the rear of the leak detector. We recommended connecting this outlet to a gas evacuation circuit for the oil seal pump. This circuit should have as little excess pressure as possible (less than 0.3 bar).



Storage of the equipment: our equipment can be stored without special precautions for up to 3 months (room temperature between 5°C and 40°C). For longer periods, factors such as humidity content, temperature, salty atmosphere, etc., can cause damage to certain «sensitive» parts (elastomer seals, lubricant, etc.).



Check the pumping conditions of the detector: the leak detectors are not equipped for pre-pumping of corrosive gases, condensable vapours of liquids, even in small quantities.

Safety instructions



Alcatel can not take any responsibility or apply any warranty on a leak detector which is used with a presence of corrosive or dangerous gases: all our leak detectors are not designed to pump dangerous substances.



A helium leak detection operation must be made in a safe environment for the user and the equipment: all precautions must be taken by the user of the leak detector in that respect (especially to eliminate the presence of chemical, aggressive, toxic or hazardous substance prior to the test operation). Alcatel has no control over the types of gases passing through the pumps.



Ensure that parts or enclosures connected to the inlet of the detectors can handle a pressure drop of 1 bar relative to atmospheric pressure.



If the detector rotates in an axis perpendicular to the axis of rotation of the secondary pump, there is a risk of seizure of the secondary pump.



When the device is switched off, avoid touching the pins of the mains plug. Residual voltages due to filter capacitors can provoke an electrical shock.



When the main electrical switch on the detector is set to «0», the part supply between the power plug and the main switch remains energized.

Risk of electrical shock in case of contact.

Disconnect main electrical cable before servicing.



Hazardous voltage enclosed.

Voltage or current hazard sufficient to cause shock.

Disconnect and lockout power before servicing.

Any intervention must be done by trained personnel only.



When the leak detector is switched off, internal parts (monitoring, frequency converter) contain capacitors charged with over 60 VDC and remain energized.

Electrical shock may result in severe injury.

Wait 5 minutes after switching off before opening the leak detector.

Safety instructions



Other located hazardous energies: Nitrogen purge, pressurized hazardous energies. Release pressure before servicing, disconnect the gas line quick connector and turn off the pressure regulator by turning the knob counter-clockwise.

*Operating conditions may generate temperatures justifying particular attention on the part of the user (external surfaces > 70°C on exhaust connections).
Contact may cause burns.
Always use gloves before servicing.*

Pump labels

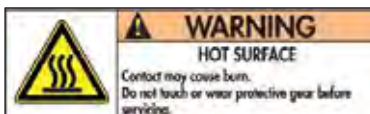

Located on the rear of the pump, this label warns the user against possible risk of injury due to any hand contact with hot surfaces. It states that protective gloves should be used before performing any intervention.

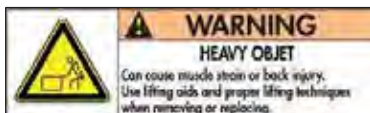

Located on the upper cover, this label indicates that due to its heavy weight, the product should not be handled manually, but always through appropriate handling devices.

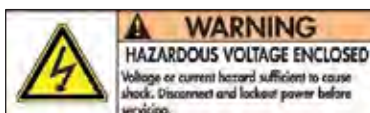

Located on the upper cover, this label indicates that some of the internal parts are energized and could cause electrical shocks in case of contact. It advises to disconnect the pump before any intervention or to properly lock-out and tag-out the equipment breaker before any intervention on the pump.

Leak detector labels

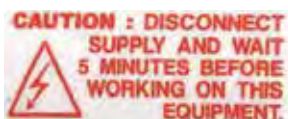

Located near the main power switch, this label indicates that after disconnecting power supply, the operator should wait 5 minutes before working on the leak detector.

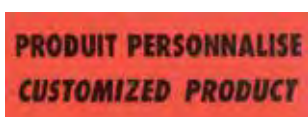

Located near the main power switch, this label indicates that the product has been customized in factory, according to customer order.



Located at the top of the frame, near the exhaust port, this label indicates that the exhaust port should not be blocked.

Safety instructions

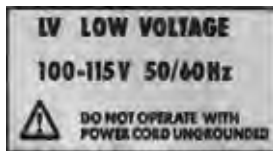

Located near the main power switch, these labels indicate the leak detector power voltage

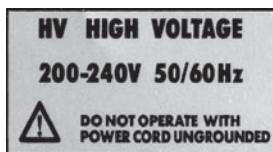

DISCONNECT BEFORE MAINTENANCE
DEBRANCHER AVANT ENTRETIEN

Located near the main power switch, this label indicates that the main power cable should be disconnected before maintenance.



This label indicates that the leak detector is conformed to the R.O.H.S. directives.



Located near the main power switch, this label indicates the part number of the leak detector and its serial number.

NOTICE
PUMP IS SHIPPED WITHOUT
● OIL INSTALLED
consult maintenance manual
CAUTION

Recto

Located on the cover, this label indicates that the product has been drained before leaving factory.

ATTENTION
POMPE LIVREE SANS HUILE
● A L'INTERIEUR
consulter le manuel d'utilisation
ATTENTION

Verso

It should be fill with oil before running.

Safety instructions

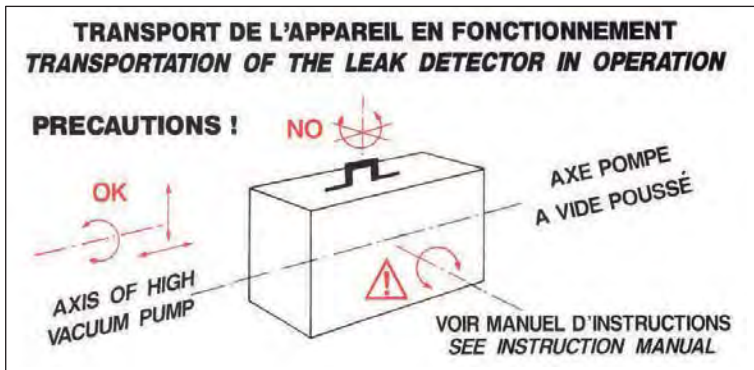

Located at the upper cover, this label indicates that the leak detector could not be moved in all positions.



(a)



(b)

Located inside (a) or outside (b) the packaging box, this tilt indicator indicates that the box has been tipped.

Alcatel contact in case of emergency

In case of emergency or equipment failure, please contact your service manager of your local service center (see addresses at the back of the manual).

Unpacking - Storage - Transportation

Unpacking

When the equipment is received, unpack it carefully: do not discard the packaging until you have made sure that the unit has not been damaged during transport. Check the packaging tilt indicator of the detector. Before opening, check the name of the model and the serial number.

Use an hoist equipped with slings attached to the leak detector handles to extract it from its packaging.



Note:
If the operator doesn't use an hoist, 2 people are necessary to extract and carry the leak detector.

Weight :  A 800

Notch for handling hook

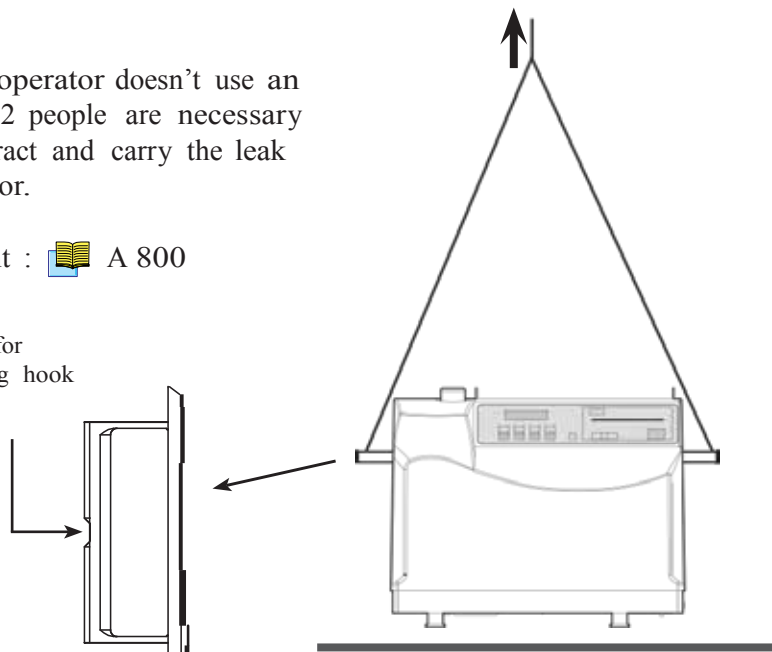

In the event of an anomaly, take the necessary action with the shipper and notify Alcatel if necessary.

Unpacking - Storage - Transportation

Supplies The following parts are supplied with your detector:

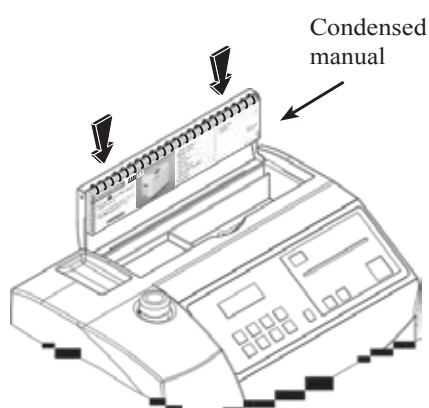

SUPPLIES	ASM 142	ASM 142 S	ASM 142 D
User's Manual ASM 142 / 142 D	x		x
Condensed manual ASM 142 / 142 D	x		x
User's Manual ASM 142 S		x	
Condensed manual ASM 142 S		x	
Oil + Funnel	x	x	
A calibration certificate of the internal calibrated leak	x	x	x
1 allen wrench # 5	x	x	x
1 screwdriver	x	x	x
1 vacuum hose	x	x	
1 vacuum connector	x	x	
Stickers units		x	
1 allen wrench # 2,5		x	
1 LDS probe		x	
Manual RS 232 (option)	x	x	x

If one of these parts is missing, contact ALCATEL immediately.

Storage For prolonged storage, factors such as temperature, humidity, saline atmosphere, etc. may damage the detector elements.

Please call your local representative for further information.

Before starting up after storage for over six months, it is recommended to change all the seals (contact customer service).

The seals kits must be kept away from heat and light (direct sunlight and ultraviolet light) in order to prevent hardening of the elastomers.

Unpacking - Storage - Transportation

Fixed mounting The ASM 142 can be fixed on a support: a threaded hole is available on the bottom of the unit to place a screw to keep it secure to a working surface such as a bench.

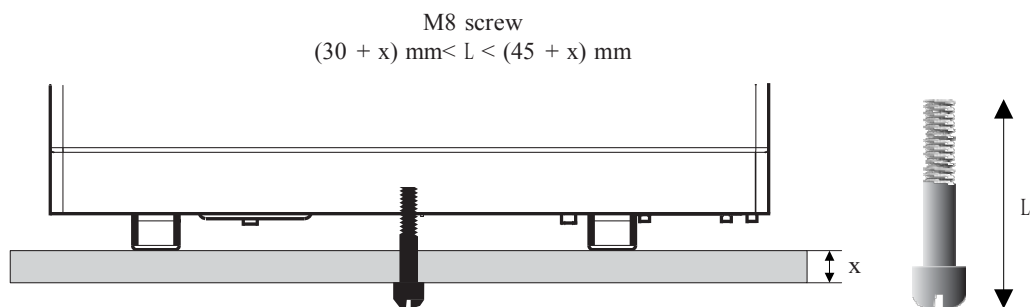

Transport Before expedition, we advise you to drain the primary pump to avoid any oil split (except ASM 142 D).

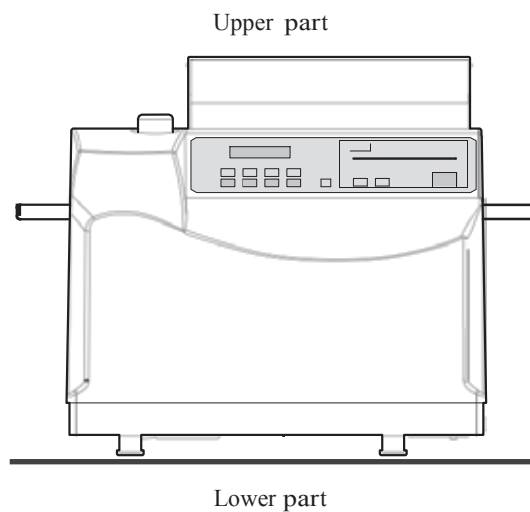

Primary pump maintenance  E 750

Neutral gas purge and inlet vent connection

Products concerned

Products concerned	Inlet vent	Neutral gas purge
ASM 182 / 192 T ASM 192 T2	✓	
ASM 182 / 192 TD+ ASM 192 T2D+	✓	✓ (2)
ASM 142	✓ (1)	
ASM 142 D		✓ (MDP 5006 HDS)(3)
ASM 142 S ASM 102 S		
ASM 122 D	✓	✓ (2)
ASM 1002	✓	

(1) Requires a special inlet vent kit installation ( A 700).

(2) Male connector delivered with the leak detector.

(3) Male connector not delivered with the leak detector.

Model : Male connector R 1/4 BSPT.

Connection to the leak detector

 B 210 / B 211

Neutral gas purge

If no purge system is connected, the neutral gas purge is connected to the ambient air and maintained an air flow inside the leak detector.

Even if the leak detector does not use the neutral gas purge, the male quick connector delivered with the leak detector should always be connected to the female free flow quick connector (ASM 122 D only).

Inlet vent

The inlet vent status (open or closed) depends on the parameters set by the operator ( C 500).

If no inlet vent system is connected, the inlet vent is connected to the ambient air.

Neutral gas purge and inlet vent connection

Use

Neutral gas purge Used to accelerate the cleanup of the helium background noise in the pumps after detecting a significant leak.

Make high sensitivity testing easier due to the decreasing and stabilization of the helium background noise.

As a supplement to the neutral gas purge, use the “Depollution” function ( C 560).



In case of a big flow of Helium into the leak detector (very big leak detected), the recovery time (time for the display to go back to normal Helium background value) is 10 times longer when the neutral gas purge is obturated than when it is open. In usual average test conditions, there is however no major difference.

Inlet vent Used to accelerate the cleanup of the helium background noise in the leak detector after detecting a significant leak.

Make high sensitivity testing easier due to the decreasing and stabilization of the helium background noise.

Allows to regulate the gas flow inside the leak detector, leak detector in stand-by.

Gas characteristics

Type Nitrogen is typically the neutral gas used but you can use any gas on the condition that it is poor in helium (concentration ≤ 1 ppm). Take care with the ambient air: it should not be polluted with helium.

Quality/purity According to the installation or item to test. The gas should be clean, dry, without dust, no toxic.

Use pressure 0.3 ± 0.1 bar relative (≈ 20 psia).



If the inlet vent pressure is too high, the inlet valve will always stay closed.

Purge flow ASM 122 D - ASM 142 D: ≤ 5 sccm
ASM 182 TD+: ≤ 50 sccm

Connecting the detector to the installation

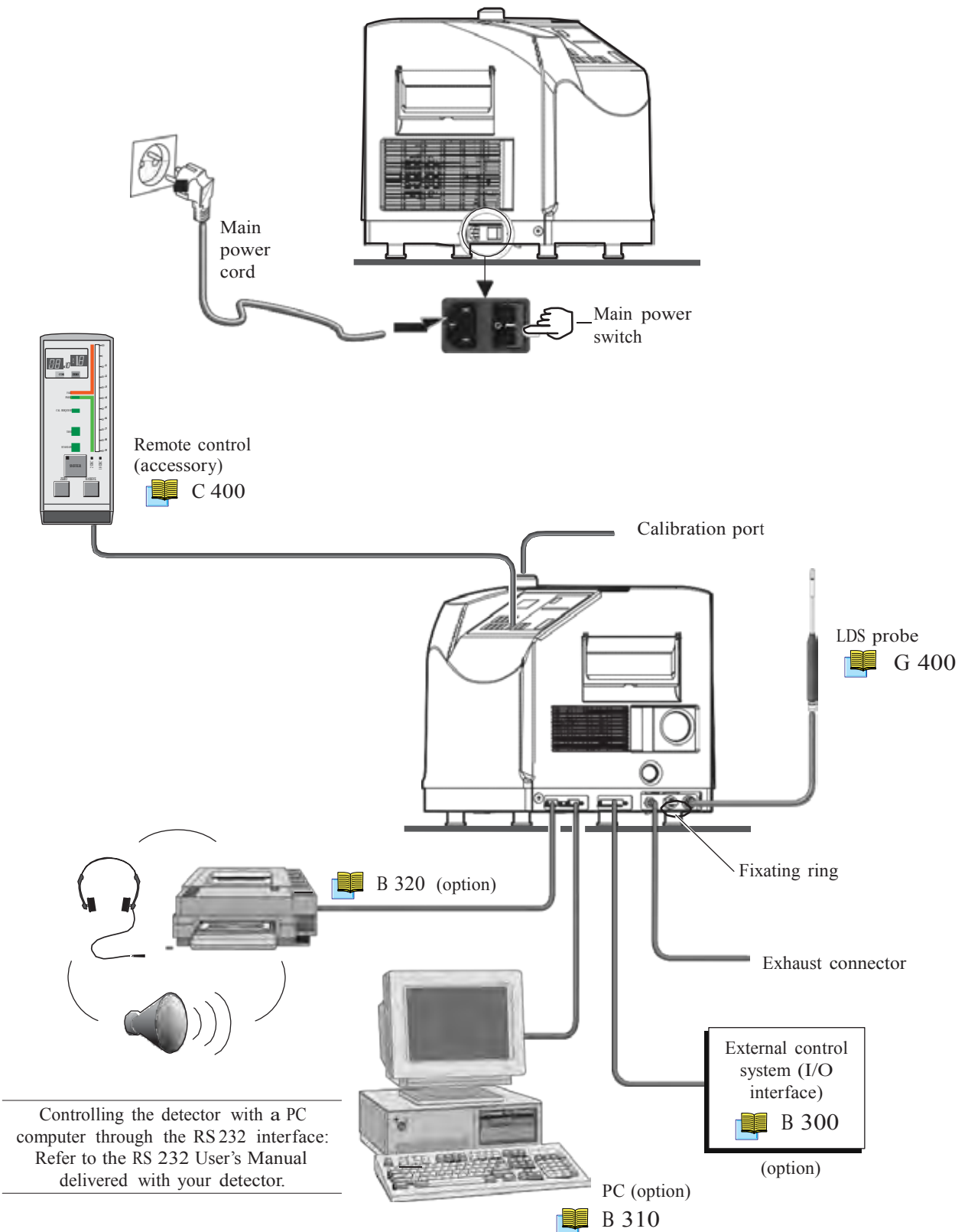

Controlling the detector with the I/O interface

Purpose of the I/O interface

The I/O interface makes it possible to control the leak detector with a PLC or any other external control device.

Location of the I/O interface

The I/O interface is available on a Sub D 25 pin Female connector located on the back of the leak detector.

Prepare the connector wiring

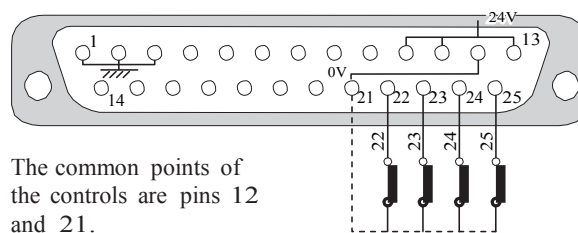

The common points of the controls are pins 12 and 21.

B 210

It is recommended to use a shielded cable which is grounded on the connector cap.

The controls (inputs)

22 Sniffer	Sniffing start/stop [low level (contact closed) activation]
23 Autocal	Autocalibration: falling edge pulse [open-closed activation]
24 Zero	Zero function start/stop [low level activation]

The signals (outputs)

Dry contacts:
 Direct current: 60 V - 60 W or 2 A max
 Alternative current: 40 V - 125 VA or 2 A max
 Closed contact:

Pin #	State	Logic output	Type
8 - 9	Closed	Helium signal above Reject Setpoint SNIF	Dry contact Tolerated voltage from 0 to 240V maximum current 2A
7 - 20	Closed	Calibration	
6 - 19	Closed	Selected sniffer mode On	
5 - 18	Closed	Warning or Fault message	
4 - 17	Closed	Sniffing mode ON	

Pin #	Analog output	Type
1 - 14	Spectro Helium signal Logarithmic	0 - 8 V Log (1 Volt/...) without any correction factor
2 - 15	Corrected Helium signal Exponent	Voltage = Exponent absolute value + 2 0 - 10 V - 1 V per decade ; 10 ⁻¹⁰ = 10 V, 1 = 0 V
3 - 16	Corrected Helium signal Mantissa	Voltage = Mantissa value 0 - 10 V linear - ex.: 1.2 Volt = 1.2

Nota :

- 1 - 2 - 3 = internal ground
- 12 = common (external ground)
- 21 = common (external ground)

Controlling the detector with the I/O interface

24 V DC Power supply

Pin No	24 V DC power supply
10, 11, 13	If SW1 on P0307 interface board is closed (upper position) ⇨ +24V DC (maximum current 350 mA) supplied by leak detector If SW1 is open (lower position) ⇨ (+) point for customer external power supply (24 V)
12, 21	If SW1 on P0307 interface board is closed (upper position) ⇨ Ground If SW1 is open (lower position) ⇨ (-) point for customer external power supply

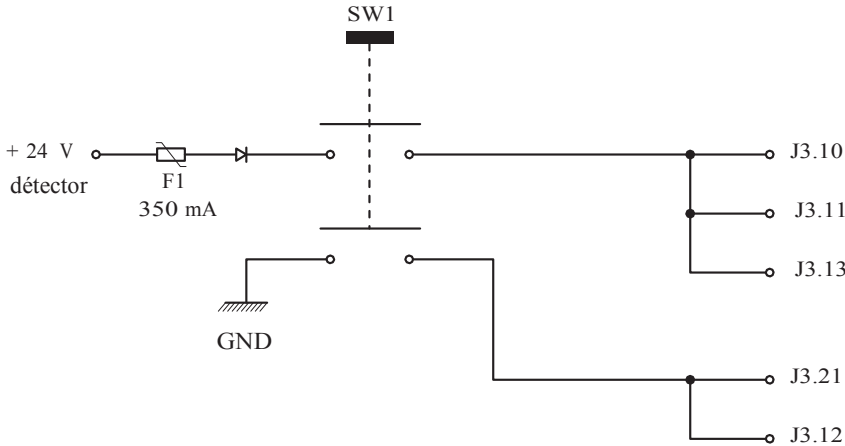

Controlling the detector directly by a PC computer through the RS 232 interface

Purpose of the PC computer interface The RS 232 interface makes it possible to control the leak detector with a PC compatible computer.

Location of the RS 232 interface It is a Sub D 9 pin Male connector.

Connect the detector to the installation  B 210/211

RS 232 interface instructions A specific manual describes to the operator all the commands available with the RS 232 Alcatel protocol. It is delivery with your leak detector.

Commands available for your leak detector Only the commands which correspond to the fonctions of your leak detector are available.

See details in the RS 232 User's manual.



Purpose of the printer interface

The Printer interface makes it possible to connect the leak detector to a printer, an external loudspeaker or a headphone.



Location of the printer interface

It is a Sub D 9 pin Male connector.

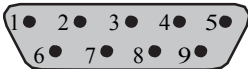
 B 210



Connector description

Pin #	Function	Communication protocol	
1 	External loudspeaker	Mode	Asynchronous
2	Rx	Bauds	9600
3	Tx	Bits	8
4	NA	Parity	None
5	Ground	Stop bit	1
6 	Headphone	Parity control	None
7	RTS		
8	CTS		
9 	Internal use only. Don't connect it		

Headphone and loudspeaker  C 410

Communication mode description



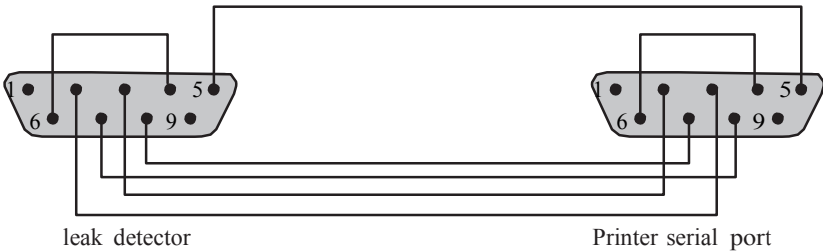

Configuration tickets are sent out.

Connection to the printer



Connecting the detector directly to a printer or another device

Tickets available

Ticket	Exemple	Impression
Configuration	1	Print from «T» RS 232 command
Internal calibration with internal leak (option)	2a	Automatic print after a calibration with internal/external leak: refer to  C 301
Internal calibration with external leak	2b	
Calibration with concentration	2c	Automatic print after a calibration with concentration: refer to  C 301
Calibration checking with a leak	3a	Automatic print after a calibration adjustment with a leak: refer to  C 302
Calibration adjustment with concentration	3b	Automatic print after a calibration adjustment with a concentration: refer to  C 302
Calibration source	5	Print from RS 232 «S» command
Current calibration status	6	Print from RS 232 «C» command

Nota : Whatever the selected language, the tickets are always printed in English, except if the French is selected (tickets in French).

Connecting the detector directly to a printer or another device

Configuration ticket

1

```

ASM142S CONFIGURATION TICKET
VERSION: L102v3.0 r10
DATE:Jan/01/2005  TIME:00:06:46

SET-POINTS MENU
reject point:                1.0E-04
audio level:                 3
digital voice level:        2
sniffer probe clogged reject: 1.0E-06
sniffer probe length (meter): =5
auto standby time span(h/m): 01/00
zero function use:          operator
zero auto capture every (m:s): 00:10
start.timer value(m:s):    00:10

SPECTRO MENU
calibration key:            on
calibration check every(h/m): 12/00

*****

Calibration Source Parameters:      std
.....
type:                               internal leak
value:                              1.9E-05
unit:                               mbar.l/sec
date:                               Jan/2005
depletion rate (%/year):            2.30
calibration temperature(Celsius):   24
temperature coefficient (%/C):      2.00

*****

filament in use:                   1
electronic zero:                   40
acceleration voltage(V):           224
electronic current(mA):             0.6
sensitivity coefficient:            00.39
MAINTENANCE MENU
high vac.mnt.periodicity(hours):   12000
high vac. mnt.due in(hours):       12000
customed mnt.period.(hours):       12000
customed mnt.due in(hours):        12000
filament#1 running time(hours):    0
filament#2 running time(hours):    0
.....
Current Calibrated Leak for:       He
recalibration delay span(month):   12
recalibration previous date:       Jan/2006
.....

```

```

OTHER MENU
*****
Preset Param. File for:            customize
analog display bargraph:          2 decades
blinking led for rejectpoint:      no
digit.display used for:            reject_pt
digital display out of test:       no
.....
Preset Param. File for:            standard
analog display bargraph:          10 decades
blinking led for rejectpoint:      yes
digit.display used for:            leak_rate
digital display out of test:       no
.....
current displays preset:           standard

*****

display language:                  english
lds basic unit:                    mbar.l/sec
lds working unit:                  mbar.l/sec
password value:                    5555
user interface:                    4
rs232 interface use: :              basic
rs232 handshake:                   no
TYPICAL VACUUM VALUES
Pu_gf :                            1.00000
Mu_rld:                            00042.0
DATE AND TIME VALUES
last stop:                         Jan/01/2005 00:00:00
last start:                        Jan/01/2005 00:00:03
last calib.ok:                     Jan/01/2005 00:05:03
detector counter (h:m:s):           00000:07:310

```

Connecting the detector directly to a printer or another device

Internal calibration with
internal leak (option)

2a

```

DATE:Jan/01/2005  TIME:00:04:25
ASM142S CALIBRATION gas:                He
sniffer probe length (meter):           =5
unit:                                    mbar.l/sec

CALIBRATED LEAK PARAMETERS:
type:                                    internal leak
value:                                    1.9E-05
unit:                                    mbar.l/sec
calibration year:                        Jan/2005
loss per year(%):                        2.30
calibration temperature(C):              24
temperature coefficient(%/C):            2.00
TARGET PARAMETERS:
current internal temperature(C):          26
target value:                             2.0E-05
ELECTRONIC ZERO:
done:                                      no
PEAK SEARCH   :
search                                                yes
SIGNAL RECORDS(no calibrated):
global:                                             6.8E-05
background:                                        1.7E-05
CALIBRATION INFORMATIONS:
total time(sec):                                  68
result:                                           COMPLETED

CURRENT ASM142S CALIBRATION:
DATE:Jan/01/2005  TIME:00:04:25
Fil:1 Ie=0.6 Vacc=224 Coef_sens:00.39

```

Internal calibration with
external leak

2b

```

DATE:Jan/01/2005  TIME:00:04:25
ASM142S CALIBRATION gas:                He
sniffer probe length (meter):           =5
unit:                                    mbar.l/sec

CALIBRATED LEAK PARAMETERS:
type:                                    internal leak
value:                                    1.9E-05
unit:                                    mbar.l/sec
calibration year:                        Jan/2005
loss per year(%):                        2.30
calibration temperature(C):              24
temperature coefficient(%/C):            2.00
TARGET PARAMETERS:
current internal temperature(C):          26
target value:                             2.0E-05
ELECTRONIC ZERO:
done:                                      no
PEAK SEARCH   :
search                                                yes
SIGNAL RECORDS(no calibrated):
global:                                             6.8E-05
background:                                        1.7E-05
CALIBRATION INFORMATIONS:
total time(sec):                                  68
result:                                           COMPLETED

CURRENT ASM142S CALIBRATION:
DATE:Jan/01/2005  TIME:00:04:25
Fil:1 Ie=0.6 Vacc=224 Coef_sens:00.39

```

Connecting the detector directly to a printer or another device

Calibration with
concentration

2c

```

DATE:Jan/03/2005  TIME:10:16:27
ASM142S CALIBRATION gas:           He
sniffer probe length (meter):     =5
CONCENTRATION REFERENCE
target value:                      5.0E-06
ELECTRONIC ZERO:
done:                              no
PEAK SEARCH   :
search        :                    no
SIGNAL RECORDS(no calibrated):
global:                    5.3E-06
CALIBRATION INFORMATIONS:
result:                    COMPLETED

CURRENT ASM142S CALIBRATION:
DATE:Jan/03/2005  TIME:22:12:53
Fil:1  Ie=0.6  Vacc=234  Coef_sens:00.95

```

Calibration adjustment with
a leak

3a

```

CALIBRATION ADJUSTMENT INFORMATIONS:
DATE:Jan/01/2005  TIME:00:05:04
current internal temperature(C):    26
current coef.sens:                  00.39
global rate:                        2.48E-05
background rate:                    5.53E-06
calibrated leak-rate:               1.92E-05
target value:                       1.98E-05
Calibration Adjustment Coefficient:
authorized low value:                0.85
authorized high value:               1.15
CURRENT VALUE:                      1.03

```

Calibration adjustment with
concentration

3b

```

CALIBRATION ADJUSTMENT INFORMATIONS:
Calibration source:  concentration
DATE:Jan/03/2005  TIME:10:19:31
current coef.sens:    00.95
concentration rate:   5.19E-06
target value:        5.00E-06
Calibration Adjustment Coefficient:
authorized low value: 0.85
authorized high value: 1.15
CURRENT VALUE:       0.96

```

Connecting the detector directly to a printer or another device

Calibration source

5

```
*****
Calibration Source Parameters:   He
.....
type:                           external leak
value:                           1.1E-05
unit:                             mbar.l/sec
date:                             Jan/2004
depletion rate (%/year):         2.00
calibration temperature(Celsius): 23
temperature coefficient (%/C):    2.00
.....
type:                           concentration
value:                           5.0E-06
.....
type:                           internal leak
value:                           1.9E-05
unit:                             mbar.l/sec
date:                             Jan/2005
depletion rate (%/year):         2.30
calibration temperature(Celsius): 24
temperature coefficient (%/C):    2.00
.....
*****
Calibration Source Parameters:   Hy
.....
type:                           external leak
value:                           1.2E-05
unit:                             mbar.l/sec
date:                             Feb/2002
depletion rate (%/year):         2.00
calibration temperature(Celsius): 20
temperature coefficient (%/C):    0.20
.....
type:                           concentration
value:                           1.0E-05
.....
*****
```

ASM 142 S
only

```
*****
Calibration Source Parameters:   He3
.....
type:                           external leak
value:                           1.3E-08
unit:                             mbar.l/sec
date:                             Mar/2003
depletion rate (%/year):         3.00
calibration temperature(Celsius): 20
temperature coefficient (%/C):    3.00
.....
type:                           concentration
value:                           5.0E-08
.....
*****
Calibration Source Parameters:   He
.....
type:                           external leak
value:                           1.4E-05
unit:                             mbar.l/sec
date:                             Jan/2004
depletion rate (%/year):         2.00
calibration temperature(Celsius): 23
temperature coefficient (%/C):    2.00
.....
type:                           concentration
value:                           5.0E-06
.....
type:                           internal leak
value:                           2.4E-05
unit:                             mbar.l/sec
date:                             Jan/2005
depletion rate (%/year):         2.30
calibration temperature(Celsius): 24
temperature coefficient (%/C):    2.00
.....
*****
```



ASM 142 S
only

Current calibration status

6

```
DATE AND TIME VALUES
last calib.ok:      Jan/01/2005 00:04:25
last ajust.ok:     Jan/01/2005 00:05:04
Detector stop:     Jan/01/2005 00:00:00
Detector start:    Jan/01/2005 00:00:03
CALIBRATION PARAMETERS
Fil:1 Ie=0.6 Vacc=224 Coef_sens:      00.39
Adjustment calib. coefficient=        1.03
```

Before starting up the leak detector

Please acquaint oneself with the safety instructions sheet ( B 100) and the installation sheet ( B 110)

The performance of the detector (pumping speed, accuracy and reliability) depends on:

- the vacuum connections
- the frequency and quality of maintenance
- the helium calibration.

Check power voltage

Check that the power voltage is compatible with the power configuration of the leak detector: check the indications of the label located close to the power switch.

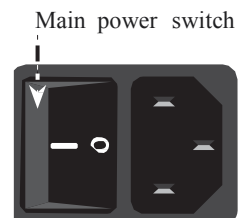

Check the oil level of the rotary vane pump (ASM 142 - ASM 142 S)

The pump has been drained: a label affixed on the cover of the unit indicates this and the filling oil is supplied.

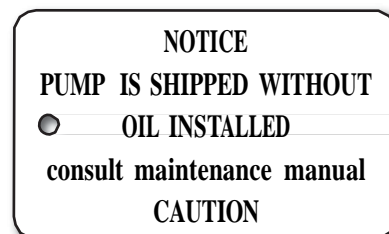

Recto

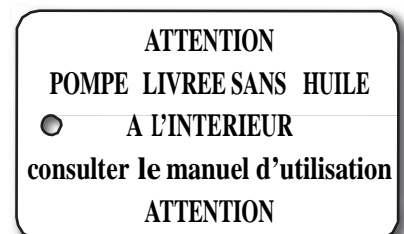

Verso

Maintenance of the primary pump  E 750



The pump will be damaged if it runs without oil. (> 5 mn).



The oil required for the first use is supplied with the detector. Replacement of oil is the user's responsibility. The pumps have been tested with ALCATEL 200 oil. The technical characteristics of the pump are guaranteed only with the recommended oil.



Installation

Position the unit so there is no possible risk of it falling or tilting.



ASM 142 S User's Manual Detailed contents

Preliminary remarks Throughout this User's Manual, you could find this type of message "Summary of screen  C 140": it refers to a specific chapter of the User's Manual. Please read it for further information.

C 100	<i>Factory configuration of the leak detector parameters</i>
	- Parameters configuration
C 110	<i>Operating principle of the control panel</i>
	- General - Control keys - Menu selection access keys - Parameters keys - Access level - Description of access key - Values adjustment with the control panel
C 120	<i>Setting and maintenance part presentation of the control panel</i>
	- Setting and maintenance part - Levels - Parameters setting and application depending on level of the user interface
C 130	<i>Access to level  - Password</i>
	- To access to level  - Change password
C 140	<i>Summary of screens</i>
	- Other menu - Spectro menu - Set point menu - Maintenance menu
C 200	<i>Starting up / Switching off the leak detector</i>
	- Starting up after an unused/storage period - Starting up the leak detector - Switching off the leak detector

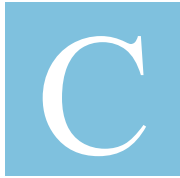

C 211

Operation of the leak detector

- How to use your leak detector?
- 3 detector states
- Sniffing test
- Display
- Reject Threshold
- Sniffer probe

C 213

Display

- Analogic display
- Digital display
- Displays setting

C 300

Calibration of the leak detector

C 301

Basic internal calibration of the leak detector

- Purpose of the calibration
- Different types of calibration
- When should calibration be performed?
- Internal calibrated leak
- Calibration procedure

C 305

Calibrated leak values programming

- Different types of calibrated leaks
- Programming the calibrated leak parameters

C 306

Adaptator for calibrated leak

- How to use the adaptator?

C 400

Remote control

- Remote control interface
- Remote control connecting
- Units
- Users levels
- Use and display

C 410

Headphone and loudspeaker

- Level adjustment
- Accessories ?
- Configuration



ASM 142 S User's Manual Detailed contents

C 430

3 masses option

- Purpose
- Gas selection
- Calibration in Hydrogen or Helium 3

C 450

Long distance sniffer probe and Helium spray gun

C 520

Audio alarm / Digital voice

- Audio alarm definition
- Digital voice definition
- General
- Sound level
- Adjustment

C 540

Zero function

- Purpose
- Procedure
- Activate/desactivate the zero function manually
- Zero function setting
- Audio level
- Display

C 570

Date - Time - Language - Unit

- Adjustment procedure

C 580

Fault / information indicator and display

- Fault and information
- Faults
- Information
- List of messages

C 590

Massive function

- Purpose
- Principle
- Preliminary conditions
- Start/Stop of the massive function

Factory configuration of the leak detector parameters

Parameters configuration

The following list indicates the factory configuration of the leak detector parameters.

When the leak detector is switched off, all set parameters are memorized and values are kept for the next start-up.

We advice you to note in the “Customer modification“ column, the parameter values modified for your application.

Parameters		Configuration		
		Factory	Customer modification	
Rs232	Mode	Basic		B 310
	Handshake	no		B 310
Test	Reject point	1.0E-04(*)		C 211
Sniffer probe	Clogged	1.0E-06(*)		C 211
	Length (feet)	> 49		C 211
	Response time (s)	10		C 211
Standby	Timer (h/m)	01/00		C 211
Display	Test info	standard		C 213
	Bargraph	10 decades		C 213
	Blinking led used for reject point	yes		C 213
	Used for	leak_rate		C 213
	Active out of test	no		C 213
Autocalibration	Autocal key	on		C 301
	Source	int. leak		C 301
	Timer (h/m)	12/00		C 301
Calib. source (ASM 142 S with int. cal. leak option only)	Type	int. leak		C 305
	Value	See the calibration certificate of the calibrated leak delivered with the detector.		C 305
	Unit			C 305
	Calib. date			C 305
	Depl. rate (%/yr)			C 305
	Calib. temp (°c)			C 305
	Temp. coeff. (%/°C)			C 305

(*) in mbar.l/s. If you use another unit, this value will be automatically converted in this unit.

Factory configuration of the leak detector parameters

Parameters		Configuration		
		Factory	Customer modification	
Calib. source	Type	ext. leak		C 305
	Value	1.1E-05(*)		C 305
	Unit	mbar.l/s		C 305
	Calib. date	01/01/2006		C 305
	Depl. rate (%/yr)	2.0		C 305
	Calib. temp (°C)	24		C 305
	Temp. coeff. (%/°C)	02.00		C 305
3 Masses	Spectrometer gas	He		C 430
	Audio	3		C 520
	Digital voice	4		C 520
Zero option	Automatic	no		C 540
	Capture	Timer		C 540
	Timer (m/s)	00:10		C 540
	Language	English		C 570
	Date	Factory leaving		C 570
	Time			C 570
Unit	Basic	mbar.l/s		C 570
	Extra	no		C 570
	Cor. value	1		C 570
Menu access	Password	5555		C 130
	Level	4		C 130
Maintenance	Primary pump initial value	5000 H		D 200
	High vac. pump initial value	12000 H		D 200
	Customized initial value	12000 H		D 200
Leak dates	Calib. date	01/01/2005		D 210
	Time (month)	24		D 210

(*) in mbar.l/s. If you use another unit, this value will be automatically converted in this unit.

Operating principle of the control panel

General

Operator interface  A 500

If a key (sensing switch) is depressed when its function is not available or not authorized, a brief audio signal is emitted.

Control keys



The LED indicator is ON when the control key is activated (ex.: Sniffer ON).



The LED indicator is OFF when the control key is deactivated (ex.: Sniffer OFF).



Menu selection access keys

The LED indicator comes ON after depressing the key. It activates the menu. Then the corresponding menu is shown on the alphanumeric display.



Pressing the corresponding Menu selection key a second time deactivates the menu. The LED indicator is then turned OFF and the previous screen is displayed again.

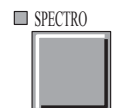

Menu selection access keys

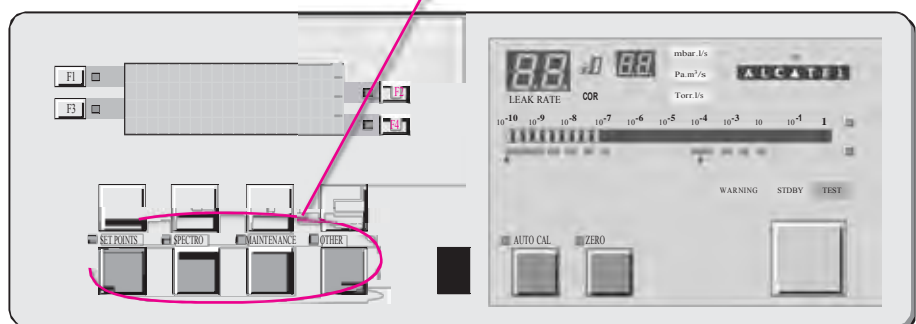

Operating principle of the control panel

Parameter keys

- To access to the parameter to be changed, there are up to 4 function keys available on the alphanumeric display





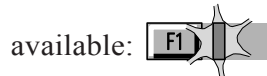

Only one parameter key can be activated at a time.

- The LED indicator is ON when the corresponding function key is available:

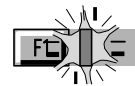

- Press on key: the indicator light flash:



The modification can be performed with ,  and  keys. At this stage, it is always possible to cancel the modification in progress and reset the previous value by pressing  key.





Otherwise, once the desired value is obtained, pressing the function key again validates it: the LED indicator remains ON and











stops flashing.

Access level

Following the user's level set, the operator will have access to different control panel keys.  C 120

- Level 1**  All the control panel keys are locked except ,  and  keys which are necessary to set the password if necessary. If you press a control panel key, the password is requested. After the password validation, all the control panel keys are unlocked provisionally.  C 130

- Level 2**  Only , ,  and  are locked. If you press a control panel key, the password is requested. After the password validation, all the control panel keys are unlocked provisionally.  C 130

- Level 3**  All the control panel keys are unlocked. Some parameters access will request the password.  C 130

- Level 4**  Total access to the control panel keys.

Operating principle of the control panel

Description of access keys



Next menu or next step of a function, Next PARAMETER DIGIT, WARNING/ERROR message display on the LCD when an error is detected.



Resets original parameter value (before flashing of the Fx setting line) and deactivates the parameter key.

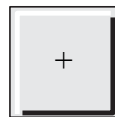

YES, or ON, or OPEN, or active, or increase value, or increase audio volume, or select more sensitive test mode.

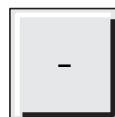

NO, or OFF, or CLOSE, or deactive, or decrease value, or decrease audio volume, or select less sensitive test mode.



Values adjustment with the control panel

In many menus, some values can be adjusted (reject point, password, timer, ...). Please follow the procedure described below.

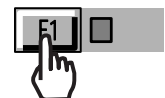
Procedure Press function key of the desired line (where the value needs to be adjusted).



Nota :

- The cursor positions on the most important digit and not the first.
Example : 1.0E-04  The cursor positions on the 4th digit.
- For the digital values, it will be necessary to adjust each digit individually using the  key .

For each parameter, use modification keys in order to adjust the value and go to the next parameter.



Repeat the same operation as needed.

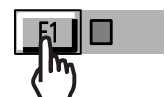

After the last modified parameter, press again the function key to validate the change.

Setting and maintenance part presentation of the control panel

The control panel can be divided into two different sections.

- The section located on the right of the control panel is dedicated to the operator. All users with a user level higher than 1 have access to this section.
- The section located on the left of the control panel dedicated to the setting and maintenance (adjustments, functions, menu access, etc.).

Operator interface  A 500

Setting and maintenance part

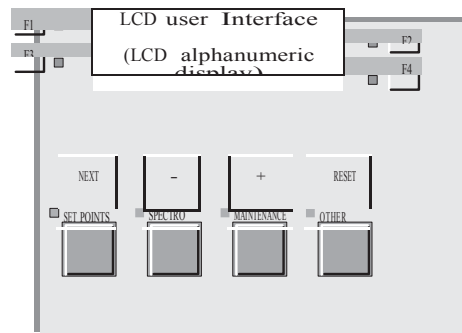

- The detector offers 4 user interface levels for this section to accommodate any application requirements.

Levels

Description

Levels	Description
Levels 1 and 2	These levels don't allow the access to the menus except with password ( C 130).
Level 3	Same as levels 1 and 2 but with possibility to set some parameters. This level is generally selected for maintenance applications.
Level 4	This level allows access to all the menus and is generally used for settings all the parameters.

Setting and maintenance part presentation of the control panel

Which is your user interface level?

In order to find out what is the current interface level, follow the sequence described below:



PARAMETERS MENU
ACCESS PASSWORD

OR WAIT 9 SEC

⇒ If this screen appears, your access level is **1**

LANGUAGE : ENGLISH
TEST INFO : STANDARD
DATE : FEB/06/2005
TIME : 07:079:22

⇒ If this screen appears, your access level is **2**

LANGUAGE : ENGLISH
TEST INFO : STANDARD
DATE : FEB/06/2005
TIME : 07:079:22

⇒ If this screen appears, your access level is **3**

LANGUAGE : ENGLISH
TEST INFO : STANDARD
DATE : FEB/06/2005
TIME : 07:079:22

⇒ If this screen appears, your access level is **4**

To change user interface level

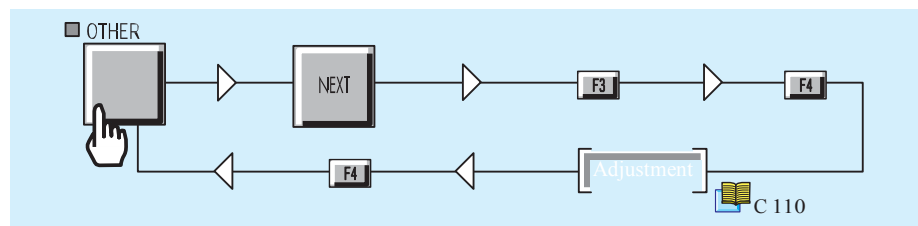

Level **4** access





A 300

Setting and maintenance part presentation of the control panel

Parameters setting and application depending on level of the user interface

Function (with its associated parameters)		User Interface				Detector	
		Level required for setting parameters				ASM 142 S	ASM 102 S
		Level 1	Level 2	Level 3	Level 4		
RS 232	RS 232 User's Manual				✓		
User interface	C 120				✓	✓	✓
Password	C 130				✓	✓	✓
Sniffer probe clogged threshold	C 211				✓	✓	✓
Sniffing reject point	C 211			✓	✓	✓	✓
Display	C 213				✓	✓	✓
Auto-calibration (setting)	C 301				✓	✓	✓
Calibrated leak	C 305				✓	✓	✓
Audio alarm	C 520			✓	✓	✓	✓
Digital voice	C 520			✓	✓	✓	✓
Zero function	C 540				✓	✓	✓
Date · Time · Language · Unit	C 570				✓	✓	✓
Massive function	C 590				✓	✓	✓
3 masses option	C 430				✓	✓	✓
Maintenance required	D 200 / 210				✓	✓	✓
Filament information	E 400				✓	✓	✓

Access to level 4 - Password

Some difficulties with the control panel use/access ?			
Operating principle of the control panel	 C 110	Access to level 4 - Password	 C 130
Setting and maintenance part presentation of the control panel	 C 120	Summary of screens	 C 140
Access to parameters and parameters active depending on authorization		Complete displays list with access way and associated sheet	

Access to level 4 Procedure to apply to pass from level 1 / 2 / 3 to level 4 .

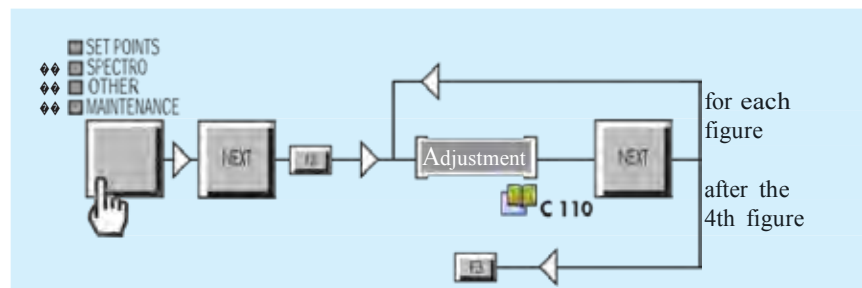

The operator has now reached the level 4
The software will automatically come out of level 4 and go back to the previous used level.

Change password

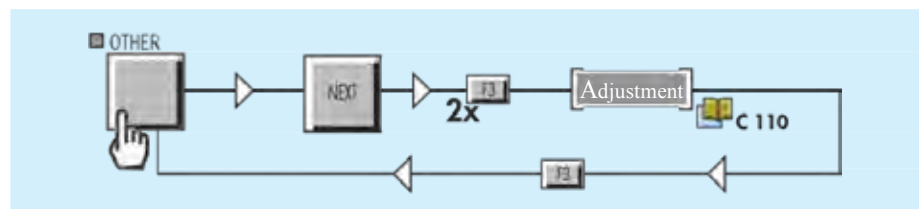

Summary of screens

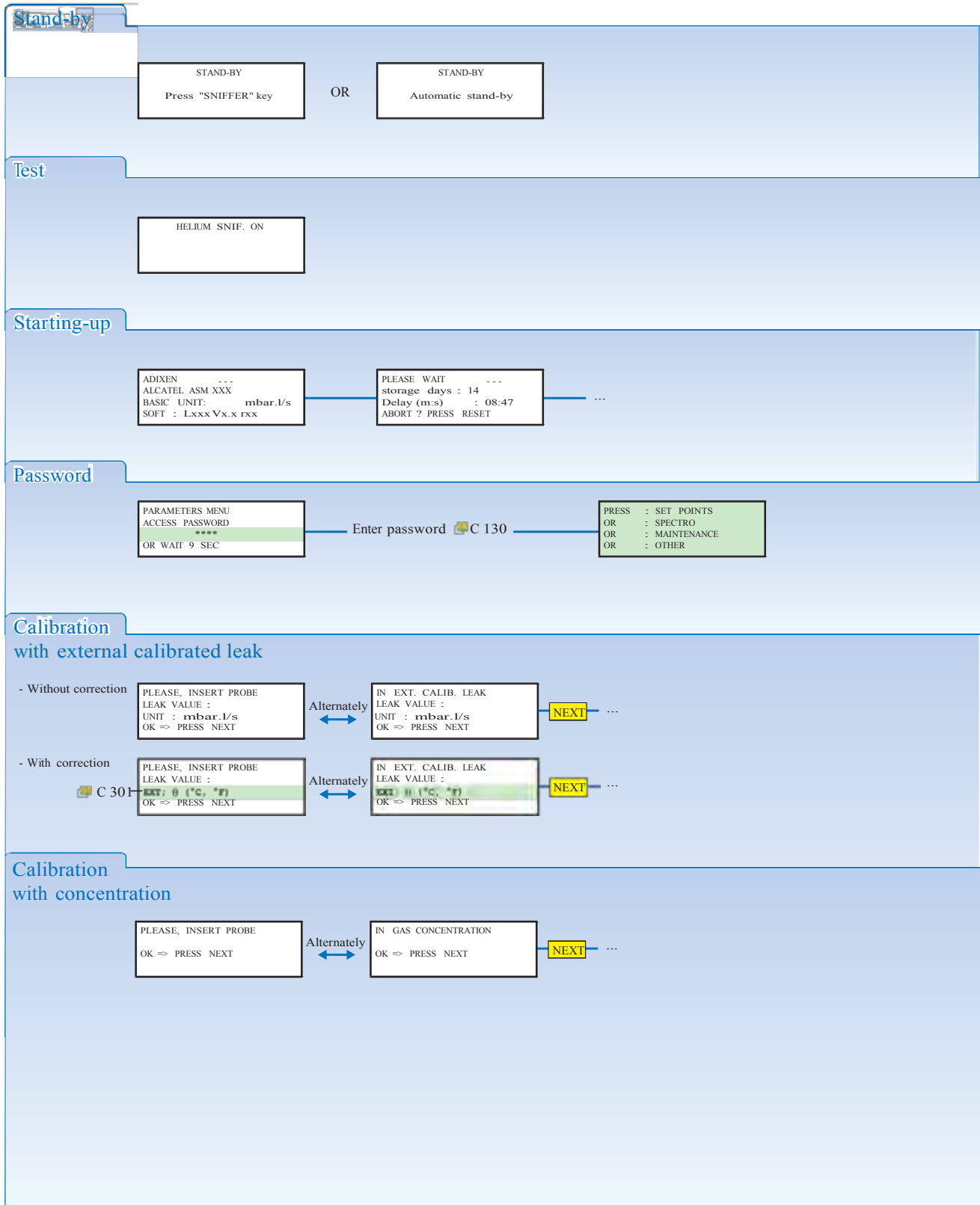

Summary of screens

Other Menu

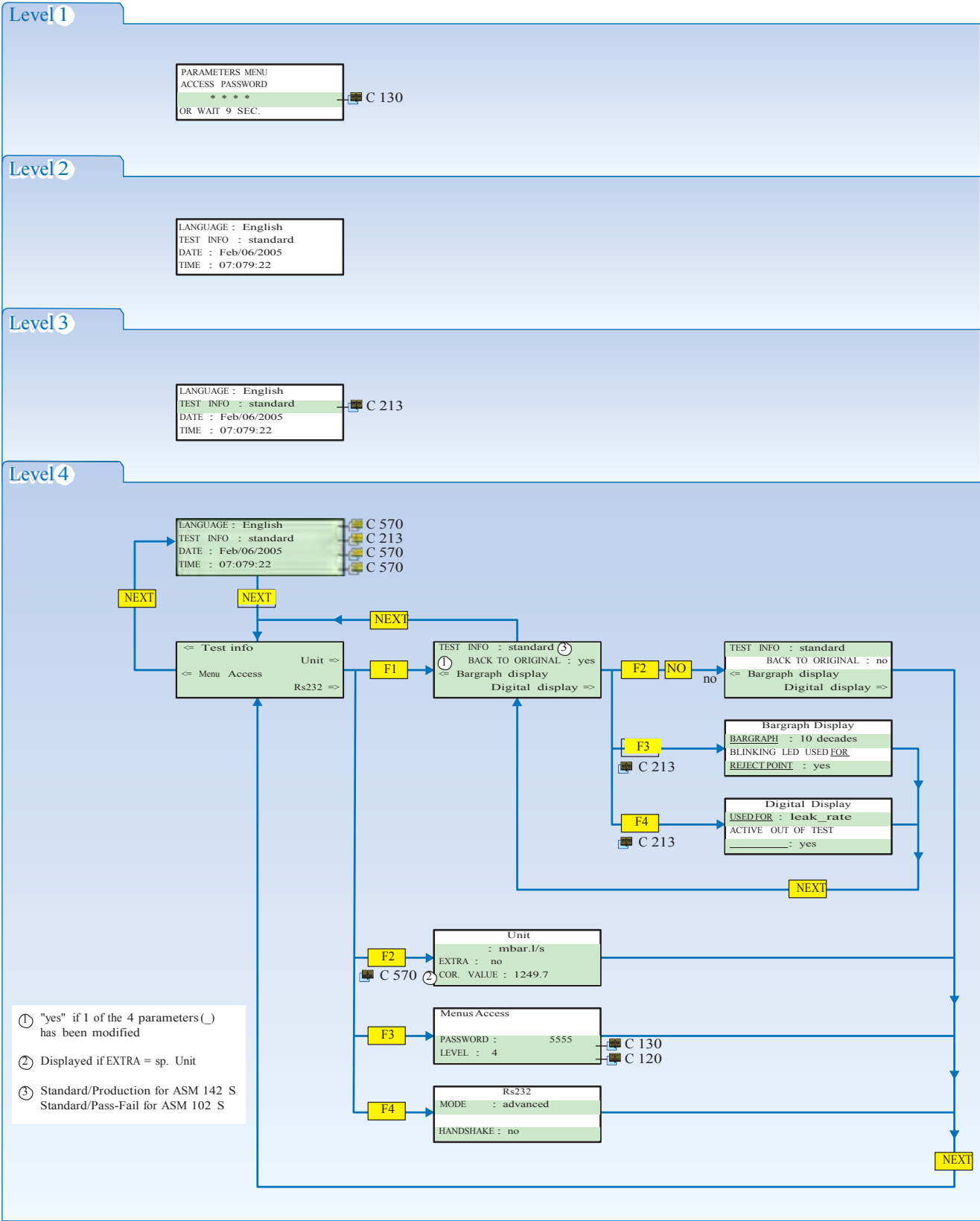

Summary of screens

Spectro Menu

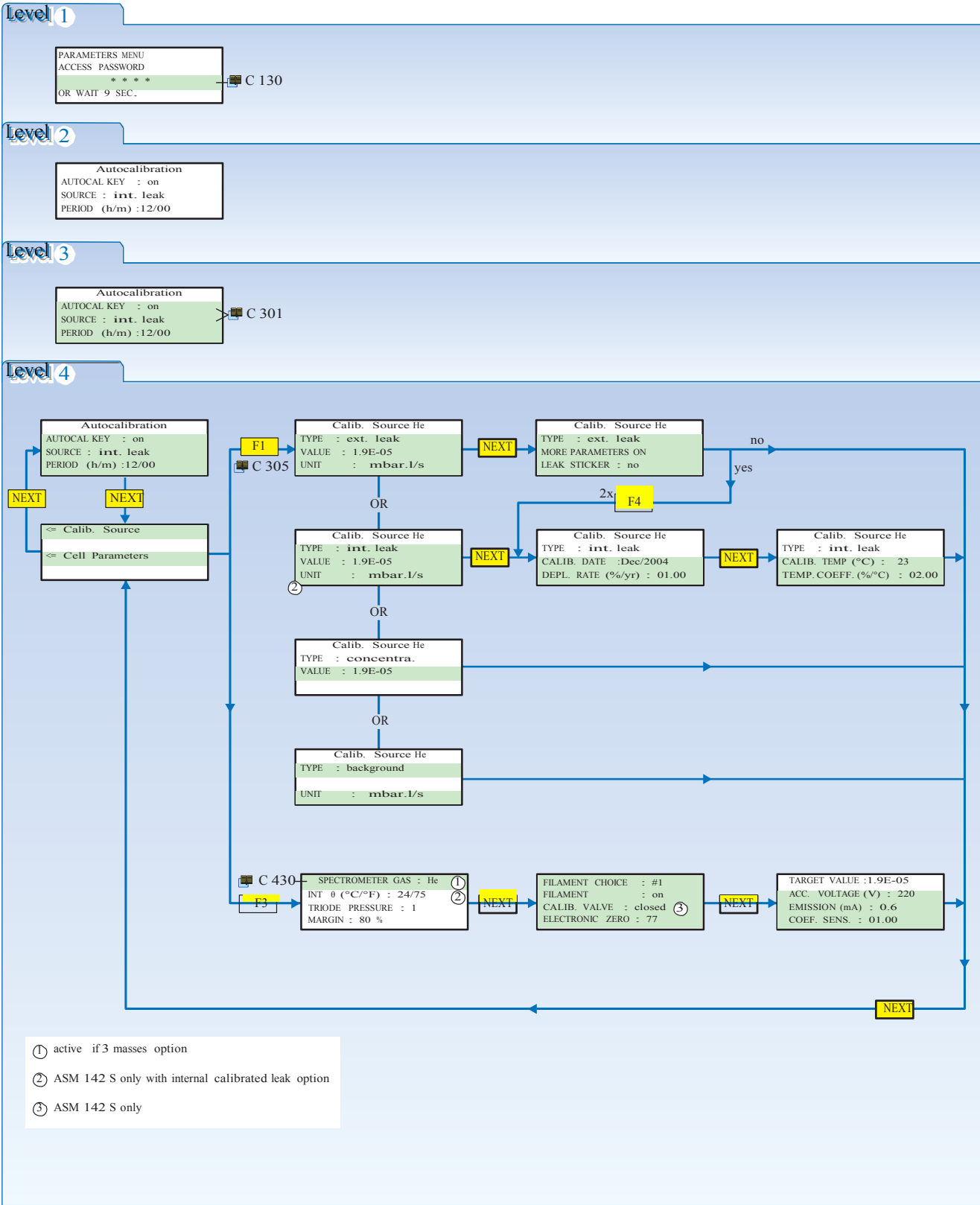

Summary of screens

Set point Menu

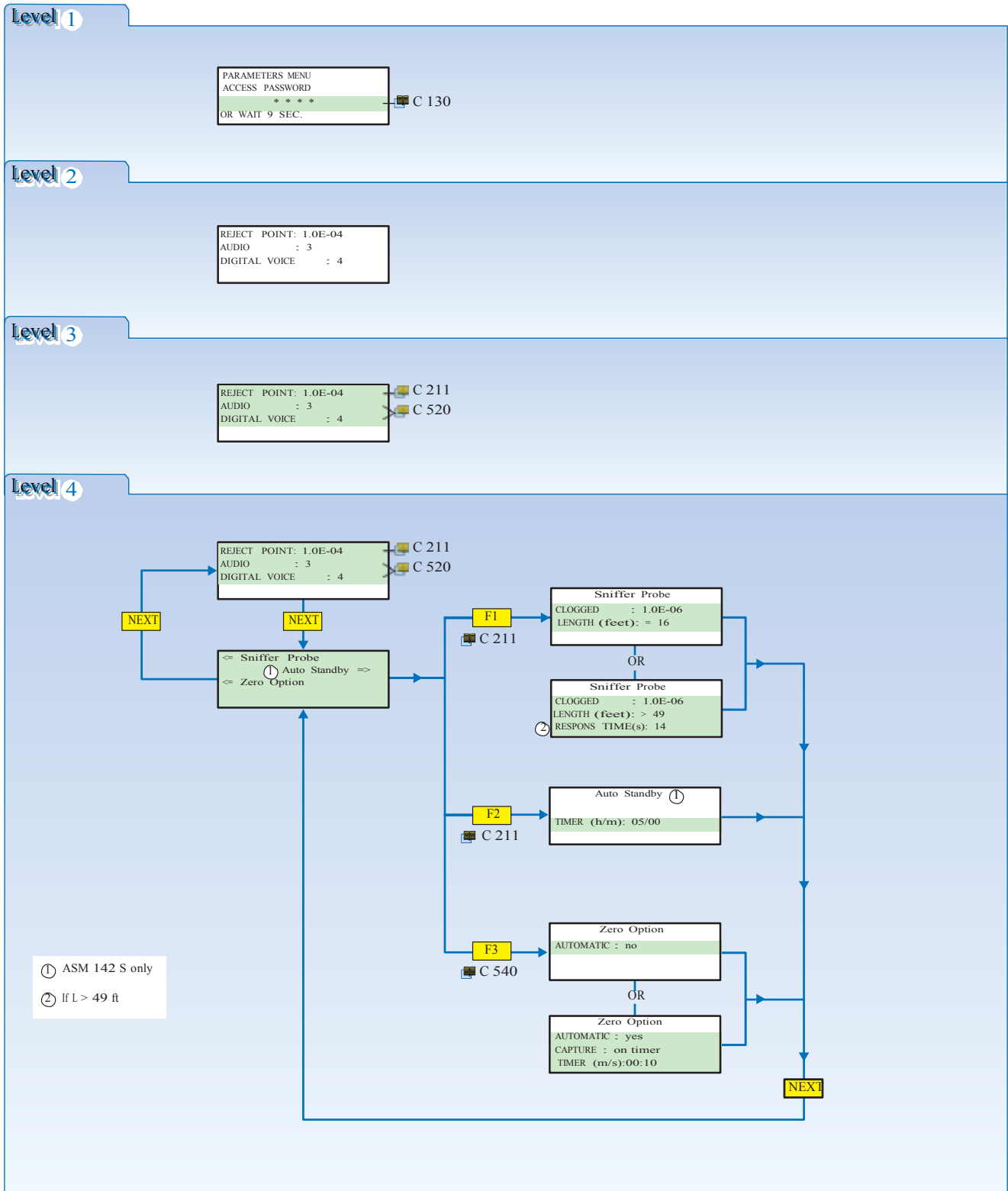

Summary of screens

Maintenance Menu

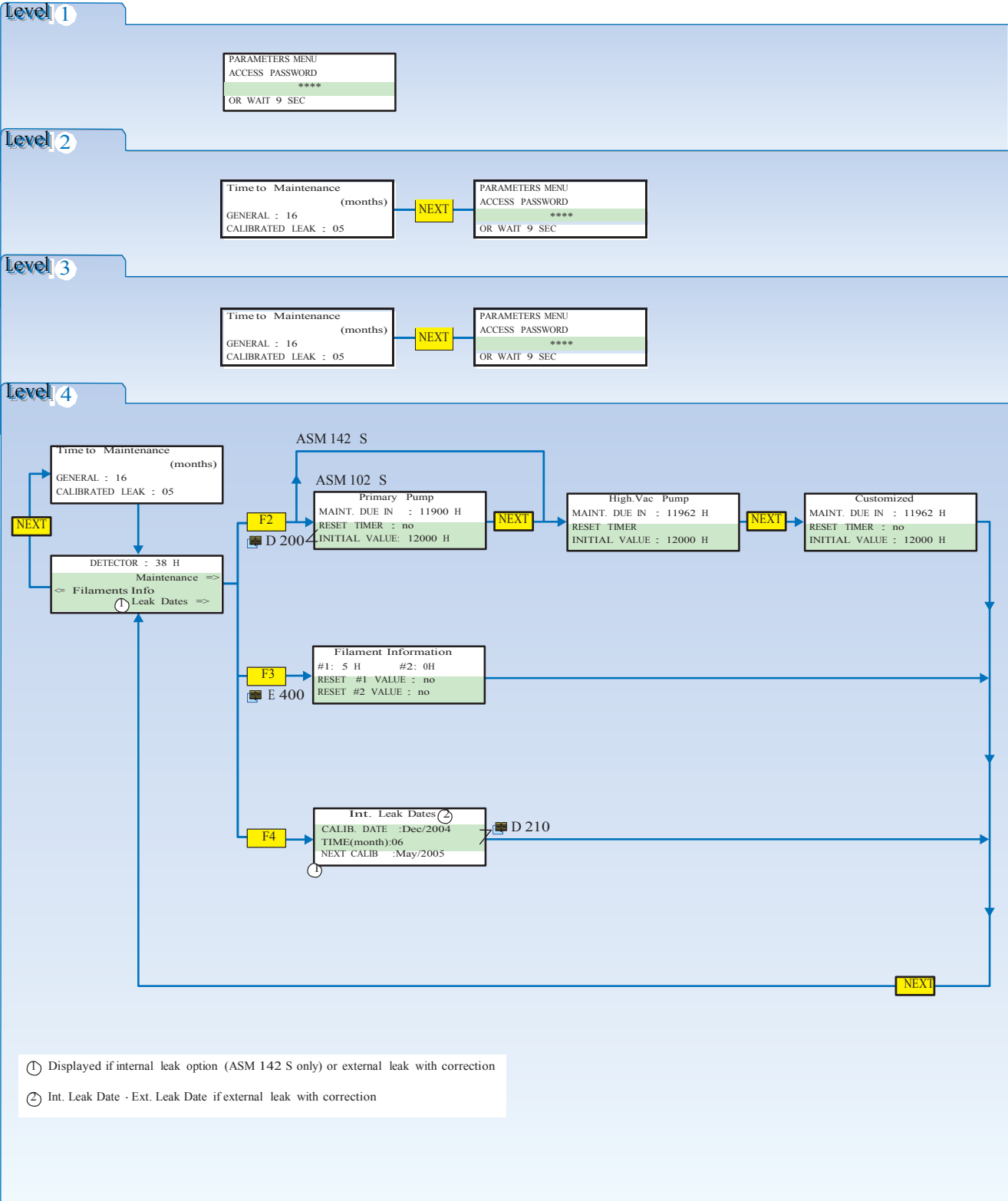

- ⌚ Displayed if internal leak option (ASM 142 S only) or external leak with correction
- ⌚ Int. Leak Date - Ext. Leak Date if external leak with correction

Starting up / Switching off the leak detector

Starting up after an unused/storage period

• If the operator uses the leak detector, after an unused or storage period, there is an additional time at the normal start-up time for outgassing:

- 10 days < inactivity period ≤ 24 days ⇨ + 3 mn
- inactivity period > 24 days ⇨ + 15 min

Technical characteristics  A 800

• A screen informs the operator in the start-up process:

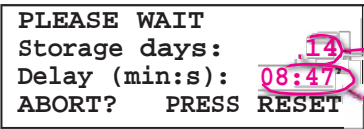

Number of days since the last leak detector switching off

Count down of the additional time



The operator can cancelled this additional time by pressing

Starting up the leak detector

Before starting up the detector  B 400.

Connect the main power cable of the detector to the proper power outlet.

Turn main power switch in the ON position ( B 210). The primary pump starts instantaneously. Wait a few minutes the appearance of the next screen:

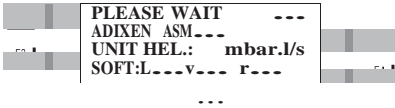

Audio messages inform the operator about starting-up process during this one.

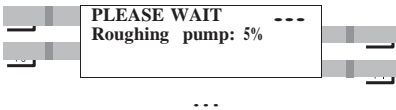

This screen indicates the turbomolecular pump starting up.

Wait the synchronism.

Starting up / Switching off the leak detector

Starting up of the leak detector
(continued)

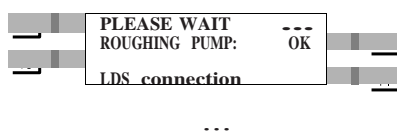

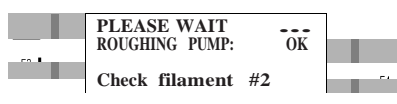

This screen indicates that the pump is with synchronism and the probe is in connection process.

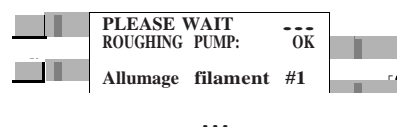

This screen indicates that the filament 2 is in checking process.



This screen indicates that the filament 1 is in starting up process.

After a 10 s temporisation, the screen , the green light  and the vocal message «detector ready» indicate that the detector is ready to be used. (if any calibration request warning «i» is activated).

Nota: After the leak detector start, the «AL» message appears in the digital display if the background measured is lower than the sniffer probe clogged point.

Switching off the leak detector

The leak detector can be switched off at any time by depressing the main power switch to 0 (OFF)

ASM 102 S: Wait 2 minutes before moving the leak detector after its stop.

Operation of the leak detector

Some difficulties with the control panel use/access ?			
Operating principle of the control panel	110	Access to level 4 - Password	130
Setting and maintenance part presentation of the control panel	120	Summary of screens	140
Access to parameters and parameters active depending on authorization		Complete displays list with access way and associated sheet	

How to use your leak detector?

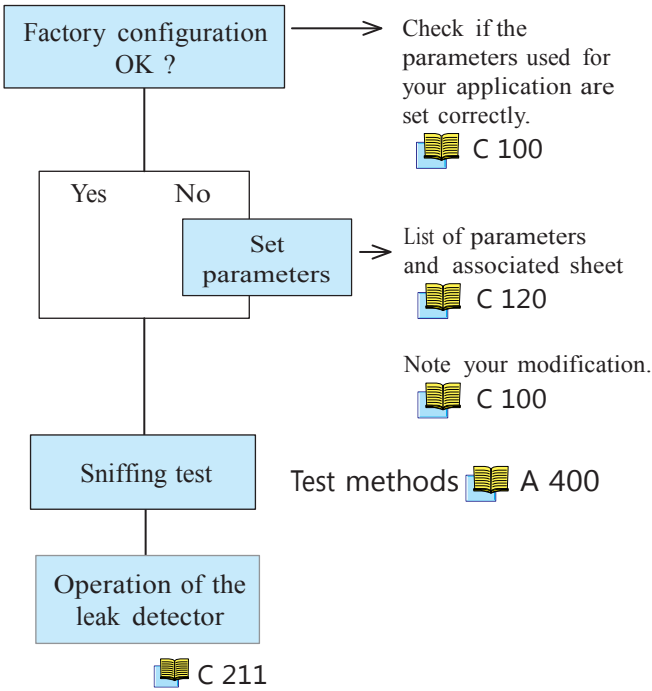

3 detector states

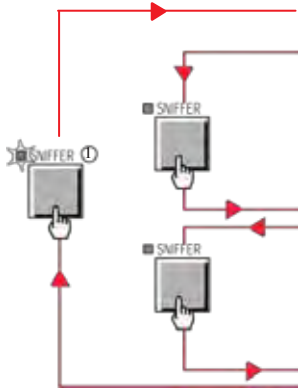

State	Description	LCD screen	Indicator light
Stand by	The detector is in stand by. It doesn't pump surrounding air.	STAND-BY Press «SMIFFER» key <i>Le message clignote</i>	
Preparation	The detector prepares to test.	SMIFFING MODE PLEASE WAIT ...	
Sniffing	The detector is ready to test.	SMIFFING MODE	

Ⓞ ASM 142 S only
The detector could put back itself in automatic stand by mode as soon as the «automatic stand by» period of time is reached (with the probe in the detector calibration part).

Operation of the leak detector

Sniffing test

Starting a sniffing test

While the leak detector is in standby mode, connect the sniffer probe (accessory to be purchased separately  A 700) to the sniffer port of the leak detector.

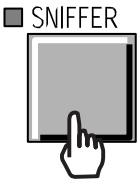
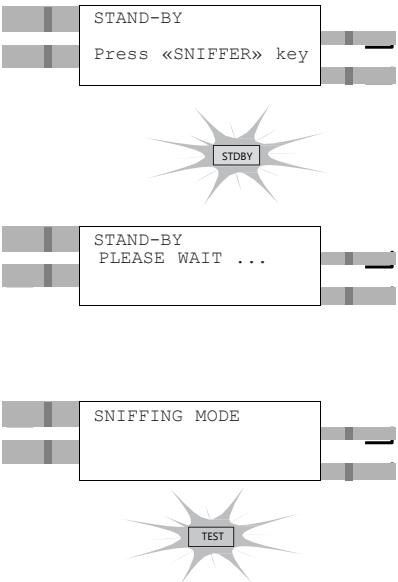

The sniffing mode message appears on the alphanumeric display.
The sniffing test mode is operational.

Detector in automatic standby mode

If the detector puts itself in standby mode automatically, it's necessary to put it back in sniffing mode:
- either remove the probe if it is in the leak detector calibration port.
- or press  key.



Ending a sniffing test

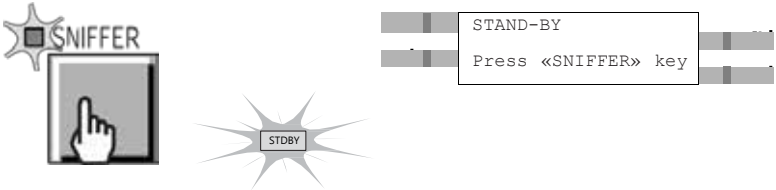

Display  C 213

Reject Threshold Adjustment

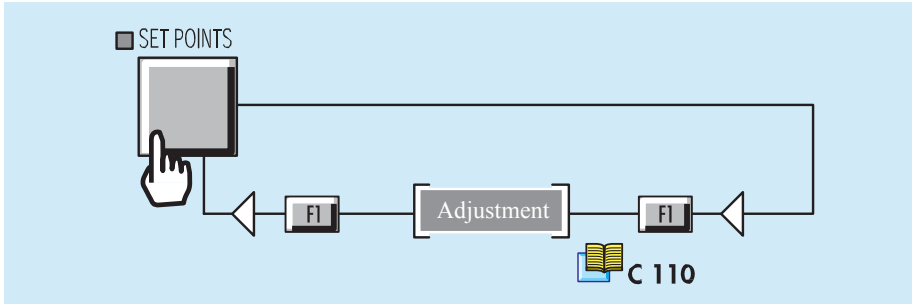

Unit change  C 570

Operation of the leak detector

Sniffer probe Accessories  A 700

The sniffer probe should be connected to the detector in stand by mode.

In order to materialize the use of a probe with a non standard length (standard probe = 5 m/49 ft), this length is displayed on the LCD display when you connect the probe to the detector.

Auto-standby (ASM 142 S only) To avoid that the probe is clogged too quickly, it is possible to stop the pumping in the probe.

Principle

Put the probe in the calibration port.

After a while of not withdrawal of the port, the probe stops pumping.

The detector goes in standby automatically.

From the probe withdrawal, detector in standby automatic, the probe is reactivated: the detector goes in sniffing.

Timer adjustment

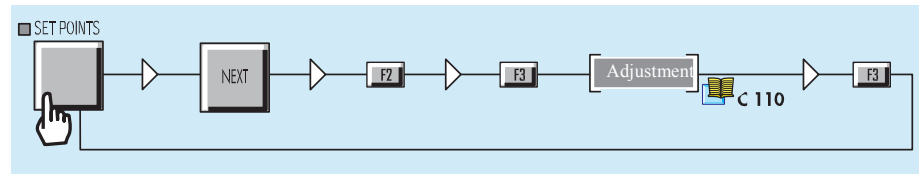

Response time adjustment The response time will depend on the probe length. You should to set it. 3 lengths are proposed: «=5» («=49»), «<15» («<49») and «>15» («>49»). For the «>15» length, it's necessary to set the response time.

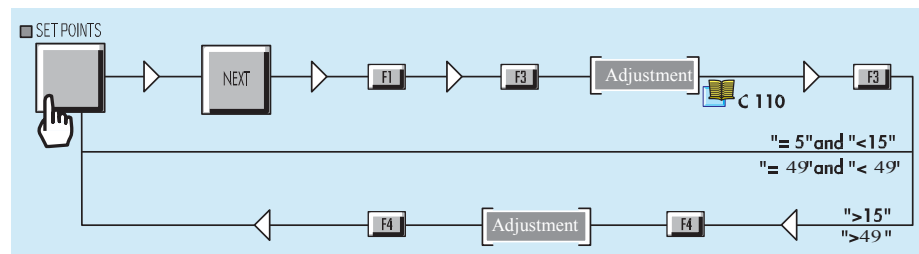

Operation of the leak detector

Sniffer probe clogged reject
point adjustment

When the Helium signal is lower than the «Sniffer probe clogged»
threshold set, an error message will be activated.

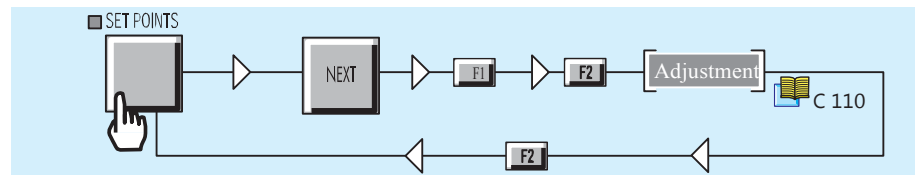

Unit change  C 570

Display



To avoid any confusion between the tracer gas and the filling gas, the tracer gas is permanently displayed on the LCD screen in sniffing mode.

Example :

tracer gas

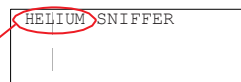

Analogic display You have the possibility to work with 2 display types:

- 10 decades display
- 2 decades display.

	10 decades display	2 decades display
Generalities	<ul style="list-style-type: none"> • The 10 decades display use is indicated by a specific led, except if a non basic unit is used. Units C 570 • The flashing led indicates the reject threshold (C 211). It could be affected or not to the reject threshold. • If a correction factor «COR» is applied, the bargraph scale is not correct any more: the bargraph allows a visual location compared to the reject threshold but not the leak value reading. 	<ul style="list-style-type: none"> • The 2 decades display use is indicated by 2 specific leds. • The flashing led indicates the reject threshold (C 211). It could be displayed or not. • The display is centered on the reject threshold (absolute value set in the working unit).
Reading	<p>The helium signal scale displays the value in 2 colors following the measured leak value:</p> <ul style="list-style-type: none"> • the reject point is display with a green led (according to setting). • if the measured leak value exceeds the reject point, the flashed leds are red (and the blinking led orange). The part is bad. • if the measured leak value is under the reject point, the flashed leds are green. The part is good. 	<p>The helium signal scale displays the value in 2 colors following the measured leak value:</p> <ul style="list-style-type: none"> • the reject point is display with a green led centered on 2 decades. • if the measured leak value exceeds the reject point, the flashed leds are red (and the blinking led orange). The part is bad. • if the measured leak value is under the reject point, the flashed leds are green. The part is good.

Display

Analogic display (continuation)

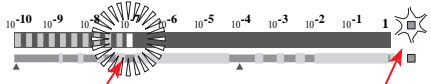
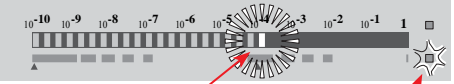
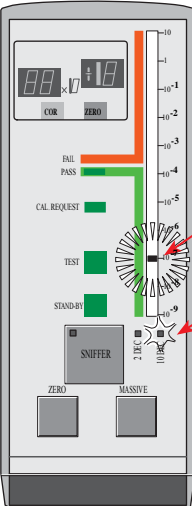
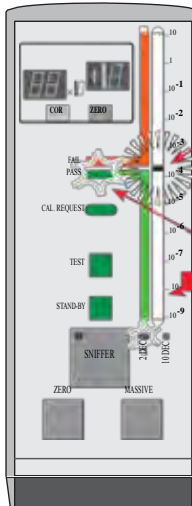
	10 decades display	2 decades display
Control panel Example : reject threshold = $1 \cdot 10^{-7}$ mbar.l/s	 <p>Reject threshold</p> <p>10 decades indicator light</p>	 <p>Reject threshold centered on 2 decades</p> <p>2 decades indicator light</p>
Remote control Example : reject threshold = $1 \cdot 10^{-7}$ mbar.l/s	 <p>Reject threshold</p> <p>10 decades indicator light</p>	 <p>Reject threshold centered on 2 decades</p> <p>2 decades indicator lights</p>

Display

Digital display

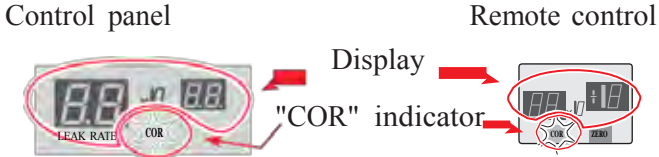

- The digital display allows to display different parameters: the leak value measured, the reject threshold set or nothing.
- In order to better identify the «sniffing» mode (C 211), it is possible nothing to display in the other modes.

Displayed parameter selection

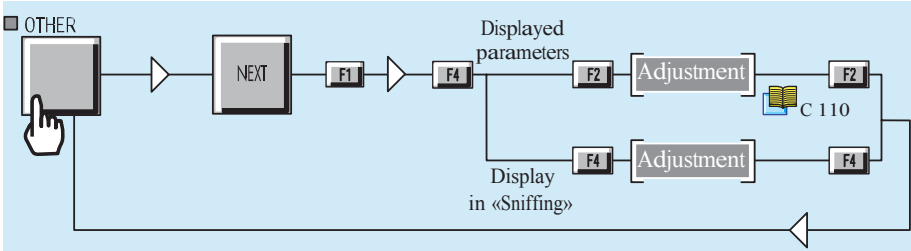

Flashing light and display selection

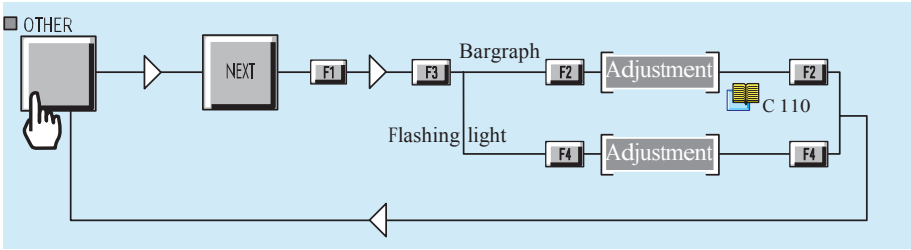

Nota : The flashing light allocation to the target value in autocalibration is always active: the light is red.

Display

Displays setting

The 4 adjustable parameters of the digital and analogic displays are grouped together in a structure in order to create 2 use configurations. These 2 configurations, and the values of the 4 parameters, are the following:

		Configuration	
		Standard	Production Pass/fail (*)
Analogic display	Bargraph	10	2
	Flashing led	yes	no
Digital display	Parameter displayed	Leak value	Reject threshold
	Display outside «sniffing»	no	no

(*) Production: ASM 142 S - Pass/fail: ASM 102 S
 Advised configuration for repetitive test.

It is possible to adapt these configurations to the user specificities: each parameter could be changed.

Configuration selection

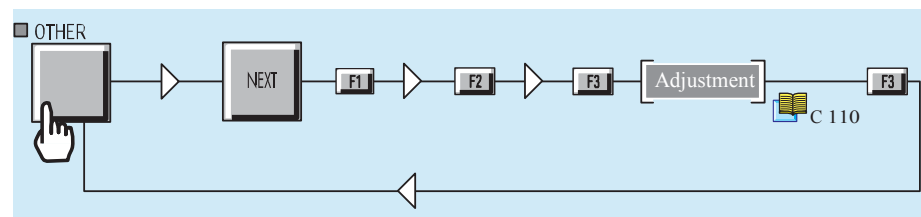

Come back to a preset configuration

In a configuration, it is always possible to change one of the parameters according to our needs. It is after possible to come back to the preset configuration as described previously if necessary.

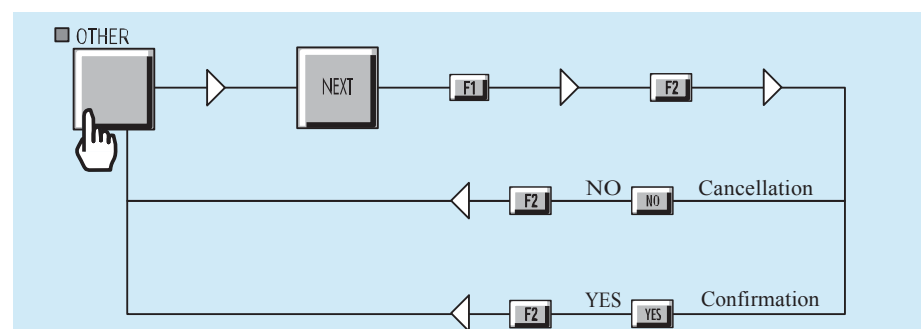

Calibration of the leak detector

Calibration of the leak detector



C 301

Calibrated leak values programming



C 305

Adaptator for calibrated leak



C 306

Calibration of the leak detector

Purpose of the calibration

Check that the leak detector is correctly adjusted to detect the tracer gas used and to display a correct leak value.
 To calibrate the leak detector, a calibrated leak is used as a reference.
 Note: The ASM 142 S could be equipped in option with an internal calibrated leak.

The calibration is semi-automatic if the operator uses an external calibrated leak. Otherwise, it is fully automatic.

Different types of calibration

To calibrate the leak detector according to the tracer gas, 3 sources can be used. According to this source, 3 calibration modes are proposed.

Source	Mode de calibration	Mesure
Calibrated leaks	Calibrated leaks	Quantitative measure of flow
Gaseous mixture	Concentration	Quantitative measure of concentration
Background <small>(ex : the background of the surrounding air)</small>	Peak only	Qualitative measure only

Note: ASM 142 S only

- The internal calibrated leak (option) is reserved for He.

When should calibration be performed?

- For high sensitivity test and optimized measurement accuracy: it is advised to let the internal temperature of the leak detector stabilize for about 30 min after start-up and then start a calibration.
- If in doubt regarding the proper operation of the leak detector (capability to properly detect the tracer gas). At any time, a calibration may be started after start up.
- In case of intensive and continuous use: start a calibration at the beginning of each shift (8 hours of operation).
- In case of tracer gas change for the 3 masses option.

Calibration of the leak detector

Internal calibrated leak

ASM 142 S only (option)



The internal calibrated leak is specifically designed to fit the present leak detector. It is composed of:

- a helium reservoir,
- a temperature sensor (used to take into account the effect of temperature on the leak rate),
- a built in membrane (to calibrate the helium leak rate),
- a special quick connection device,
- an identification label (similar to the identification label of an external calibrated leak).

It is delivered with a calibration certificate

Calibrated leak location  F 700

Recalibration

• It is recommended to have each calibrated leak recalibrated at regular intervals to validate its value

- A calibration date supervision is proposed. ( D 210)

Accessories  A 700

Calibration procedure

According to the source used, the calibration process is different.

Take care of the source used unit.  C 570

- Note:
- During a calibration, the bargraph leds are in orange on the control panel and the remote control. The «COR» indicator lights off during the calibration.
 - If the display is set on «2 decades», it will switch on «10 decades» during the calibration and come back to «2 decades» after.

Preliminary conditions

• The operator should select the source used for the calibration, if necessary.

- The operator could start a calibration by pressing  key provided that it is not locked by the setting.

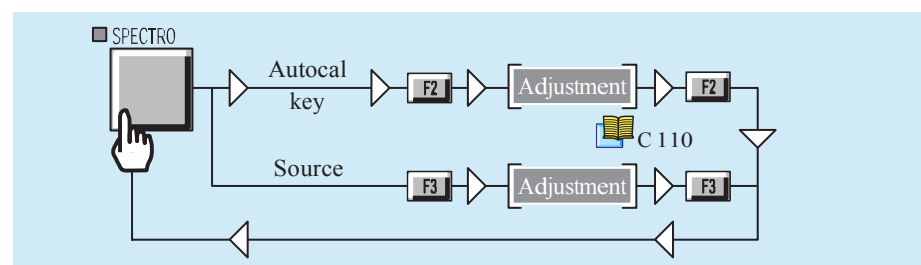

Calibration of the leak detector

Calibration reminder

In order to recall you to do a calibration regularly, you can set a counter which will launch a recall message on the LCD screen in order to do a new calibration.

Counter setting:

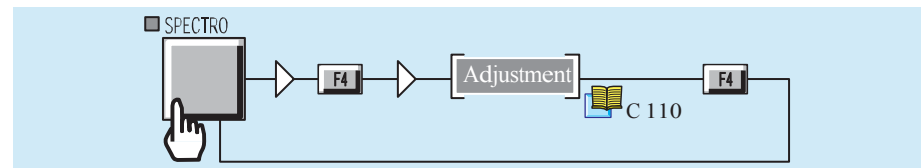

Calibration with an internal calibrated leak (ASM 142 S only)

No operator operation is necessary during the calibration.

- Correct the internal calibrated leak value set after each recalibration.



- Detector in sniffing mode

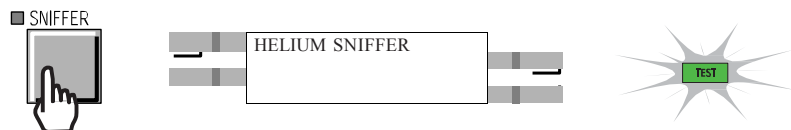

- The operator inserts the sniffer probe in the detector calibration port.

- Start a calibration.

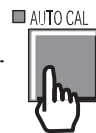

- Different screens appear during the calibration and inform the operator about the process. The detector try to adjust the calibration: if the adjustment is out tolerance ($\pm 15\%$), a complete recalibration is done.

- When the calibration is finished, the detector is ready to test. The digital voice informs the operator: «detector ready».

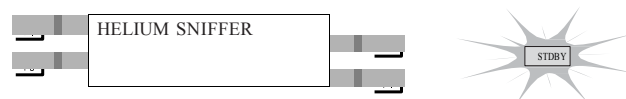

- Note:
- It is possible to do a test after a calibration failure. In this case, an error message informs the operator that the detector is not calibrated («AL» displayed permanently).

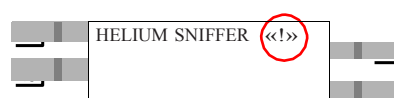

- If a printer is connected, a calibration ticket is automatically printed at the end of the calibration:

example : 2a B 320

Calibration of the leak detector

Calibration with an external calibrated leak

Several operator operations are necessary during the calibration process.

- Detector in sniffing mode.

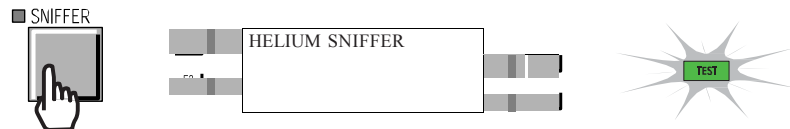

- If the 3 masses option is selected, choice the tracer gas used.

C 430

- The selected source should be the external calibrated leak.

- Correct the external calibrated leak values set. C 305

- If the external calibrated leak is equipped with a valve, open it.

- Start a calibration.



- Insert the sniffer probe as requested: adjust the calibrated leak temperature for a corrected leak.

C 305

- Not corrected leak:

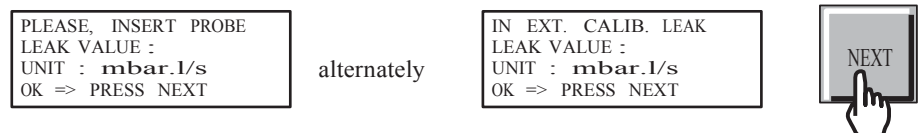

- Corrected leak:

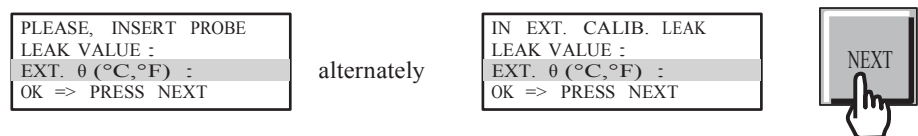

- Different screens appear during the calibration and inform the operator about the process.

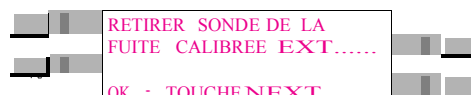

- If the external calibrated leak is equipped with a valve, close it.
- Remove the sniffer probe as requested.



Calibration of the leak detector

- When the calibration is finished, the detector is ready to test. The digital voice informs the operator: «detector ready».

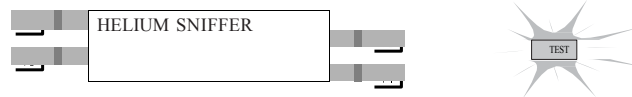

- Note:
- It is possible to do a test after a calibration failure. In this case, an error message informs the operator that the detector is not calibrated («AL» displayed permanently).

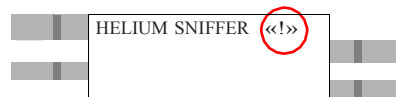

- If a printer is connected, a calibration ticket is automatically printed at the end of the calibration:

example : 2b B 320

Calibration on concentration

Several operator operations are necessary during the calibration process.

- Detector in sniffing mode:

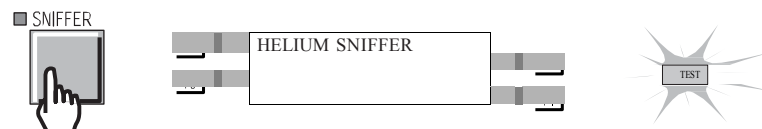

- The selected source should be the concentration.
- Correct the concentration values set:

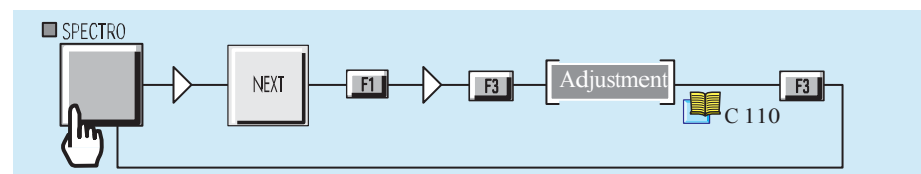

- If the volume with the gas concentration is equipped with a valve, open it.

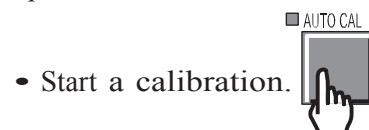

- Start a calibration.
- Insert the sniffer probe as requested.

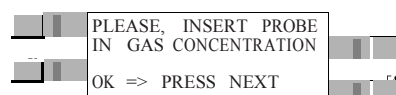

Calibration of the leak detector

- Different screens appear during the calibration and inform the operator about the process. The detector try to adjust the calibration: if the adjustment is out tolerance ($\pm 15\%$), a complete recalibration is done.



- If the volume with the gas concentration is equipped with a valve, close it.

- When the calibration is finished, the detector is ready to test. The digital voice informs the operator: «detector ready».

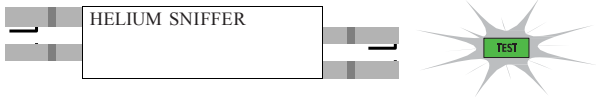

Note: • It is possible to do a test after a calibration failure. In this case, an error message informs the operator that the detector is not calibrated («AL» displayed permanently).

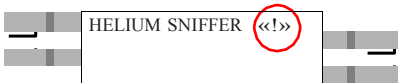

- If a printer is connected, a calibration ticket is automatically printed at the end of the calibration:

example : 2c  B 320

Units: If the concentration is selected as calibration source, the set units are changed:

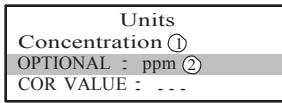
-  Basic units indicator suppression.
-  - «concentration» appears at the place of the basic unit ①.
- the operator should set an optional unit: ppm or special are only available ②.

 C 570

Calibration on background No operator operations is necessary during the calibration process.

- Detector in sniffing mode.

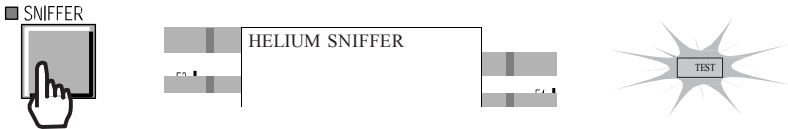

Calibration of the leak detector

- The selected source should be «background». As soon as the gas selection, the signal digital display disappears to materialize the measure impossibility.

- Insert the sniffer probe in the place choiced by the operator.

- Start a calibration. 

- Different screens appear during the calibration.

- When the calibration is finished, the detector is ready to test. The digital voice informs the operator: «detector ready».

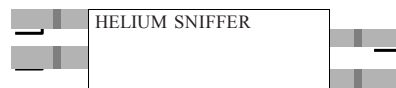

Note: It is possible to do a test after a calibration failure. In this case, an error message informs the operator that the detector is not calibrated («AL» displayed permanently).

Detector calibration frequency

When the period of time set on the «period» counter is reached, a warning «autocal required» is set on the display panel (LCD) and digital voice.



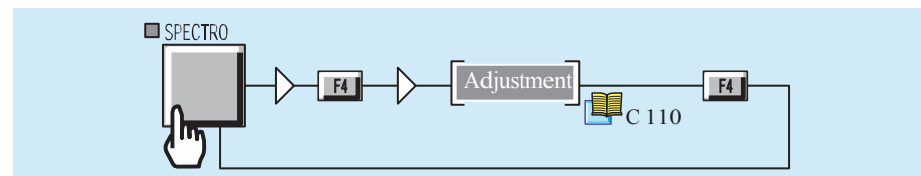

The led «cal. request» is activated on the remote control.

ASM 142 S with internal leak option only: if the source is the internal leak and if the sniffer probe is inserted in the detector calibration port, the calibration will start immediately.

Detector calibration period adjustment:



Calibrated leak values programming

Some difficulties with the control panel use/access ?	
Operating principle of the control panel Présentation de la partie réglage et maintenance du panneau de contrôle Accès aux paramètres et aux paramètres actifs suivant les autorisations	 110  120
Access to level  - Password Summary of screens Complete displays list with access way and associated sheet	 130  140

Different types of calibrated leaks

Before to start a calibration of the leak detector, with an internal calibrated leak (ASM 142 S only with the internal leak option), the parameters of the calibrated leak used should be programmed by the operator. These parameters allow to correct automatically the leak value.

For a calibration with an external calibrated leak, these same parameters could also be programmed in order to correct it. It is also possible to use an external calibrated leak without correction of its value.

The leak detector can be calibrated:

- with a helium calibrated leak
- with different gases (Hydrogen and Helium 3) if it is equipped with the 3 masses option. The detector should be calibrated with a leak of the researched gas. The parameters of the 3 possible leaks (He, He3 and H) are memorized when we change of gas.

3 masses option  C 430

Gas	Internal leak calibration (ASM 142 S only - option)	External leak calibration
Helium	X	X
Helium 3	-	X
Hydrogen	-	X

Whatever the type of calibrated leak used, the parameters to program are the same.

Calibrated leak values programming

Programming the calibrated leak parameters

This operation can be made with the data written on the calibrated leak identification label or the calibration certificate delivered with it. Example of identification label:

HELIUM CALIBRATED LEAK
 Helium leak rate : 1.0×10^{-8} mbar.l/s at 20 °C
 Date of calibration : 10 Dec 2001
 % loss per year : 2 %
 % increase per °C : 3 %

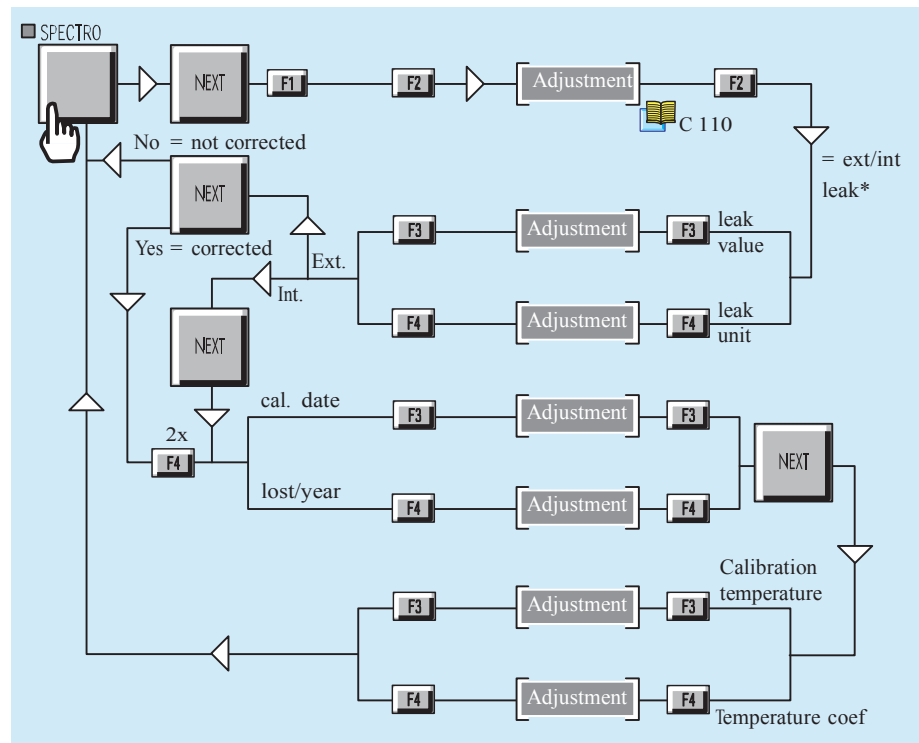

(*) internal : only ASM 142 S (option)

Calibrated leak supervision

A recalibration date supervision is programmed.

This supervision allows to follow the calibrated leak recalibration date selected as current source.

Supervision  D 210

Adaptator for calibrated leak

An adaptator DN 16 or DN 25 for calibrated leak has been designed for the calibration of the detector with an external calibrated leak.

Accessories  A 700



How to use the adaptator ?

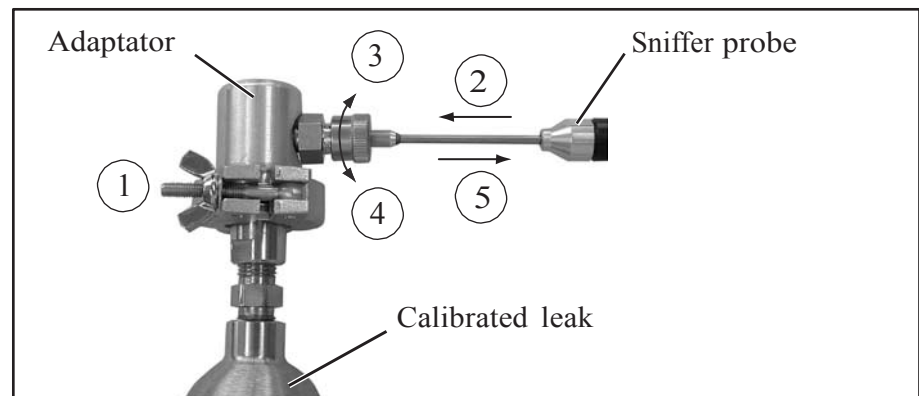

- ① Place the adaptator to your calibrated leak used for the calibration.

Start a calibration

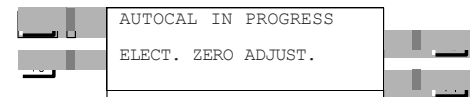

- ② Place the sniffer probe in the calibration port.

- ③ Tighten the fixing screw. Follow the auto-calibration.

Calibration of the leak detector  C 300

- ④ Untighten the fixing screw.

- ⑤ Remove the sniffer probe of the calibration port. Follow the auto-calibration.

Notes - Waiting 10 s (mini) for the signal stabilization before reading of the leak value.

- The leak value displayed on the LCD consider the He of the air.

Example : calibration with a leak of 2×10^{-5} mbar.l/s

The value displayed is:

$$2 \times 10^{-5} + 5 \times 10^{-6} = 2,5 \times 10^{-5} \text{ mbar.l/s}$$

Remote control



Remote control interface

The remote control is an accessory.

The remote control is equipped with a magnet allowing the operator to place it on a metallic surface. The operator can read the helium signal and has access to control keys such as test command zero function and mesurer function.

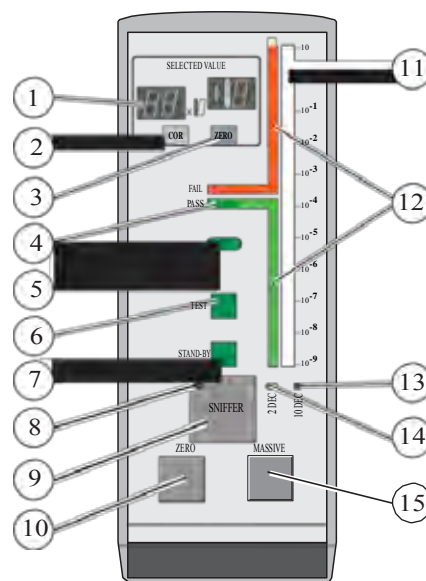

1	Helium Signal digital display
2	Correction factor COR indicator
3	Zero function indicator
4	2 decades scale indicator
5	Request calibration indicator
6	Test indicator
7	Standby detector indicator
8	Test indicator (ON when activated)
9	Test control key
10	Zero function control key
11	Tracer gas analogic display
12	Silkscreen print associated to the «pass» light for aproduction use (green below the threshold, red above)
13	10 decades scale use indicator
14	2 decades scale use indicator
15	ON/OFF massive function control key

Remote control

Remote control connecting



Location and connecting  B 210

Units The remote control displays the value in the unit selected in the leak detector.

Users levels

All the keys of the remote control are available as soon as the user level set in the detector is ≥ 1 .

 C 310 and C 120

In this cases  ,  and  keys are available as soon as a menu is in progress (password activated).

Use and display

The remote control:

- allows to display leak measured value or the reject point,
- allows to go in sniffing mode, to start zero and massive functions,
- allows to indicate detector state and a calibration need,
- doesn't allow to adjust leak detector parameters.

Analog and digital displays

On remote control and control panel, the displayed values on the analog and digital displays are exactly the same.

Operation of the leak detector  C 211

Detector standby/test

Put the detector in standby/TEST. By default, the detector is in test mode. The operator can put it in standby mode (any pumping by the probe, any electric emission) to reduce the service interventions. If you press the «SNIFFER» key when the detector is in test mode, you deactivate the TEST led.



To go back in test mode, press again on «SNIFFER» key.

Remote control

Use and display (ctd)

Zero function



In order to start zero function, operator can use either the ZERO control key on the control panel or remote control.

Display

The zero indicator is ON when the function is activated.



Zero function  C 540

Massive function

This function is only accessible by the remote control: long press on the MASSIVE touch.

Display

The green led becomes red (or orange), when the function is activated.



Massive function  C 630

Headphone and loudspeaker

The operator can connect a headphone or an external loudspeaker to the detector.

The detector must be equipped with the RS 232 option

Connecting  B 210

Level adjustment

The audio levels for the headphone or the external loudspeaker are the same as for the audio alarm and digital voice functions. In order to adjust the headphone or the external loudspeaker audio levels, you must adjust the levels of the audio alarm and digital voice functions.

Audio alarm / Digital voice  C 520

Accessories ?

Headphone You should use the headphone connector accessory:

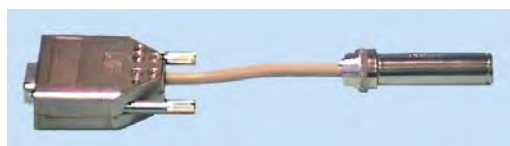

Sub D 9 pins

Jack plug 6.35 mm mono

Accessories  A 700

Alcatel does not sell headphones. The specifications are:

- Impedance: 400/500 Ω
- Jack plug 6.35 mm (or other sizes with adaptator)
- Frequency band: 18 kHz to 20 kHz

External loudspeaker

Alcatel does not sell external loudspeaker. The specifications are:
The external loudspeaker has the same characteristics as the internal loudspeaker:

- Impedance: 8 Ω
- Power: 8 W

Headphone and loudspeaker

Configuration The operator can deactivate or not the internal loudspeaker when he uses a headphone.
In the same way, he can deactivate or not the internal loudspeaker when he uses an external loudspeaker.
The functions are selected on the I/O interface board.

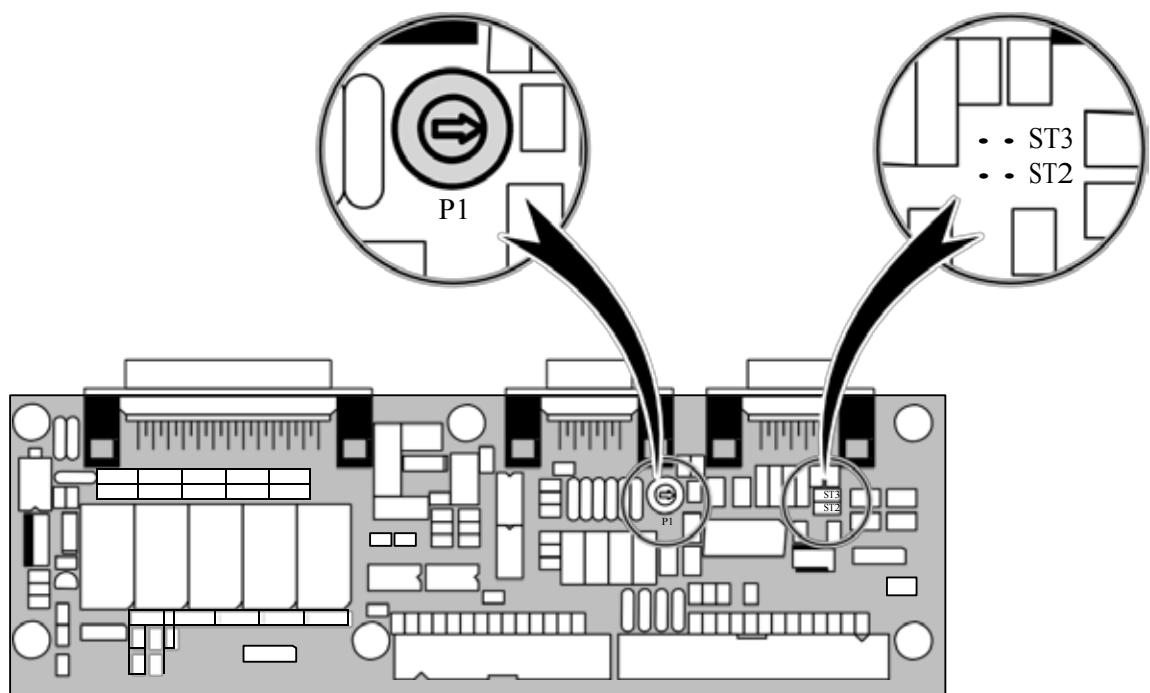









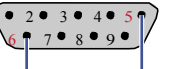

P0307 board

P0307 board localisation  F 400

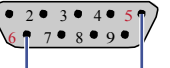
- The operator can adjust the headphone audio level with P1 or with panel control (⊕ and ⊖).

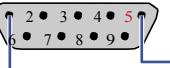
Headphone and loudspeaker

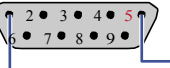
	P0344 card	Strap on ST3/ST2	Sub D 9 pins (printer plug)
Int 	Internal loudspeaker active	<ul style="list-style-type: none"> • ST3 • ST2 	No plug connected
		<ul style="list-style-type: none"> • ST3 • ST2 	
Int  	Internal loudspeaker active + headphone connected	<ul style="list-style-type: none"> • ST3 • ST2 	
Int  	Internal loudspeaker not active + headphone connected	<ul style="list-style-type: none"> • ST3 • ST2 	
Int  Ext 	Internal loudspeaker active + External loudspeaker connected	<ul style="list-style-type: none"> • ST3 • ST2 	
Int  Ext 	Internal loudspeaker not active + External loudspeaker connected	<ul style="list-style-type: none"> • ST3 • ST2 	

3 masses option

Purpose Leak detection is used to detect micro-openings, porosities, etc. in test parts. The detection of these passages involves the use of a light gas, which is capable of infiltrating the smallest passages quickly. The standard gas used is the Helium 4 but the operator has the possibility with the 3 masses option to use another gases: Hydrogen or Helium 3.

Background is much higher in H₂.

The unit equipped with the 3 masses option does not have any external differences in relation to the standard unit. The modifications are inside the unit (analysis cell magnet and electronic supervisor board).

The tracer gas selected is displayed on the control panel LCD screen:

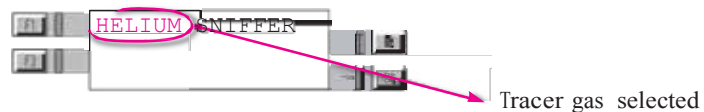

The 3 masses option purpose, used with Hydrogen, is the leak research only and not the continuous analysis of the hydrogen concentration of a gas.

The leak detector is not adapted for a hydrogen concentration continuous analysis. The leak detector use in such conditions, as well as the hydrogen concentration of the gas used, are under the supervision of the user.

The functions are the same as the standard detector.

Gas selection

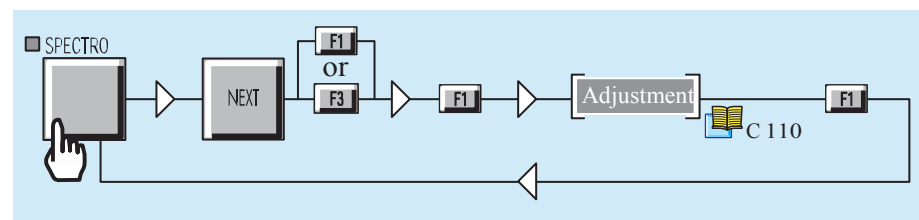

3 masses option

Calibration in Hydrogen or Helium 3 The leak detector can be calibrated in Hydrogen or Helium 3 with an external calibrated leak.

Procedure The operator should adjust the parameters of the calibrated leak used before a calibration.

Calibrated leak values programming  C 305

Calibration of the leak detector  C 300

Long distance sniffer probe and Helium spray gun

Please refer to the specific sheets for the instruction:

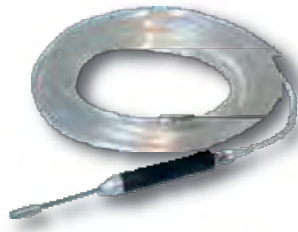

Long distance sniffer probe
 G 400 / G 410



Helium spray gun  G 500

Audio alarm / Digital voice

Some difficulties with the control panel use/access ?	
Operating principle of the control panel	110
Setting and maintenance part presentation of the control panel	120
Access to parameters and parameters active depending on authorization	
Access to level 4 - Password	130
Summary of screens	140
Complete displays list with access way and associated sheet	

Audio alarm definition The Audio alarm appears differently, based on the Zero function.

- Zero function is not activated:
The standard Audio alarm is started when the helium signal is exceeding a set point and called reject point.
- Zero function is activated and 10 decades analogic display: «Bip» are emitted permanently with a more and more fast rythm according to the number of leds on. They are stopped and replaced by the standard audio alarm as soon as the signal is above of the reject set point.

Zero function  C 540

Digital voice definition The digital voice informs the operator by sending audio messages in the following cases:

- starting-up process and auto-calibration process
- when detector is ready
- fault or warning.

General

At any time it is possible to adjust the volume if any menu is activated:
to increase volume to decrease volume



Sound level The level varies from 0 to 9 (= 90 dBA).

Adjustment

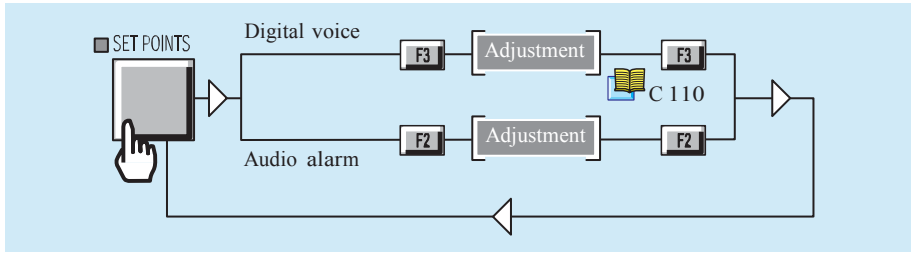

Zero function

Some difficulties with the control panel use/access ?

Operating principle of the control panel



C 110

Setting and maintenance part presentation of the control panel
Access to parameters and parameters active
depending on authorization



C 120

Access to level 4 - Password



C 130

Summary of screens
Complete displays list with access
way and associated sheet



C 140

Purpose Zero function is provided:

- to help the operator to identify a very small fluctuation of the helium signal out of the ambient background,
- to enlarge small fluctuations of the helium signal on the analog display.

The zero function allows the operator to work with a reject point below to the background.

The zero function could be activated:

- by the operator,
- in automatic.

It's advised to use this function when helium background signal is not instable other wise, the instabilities will be amplified.

Procedure The process of the zero function is the same whatever the activation mode (operator or automatic).

In automatic mode, the zero function captures automatically the residual in TEST, according to a defined rythm (see setting below).

Note: The zero key is no more active and the capture is materialized by the 2 decades led flashing.

Principle

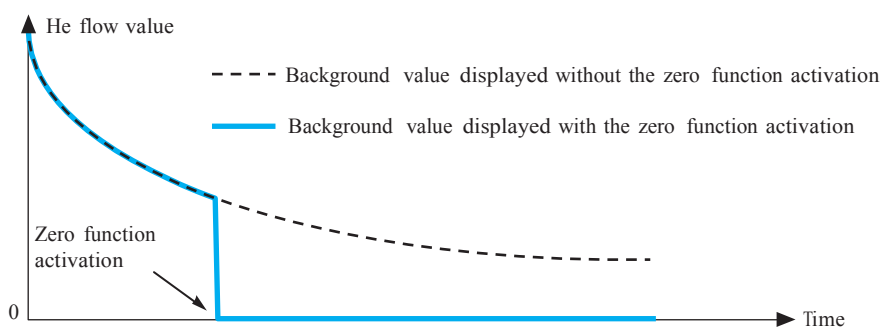

Zero function

Activate/desactivate the zero function manually



Zero function setting

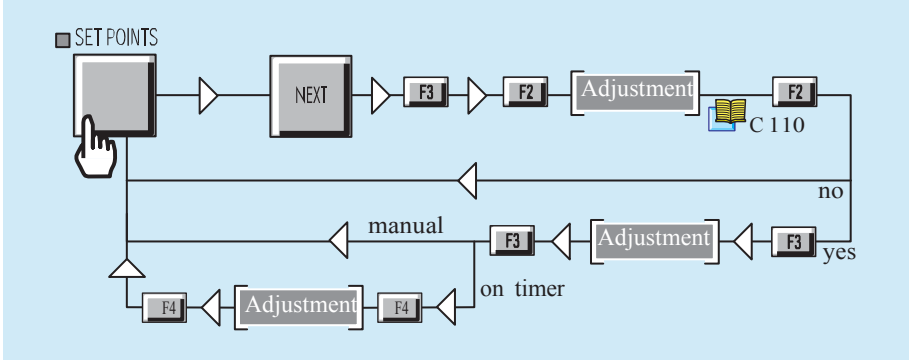

The period of time corresponds to the period of time between each capture (zero up dating).

Note : In automatic, the press on the  key starts a new capture.

Audio level

 C 520

Zero function

Display

10 decades display

- Analogic display:
When the zero function is activated, the 10 decades led is off. 2 leds on the bargraph are always off. A signal increase equal to the background value will induce the bargraph filling.

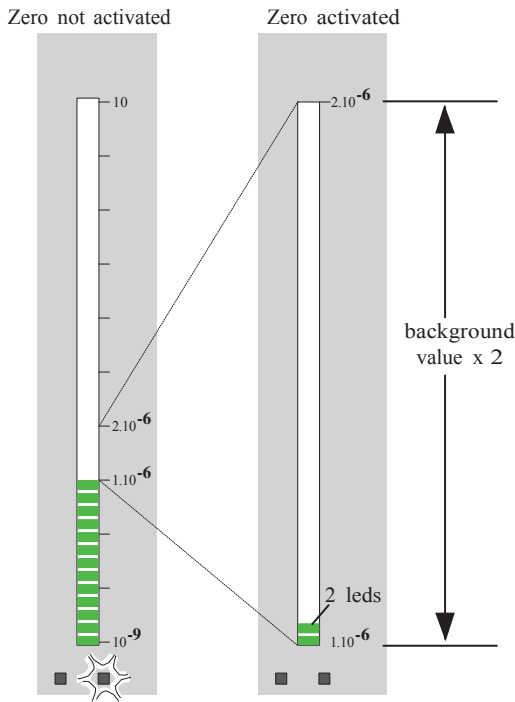

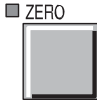
- Digital display :
The display value is the real signal value, reduced by the captured value when you pressed the  key.

Note: All coefficients remain applied to the signal.

Example: Background = 1.10^{-6} mbar.l/s

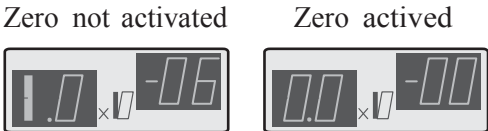

Zero function

2 decades display

- Analogic display:
When the zero function is activated, only the number of displayed leds could decrease according to the background value compared to the reject threshold.

Example: Background = $5 \cdot 10^{-6}$ mbar l/s cases ① and ②

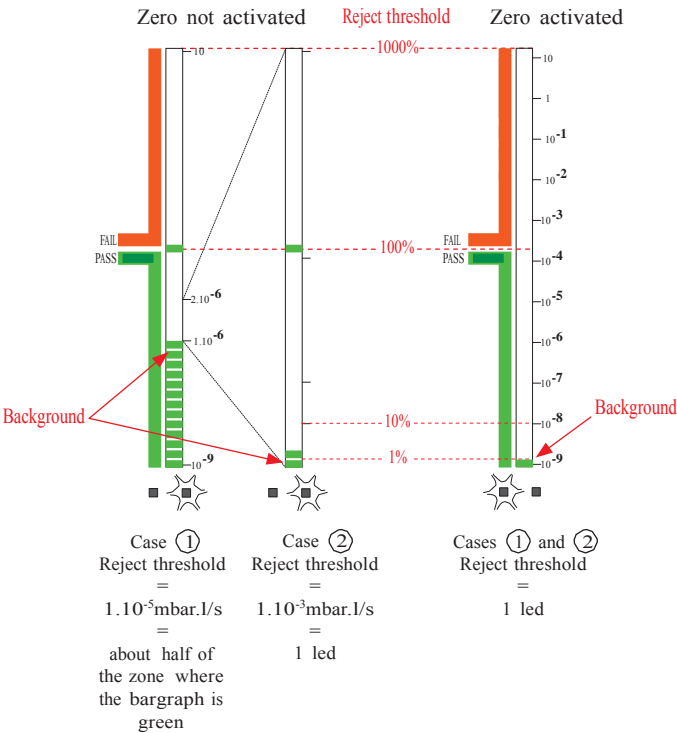

- Digital display:
The value displayed corresponds to 1 % of the reject point parametered, with a limit of $1 \cdot 10^{-7}$ mbar.l/s.

Example : background = $5 \cdot 10^{-6}$ mbar.l/s

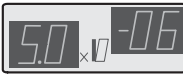
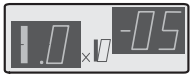
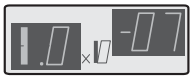
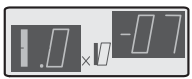
	Zero not activated	Zero activated	
Reject point = $1 \cdot 10^{-3}$ mbar.l/s	 = Detector background		= 1 % of the reject point
Reject point = $1 \cdot 10^{-5}$ mbar.l/s			
Reject point = $1 \cdot 10^{-6}$ mbar.l/s			= 1 % limited to $1 \cdot 10^{-7}$ mbar.l/s

Date - Time - Language - Unit

Some difficulties with the control panel use/access ?	
Operating principle of the control panel	110
Setting and maintenance part presentation of the control panel	120
Access to parameters and parameters active depending on authorization	130
Access to level 4 - Password	130
Summary of screens	140
Complete displays list with access way and associated sheet	140

Adjustment procedure

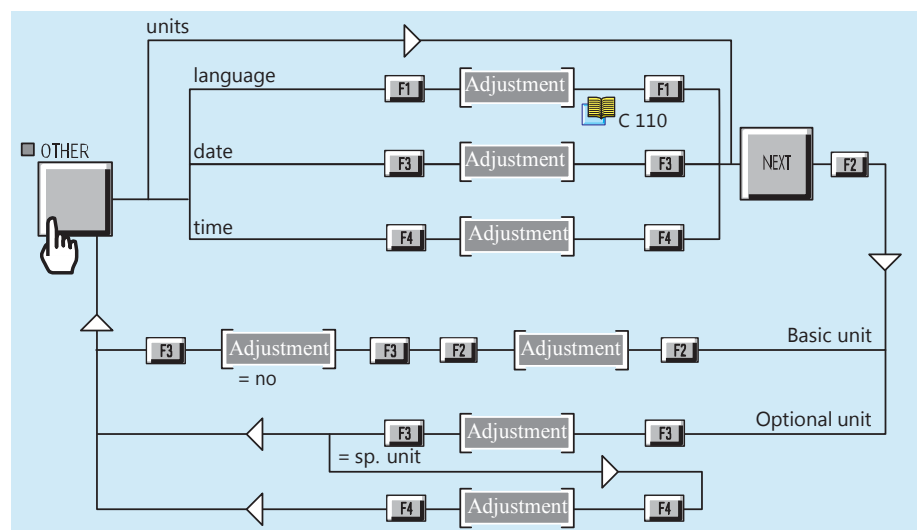

Date The leak detector calculates its storage period since the last switching off C 200

Take care to set the correct date.

Language The leak detector offers 2,3 or 4 languages, according to the model.

A 600

Notes:

- All messages on the LCD are on the selected language.
- The selected language is the language of the digital voice.

Digital voice C 520

Date - Time - Language - Unit

Units The leak detector proposes:

- basic units
- optional units.

- Basic units:

These units are used for the leak flow, and the calibrated leak flow:

- mbar.l/s
- Torr.l/s
- Pa.m³/s

In order to use the basic units, the optional unit must be set on «no». A light indicates the unit set:



The leak flow unit could be different of the calibrated leak flow unit.

Calibrated leak setting  C 305

When the operator connects a remote control on the leak detector, the remote control is automatically configured with the basic unit set on the detector.

In case of units change:

- the following parameters are automatically recalculated:
 - reject threshold,
 - probe clogged.
- the new values are displayed on the digital display.
- the leds (bargraph and flashing) position changes only with 10 decades display.

It's so necessary to change the unit before to change the reject threshold.

- Optional units:

These units are used for:

- the concentration: ppm
- the flow : gr/yr, oz/yr and lb/yr of the tracer gas used.

They will be used in priority on the basic units as soon as the optional unit value is other than «no».

Date - Time - Language - Unit

If an optional unit is selected, it is displayed permanently on the test screen.

Example:  A screenshot of a device screen. The top line displays 'RENIF HELIUM'. The bottom line displays '<COR> = ppm'. The screen is framed by a grey border.

If an optional unit was selected for a calibration source and you change of calibration source, this unit applies to the new selected source.

If you want to use another unit (optional or basic), it is also necessary to change the unit when you select the new source.

A user customization is also possible (sp. unit).

In the case of a customization, the user should set the correction value.

When the «COR» indicator is on, the unit used is displayed on the LCD screen.

Example:  A screenshot of a device screen. The left side shows two digital displays with '88' and '88' and a 'COR' indicator. Below them are labels 'LEAK RATE' and 'COR'. To the right is a menu with 'HELIUM SNIF. ON' and '<COR> = gr/y'. Below the menu are three unit options: 'mbar.l/s', 'Pa.m³/s', and 'Torr.l/s'. A 'F4' key is visible at the bottom right.

Note: If the concentration is selected as a calibration source, the units set are changed: See  C 301.

Fault / information indicator and display

Fault and information

At any time, the leak detector can display on the LCD clear Information or Fault messages based on the analysis of the leak detector status.

There are 3 basic types of faults: minor fault, major fault and critical failure.

There are 2 basic types of information: user information and service information.

The messages are displayed on a specific display by order of importance:

1. critical failure
2. major fault and minor fault
3. user information and service information

Faults

Minor fault

3 fault types: minor fault, major fault and critical failure.

- Warning:

- on the digital display alternatively the helium signal and “Er” are shown.

- on the LCD, a “!” flashing at the right end of the 1st line.

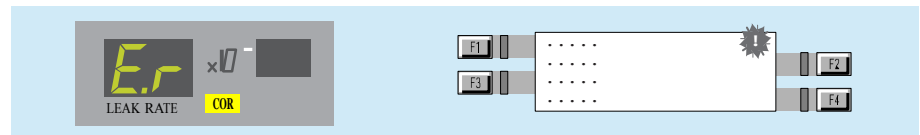

The digital voice advises the operator of the procedure to follow.

- Result:

This will not stop the functions of the leak detector but can affect the validity of the test result.

- Message:

To read the message



A clear message describes the error on line 2 and 3. The most important warning message is displayed on the 1st line.

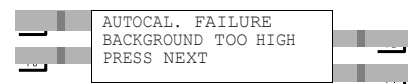

Up to 3 messages may be displayed on the message display.

- Duration: may be temporary or permanent

- temporary if the fault appears and then disappears without a corrective action from the user

- permanent until the cause is erased by the user.

- Remedy:

- Temporary: the indicator disappears and the warning message is erased.

- Permanent: both indicator and message are memorized until the fault is eliminated.

Fault / information indicator and display

Faults (cont.)

ASM 142 S and ASM 102 S special case:

- If after the start, the background is lower than the sniffer probe clogged point:
- The “AL” message appears permanently on the digital display,
- a «!» flashing at the right end of the screen.
- This default, although minor, is blocking. It is necessary to launch a calibration to make it disappear.



Major fault

- Warning:
- on the digital display, “Er” is permanently displayed.
- a flashing message occurs on the LCD

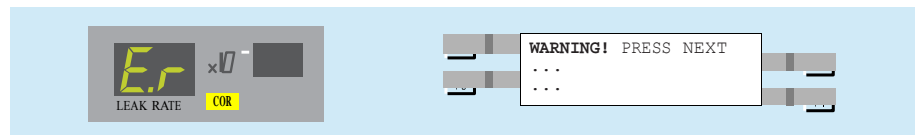

the digital voice advises the operator of the procedure to follow.

- Result:
- May prevent the leak detector from making a vacuum test or an autocalibration

- Message:

To read the message 

Note: A major fault can behave like a temporary minor fault if the origin of the error has disappeared.

Critical failure

- Warning:
- on the digital display, “Er” is permanently displayed. All indicators are turned off.
- on the LCD the clear message of a critical failure is directly displayed. Details are displayed on line 2 and 3.

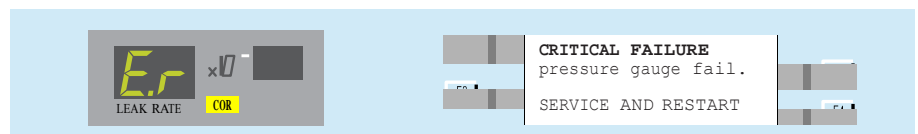

The digital voice advises the operator of the procedure to follow.

- Result:
- Complete shut down of the leak detector is required.
- Remedy:
- Need the servicing of the leak detector before starting it again.

Fault / information indicator and display

Information 2 information types: user and service information.

- Warning:
 - no indicator on the digital display
 - on the LCD, a “i” flashing at the right end of the 1st line.

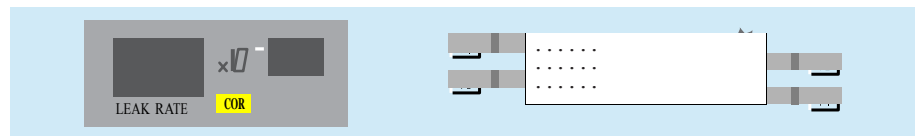

- The digital voice advises the operator of the procedure to follow.

- Result:

Doesn't affect the functions of the leak detector

- User information

Only an indication that the leak detector is in a particular status which may require an action from the user in order to return to a standard situation

- Service information

Only an indication that the leak detector requires a service or maintenance action.

- Message:

To read the message



A clear message describes the fault on line 2 and 3.

User information display

Service information display

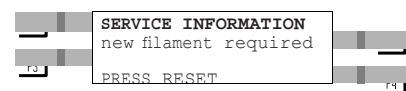
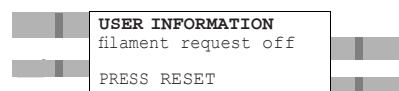

- Duration:

After display of the clear message, the indicator and the clear message are erased but they will be reactivated at the next start-up of the leak detector or at each unauthorized request by the user or 30 min later, if the origin of the message is still present.

- Remedy:

- User information

Can be eliminated by an action which is accessible by the user.

- Service information

Can be eliminated by a service action on the involved component and by resetting the corresponding configuration parameter. This is only accessible by the customer service.

Service instructions  E

Fault / information indicator and display

List of messages For all messages, note their contents in order to identify the origin of the message and take the corresponding corrective action if necessary.

General troubleshooting guide  D 300

The RS 232 codes of these messages are described in the specific RS 232 user manual.

	User Information	Service Information	ASM 182 T	ASM 192 T	ASM 192 T2	ASM 182 TD+	ASM 192 TD+	ASM 192 T2D+	ASM 122 D	ASM 142	ASM 142 D	ASM 142 S	ASM 1002	ASM 102 S
Information messages														
auto. cal. required	•		•	•	•	•	•	•	•	•	•	•	•	•
filament request off	•		•	•	•	•	•	•	•	•	•	•	•	•
manual calibration	•		•	•	•	•	•	•	•	•	•		•	
auto. cal. aborted	•		•	•	•	•	•	•	•	•	•	•	•	•
drift too high (zero)	•		•	•	•	•	•	•	•	•	•	•	•	•
He too high for zero	•		•	•	•	•	•	•	•	•	•	•	•	•
He too low for zero	•		•	•	•	•	•	•	•	•	•	•	•	•
external calib. Leak	•		•	•	•	•	•	•	•	•	•		•	
new fil#1 required		•	•	•	•	•	•	•	•	•	•	•	•	•
new fil#2 required		•	•	•	•	•	•	•	•	•	•	•	•	•
maintenance required		•	•	•	•	•	•	•	•	•	•	•	•	•
fil1-collector short		•	•	•	•	•	•	•	•	•	•		•	
fil2-collector short		•	•	•	•	•	•	•	•	•	•		•	
press zero & spray He	•		•	•	•	•	•	•	•	•	•		•	
no Hy leak for calib	•		•	•	•	•	•	•	•	•	•		•	
Bargraph 2 decades												•		•
Blinking led off												•		•
Use sniffer remote												•		•
ext. cal. recal.												•		•
int. cal. recal.												•		
primary pump maint.	•					•(4)	•(4)	•(4)	•(8)		•(10)			•(12)
Roughing pump maint.	•			•(2)	•(3)	•(3)	•(3)	•(2)	•(6)		•(5)			
high. vac pump maint	•	•(1)	•(1)	•(1)	•(1)	•(1)	•(1)	•(1)	•(7)	•(9)	•(9)	•(9)	•(11)	•(5)

- | | | |
|--------------|------------------|---------------------|
| (1) PTM 5154 | (5) MDP 5006 HDS | (9) AMP 007 I |
| (2) ATP 100 | (6) ATH 31+ | (10) AMD 1 |
| (3) MDP 5011 | (7) ATH 31 | (11) ATH 164 |
| (4) ACP 28 | (8) Dry pump | (12) Diaphragm pump |

Fault / information indicator and display

	Défauts mineurs	Défauts majeurs	Défauts critiques	ASM 182 T	ASM 192 T	ASM 192 T2	ASM 182 TD+	ASM 192 TD+	ASM 192 T2D+	ASM 122 D	ASM 142	ASM 142 D	ASM 142 S	ASM 1002	ASM 102 S
Error message															
autocal failure	•			•	•	•	•	•	•	•	•	•	•	•	•
temperature too low	•			•	•	•	•	•	•	•	•	•	•	•	•
temperature too high	•			•	•	•	•	•	•	•	•	•	•	•	•
cal. leak year error	•			•	•	•	•	•	•	•	•	•	•	•	•
peak search error	•			•	•	•	•	•	•	•	•	•	•	•	•
peak adjust error	•			•	•	•	•	•	•	•	•	•	•	•	•
background too high	•			•	•	•	•	•	•	•	•	•	•	•	•
emission loss	•			•	•	•	•	•	•	•	•	•	•	•	•
cell. zero off limits	•			•	•	•	•	•	•	•	•	•	•	•	•
cell. zero stability	•			•	•	•	•	•	•	•	•	•	•	•	•
calib. test mode lost	•			•	•	•	•	•	•	•	•	•	•	•	•
sensitivity too high	•			•	•	•	•	•	•	•	•	•	•	•	•
background trouble	•			•	•	•	•	•	•	•	•	•	•	•	•
lack of sensitivity	•			•	•	•	•	•	•	•	•	•	•	•	•
cell.pressure safety		•		•	•	•	•	•	•	•	•	•	•	•	•
triode safety		•		•	•	•	•	•	•	•	•	•	•	•	•
emission failure		•		•	•	•	•	•	•	•	•	•	•	•	•
snif. probe clogged		•		•	•	•	•	•	•	•	•	•	•	•	•
high. vac pump speed		•	•	•	•	•	•	•	•	•	•	•	•	•	•
cell.troubles		•	•	•	•	•	•	•	•	•	•	•	•	•	•
cell pres.>0.01 mbar			•	•	•	•	•	•	•	•	•	•	•	•	•
high. vac pump fail			•	•	•	•	•	•	•	•	•	•	•	•	•
cell pres.>1e-04 mbar			•	•	•	•	•	•	•	•	•	•	•	•	•
filaments #1 bad			•	•	•	•	•	•	•	•	•	•	•	•	•
no collector voltage			•	•	•	•	•	•	•	•	•	•	•	•	•
time keeper ram fail.			•	•	•	•	•	•	•	•	•	•	•	•	•
cell. gauge failure			•	•	•	•	•	•	•	•	•	•	•	•	•
rough. pump failure			•	•	•	•	•	•	•	•	•	•	•	•	•
primary pump failure			•	•	•	•	•	•	•	•	•	•	•	•	•
24 V DC troubles	•			•	•	•	•	•	•	•	•	•	•	•	•
mini reject point on	•													•	
check ATH connector			•							•					
check AMP connector			•								•	•	•		•
check TMP connector			•	•	•	•	•	•	•					•	
check ATH connector			•							•					
check MDP connector			•				•	•	•		•		•		•
check ATP connector			•		•				•						
LDS probe problem													•		•

Massive Function

Purpose This function allows to do gross leak localization easier.
 This function is only accessible with the remote control.

Principle The reject threshold is automatically placed at 130 % of the signal in progress at the function entry.
 This allows to detect a small signal variation from the entry but principally to place quickly the reject threshold near maximum signal detected.

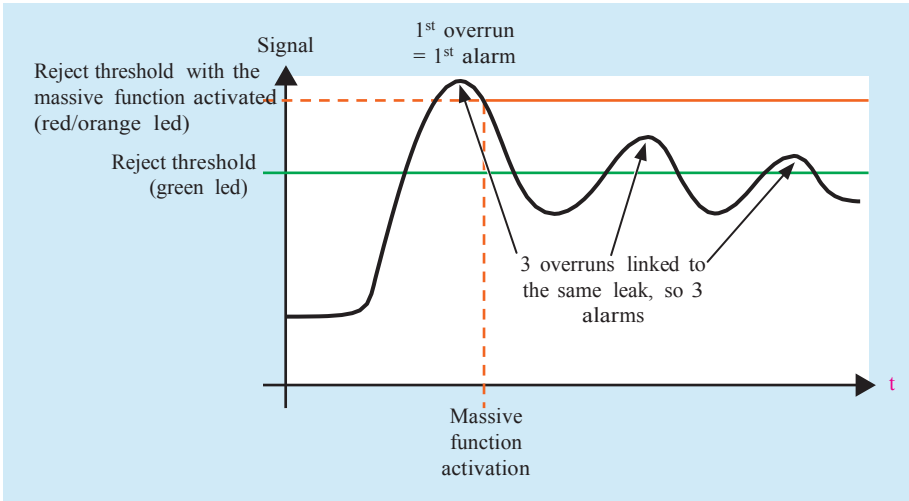

Preliminary conditions

- The remote control should be connected to the control panel.
 - The reject point flashing led should be activated ( C 212).
 - The 10 decades bargraph should be selected.
- Note: The associated warning will be displayed if the required conditions are not present at the function entry.

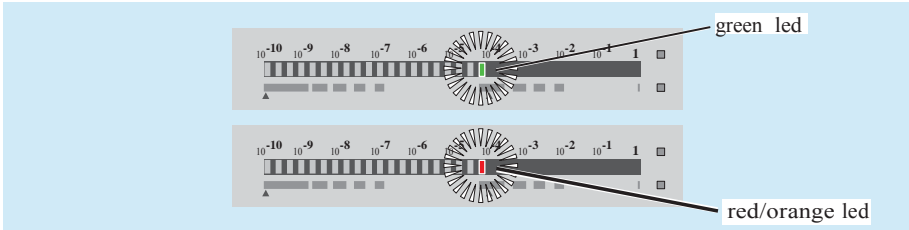

Massive Function

Start/Stop of the massive function

- To start the function, press on  key a long time until the green led becomes red/orange.

- To stop the function, press on  key a long time until the red/orange led becomes green.

The reject threshold comes back to its initial value set in the menu.

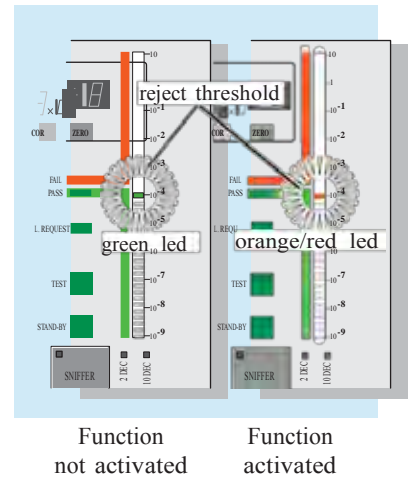

Note: Massive function activated, each time you press normally the  key, you reposition the reject threshold in process.

$$\text{Reject threshold} = \text{signal in process} \times 130 \%$$



Maintenance - Troubleshooting

ASM 142 S User's Manual

Detailed contents

Preliminary remarks Throughout this User's Manual, you could find this type of message "Summary of screen  C 140": it refers to a specific chapter of the User's Manual. Please read it for further information.

D 100

Table of preventive maintenance intervals

D 200

Maintenance message

- Definition
- Adjustment of the counters

D 210

Calibrated leak calibration supervision

- Purpose
- Principle
- Display
- Procedure





D 300

General troubleshooting guide

D 400

Symptoms description

Table of preventive maintenance intervals

Frequency*	Maintenance operations to be performed		ASM102 S	ASM122 D	ASM142	ASM142 S	ASM142 D	ASM182 T	ASM192 T	ASM192 T2	ASM182 TD+	ASM192 TD+	ASM192 T2D+	ASM1002
1000 h ⁽¹⁾	Clean filters (inlet filters, air inlet filter)	-	•	•	•	•	•							
2000 h ⁽¹⁾ or 3 months ⁽²⁾	Change the rotary vane pump oil. Change the oil mist eliminator.	 E 750			•	•		•	•	•				•
4000 h ⁽¹⁾ or 6 months ⁽²⁾	Clean the vacuum lines, the valves and the gauges with alcohol - Dust the electronic boards and the fans. Partial maintenance of the analyzer cell: Replace analyzer cell filaments and collector. Clean the analyzer cell with alcohol (this cleaning may be necessary in case of general internal contamination creating insulating deposits).	 E 400	•	•	•	•	•	•	•	•	•	•	•	•
8000 h ⁽¹⁾ or 1 year ⁽²⁾	Sniffer probe filter replacement if used.	 G 200	•	•	•	•	•	•	•	•	•	•	•	•
	Pirani gauge adjustment.	CS						•	•	•	•			•
	AP 1004 gauge adjustment.	CS		•										•
	Electronic overhaul	-		•										
	Replace the seal in the rotary vane pump.	CS						•	•					•
	AMD1 pump: replacement of membranes and check valves. Change the inlet filter of the test chamber.	 E 710					•							
10000 h ⁽¹⁾	Replacement of membranes and replacement of valves.	CS	•											
	Primary pump maintenance/ replacement of membranes and valves.	CS		•										

CS : Please contact Customer Service







*Service intervals: The service intervals given are for applications and work rates which conform to the normal operating conditions. If the machine is operating under more difficult conditions they can be shortened.

(1) running time

(2) running time or storage

(3) storage

Table of preventive maintenance intervals

Frequency*	Maintenance operations to be performed		ASM 102 S	ASM 122 D	ASM 142	ASM 142 S	ASM 142 D	ASM 182 T	ASM 192 T	ASM 192 T2	ASM 182 TD+	ASM 192 TD+	ASM 192 T2D+	ASM 1002
12000 h ⁽¹⁾	Regrease the molecular pump.	 E 740	•				•	•	•	•	•		•	
	Regrease the turbomolecular pump.	 E 740						•	•	•	•		•	
	Regrease the ATP 100 or ATH 164 pump.	 E 730								•			•	•
	Regrease the AMP007I molecular pump.	CS			•	•	•							
15000 h ⁽¹⁾	Replace the ball bearings of the ATH31 pump.	CS		•										
16000 h ⁽¹⁾ or 2 years ⁽³⁾	Recalibration/exchange of the internal calibrated leak or calibrated leak used for calibration.	 E 570	•	•		•	•	•	•	•	•		•	•
	Complete service of the rotary vane pump.	CS			•	•		•	•	•				•
22000 h ⁽¹⁾ or 1 year ⁽³⁾	Replace the ball bearings and the seals of the molecular pump and turbomolecular pump.	 E 740						•	•	•	•		•	
	Replace the ball bearings and the seal of the ATP 100 or ATH 164 pump.	 E 730								•			•	•
	Complete maintenance of dry pump (ACP 28 pump).	CS									•		•	
24000 h ⁽¹⁾ or 1 year ⁽³⁾	Replace the ball bearings and the seals of the molecular pump.	CS	•		•	•	•							
500000 cycles	Change the valves.	 E 530	•	•	•	•	•	•	•	•	•	•	•	•
Every 2 years	Change ATH31 pump ball bearings if the leak detector has not been used.		•											

CS : Please contact Customer Service

*Service intervals: The service intervals given are for applications and work rates which conform to the normal operating conditions. If the machine is operating under more difficult conditions they can be shortened.

- (1) running time
(2) running time or storage
(3) storage

Maintenance message

Definition The Maintenance messages will be display on the LCD in order to inform the operator to do a operation:
 The operator should adjust the periodicity of the appearance of this message.
 These messages concern (according to the leak detector model):

- The primary pump,
- The high vac. pump,
- The periodicity of maintenance (use time).

Adjustment of the counters

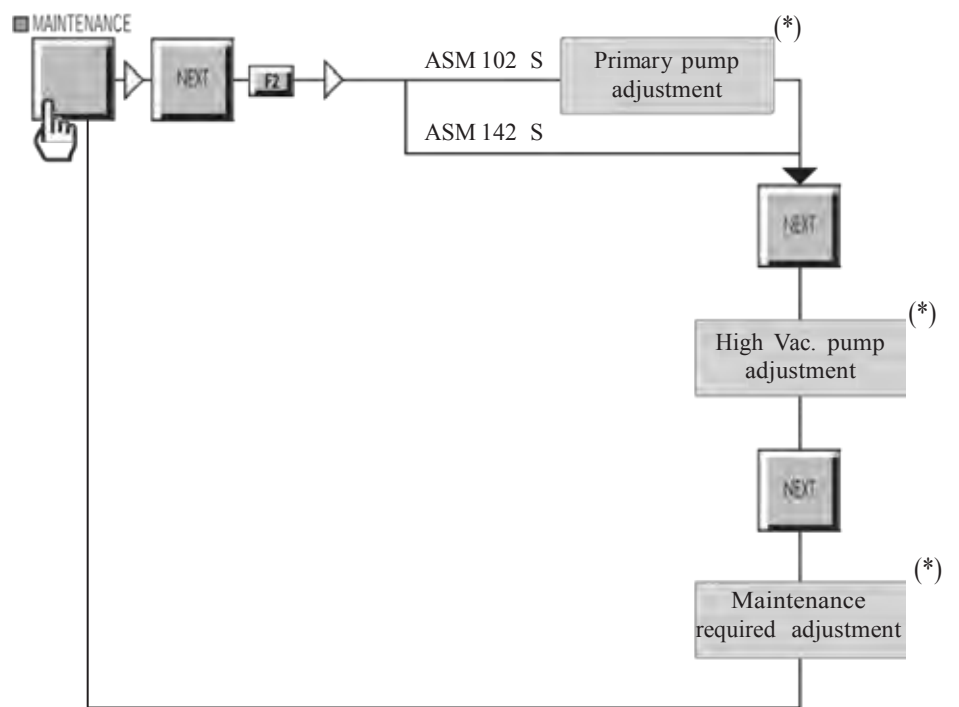

(*) ...pump adjustment
 Maint. required adjustment

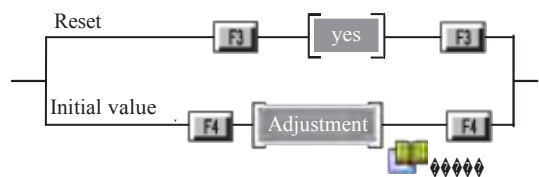

Calibrated leak calibration supervision

Purpose The supervision purpose is to remember to the operator to perform a recalibration of the calibrated leaks used for the calibration. The operator could use different calibrated leaks with the detector: it is the calibrated leak in use process which is supervised.



Only the external calibrated leaks whose all the parameters were parametered ("more parameters on leak sticker: "yes" in the spectro menu) could be supervised.

( C 305)

Principle Taking into account the leak calibration date and the recalibration periodicity set, an information message is sent 2 months before the planned recalibration date, on the detector LCD screen. This message will display:

- at each detector starting up.
- each day at 14:00 (local time) until the calibrated leak is recalibrated/changed.

ASM 142 S : The message specifies which calibrated leak should be recalibrated (internal / external).

Display The remaining time before the next recalibration is displayed in the Maintenance menu.

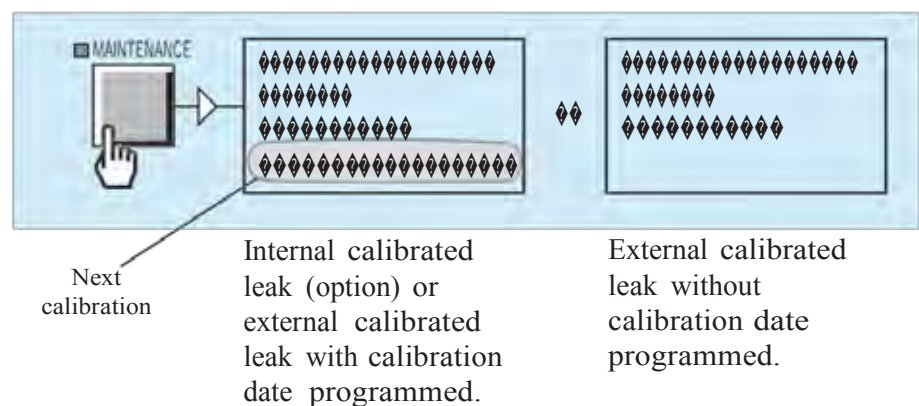

Calibrated leak calibration supervision

Procedure After the leak recalibration, the operator should set the new leak values ( C 305), the last calibration date, and its validy period.

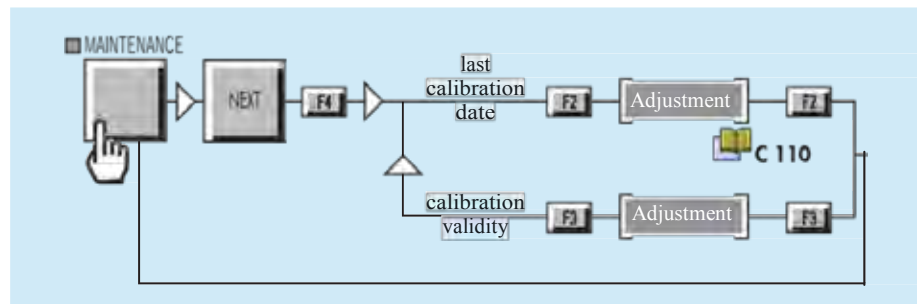

Note: This menu is not available in the case of the external calibrated leak whose the "more parameters on leak sticker" parameters is set on "no".

General troubleshooting guide

	 D 400	ASM102 S	ASM122 D	ASM142	ASM142 S	ASM142 D	ASM182 T	ASM192 T	ASM192 T2	ASM182 TD+	ASM192 TD+	ASM192 T2D+	ASM1002
Power supply													
Nothing happens when the power is switched ON	41	•	•	•	•	•	•	•	•	•	•	•	•
No display appears on the control panel	42	•	•	•	•	•	•	•	•	•	•	•	•
Rotary vane pump (RVP)													
No noise from the rotary vane pump	55			•	•		•	•	•				•
Abnormal noise from the rotary vane pump	56			•	•		•	•	•				•
Molecular / Turbomolecular pump													
Pump failure	52	•		•	•	•	•	•	•	•	•	•	•
Pump speed	53	•		•	•	•	•	•	•	•	•	•	•
Pump connector	54	•		•	•	•	•	•	•	•	•	•	•
Membrane pump													
The pump does not start	57	•											
Dry pump (ACP 28)													
No noise from the dry pump	63									•	•	•	
Dry pump has stopped during cycle	64									•	•	•	
Dry pump (Vacuubrand)													
Pump fails to start or stop immediately	65		•										
Pump doesn't achieve ultimate total pressure or normal pumping speed	66		•										
Pump too noisy	67		•										
No noise from the primary pump	68		•										
Hybrid pump (ATH 31)													
High Vac / Roughing pump does not start	58		•										
High Vac pump fails to reach nominal speed	59		•										
Roughing pump fails to reach nominal speed	60		•										
Roughing pump nominal speed lost	61		•										
Dry pump (KNF)													
Autocal fault with a high background	62	•											

General troubleshooting guide

	D 400	ASM 102 S	ASM 122 D	ASM 142	ASM 142 S	ASM 142 D	ASM 182 T	ASM 192 T	ASM 192 T2	ASM 182 TD+	ASM 192 TD+	ASM 192 T2D+	ASM 1002
Analyzer cell													
Cell pressure > 0.01 mbar	7	•	•	•	•	•	•	•	•	•	•	•	•
Cell pressure > 1 x 10 ⁻⁴ mbar	8	•	•	•	•	•	•	•	•	•	•	•	•
Cell gauge failure	9	•	•	•	•	•	•	•	•	•	•	•	•
Filaments #1 & #2 bad	10	•	•	•	•	•	•	•	•	•	•	•	•
Fil 1/Fil 2 - collector short	11	•	•	•	•	•	•	•	•	•	•	•	•
No collector voltage	12	•	•	•	•	•	•	•	•	•	•	•	•
Cell pressure safety	13	•	•	•	•	•	•	•	•	•	•	•	•
Triode safety	14	•	•	•	•	•	•	•	•	•	•	•	•
Emission failure	15	•	•	•	•	•	•	•	•	•	•	•	•
No cell pressure display	69	•	•	•	•	•	•	•	•	•	•	•	•
Inlet pressure													
Inlet pressure display doesn't show atm pressure	16		•	•		•	•	•	•	•	•	•	•
No vent (VENT ON requested)	17		•	•		•	•	•	•	•	•	•	•
No inlet pressure display	18		•	•		•	•	•	•	•	•	•	•
No inlet pressure drop at start of a cycle	19		•	•		•	•	•	•	•	•	•	•
Impossible to reach the selected test mode	20		•	•		•	•	•	•	•	•	•	•
No test chamber opening at the cycle end (pass/fail mode)	21		•	•		•	•	•	•	•	•	•	•
No test chamber opening at the cycle end (asm mode)	22		•	•		•	•	•	•	•	•	•	•

General troubleshooting guide

	D 400	ASM 102 S	ASM 122 D	ASM 142	ASM 142 S	ASM 142 D	ASM 182 T	ASM 192 T	ASM 192 T2	ASM 182 TD+	ASM 192 TD+	ASM 192 T2D+	ASM 1002
Calibration													
Start-up Auto-cal failure	31		•	•		•	•	•	•	•	•	•	•
Auto-cal failure: cal. leak year error	32	•	•	•	•	•	•	•	•	•	•	•	•
Temperature too low, Auto-cal failure temperature limits	33		•	•	•	•	•	•	•	•	•	•	•
Auto-cal failure: helium pollution	34	•	•	•	•	•	•	•	•	•	•	•	•
Cell zero limits or cell zero stability	35	•	•	•	•	•	•	•	•	•	•	•	•
Auto-cal failure: peak locating error	36	•	•	•	•	•	•	•	•	•	•	•	•
Auto-cal failure: peak adjust error	37	•	•	•	•	•	•	•	•	•	•	•	•
Auto-cal failure: emission loss	38	•	•	•	•	•	•	•	•	•	•	•	•
Impossible to start an Auto-cal	39	•	•	•	•	•	•	•	•	•	•	•	•
Impossible to reach desired target value	40	•	•	•	•	•	•	•	•	•	•	•	•
Helium measurement													
High helium background signal (in stand-by mode)	43		•	•		•	•	•	•	•	•	•	•
High helium background signal (in hard vacuum test mode)	44		•	•		•	•	•	•	•	•	•	•
Helium signal unstable	45	•	•	•	•	•	•	•	•	•	•	•	•
No test cycle start at the test chamber closing	46		•	•		•	•	•	•	•	•	•	•
LDS test													
High helium background	47	•	•	•	•	•	•	•	•	•	•	•	•
Helium signal unstable	48	•	•	•	•	•	•	•	•	•	•	•	•
Sniffer probe clogged	49	•	•	•	•	•	•	•	•	•	•	•	•
Inconsistent Helium signal	50	•	•	•	•	•	•	•	•	•	•	•	•

General troubleshooting guide

	D 400	ASM 102 S	ASM 122 D	ASM 142	ASM 142 S	ASM 142 D	ASM 182 T	ASM 192 T	ASM 192 T2	ASM 182 TD+	ASM 192 TD+	ASM 192 T2D+	ASM 1002
Operator interface													
“!” or “i” appears at the end of line 1 on LCD	23	•	•	•	•	•	•	•	•	•	•	•	•
“AL” appears on the digital display at the start	70				•								
Helium signal digital display flashing	24	•	•	•	•	•	•	•	•	•	•	•	•
Password lost	25	•	•	•	•	•	•	•	•	•	•	•	•
Timekeeper ram failure	26	•	•	•	•	•	•	•	•	•	•	•	•
Remote control keys inactive	28	•	•	•	•	•	•	•	•	•	•	•	•
Helium signal or inlet pressure analog display abnormally lit	27	•	•	•	•	•	•	•	•	•	•	•	•
Temperature													
Temperature too low/high	51		•	•	•	•	•	•	•	•	•	•	•
Appearance of information messages													
Maintenance required		•	•	•	•	•	•	•	•	•	•	•	•
Auto-cal required	2	•	•	•	•	•	•	•	•	•	•	•	•
Auto-cal aborted	3	•	•	•	•	•	•	•	•	•	•	•	•
Manual auto-cal	4		•	•		•	•	•	•	•	•	•	•
New Fil#1 / Fil#2 required	5	•	•	•	•	•	•	•	•	•	•	•	•
Filament request off	6	•	•	•	•	•	•	•	•	•	•	•	•

Symptoms description

SYMPTOM	ORIGIN / DIAGNOSTIC CONFIRMATION	REMEDY	
1 Maintenance required	Number of cycles before maintenance obsolete	<ul style="list-style-type: none"> • Refer to the table of preventive maintenance intervals • Reset the counter 	D 100 D 200
2 Auto-cal required	An auto-calibration is required	<ul style="list-style-type: none"> • Start an auto-calibration 	C 301
3 Auto-cal aborted	The auto-calibration is stopped before the end of the auto-cal cycle	<ul style="list-style-type: none"> • Restart an auto-calibration 	C 301
4 Manual calibration	In spectro menu, auto-cal is off		C 302
5 New fil #1 / #2 required	The fil #1 / #2 is burned	<ul style="list-style-type: none"> • Change the fil #1 / #2 	E 400
6 Filament request off	The filament is switched off	<ul style="list-style-type: none"> • In Spectro menu, switch on the filament 	E 400
7 Cell pres. > 0.01 mbar	Analyzer cell pressure too high / leak (spectro P11 safety activated)	<ul style="list-style-type: none"> • Check tightness of the analyzer cell • Eliminate the leak 	
8 Cell pres. > 1e-04 mbar	Analyzer cell pressure too high / leak (triode safety activated)	<ul style="list-style-type: none"> • Keep pumping the cell for 10 min (in stand-by mode) • If the trouble is not eliminated check tightness of the analyzer cell • Eliminate the leak 	
9 Cell gauge failure	Analyzer cell - spectro P11 safety damage	<ul style="list-style-type: none"> • Contact Customer Service 	
10 Filaments bad	Both filaments broken	<ul style="list-style-type: none"> • Replace filaments 	E 400
11 Fil 1/Fil 2 collector short	Short circuit in the cell (fil 1 (fil 2) collector shunt message)	<ul style="list-style-type: none"> • Eliminate the short circuit in the cell 	E 400
12 No collector voltage	Supervisor board P0302 or P0320 board	<ul style="list-style-type: none"> • Contact Customer Service 	
13 Cell pressure safety	Analyzer cell pressure too high / leak or air inlet (spectro P11 safety activated)	<ul style="list-style-type: none"> • Keep pumping the cell for 10 min (in stand-by mode) • If the trouble is not eliminated check tightness of the analyzer cell • Eliminate the leak and check the state of the filaments 	

Symptoms description

SYMPTOM	ORIGIN / DIAGNOSTIC CONFIRMATION	REMEDY	
14 Triode safety	Analyzer cell pressure too high / leak (triode safety activated)	<ul style="list-style-type: none"> • Keep pumping the cell for 10 min (in stand-by mode) • If the trouble is not eliminated check tightness of the analyzer cell • Eliminate the leak and check the state of the filaments 	
15 Emission failure	Filament off - During cycle, the calibration is defective	<ul style="list-style-type: none"> • Check or replace the defective filament 	E 400
16 Inlet pressure display does not show atmospheric pressure	Inlet port not vented (Inlet vent OFF on LCD) NO Inlet gauge adjustment	<ul style="list-style-type: none"> • Select Inlet Vent ON • Contact Customer Service 	E 400
17 No inlet vent (inlet vent ON requested)	Vent valve coil - Check valve V _{AI} connections and coil status NO Supervisor board P0302	<ul style="list-style-type: none"> • Change valve V_{AI} if faulty: <ul style="list-style-type: none"> - Minisol/bacosol - VAT: Contact Customer Service • Contact Customer Service 	E 530
18 No inlet pressure display	Inlet gauge adjustment NO Inlet pressure gauge failure (impossible to adjust it)	<ul style="list-style-type: none"> • Contact Customer Service • Contact Customer Service 	
19 No inlet pressure drop at start of a cycle	Inlet gauge head disconnected Hard vacuum test cycle unauthorized (a sound is emitted when the cycle control key is pressed) Fuse on the P0318 board defective (<i>only 182/192 series</i>) Roughing valve V _R defective	<ul style="list-style-type: none"> • Secure proper inlet pirani gauge head connection • Check leak detector status: example: check that SNIFFING test is not selected • Replace the fuse • Change the coil or the valve 	

Symptoms description

SYMPTOM	ORIGIN / DIAGNOSTIC CONFIRMATION	REMEDY	
<p>20 Impossible to reach the selected mode</p> <p><i>Leak detector with a blank at the inlet (a volume can be a source of outgazing).</i></p>	<p>Leak detector configuration (Inlet pressure compatible with desired test mode)</p> <p style="text-align: center;">NO</p> <p>Inlet pirani gauge adjustment</p> <p style="text-align: center;">NO</p> <p>Internal leak</p> <p style="text-align: center;">NO</p> <p>Primary pump</p> <p style="text-align: center;">NO</p> <p>Molecular or turbomolecular pump</p> <p>Fuse on the P0318 board defective (<i>only 182/192 series</i>)</p> <p>Detection valve defective</p>	<ul style="list-style-type: none"> • Check selected test mode consistency • Contact Customer Service • Check the tightness of the valves, seals... • Check primary pump limit pressure • Repair if necessary • If RVP, change the oil • Check the pump is rotating • Replace the fuse • Change the coil or the valve 	C 210
<p>21 No test chamber opening at the cycle end Mode: pass/fail</p>	<p>Part good, green light on</p>	<ul style="list-style-type: none"> • Check and set inlet vent parameters 	C 500
<p>22 No test chamber opening at the cycle end Mode: asm</p>	<p>Cycle and memo functions not active</p> <p style="text-align: center;">NO</p> <p>Part good, green light on</p>	<ul style="list-style-type: none"> • Set functions • Check and set inlet vent parameters 	C 550 C 530 C 500
<p>23 « ! » or « i » appears at the end of line 1 on the LCD</p>	<p>Fault or information display activated</p>	<ul style="list-style-type: none"> • Press NEXT to display the clear message 	C 580
<p>24 Helium signal digital display flashing</p>	<p>Fault display activated (Er alternately displayed with helium signal)</p>	<ul style="list-style-type: none"> • Press NEXT to display the clear message 	C 580
<p>25 Password lost</p>	<p>Impossible to access to the menus</p>	<ul style="list-style-type: none"> • Contact Customer Service 	

Symptoms description

SYMPTOM	ORIGIN / DIAGNOSTIC CONFIRMATION	REMEDY	
26 Timekeeper ram fail.	Supervisor board P0302 ram problem	<ul style="list-style-type: none"> Contact Customer Service 	
27 Helium signal or inlet pressure analog display abnormally lit	Wrong connection between remote control and control panel	<ul style="list-style-type: none"> Secure proper connection of the remote control, stop leak detector and start again 	
28 Remote Control keys inactive	Remote control disconnected (no LED and display on the remote)	<ul style="list-style-type: none"> Secure proper connection of the remote control. If remote control display is erratic, after reconnection, stop leak detector and start again 	
	<p style="text-align: center;">NO</p> Autocal key deactivated (Beep emitted when Autocal key is pressed)	<ul style="list-style-type: none"> Leak detector is in test mode: external calibration is available on the control panel only Stop test cycle to start an internal autocalibration 	C 301
31 Start-up Auto-cal failure	Filament status OFF	<ul style="list-style-type: none"> Select filament status ON in the spectro menu and start an Auto-cal 	E 400
32 Auto-cal failure: cal. leak year error	Incorrect internal calibrated leak parameters	<ul style="list-style-type: none"> Check and correct internal calibrated leak parameters 	C 305
33 Temperature too low/high Auto-cal failure temperature limits	Temperature sensor disconnected	<ul style="list-style-type: none"> Secure proper temp. captor connection to the internal calibrated leak 	
	<p style="text-align: center;">NO</p> Ambient temperature	<ul style="list-style-type: none"> Make sure the leak detector is used within ambient temperature tolerance 	A 800
	<p style="text-align: center;">NO</p> Fan(s) failure	<ul style="list-style-type: none"> Check fan status and replace faulty fan(s) 	
34 Auto-cal failure: helium pollution	High background (helium signal is higher to the calibrated leak value used for the calibration)	<ul style="list-style-type: none"> Degassing in the analyzer cell: keep pumping the cell for 10 min (in stand-by mode) and start an autocalibration If the trouble is not eliminated, look for possible leaks or oil contamination (for RVP) 	E 750

Symptoms description

SYMPTOM	ORIGIN / DIAGNOSTIC CONFIRMATION	REMEDY	
35 Cell zero limits or Cell zero stability	VHS adjustment NO Electronic problem	<ul style="list-style-type: none"> Contact Customer Service 	
36 Auto-cal failure: peak locating error	Problem of the calibration valve NO	<ul style="list-style-type: none"> Check valve V_{C3} 	E 530
	Peak fault: internal calibrated leak damaged (lack of helium) NO	<ul style="list-style-type: none"> Check internal calibrated leak parameters Check consistency between measurement of the internal and the external calibrated leak 	C 305 C 300
	NO Incorrect filament alignment NO	<ul style="list-style-type: none"> Change internal calibrated leak 	
	Peak fault: analyzer cell incorrect assembly	<ul style="list-style-type: none"> Check and adjust filament position 	E 400
37 Auto-cal failure: peak adjust error	Peak fault: internal calibrated leak parameters NO	<ul style="list-style-type: none"> Check the analyzer cell 	E 400
	Incorrect filament alignment NO	<ul style="list-style-type: none"> Check that the calibration parameters are correct 	C 305
	Peak fault: analyzer cell incorrect assembly	<ul style="list-style-type: none"> Check and adjust filament position 	E 400
38 Auto-cal failure: emission loss	Problem of the calibration valve	<ul style="list-style-type: none"> Check the analyzer cell 	E 400
39 Unable to start an autocalibration	Manual calibration selected NO	<ul style="list-style-type: none"> Check valve V_{C3} 	E 530
	Leak detector is in test mode (remote control AUTOCAL key inactive)	<ul style="list-style-type: none"> Select automatic calibration 	C 302
		<ul style="list-style-type: none"> The control panel AUTOCAL key is only active to start an external calibration For internal auto-calibration, stop the test cycle 	C 301

Symptoms description

SYMPTOM	ORIGIN / DIAGNOSTIC CONFIRMATION	REMEDY	
40 Unable to reach target value	Incorrect internal calibrated leak parameters	<ul style="list-style-type: none"> • Check and correct internal calibration leak parameters 	C 305
	<p style="text-align: center;">NO</p> Internal calibrated leak faulty (check helium signal with an external calibrated leak)	<ul style="list-style-type: none"> • Change/recalibrate internal calibrated leak 	E 560
41 Nothing happens when the power is switched ON	Power fuse burnt	<ul style="list-style-type: none"> • Change fuse and check power voltage 	
42 No display appears on the control panel	Control panel disconnected from supervisor board	<ul style="list-style-type: none"> • Secure proper control panel connection. 	
	<p style="text-align: center;">NO</p> Power supply board trouble	<ul style="list-style-type: none"> • Change fuse of the power supply board or contact Customer Service 	
	<p style="text-align: center;">NO</p> Control panel trouble	<ul style="list-style-type: none"> • Change control panel board 	
43 High helium background signal (in stand-by mode)	Rotary vane pump Pollution (if RVP)	<ul style="list-style-type: none"> • Open air ballast • Change the oil or contact customer service. 	E 750
	<p style="text-align: center;">NO</p> Leak inside the leak detector	<ul style="list-style-type: none"> • Helium leak: check the valves 	
	<p style="text-align: center;">NO</p> Analyzer cell contamination	<ul style="list-style-type: none"> • Clean and recondition the cell 	E 400
	<p style="text-align: center;">NO</p> Ambient air helium contamination (background OK when leak detector placed in another room or environment, free of helium contamination)	<ul style="list-style-type: none"> • Clean the ambient air 	
44 High helium background signal (in hard vacuum test mode)	Tested piece degassing (background OK in test mode when leak detector inlet port blanked off)	<ul style="list-style-type: none"> • Clean the part/installation being testing. Eliminate the source of degassing or contamination 	

Symptoms description

SYMPTOM	ORIGIN / DIAGNOSTIC CONFIRMATION	REMEDY	
45 Helium signal unstable	Analyzer cell connections NO Contamination of the rotary vane pump oil (helium “peaks” at regular intervals) (if RVP)	<ul style="list-style-type: none"> • Check that the external analyzer cell connections are correct and the internal analyzer cell connections propely fastened • Change the oil 	C 400 E 750
46 No test cycle start at the test chamber closing	Sensor disconnected: sensor light off	<ul style="list-style-type: none"> • Check the sensor connection to the test chamber and the board 	
47 High helium background signal	Ambient air helium contamination (background OK when leak detector placed in another room or environment, free of helium contamination) NO Internal LDS plastic tube disconnected (background decreases very slowly when sniffer probe tip is blocked with a finger)	<ul style="list-style-type: none"> • Clean ambient air • Repair LDS probe tube (tightness of connectors) or change LDS probe 	G 200
48 Helium signal unstable	Ambient source of helium contamination	<ul style="list-style-type: none"> • Check possible sources of helium emission in the surroundings • Eliminate or isolate it 	

Symptoms description

SYMPTOM	ORIGIN / DIAGNOSTIC CONFIRMATION	REMEDY	
49 LDS probe clogged	LDS probe filter clogged (message disappears when the filter is removed)	<ul style="list-style-type: none"> • Change LDS probe filter 	G 200
	NO		
	Other part of the LDS probe clogged (no helium signal change when the probe tip is blocked with a finger)	<ul style="list-style-type: none"> • Clean LDS probe tube with needle or change LDS probe 	G 200
	Sniffer probe clogged set point adjustment too high (leak detector autocalibrated)	<ul style="list-style-type: none"> • Check sniffer probe clogged set point value • Adjust it 20 % of the ambient helium signal 	G 211
50 Inconsistent Helium signal	Fine signal adjustment required	<ul style="list-style-type: none"> • Make an external calibration in sniffing mode 	C 303
51 Temperature too low/high	Ambient temperature sensor	<ul style="list-style-type: none"> • Make sure the leak detector is used within ambient temperature tolerance 	A 800
52 Pump failure	Overheating	<ul style="list-style-type: none"> • Check the connections : unplug and plug the cables on the P0326 board and the pump 	
	Mechanical hard spot (does not spin freely by hand)	<ul style="list-style-type: none"> • Contact Customer Service 	

Symptoms description

SYMPTOM	ORIGIN / DIAGNOSTIC CONFIRMATION	REMEDY	
<p>53 Pump speed</p>	<p>P0326 switch is in running-in</p> <p style="text-align: center;">NO</p> <p>The exhaust pressure of the pump is not correct (≤ 5 mbar)</p> <p style="text-align: center;">NO</p> <p>The exhaust valve has not opened</p> <p style="text-align: center;">NO</p> <p>Leaks inside the leak detector</p> <p style="text-align: center;">NO</p> <p>Greasing of the pump ball bearings to be performed</p> <p style="text-align: center;">NO</p> <p>Mechanical hard spot (does not spin freely by hand)</p>	<ul style="list-style-type: none"> • Check the pump • Check the gross leak valve • Check the tightness of the canalisations, valves, pumps and cell (alcohol test or use of another detector) • Regrease the pump ball bearings • Replace the pump or • Contact Customer Service 	<p>E 530</p> <p>E 740</p>
<p>54 Check the pump connection</p>	<p>Pump is not connected with pump controller board P0326</p>	<ul style="list-style-type: none"> • Contact Customer Service 	
<p>55 No noise from the rotary vane pump</p>	<p>Rotary vane pump power supply not connected</p> <p style="text-align: center;">Circuit breaker switch of the rotary vane pump Impossible to keep in position 1</p> <p style="text-align: center;">Motor thermistor Internal motor temperature > 60°C</p>	<ul style="list-style-type: none"> • Connect the rotary vane pump power supply connector • Contact Customer Service • Allow the pump to cool down • If the fault persists: • Contact Customer Service 	
<p>56 Abnormal noise from the rotary vane pump</p>	<p>Oil temperature <10°C</p> <p style="text-align: center;">NO</p> <p>Symptoms of seizure: the motor binds (heats up)</p>	<ul style="list-style-type: none"> • Heat the pump body to approximately 18°C. • Contact Customer Service 	

Symptoms description

SYMPTOM	ORIGIN / DIAGNOSTIC CONFIRMATION	REMEDY
57 The pump does not start	Membrane pump seized NO Membrane cut Valve defective	<ul style="list-style-type: none"> • Change the pump • Change membranes • Change valve
58 High Vac or Roughing pump do not start	Temperature is too low NO Internal connection missing (No LED lit on the controller board) NO Pump locked (Pump speed does not exceed 4 KRPM)	<ul style="list-style-type: none"> • Install the leak detector in a room where the temperature is in the acceptable range (between 0 and 40°C) • Secure proper connections and controller identification • Contact Customer Service
59 High Vac pump fails to reach nominal speed	Controller configuration (High Vac Pump speed does not exceed 42000 RPM)	<ul style="list-style-type: none"> • Contact Customer Service
60 Roughing pump fails to reach nominal speed	Controller configuration (Roughing Pump speed does not reach 100 %)	<ul style="list-style-type: none"> • Contact Customer Service
61 Roughing pump Nominal speed lost	Large leak on the tested item (Speed OK when inlet port blanked off)	<ul style="list-style-type: none"> • Eliminate the leak if it is identified. If not, spray a little quantity of helium: a fast helium signal rise will confirm the leak
62 Autocal failure with a high background	The dry pump does not start (no noise)	<ul style="list-style-type: none"> • Change the pump
63 No noise from the primary pump	Problem on electrical module NO Pump overheating NO Mechanical jamming	<ul style="list-style-type: none"> • Contact Customer Service • Check the connections, unplug and plug the cables on the electrical module. Check the cooling system. • Contact Customer Service

Symptoms description

SYMPTOM	ORIGIN / DIAGNOSTIC CONFIRMATION	REMEDY	
64 Pump stops during cycle	Power supply voltage is less than the minimum allowed, the pump turns into safe	<ul style="list-style-type: none"> • Check the power supply voltage, stop the detector and restart the pump 	
65 Pump fails to start or stops immediately	Pressure in outlet pipeline too high NO Motor overloaded	<ul style="list-style-type: none"> • Contact Customer Service • Allow motor to cool. 	
66 Pump does not achieve ultimate total pressure or normal pumping speed	Pump has been exposed to condensate NO Deposits have been formed inside the pump NO Valves or diaphragm damaged	<ul style="list-style-type: none"> • Run pump at atmospheric pressure for a few minutes • Contact Customer Service • Contact Customer Service 	
67 Pump too noisy	Atmospheric or high pressure at inlet port NO Diaphragm clamping disc loose	<ul style="list-style-type: none"> • Connect hose to pump outlet • Contact Customer Service 	
68 No noise from the primary pump	Primary dry pump power supply not connected NO No power voltage (24 V) to the primary dry pump	<ul style="list-style-type: none"> • Connect the primary dry pump power supply connector • Contact Customer Service 	
69 No cell pressure display	Filament OFF requested NO Short circuit on triode electrode	<ul style="list-style-type: none"> • Check filament status • Eliminate the short circuit in the cell 	
70 "AL" appears on the digital display at the start.	Autocalibration failure	<ul style="list-style-type: none"> • Start a calibration. 	



Maintenance sheets

ASM 142 S User's Manual

Detailed contents

Preliminary remarks Throughout this User's Manual, you could find this type of message "Summary of screen  C 140": it refers to a specific chapter of the User's Manual. Please read it for further information.

E 100

Maintenance operations instruction

- Safety instructions
- Working conditions
- Icons used

E 110

Access to the internal components ASM 142/ASM 142 S

- Access level 1
- Access level 2

E 400

Basic maintenance of the analyzer cell

- Components
- Safety instructions
- Special precautions
- Cell disassembly
- Cleaning the body
- Disassemble the filaments
- Disassemble the electron collector
- Replace the electron collector and the filaments
- Tighten all the connection screws
- Reassemble the flange
- Tighten all the securing screws
- Restart and check proper operation of the analyzer cell
- Reset the filament information timer
- Switch on/off the filament
- Verification of the electrical zero
- Symptoms and probable cause

E 530

Valves installation and maintenance

- Valves identification
- VAT valves DN 25 / DN 40
- Vacuum activated valves
- Minisol and Bacosol valves

E 560

Exchange of the internal calibrated leak (option)

- Exchange of the internal calibrated leak
- Programming the new calibrated leak characteristics
- Calibrated leak supervision



Maintenance sheets

ASM 142 S User's Manual

Detailed contents

E 600

Remote control exchange

- Replacement of the remote control
- Remote control defective
- Remote control box exchange

E 610

Long distance sniffer probe and Helium spray gun

E 730

Starting of the molecular and turbomolecular pumps

- Restarting after stop
- Starting in the cold state
- First start up after delivery

E 750

Primary pump maintenance

- Check the oil level of the primary pump
- Add oil
- For oil contamination, drain the pump
- For dirty oil, rinse the pump
- Remove and change the oil mist eliminator

Maintenance operations instruction

Safety instructions



B 100

















The products are free of leaks when shipped from the factory, for normal operating conditions.
The user is responsible for maintaining the level of tightness.

Working conditions

During disassembly and reassembly operations on vacuum lines, to avoid gettinger due to dust or finger prints, you are advised to work:

- in a clean room,
- on lent free paper,
- with unpowdered vinyl gloves (clean room gloves),
- to dust each part with filtered dry air,
- to block all the openings in the vacuum lines.

Icons used

	2.5 mm Allen key		10 mm spanner
	3.5 mm Allen key		13 mm spanner
	3 mm Allen key		17 mm spanner
	4 mm Allen key		20 mm spanner
	5 mm Allen key		Philips head screwdriver
	6 mm Allen key		Screwdriver for slotted head screws
	12 mm stud		Voltmeter
	7 mm spanner		Ohmmeter
	8 mm spanner		

Access to the internal components ASM 142 / ASM 142 S

Access level 1

Removable cover

5

- ① Switch off the machine by setting the main switch to «0» and disconnecting the main power.
- ② Remove the inlet port clamp.
- ③ Unfasten the 4 securing screws and their washers using a 5 mm Allen key. Use a 5mm Allen wrench.
- ④ Remove upper the cover. Be careful of the front panel cable.

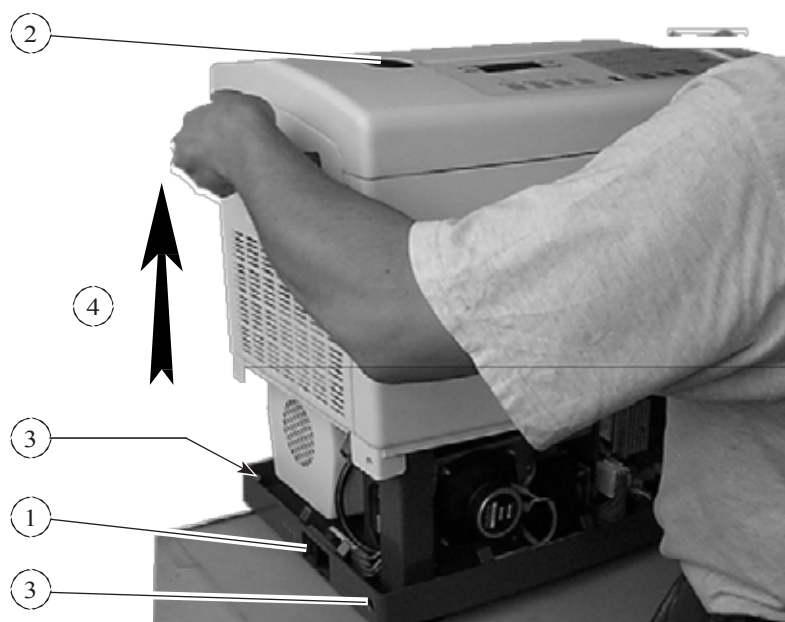

Put the cover near the detector.

- ⑤ Open the «clip» for ribbon cable.
- ⑥ If necessary, disconnect the 20 points connector.

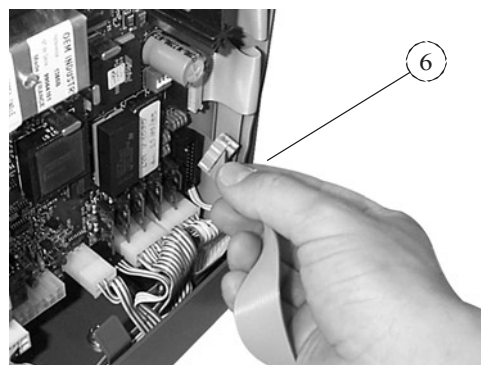
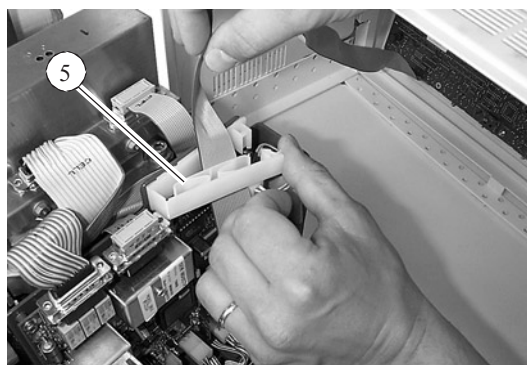

Access to the internal components ASM 142 / ASM 142 S

Access level 1 (continued)

Access to the internal calibrated leak

- Disconnect the calibrated leak temperature sensor.
- Tighten the calibrated leak clips between two fingers and pull the calibrated leak down

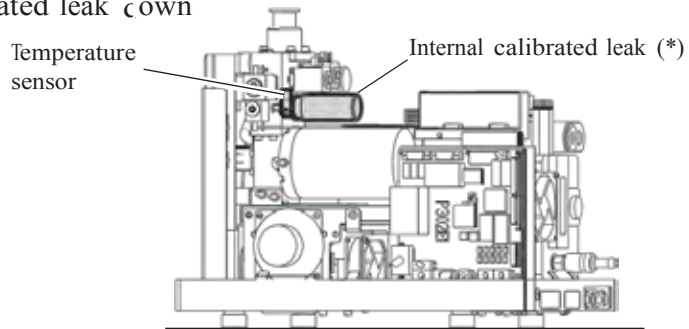

(*) ASM 142 S in option

Access level 2 To be applied after access level 1 is completed.

Access to the board P0326 and P0330

- Remove the two screws M5 and their washers ①
- Open the removable plate

5

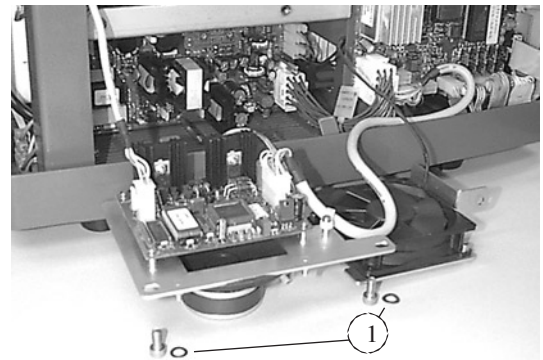
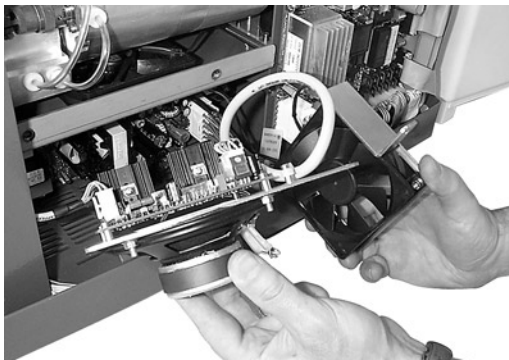

2 screws M5 + washers

Disassemble the main block

- Remove all the connections:
 - 2 connections for analyzer cell ①
 - 2 quick connectors (for valves) ②

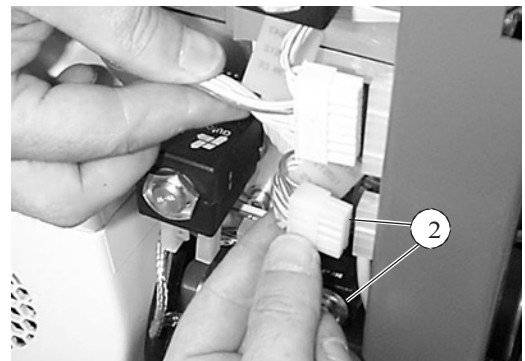
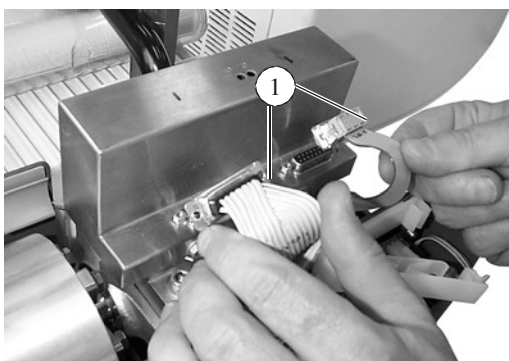

Access to the internal components ASM 142 / ASM 142 S

Access level 2
(continued)

- Disassemble the main block (continued)
- Molecular pump connector ③
 - Remove the DN 25 pumping pipe connection ④

5

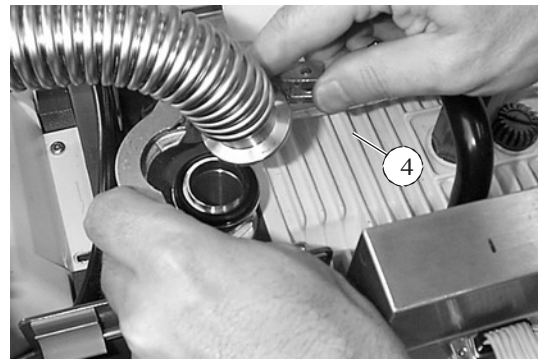
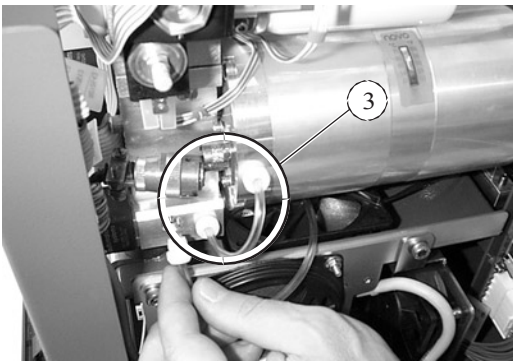

- Remove the 5 attachment screws:

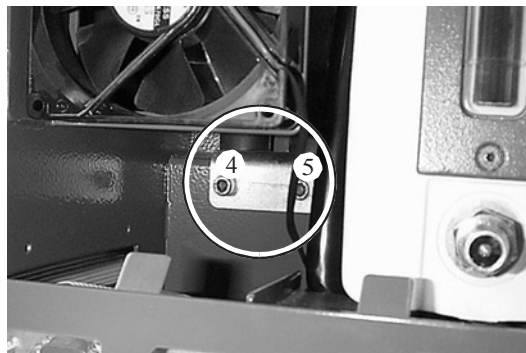
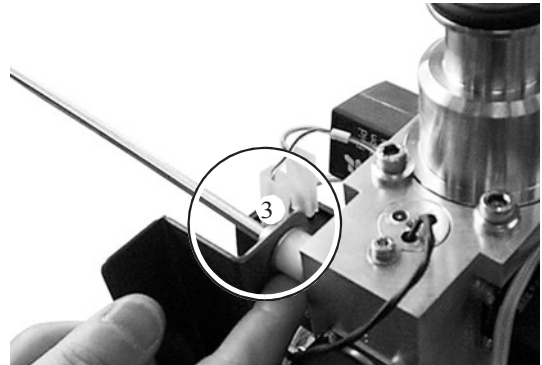
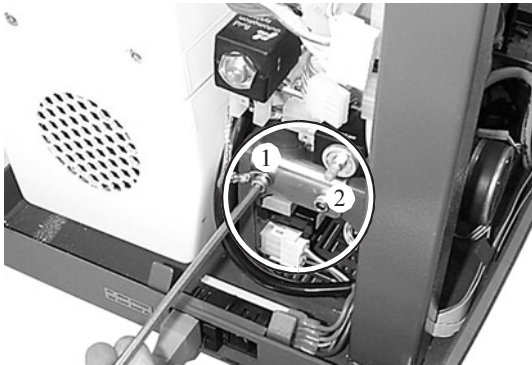

Access to the internal components ASM 142 / ASM 142 S

Access level (continued)

Disassemble the main block Disassemble the main block:
(continued)

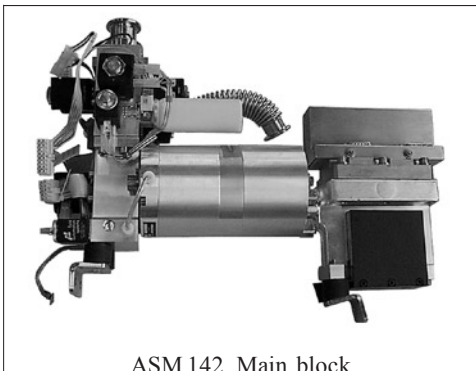
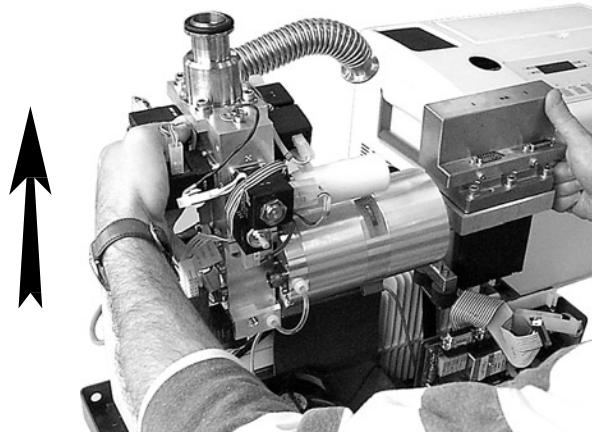

ASM 142 Main block

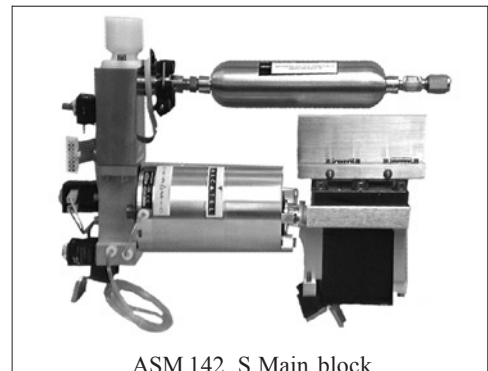

ASM 142 S Main block
with the internal calibrated leak option

Sending of a leak detector for reparation to a service center

Safety questionnaire All material which is send to a service center needs to be included with the safety questionnaire (full).
This safety questionnaire can be found in the appendix ( G 600).

Packaging It is advised to use the origin packaging for every return; the leak detector should stay firm in the packaging.
Alcatel is not responsible for damage caused by the transportation, due to a not proper packaging.

Transportation

 B 110

Basic maintenance of the analyzer cell

The frequencies of preventive maintenance tasks are listed in section  D 100.

Components

 F 500

Safety instructions

 B 100

Special precautions



Disconnect the detector from the main power.

The analyzer cell is very sensitive to any form of contamination, particularly to dust and electrostatic discharge.

When assembling, to avoid getting due to dust or finger prints, you are advised to work:

- in a clean room,
- on lint free paper,
- with unpowered vinyl gloves (clean room gloves),
- to blow off each part with filtered dry air,
- to block all the openings in the vacuum lines and the VHS preamplifier.

The operator must take all necessary measures to avoid transferring electrostatic charges during the operation.

Basic maintenance of the analyzer cell

*Replacement of the filaments and
the electron collector*

Cell disassembly

Disconnect the spectro electrically (2 connectors).

□ Unfasten the 6 securing screws and their washers using a 5 mm Allen key.

□ To extract the flange from the body use 1 security screw and screw it in the hole with internal screw turgad (see picture). Don't use a screwdriver to extract the flange, there is a risk to damage it.



5

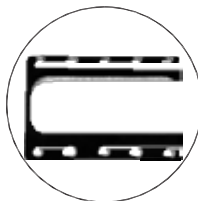
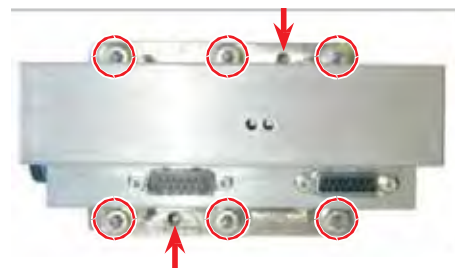

□ Place the seal on a surface protected from any contamination.

Cleaning the body

The internal duct of the body may show traces of metallization beside the filament. If traces are present, clean using abrasive paper (grit 180), aspirate the residue and complete the cleaning with alcohol.

□ Clean the surface of the flange with alcohol.

□ Clean the special metal seal bearing surface with alcohol.

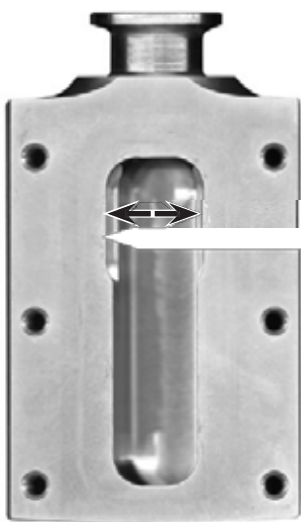

Basic maintenance of the analyzer cell

Disassemble the filaments



□ For each filament:
Remove the attachment screw
and unfasten the 2 connection
screws

Attachment screw
Connection screws

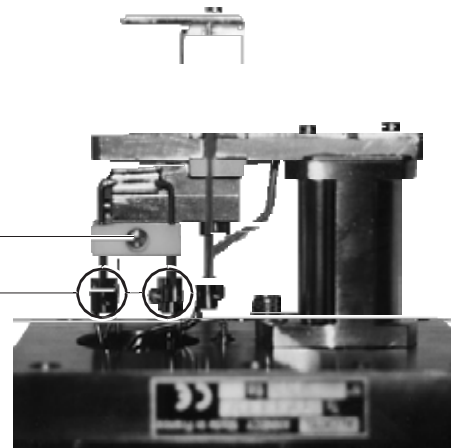

Disassemble the electron collector



□ Remove the attachment
crew

Attachment screw

Filament 2

Filament

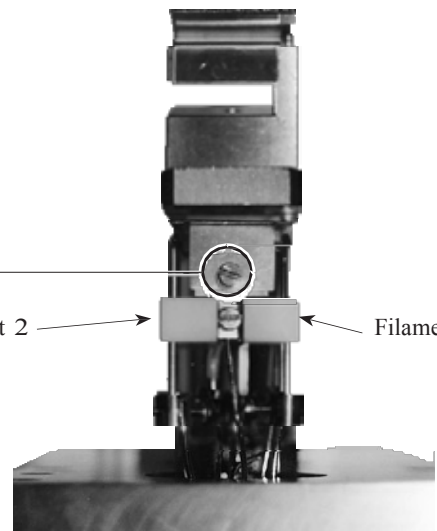

Electron collector

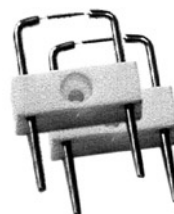

Filaments



Ion emitter

Basic maintenance of the analyzer cell

Replace
the electron collector
and the filaments

□ Fit the electron collector ① on the ion emitter by inserting the screw without tightening it completely.

□ Fit two new filaments ② (do not fasten the connections)..

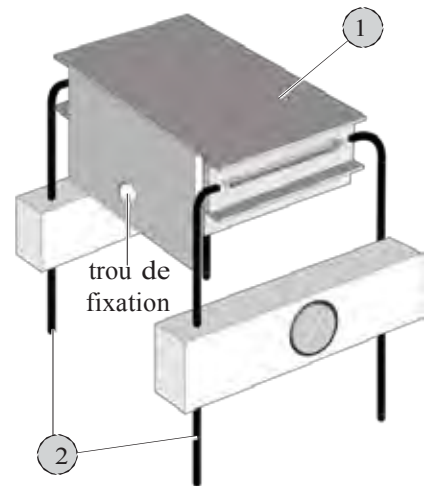

CAUTION

The good condition and correct setting of these components are decisive factors in maintaining the detector's characteristics.

The turns of each filament must be centered exactly opposite the electron collector slot:

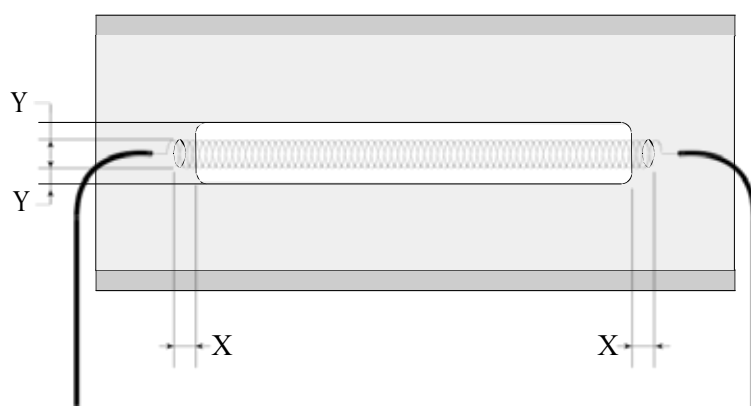

- The X values must be equal.
- The Y values must be equal.

To obtain this setting on each filament, adjust the relative positions of each filament and the electron collector before the final tightening.

Basic maintenance of the analyzer cell

Tighten all the connection screws

Make sure that all the connection screws are facing inwards and are not in contact with each other.

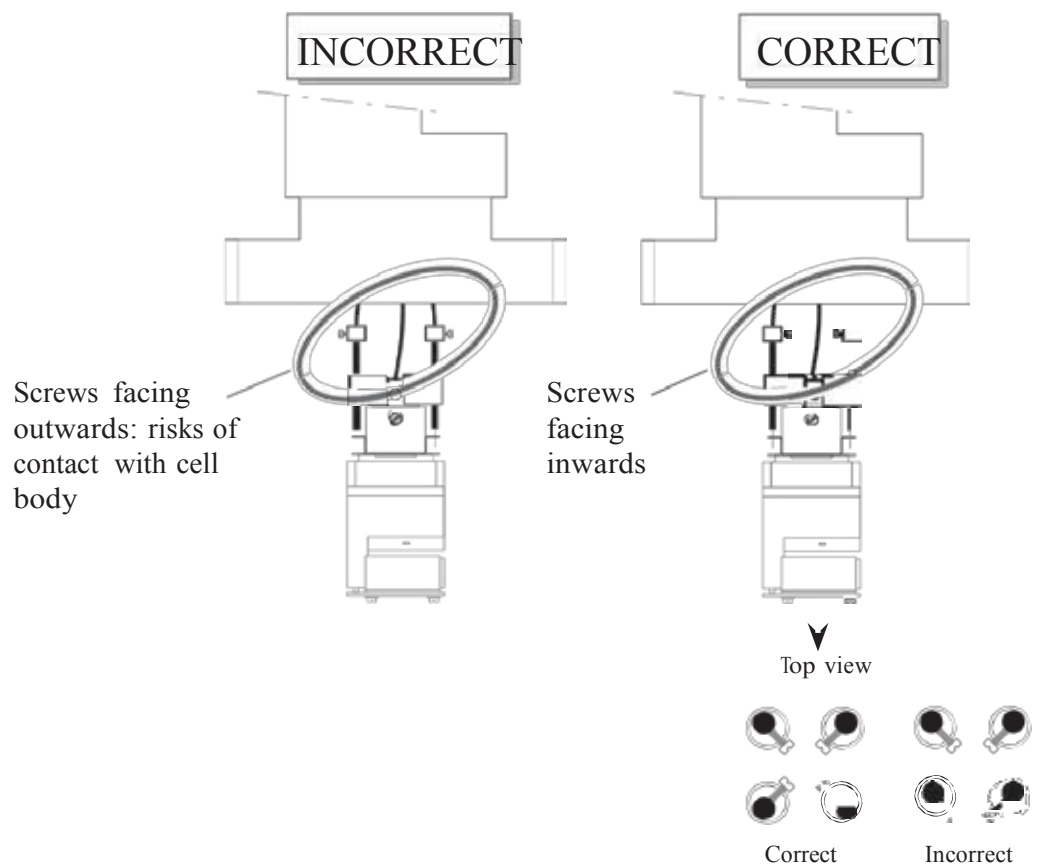

Reassemble the flange

Reposition the special elastomer seal on the body. If it is damaged, change it.

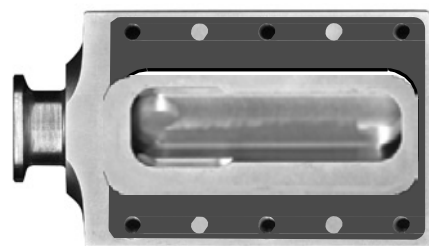

Basic maintenance of the analyzer cell

- In case the analyzer cell is equipped with the optional metal seal:
- Prepare the new special metal seal according to the figure below or using the seal former,  F 110
 - The ends of the metal seal must only cross once (no twist). Check that the ends cross near one of the six screws holes, one end on either side of the hole. Place the metal seal on the cell body seal seat

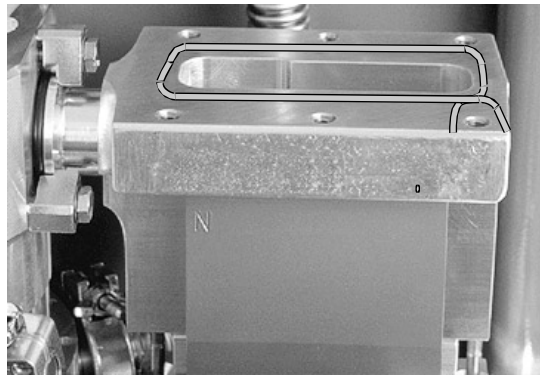

- Install the flange, taking care to lower it into the duct without touching the sides.
- Install the 6 screws.

Tighten all the securing screws

5

- Tighten the screws with their washers in the sequence shown below to a torque of 0.7 m.daN for the special elastomer seal (0.8 m.daN or 8 ft. lbs for the metal seal).



Don't takoff the black sticker

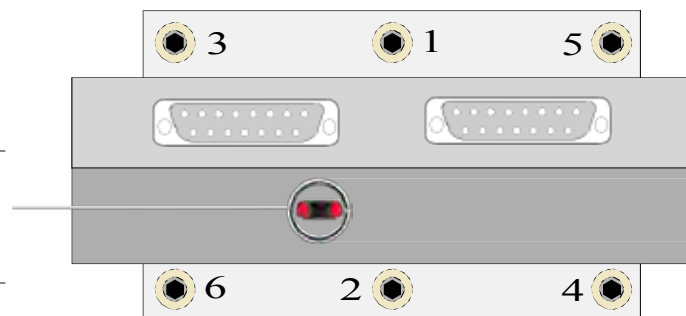

6 screws tightening order

Basic maintenance of the analyzer cell

Restart and check proper operation of the analyzer cell

Connect again the 2 plugs to the analyzer cell.

Start the leak detector.

Initial filament start and auto-calibration may fail due to exposure of the inside of the analyzer cell to atmospheric pressure during the maintenance process.

Let the detector run for a few minutes to obtain proper vacuum inside the analyzer cell.

If the filament did not light, reset it and run an auto-calibration.

Check the lightness.

Reset the filament information timer

After the basic maintenance of the analyzer cell, reset the filament information (timers).

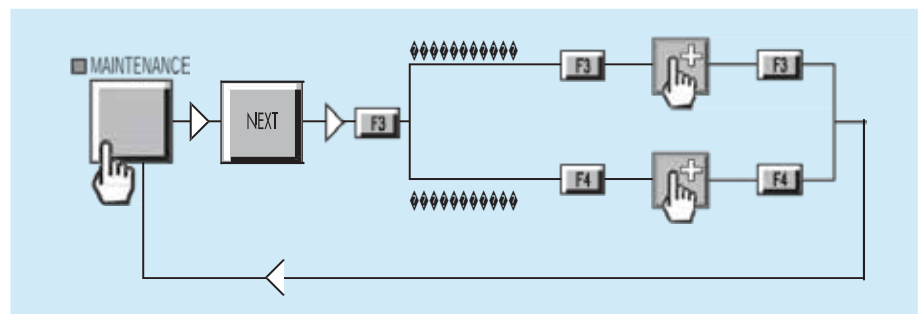

Switch on/off the filament

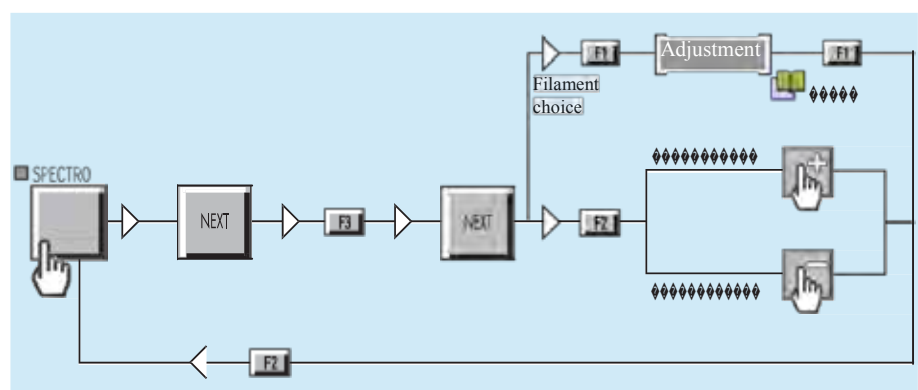

Verification of the electrical zero

Switch off the filament
 Start an auto-calibration.

In case of failure, contact the Customer's Service.

Basic maintenance of the analyzer cell

Symptoms and probable cause	Remedy
-----------------------------	--------

Filament does not light

Gross leak

Check the torque of the screws of the analyzer cell, sealing surface (spray helium to check it) and elastomer seal status. Change it if necessary

Electrical short circuit

Check electrical connections on the sub-D 15 pin male plug J2 located on the top of the analyzer cell. Dismantle and relocate correctly the internal wires and/or connections.

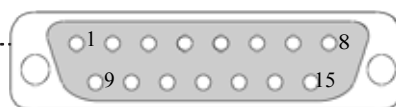

J2 sub-D male plug

J2 plug	functions	corresponding feed-throughs
2 to 6	Ground	
8	Filament 1 point B	2
12	Filament 2 point A	4
13	Filament 2 point B	5
15	Filament 1 point A	

Auto-calibration failure

(refer to defect message displayed)

Lack of sensitivity

Check filament alignment.

High background: internal

Let the leak detector run until you have a stable signal for the degassing and starting another auto-calibration.

Note: A low background gives a more accuracy measurement.

High background: leak

Spray helium around the sealing surfaces.

Valves installation and maintenance

Valves identification

• = the valve mark engraved on the vacuum block.

Example:

V_{A1}  = marked •

Operating principle ref.  A 200

Function	Type of valves	ASM 102 S	ASM 102 D	ASM 142	ASM 142 S	ASM 142 D	ASM 182 T	ASM 192 T	ASM 192 T2	ASM 182 TD+	ASM 192 TD+	ASM 192 T2D+	ASM 1002
V _{A1} Air inlet	Bacosol	•9				•6	•4	•4	•4	•4	•4	•4	•5
V _{R1} Roughing	Electromagnetic (DN 25)						•2	•2		•2	•2		
V _{R1} Roughing	Electromagnetic (DN 40)								•2			•2	
V _{R1} Roughing	Vacuum activated valve		•2										•7
V _{R1} Roughing	Bacosol			•1		•1							
V _{R2} Roughing	Bacosol			•2		•2							
V _B By-pass	Electromagnetic (DN 25)									•1	•1		
V _B By-pass	Electromagnetic (DN 40)								•1			•1	
V _{T1} Gross leak test mode	Bacosol		•4	•3	•3	•3	•5	•5	•5	•5	•5	•5	•5
V _{T1} Gross leak test mode	Minisol (*)	•2											•6
V _{T2} Normal test mode	Minisol (*)		•5										
V _{T2} Normal test mode	Bacosol			•4		•4							
V _{T3} Normal test mode	Bacosol			•5		•5							
V _{T4} High sensitivity test mode	Electromagnetic (DN 25)						•3	•3		•3	•3		
V _{T4} High sensitivity test mode	Electromagnetic (DN 40)								•3			•3	
V _{T4} High sensitivity test mode	Vacuum activated valve		•3										•9
V _S Sniffing test	Minisol (*)	•1	•11	•9	•9	•9	•9	•9	•9	•9	•9	•9	•3
V _V Buffer volume for depression valves	Minisol (*)		•1										•8
V _{AT} Atm-pressure	Minisol (*)		•10										
V _C Calibration	Minisol (*)			•7	•8	•7							
V _{C2} Calibration : High Vac.	Minisol (*)		•6				•6	•6	•6	•6	•6	•6	•4
V _{C1} Calibration : roughing	Minisol (*)		•7				•7	•7	•7	•7	•7	•7	•2
V _{C3} Calibration: air inlet	Minisol (*)		•8				•8	•8	•8	•8	•8	•8	•1
V _{G2} Gas line option	Minisol (*)									•10			
V _{G1} Gas line option	Minisol (*)									•11			

(*) Minisol valve without valve block

Valves reference  F 700

Valves VAT DN 25/DN 40

Contact Customer Service  E 531 (TRM only)

Valves installation and maintenance

Vacuum activated valves

These valves are operated with an electromagnetic control valve, and with a vacuum source.

The maintenance is the cleaning operations or the exchange of the valve.



Electromagnetic control valve

Removable assembly



VAT membrane

Valves installation and maintenance

Minisol and Bacosol valves

Periodicity



Necessary materials

Denatured alcohol (non recycled)
Paper (clean room compatible)
Gasket extractor
Glue (Loctite 542 type)



Flat screwdriver 2 x 40



Phillips screwdriver Nr 1

For these kinds of valves, neither seal kit nor sub-assembly is available.

The complete valve must be changed.



“Bacosol“ valves (Normally closed NC)
Ø 9



“Minisol“ valves without valve block (Normally open NO or NC)
Ø 6



“Minisol“ valves with valve block (NO or NC)

Valves installation and maintenance

- Precautions** Whenever handling valves, take the necessary precautions not to pollute the vacuum circuit and, to keep the valve and valve seat free of particles which create leaks.
The valve, particularly the sealing surfaces, should only be handled with clean, lint-free gloves.
It should only be installed in a clean system.
- Dismantling** For the valve assembly/disassembly, the unit must be stopped and disconnected from line power.
If "piston" O-rings are installed on the valve, use a gasket extractor to remove it. Take care not to damage the sealing surface.
Immediately protect the valve inlet if it is to stay open for a long time.

- Cleaning** Clean the surfaces of the different parts with alcohol.
For the Normally Open type Minisol valves (NO), O-rings are present on both sides of the valve.
Improve the cleaning by blowing off the parts with dry filtered air, particularly the O-ring grooves.



- Seal preparation** Place the "piston" O-rings.
A slight greasing of these rings is possible. Grease quantity should be limited to avoid helium retention and make assembly easier. Put a drop of grease on your fore-finger. Spread the grease out between your thumb and fore-finger. Lay the grease on the ring by turning it between your fingers.
The ring should have a shiny aspect with

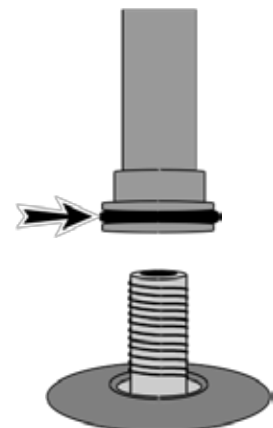

Valves installation and maintenance

Reassembly

Screw tightening torque



For a Bacosol valve:
Tighten the 4 screws diagonally.

Tightening torque is 1.5 Nm.



For a Minisol valve
Tighten the 2 screws.

Tightening torque is 0.6 Nm.

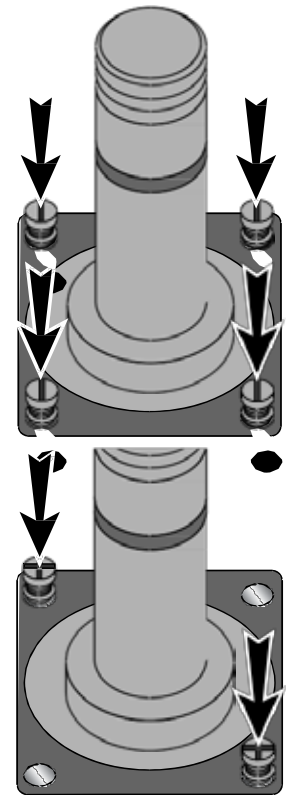

Assembly of Minisol valves
with valve block

To avoid deforming the electrovalve shaft during sizing/tightening of fittings and coil assembly: the method described must be followed .

Use a vice to handle the valve block.

Spread the glue (Loctite 542).
Install and fasten the fitting. Wipe the excess glue.

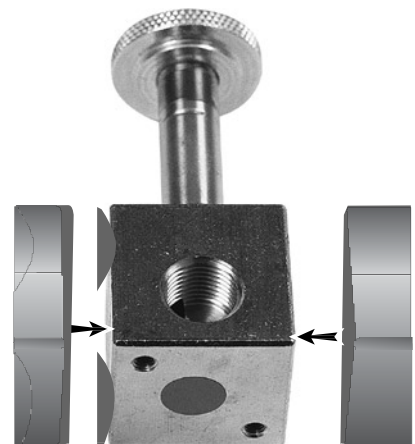

Test after installation

After the valve installation, we recommend to perform a helium leak test to check the vacuum tightness.



Take care with seal permeability. Do not expose the seals to helium for an extended time.

Exchange of the internal calibrated leak (option)

It is recommended to renew the internal calibrated leak on a regular basis in order to insure a reliable calibration of the leak detector. The alternate exchange of 2 calibrated leaks which are recalibrated in due time makes it possible. It is recommended to arrange the recalibration of the calibrated leaks within 2 years maximum.

Exchange of the internal calibrated leak

- Remove the clamps.
- Disconnect the calibrated leak.
- Insert the new calibrated leak.
- Make sure it is correctly placed.
- Make sure the leak pumping tube is correctly placed

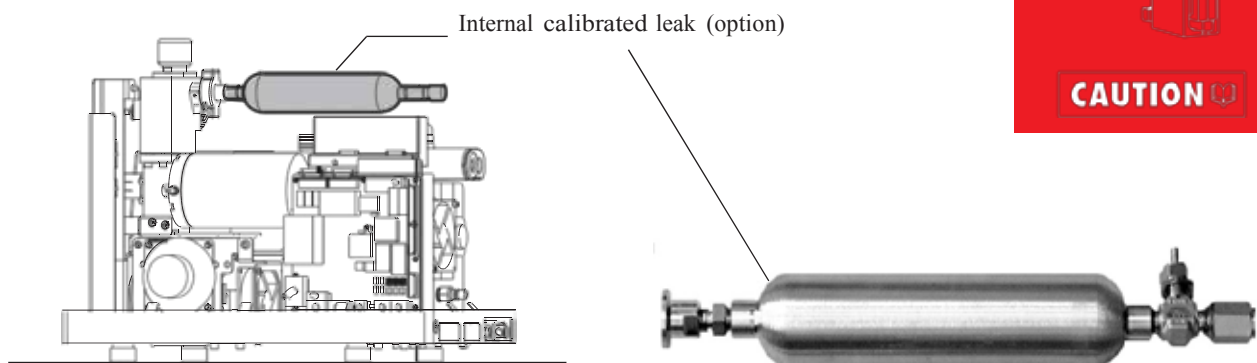
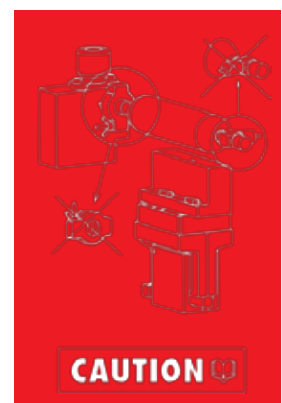

Programming the new calibrated leak characteristics

This operation can be made with the data written on the new internal calibrated leak identification label or the calibration certificate delivered with it.

 C 305

Calibrated leak supervision

A recalibration date supervision is programmed.

 D 210

Remote control

Replacement of the remote control

The operator can without difficulty exchange the remote control. The remote control delivered includes the remote control cable.



Part number  A 700

Remote control defective

2 parts of the remote control can be defective:

- the remote control box
- the remote control cable.

You should first exchange just the remote control box. If the assembly is still defective, then the cable must be exchange.

Remote control box exchange

On the defective and the new remote controls, take out the black plastic part.

On the 2 remote controls, take off the remote control cable.

Exchange the 2 remote control boxes: reconnect the old remote control cable (still connected to the leak detector) to the new remote control box and replace the black plastic part.

If after this exchange, the remote control is still defective, you should change the remote control cable.



Long distance sniffer probe and Helium spray gun

Please refer to the specific sheets for the instruction:



Long distance sniffer probe
 G 400 / G 410



Helium spray gun  G 500

Starting of the molecular and turbomolecular pumps

Restarting after stop Please wait 5 s between stop and restart, in order to be sure that the synchronism information is given to the leak detector and the display does not lock at 99 %.

If you have this problem, stop the leak detector and wait 5 s before starting again.

Starting in the cold state There is a risk that the turbomolecular pump does not start if the ball bearings temperature is below 5 °C. In order to be at the ambient temperature, 6 hours are necessary to the ball bearings.

That's why, if you start a leak detector which was outside during a cold period (in a car or in its delivery package by example), it is possible there is starting problem during 2 or 3 hours. Don't be worried ! You must just waiting that the leak detector would be at ambient temperature.

First start up after delivery We have just seen previously that the temperature has an effect on the starting of turbo pumps. The first start after delivery is even more critical as the grease stay a few days in the same position, and even is going between the balls of the bearing on the roller way in bigger quantity that expected because of the transport's vibration.

That explain some non start up of the turbomolecular pump at the first start up. In this case it is not abnormal to have to power on the leak detector several times (10 max) with 15 s between a power off and a power on, to start up the turbomolecular pump.

Greasing molecular and turbomolecular pumps

This technical sheet is for this different pumps:

ATH 164



ATP 100



TMP 5154



MDP 5011



MDP 5006 HDS



AMP 007i



The frequency of preventive maintenance is listed  D 100

Components:

Grease syringe  F 600

Disassemble the pump

It is necessary to disassemble the TMP 5154 and MDP 5006 HDS from the detector to do the greasing.

It is not necessary to disassemble the MDP 5011 from the detector to do the greasing.

Accessing the bearings

MDP 5011 / 5006 HDS / AMP 007i

Remove the clips and use the extractor to take out the plug.

Once the extractor is in place, pull it vertically.



MDP 5011

TMP 5154 / ATP 100 / ATH 164

Remove the rear cap from the pump (4 allen head screws).

This cap is directly accessible from underneath the leak detector.



TMP 5154

Greasing molecular and turbomolecular pumps

Using the grease syringe

The grease syringe is equipped with a black clip (A) and a red clip (B).

These clips are used as stops to control the amount of grease injected into the bearing.

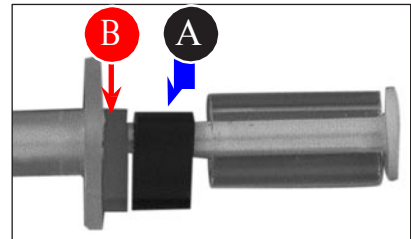

Greasing the front bearing

Push the grease syringe in through the screw hole (1) until it comes up against a stop.

Inject grease pushing in the plunger until it stops at clip B.

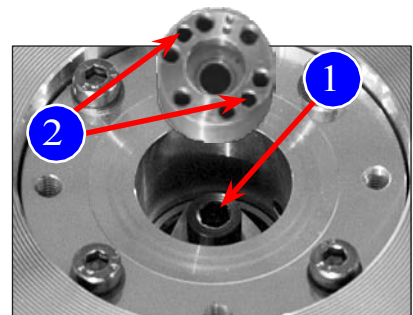

Greasing the rear bearing

Remove the red clip B and distribute the grease between the injection points (smooth holes directly opposite each other: 2).

Greasing molecular and turbomolecular pumps

«Running in» the pump after relubrication

After relubricating the pump, the grease must be distributed in the bearings (“Running in”). This is performed by limiting the speed of the pump for a short period. For this, on the P0326 converter board, set the running in switches; switch 1 to ON (detector off).

Start up the detector and let it operate for approximately 10 minutes in this position.

After 10 minutes, switch off the detector and reset switch 1 to OFF.

Start the detector up again and check that the pump reaches its synchronization speed correctly. If this time is too long, repeat the running in procedure a second time.

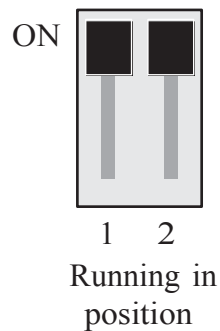

Greasing molecular and turbomolecular pumps

After relubricating, the P0326 board could not allow you to success the first or second leak detector starting. Why ? When you use a grease syringe, there is a grease accumulation on one point of the ball bearing, and so a small hard point, which will disappear progressively during the grease repartition.

What should you do ? Just after relubrication, set the pump going with your hand few minutes before to replace it (if it was removed from the leak detector) or to take off the flexible (if it was not removed from the leak detector) : in this case, try to start the pump before removing the flexible : it is not a destroying test. You can also use a turbo converter (more powerful for this first critical half turn). After you should also keep the leak detector running 2 or 3 hours before stopping it.

Adjust the
correspondance
between the different
test modes

The internal parameters allow a correspondance of the different test modes depend on the pump.
That's why after every intervention of the pump it is indispensable to for new adjustment  E 430.

Greasing molecular and turbomolecular pumps

Bearing opposite the pumping cell

Introduce the syringe equipped with its needle into the bearing and remove the red jumper.

Always position the syringe needle between two balls of the bearing so as not to damage the bearing.

Distribute the dose of grease in 2 diametrically opposed points, until the syringe plunger comes to a stop against the black jumper.



Bearing on pumping cell side

Introduce the lubrication syringe needle into the drilled screw located at the center of the rotor until it comes to a stop against the screw head.

Keep the syringe pressed down to the bottom of its housing throughout the operation.

Remove the black jumper from the syringe and introduce the grease until the plunger comes to a stop.

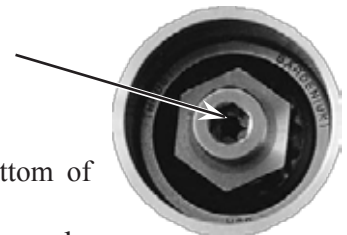

3

Remove the syringe.

Reassemble the adjustment sleeve (taking care with the direction), the spring and the end cap with its o-ring.

The relubrication operation is complete.

Execute the pump running-in.

Primary pump maintenance

The frequency of preventive maintenance is listed  D 100

Components:

ALCATEL 200 Oil (1 liter)]  F 600
Cartridge (Oil mist eliminator).....	

For best performance, check the oil level in the sight glass periodically.

Check the oil level of the roughing pump

If the level is not between the mini and the maximum level, it is necessary to add oil.

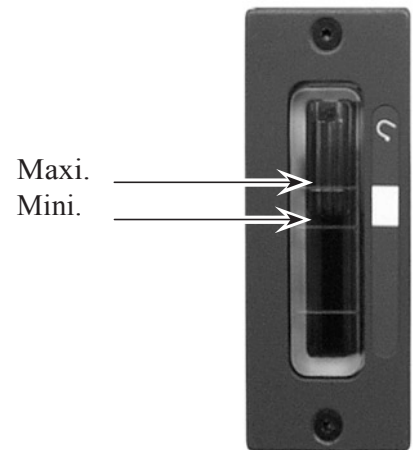

Oil for the first utilisation is delivered with the detector. ( B 110).
Replacement of oil is the user's responsibility.
The Alcatel pumps are tested with ALCATEL 200 oil.
Their specifications are guaranteed only when this recommended lubricant is used.

Add oil

- Open the cover (ASM 142).
- Remove the cover (ASM 142 S).
- Remove the draining plugs.



ASM 142 S



ASM 142

Primary pump maintenance

For oil contamination,
drain the pump

If the oil is brown, blackish or smells “burned”, it has deteriorated. In this case, drain the pump and rinse with clean oil if necessary.

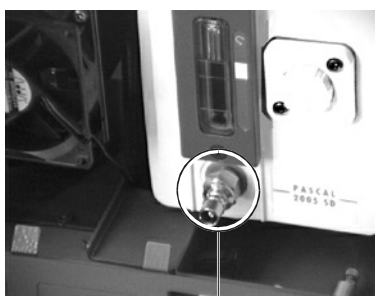

ASM 142 S

1



ASM 142

1

For dirty oil,
rinse the pump

Amount of oil required
is about 1 liter

The pump must be drained when hot and after the oil case has been vented to atmospheric pressure.

- Place a suitable receptacle under the drain.
- Connect the waste pipe (quick connector) ①
- Remove the draining plugs and collect the used oil.
- Start the rotary vane pump (start the HLD) during a short period; this for drain more rapidly.
- When the oil has drained, stop the pump.
- Disconnect the waste pipe.
- Unscrew the filler plug.
- Fill with fresh oil using a funnel.
- Replace the filler plug.

The amount of oil required to fill the pump is about 0.95 liter.

After draining the oil casing, replace the plug and run the pump at atmospheric pressure allowing fresh oil to flow slowly into the inlet port.

- Stop the pump and drain the rinsing oil.
- Replace the plug and fill with fresh oil.

Primary pump maintenance

Remove and change
the oil mist eliminator

If the cartridge is saturated:

- 1 Remove the clamping ring and the exhaust plastic pipe.
- 2 Remove the tightening screw M5.
- 3 Remove and change the oil mist eliminator and seal.

1 Exhaust plastic tube



5

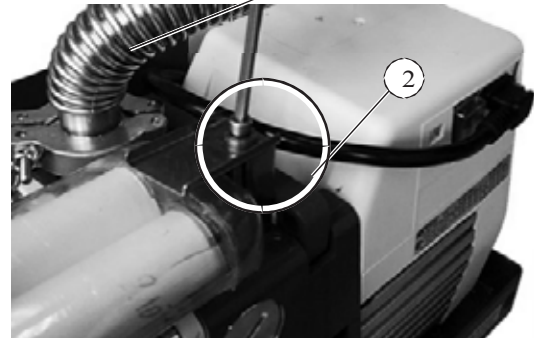

3 Oil mist eliminator and seal



Components

ASM 142 S User's Manual Detailed contents

Preliminary remarks Throughout this User's Manual, you could find this type of message "Summary of screen  C 140": it refers to a specific chapter of the User's Manual. Please read it for further information.

F 000 *Spares parts - Instructions of use*

F 001 *AVTF Customer Service Offer*

F 100 *Tools*

F 200 *Monitoring and display*

F 300 *Power and electrical supply*

F 400 *Automatic control system and electronic circuits*

F 500 *Measurement*

F 600 *Pumping*

F 700 *Valves*

F 800 *Pipes - Connections - Seals*

F 900 *Cover*

F 1000 *Options and accessories*

F 1100 *Pictures of components*

Spare parts - Instructions of use

Replacement of parts and use of non genuine parts

Our products are designed to comply with current EC regulations and guarantee optimal operating conditions with maximum safety conditions for the user.

Any modification of the product made by the user is liable to lead to non-compliance with the regulations, or even to put into doubt the performance of the product and the user's safety.

Replacement of defective components by other parts than genuine parts, and use of these parts, jeopardize the initial safety conditions of the equipment.

In such case, the EC declaration of conformity becomes null: AVTF withdraws his responsibility for such operations.

Besides, counterfeiting and unfair trading of parts are condemned under the civil and criminal laws.

AVTF urges the users no to take parts in the use of «imitations», in the misappropriation and pirating of intellectual property performed by some dishonest operators.

AVTF Customer Service Offer

AVTF Customer Service Offers for the maintenance and the reparation of your leak detector:

- new spare parts listed in the chapter F,
- the reparation of your leak detector or sub-assemblies like analyzer cell or pumps,
- standard exchange of certain sub-assemblies,
- preventive maintenances or general overhaul.

Don't hesitate to contact the Customer Service for all information complementary for these offers.



Tools



A001



A002



A006



A009



A004



Accessoires de raccordement
Connection accessories
Verbindungzubehör



Fuites calibrées Helium
Helium calibrated leaks
Helium Testleck

Ref	Description	P/N	Qty	Remarks
A001	CHC SCREW M4-80	*	1	
A002	TORQUE WRENCH (TMP)	*	1	
A003	ADAPTER, INT. CALIBRATED LEAK - 142/122D	*	1	
A004	TOOL KIT FOR AMP007I	*	1	
A006	DN16KF CALIBRATED LEAK ADAPTATOR KIT	*	1	
A007	DN25KF CALIBRATED LEAK ADAPTATOR KIT	*	1	
A009	MDP 5011EXTRACTOR	*	1	
A010	DN16KF NEEDLE VALVE	*	1	
A011	TEE, REDUCING - DN40/40/16KF	303358	1	
A012	TEE, REDUCING - DN50/50/16KF	303359	1	
A013	TEE, REDUCING - DN25/25/16KF	068269	1	
A014	CALIB. LEAK WITH VALVE 1-3.10-6 DN40KF	FV4620	1	
A015	CALIB. LEAK WITH VALVE 1-3.10-6 DN50KF	FV4630	1	
A016	CALIB. LEAK WITH VALVE 1-3.10-6 DN25KF	FV4610	1	
A017	CLAMP DN10/16KF	083333	1	
A018	CLAMP DN32/40KF	083267	1	
A019	CLAMP DN50KF	087163	1	
A020	CLAMP DN20/25KF	083264	1	
A021	CENTERING RING SS/PER DN16KF	068193	1	
A022	CENTERING RING SS/PER DN40KF	068194	1	
A023	CENTERING RING SS/PER DN50KF	087164	1	
A024	CENTERING RING SS/PER DN25KF	068189	1	
A025	FUNNEL	067592	1	

* contact customer services

Tools - ASM 142 S



A001



A002



A006



A009



A004



Accessoires de raccordement
Connection accessories
Verbindungzubehör



Fuites calibrées Helium
Helium calibrated leaks
Helium Testleck

Ref	Description	P/N	Qty	Remarks
A026	VACUUM GREASE (TUBE OF 10 G)	105290	1	
A027	VACUUM SILICON GREASE (100 G BOX)	064600	1	
A028	MOLD FOR LEAD SEAL	072427	1	
A029	HOUSING KIT INSERTABLE - ATH20/30/40	*	1	
A030	CELL, ANALYZER ; PACKAGING	*	1	
A031	TEST CHAMBER ADAPTER; DN40KF	067791	1	
A032	CYCLE COMMAND FOOT PEDAL	100913	1	
A034	DETECTOR/TOUCH SCREEN PANEL SERIAL CABLE	A461946	1	
A035	DETECTOR PACKAGING - 142	111930	1	

* contact customer services

Tools - ASM 142 S

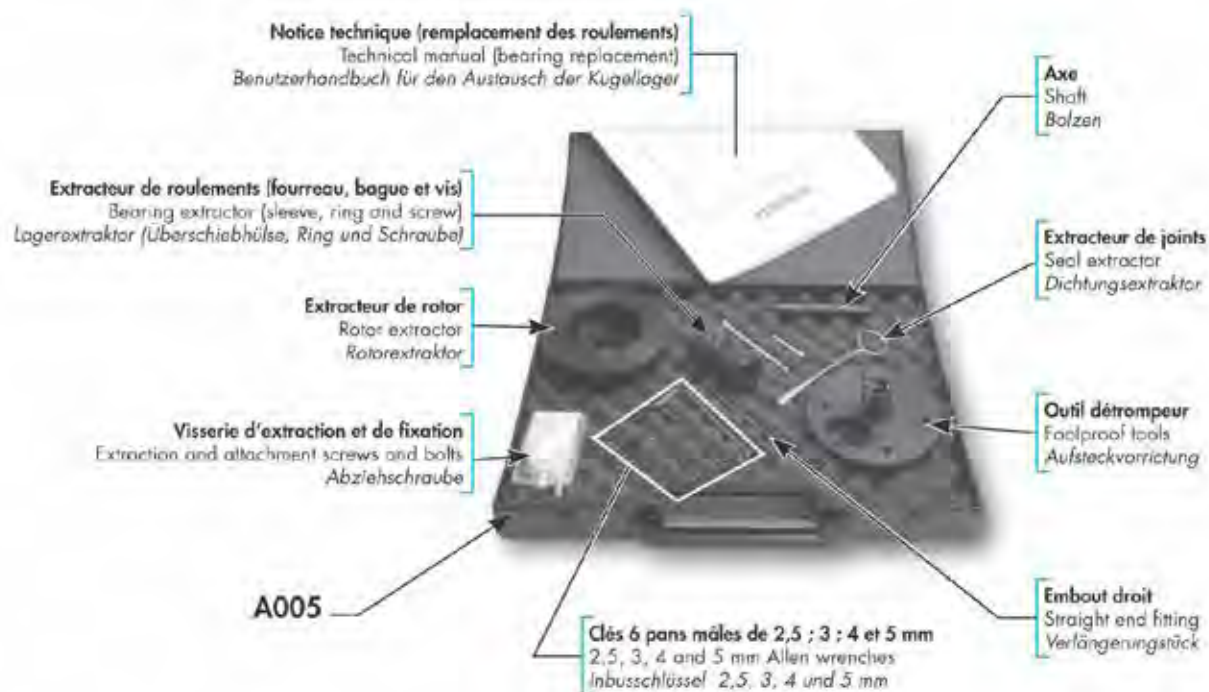

Ref	Description	P/N	Qty	Remarks
A005	TOOL KIT FOR MDP5011/ATS100	*	1	

* contact customer services

Tools

Rep. Ref. / Teil	Qty. / Menge	Description / Designation / Beschreibung	Rep. Ref. / Teil	Qty. / Menge	Description / Designation / Beschreibung
1	4	Vis CHc M 3x6 Screw CHc M 3x6 Innensechskantschraube CHc M 3x6	9	3	Rondelle Washer Unterlegscheibe
2	4	Rondelle Washer Unterlegscheibe	10	1	Fusible 5 x 20 F1 6,3 A Fuse 5 x 20 F1 6,3 A Sicherung 5 x 20 F1 6,3 A
3	8	Vis CS 2x4 Screw CS 2x4 Edelstahlschraube CS 2x4	11	1	Fusible 5 x 20 F1 3,15 A Fuse 5 x 20 F1 3,15 A Sicherung 5 x 20 F1 3,15 A
4	16	Rondelle Washer Unterlegscheibe	12	1	Fusible 5 x 20 F1 1,25 A Fuse 5 x 20 F1 1,25 A Sicherung 5 x 20 F1 1,25 A
5	2	Vis CS 2x7,6 Screw CS 2x7,6 Edelstahlschraube CS 2x7,6	13	1	Fusible 5 x 20 F1 2 A Fuse 5 x 20 F1 2 A Sicherung 5 x 20 F1 2 A
6	1	Collecteur d'électron double Double electron collector Zweifach-Elektronenkollektor	14	1	Clé six pans mâle de 5 mm à 5 Allen wrench Innensechskantschlüssel 5 mm
7	1	Vis CHc M 4x80 Screw CHc M 4x80 Innensechskantschraube CHc M 4x80	15	1	Clé six pans mâle de 2,5 mm à 2,5 Allen wrench Innensechskantschlüssel 2,5 mm
8	3	Vis CHc M 6x30 Screw CHc M 6x30 Innensechskantschraube CHc M 6x30	16	1	Tournevis 2 x 40 Screwdriver 2 x 40 Richtschraubendreher 2 x 40

Ref	Description	P/N	Qty	Remarks
A033	DETECTION MAINTENANCE KIT	111465	1	

* contact customer services

Monitoring and display

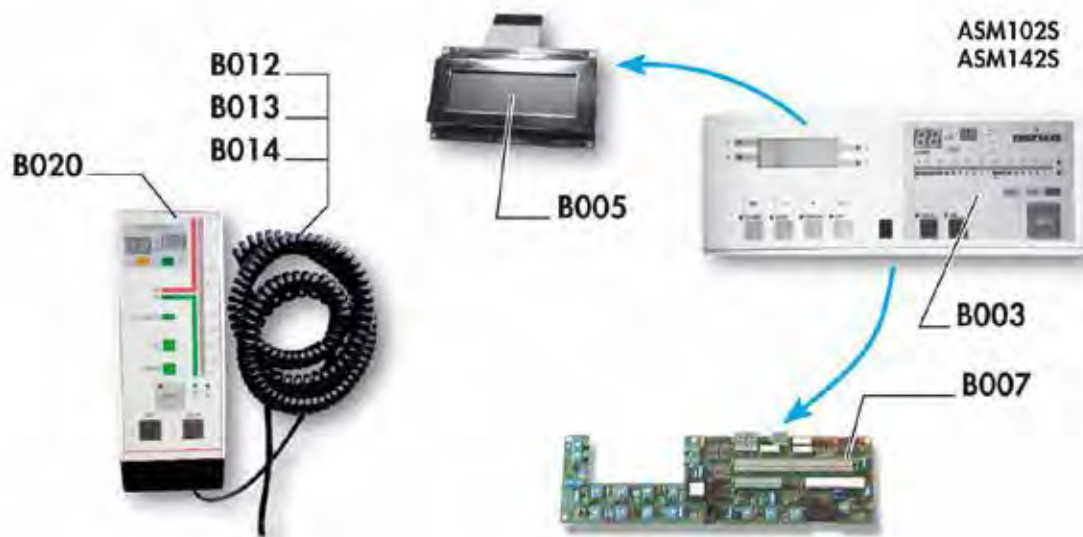

Ref	Description	P/N	Qty	Remarks
B003	CONTROL PANEL EUR/US - 102S/142S	A459706	1	
B005	LCD DISPLAY + WIRING HARNESS - 142/182	*	1	
B007	P0335E1 CONTROL PANEL BOARD - 142/182	*	1	
B012	CABLE FOR REMOTE CONTROL 2G, 5 M	A458735	1	
B013	CABLE FOR REMOTE CONTROL 2G, 10 M	110881	1	
B014	CABLE FOR REMOTE CONTROL 2G, 15 M	110882	1	
B020	REMOTE CONTROL LDS - MBAR.L/S	112747	1	

* contact customer services

Power and electrical supply

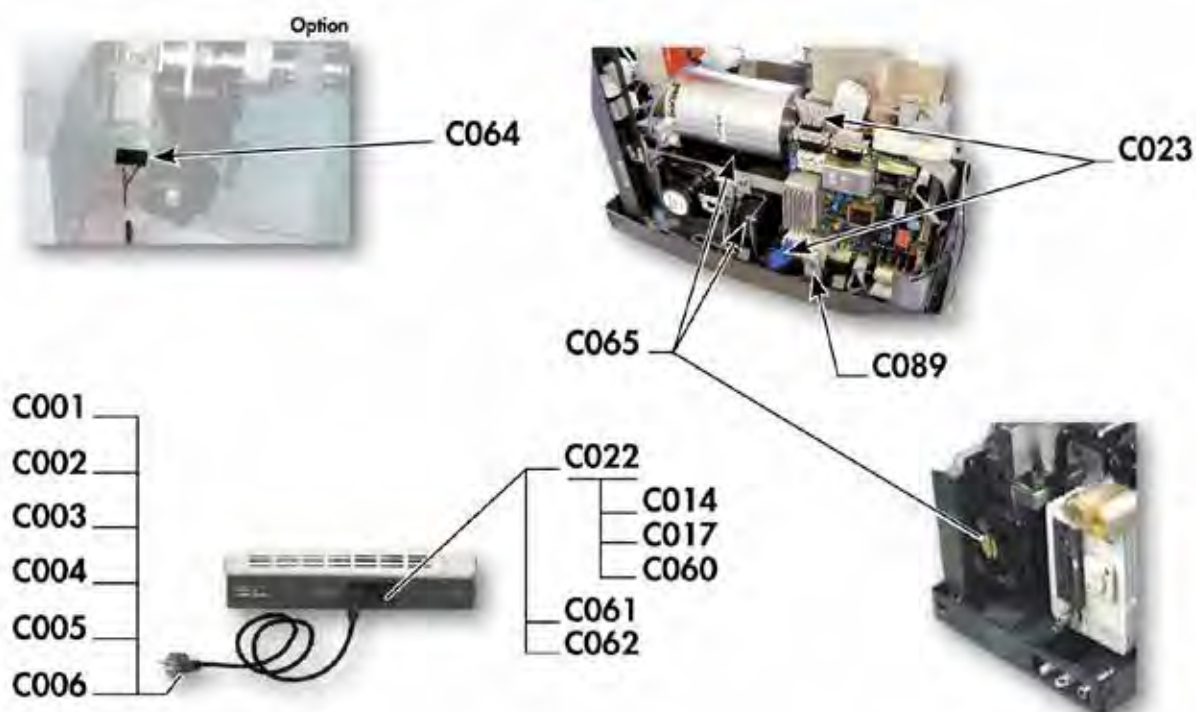

Ref	Description	P/N	Qty	Remarks
C001	CABLE, MAIN POWER; 2 M - WITHOUT PLUG	104559	1	
C002	CABLE, MAIN POWER; 2 M - ITALY	104758	1	
C003	CABLE, MAIN POWER; 2 M - SWITZERLAND	103718	1	
C004	CABLE, MAIN POWER; 2 M - UK	104411	1	
C005	CABLE, MAIN POWER; 2 M - US	103567	1	
C006	CABLE, MAIN POWER; 2 M - FRANCE/GERMANY	103566	1	
C014	FUSE 5X20 TEMP. 6.3 A	060860	1	142D:s/n<45055 142S:s/n<50140 142:s/n<41404
C017	FUSE 5X20 TEMP. 16 A	*	1	142D:s/n<45055 142S:s/n<50140 142:s/n<41404
C022	PLUG, MAIN POWER	106747	1	
C023	HARNESS, BASIC WIRING - 142	*	1	
C060	FUSE 5X20 TEMP. (+) 5 A	107650	1	142D:s/n<45055 142S:s/n<50140 142:s/n<41404
C061	CIRCUIT BREAKER 16 A 115 V - 142	111280	1	142D:s/n>=45055 142S:s/n>= 50140 142:s/n>=41404
C062	CIRCUIT BREAKER 8 A 230 V - 142	111281	1	142D:s/n>=45055 142S:s/n>= 50140 142:s/n>=41404
C064	HARNESS, CALIBRATED LEAK WIRING	*	1	
C065	FAN - 142/102S/122D	A459291	1	
C089	HARNESS, SPECIFIC WIRING - 142S	*	1	

* contact customer services

Power and electrical supply

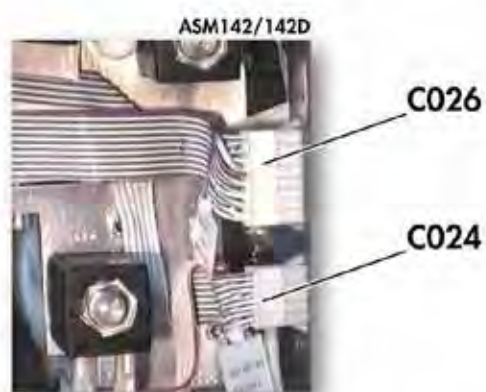
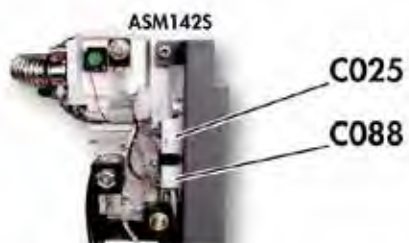

Ref	Description	P/N	Qty	Remarks
C025	HARNESS, 9 PTS BLOCK - 142S	*	1	
C026	HARNESS, 15 PTS BLOCK - 142	*	1	
C027	HARNESS, 34 PTS RS232 WIRING - 142/102S	*	1	
C028	HARNESS, 26 PTS RS232 WIRING - 142/102S	*	1	
C088	HARNESS, BLOCK FAN - 142S	*	1	

* contact customer services

Automatic control system and electronic circuits

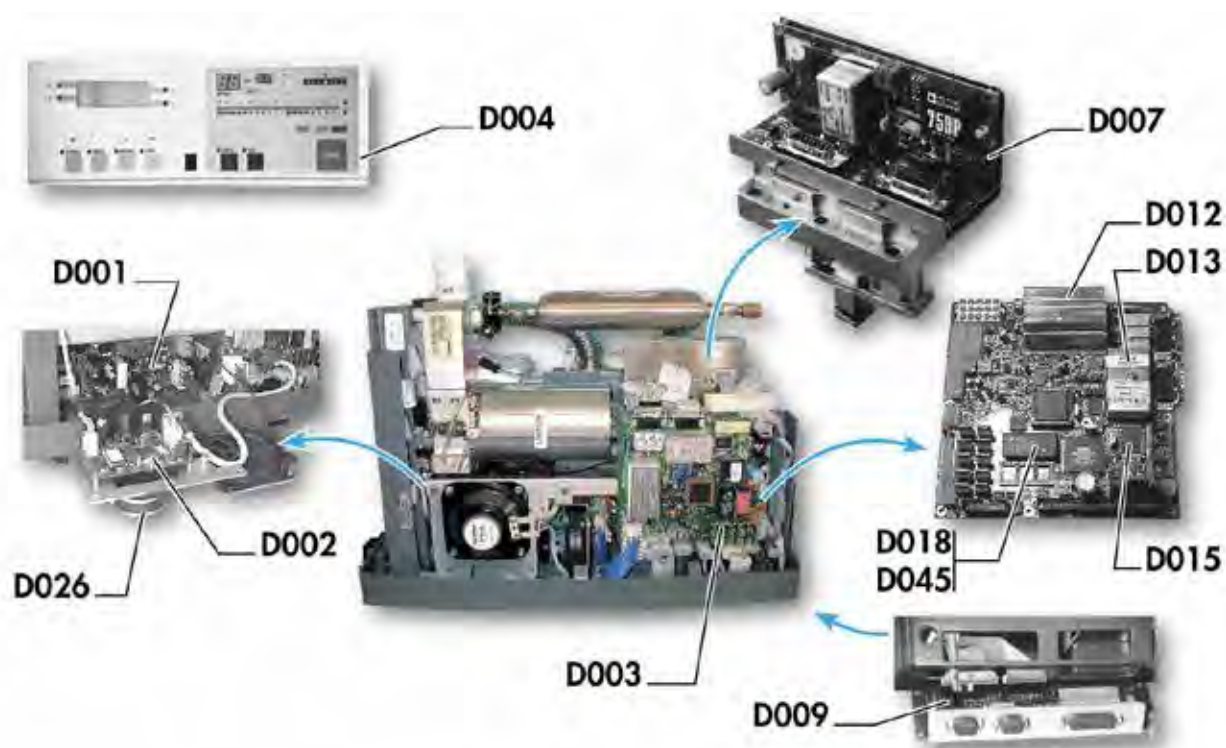

Ref	Description	P/N	Qty	Remarks
D001	P0330E1 POWER SUPPLY BOARD - 142/182	*	1	
D003	P0302E6S MAIN BOARD 122/142/182/192/1002	*	1	
D004	P0335E1 CONTROL PANEL BOARD - 142/182	*	1	
D007	P0320E1 CELL 2G.1 MAIN BOARD	*	1	
D009	P0307E1 INTERFACE BOARD - 102S/142/122D	*	1	
D012	FILAMENT POWER SUPPLY - P0302	*	1	Used for P0302-P0193-P0316-P0200
D013	POWER SUPPLY MODULE - P0302	*	1	
D015	EPROM, VOICE SYNTHESIS - 142S	*	1	
D018	SOFTWARE EPROM - 142S	*	1	
D026	LOUDSPEAKER; 90 DB/D 10 CM	060097	1	
D045	SOFTWARE EPROM - 142S	*	1	

* contact customer services

Measurement

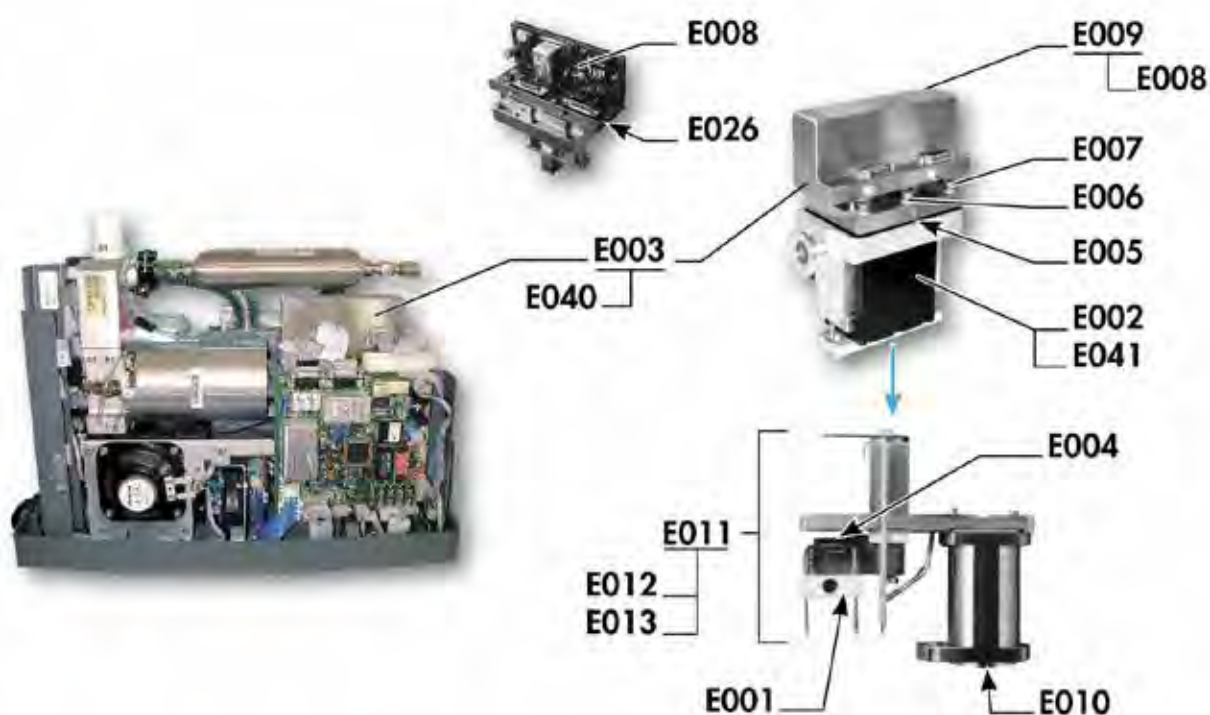

Ref	Description	P/N	Qty	Remarks
E001	FILAMENT ASSEMBLY FOR ANALYZER CELL	053146	1	
E002	MAGNET 1 MASS - ANALYSIS CELL	*	1	
E003	CELL 2G.1; STD PRESET - 142/182/192/20MD	*	1	
E004	ELECTRON COLLECTOR, DOUBLE	101127	1	
E005	SEAL, ELASTOMER; SPECIAL CELL	102823	1	
E006	SPECIAL WASHER FOR ANALYZER CELL	083486	1	
E007	CHC SCREW M6-35	075612	1	
E008	P0320E1 CELL 2G.1 MAIN BOARD	*	1	
E009	CELL, ANALYZER 2G1; EQUIPPED COVER	*	1	
E010	CELL, 2G.1; PREAMP. TARGET ASSEMBLY	*	1	
E011	CELL, 2G.1; ELECT. DEFLECTION ASSEMBLY	*	1	
E012	CELL, ANALYZER 2G.1; ACCESSORIES KIT	*	1	
E013	COLLECTOR + FILAMENT KIT - 2G.1 CELL	A459843	1	
E026	FILAMENT FOR PI1 GAUGE	*	1	
E040	CELL, ANALYZER ; PACKAGING	*	1	

* contact customer services

Measurement



Ref	Description	P/N	Qty	Remarks
E021	P0203E1 CAL. LEAK TEMPERATURE SENSOR	*	1	
E022	HARNESS, CALIBRATED LEAK WIRING	*	1	
E023	CALIBRATED LEAK, INTERNAL - 142S/OPTION	108111	1	
E038	SHOCK ABSORBER - C	076112	1	

* contact customer services

Pumping

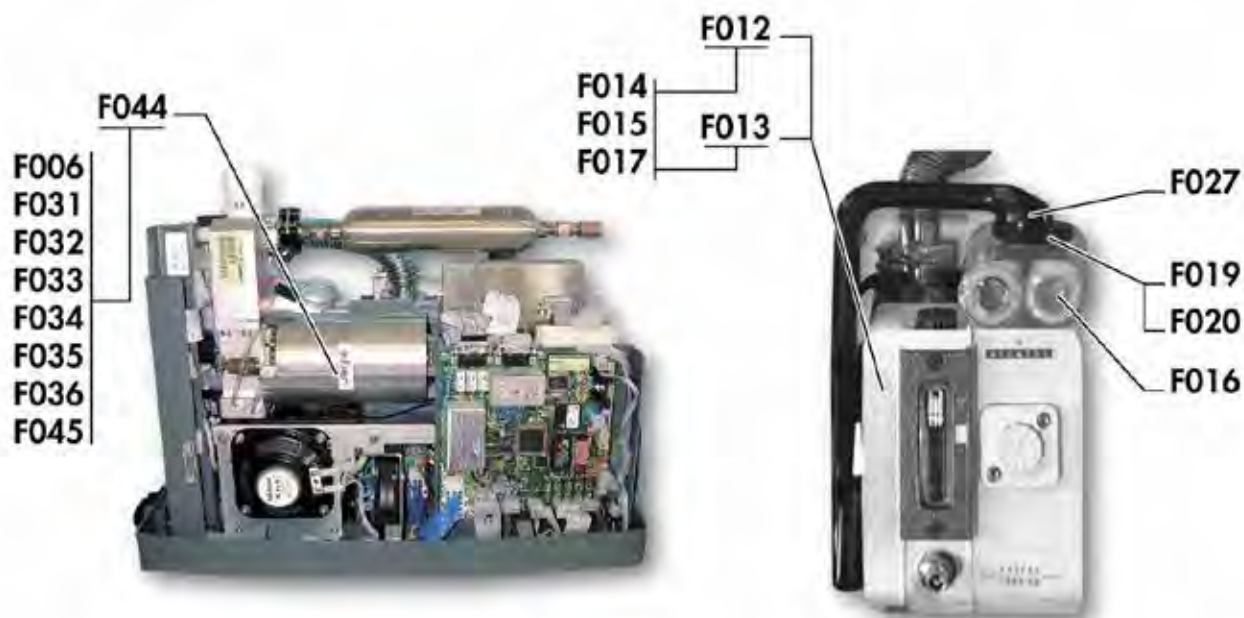

Ref	Description	P/N	Qty	Remarks
F006	GREASE SYRINGE FOR MDP/TMP	056993	1	
F012	RVP UM 2005 SD LV A200 (Y) SCE (SERVICE)	205SFYLLS	1	
F013	RVP UM 2005 SD HV A200 (Y) SCE (SERVICE)	205SFYHLS	1	
F014	OIL, ALCATEL 200 (1L)	068694	1	
F015	FUNNEL	067592	1	
F016	OIL MIST ELIMINATOR; 21 M3/H D 30 MM	107348	1	
F017	QUICK FEMALE CONNECTOR D 12 MM RMI09	107646	1	
F019	CLAMP, TUBE PRESS; 35.0/38.5 MM	107645	1	
F020	CLAMP, TUBE PRESS; 12.8/15.0 MM	107648	1	
F027	HOSE, FLEXIBLE EXHAUST - 142	A328645	1	
F031	CERAMIC BEARING KIT 8.000 TMP	*	1	
F032	CERAMIC BEARING KIT 7.999/8.000 TMP	*	1	
F033	CERAMIC BEARING KIT 7.998/7.999 TMP	*	1	
F034	CERAMIC BEARING KIT 7.997/7.998 TMP	*	1	
F035	CERAMIC BEARING KIT 7.996/7.997 TMP	*	1	
F036	TOOL KIT FOR MDP5011/ATS100	*	1	
F044	AMP007I - SERVICE	N1B602	1	
F045	SEALS KIT, PERBUNAN - AMP007I	*	1	
F080	TOOL KIT FOR AMP007I	*	1	

* contact customer services

Valves

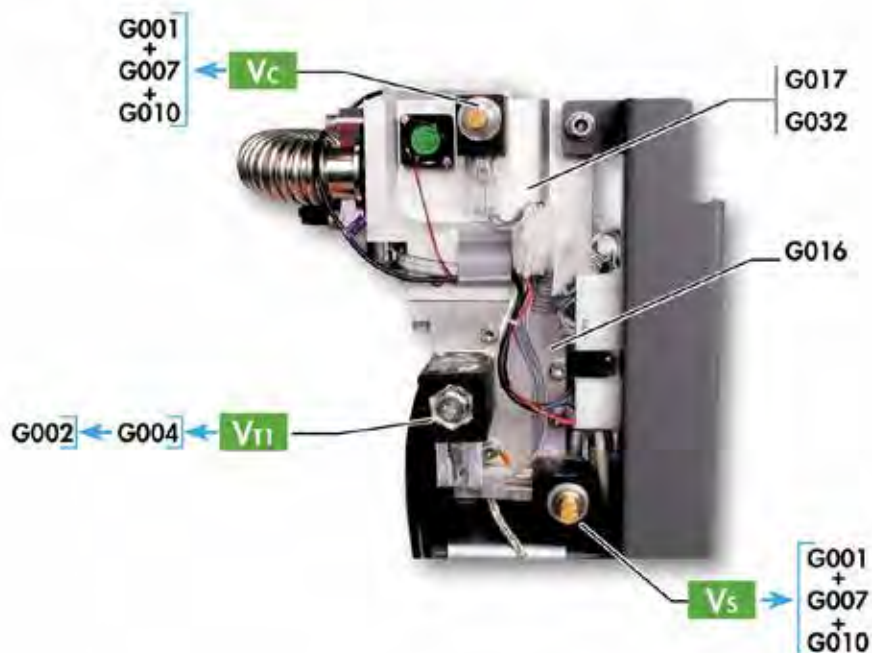

Ref	Description	P/N	Qty	Remarks
G001	MINISOL VALVE COIL 24 V	067040	1	
G002	COIL 24 VDC 23 W	*	1	
G004	VALVE KIT, NC BACOSOL (104655)	106935	1	
G007	VALVE, MINISOL; 3/2 NF 24 VDC/8 W	106009	1	
G012	VACUUM SILICON GREASE (100 G BOX)	064600	1	
G016	VALVE BLOCK, LOWER - 142/142D/142S	*	1	
G017	VALVE BLOCK, UPPER - 142S	*	1	
G029	SHOCK ABSORBER - C	076112	1	
G032	VALVE BLOCK, UPPER - 142S	*	1	

* contact customer services

Pipes - Connections - Seals



Ref	Description	P/N	Qty	Remarks
H001	TUBING, PVC; D 4 x 1 MM	*	1	
H005	CONNECTOR FOR PLASTIC TUBE 4 x 1	A458324	1	
H006	BODY FEMALE CONNECTOR G 1/8 RBE03.2100	082988	1	
H007	BELLOWS, SS; DN25KF L 250 MM	068370	1	
H020	CLAMP DN10/16KF	083333	1	
H026	CLAMP DN20/25KF	083264	1	
H028	CLAMP DN32/40KF	083267	1	
H030	CLAMP DN50KF	087163	1	
H035	MALE UNION BSPT F3BPL 2.7/4 - 1/8	082775	1	
H037	O'RING DN25KF HNBR	106022	1	
H040	O'RING DN16KF HNBR	106021	1	
H046	DIAPHRAGM DN25KF - D 10 MM	100983	1	
H047	CENTERING RING DN25KF	068224	1	
H050	FILTER, DN25KF; 70 MICRONS	072857	1	
H074	SEAL, ELASTOMER; SPECIAL CELL	102823	1	
H087	TEE, REDUCING - DN40/40/16KF	303358	1	
H088	TEE, REDUCING - DN50/50/16KF	303359	1	
H089	TEE, REDUCING - DN25/25/16KF	068269	1	
H090	CENTERING RING SS/PER DN16KF	068193	1	
H091	CENTERING RING SS/PER DN40KF	068194	1	
H092	CENTERING RING SS/PER DN50KF	087164	1	
H093	CENTERING RING SS/PER DN25KF	068189	1	
H097	QUICK FEMALE CONNECTOR D 12 MM RMI09	107646	1	

* contact customer services

Pipes - Connections - Seals



Ref	Description	P/N	Qty	Remarks
H098	CLAMP, TUBE PRESS; 35.0/38.5 MM	107645	1	
H099	CLAMP, TUBE PRESS; 12.8/15.0 MM	107648	1	
H105	SEALS KIT, PERBUNAN - AMP007I	*	1	
H113	MALE CONNECTOR 4/6 MM - 1/8 BSPT	083391	1	
H114	FEMALE CONNECTOR 1/8 BSPT - LDS TUBE	067843	1	
H115	O'RING DN16KF NBR	079237	1	
H124	O'RING 1.78 x 12.42 NBR	082152	1	
H125	MALE PURGE FITTING (BHU 22-06 CPC)	107641	1	

* contact customer services

Cover

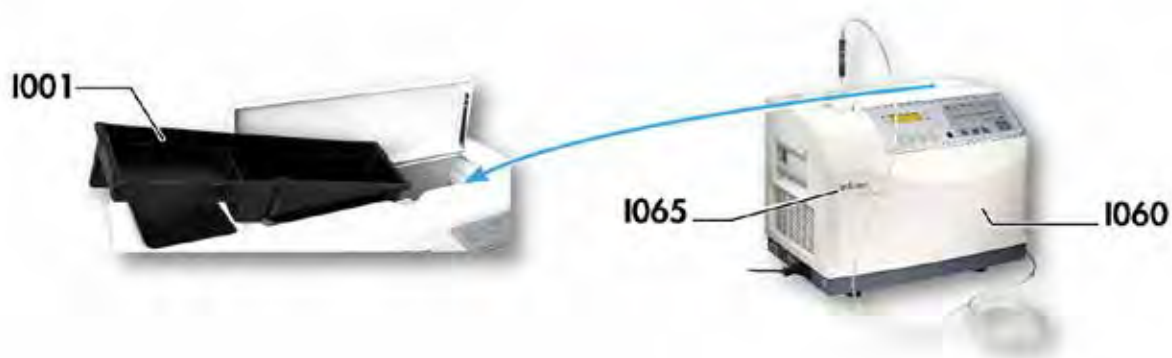

Ref	Description	P/N	Qty	Remarks
I001	CONTAINER - 142	A212639	1	
I059	DETECTOR PACKAGING - 142	111930	1	
I044	FOOT - 142	A459023	1	
I060	COVER, WITHOUT LOGO - 142	A462454	1	
I065	LOGO - 142S	A462516	1	

* contact customer services

Options and accessories

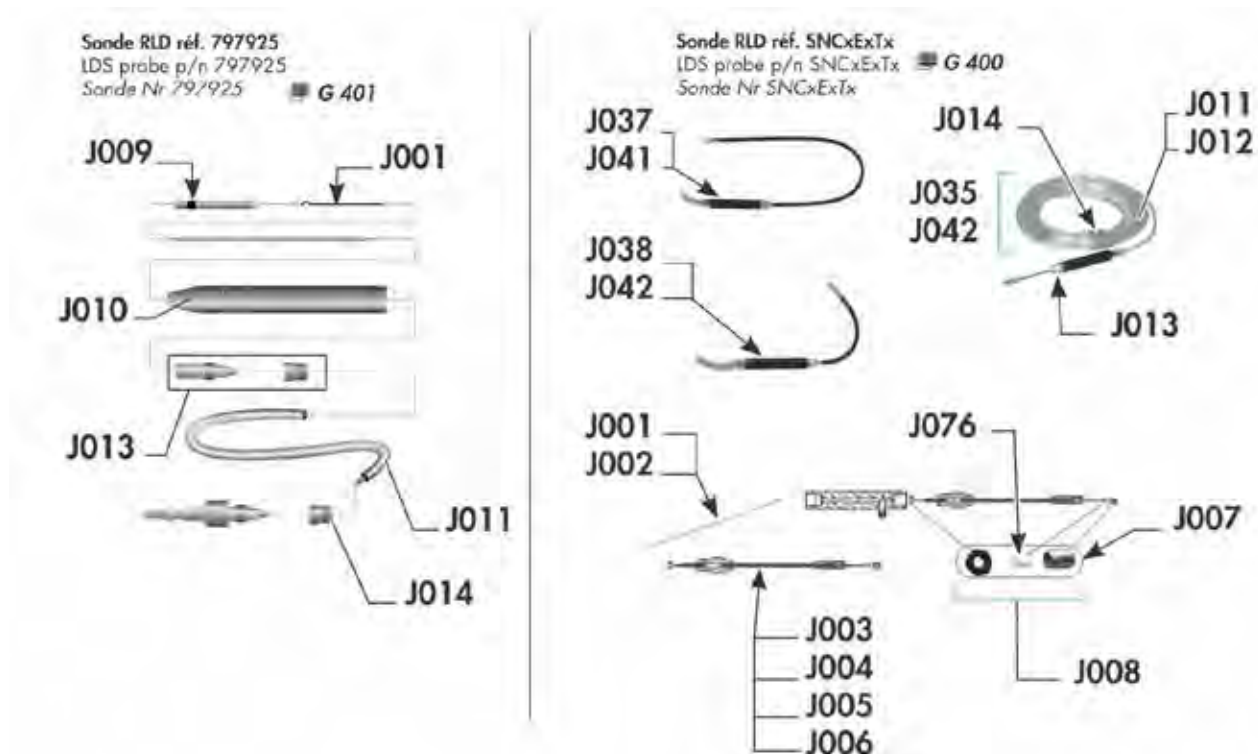

Ref	Description	P/N	Qty	Remarks
J001	NEEDLE FOR LDS PROBE - D 0.3 MM	072606	1	
J002	NEEDLE FOR LDS PROBE - D 0.35 MM	A461716	1	
J003	NOZZLE, SHORT RIGID - 2000 LD SNIFFER	108242S	1	
J004	NOZZLE, LONG; FOR HE PROBE	108243S	1	
J005	NOZZLE, SHORT FLEXIBLE - 2000 LD SNIFFER	108883S	1	
J006	NOZZLE, LONG FLEXIBLE - 2000 LD SNIFFER	108884S	1	
J007	HC SCREW M5-6 - 2000 LD SNIFFER	A459725	1	
J008	5 FILTERS/2 SCREWS/2 O'RINGS - LDS PROBE	A459858	1	
J009	FILTER, IN TUBING - LDS PROBE	*	1	
J010	TUBE FOR LDS PROBE (OM)	067838	1	
J011	TUBING, LDS - 5 METERS	072300	1	
J012	TUBING, LDS - 10 METERS	A459882	1	
J013	MALE CONNECTOR 4/6 MM - 1/8 BSPT	083391	1	
J014	FEMALE CONNECTOR 1/8 BSPT - LDS TUBE	067843	1	
J034	10 M EXTENSION - LDS PROBE	090216	1	
J035	SNIFFER CANA.5 S R9 NIPPLE PENCIL	SNC1E1T1	1	
J036	SNIFFER CANA.5 S R30 NIPPLE PENCIL	SNC1E2T1	1	
J037	SNIFFER CANA.5 S S15 NIPPLE PENCIL	SNC1E3T1	1	
J038	SNIFFER CANA.5 S S45 NIPPLE PENCIL	SNC1E4T1	1	
J039	SNIFFER CANA.10 S R9 NIPPLE PENCIL	SNC2E1T1	1	
J040	SNIFFER CANA.10 S R30 NIPPLE PENCIL	SNC2E2T1	1	
J041	SNIFFER CANA.10 S S15 NIPPLE PENCIL	SNC2E3T1	1	
J042	SNIFFER CANA.10 S S45 NIPPLE PENCIL	SNC2E4T1	1	

* contact customer services

Options and accessories

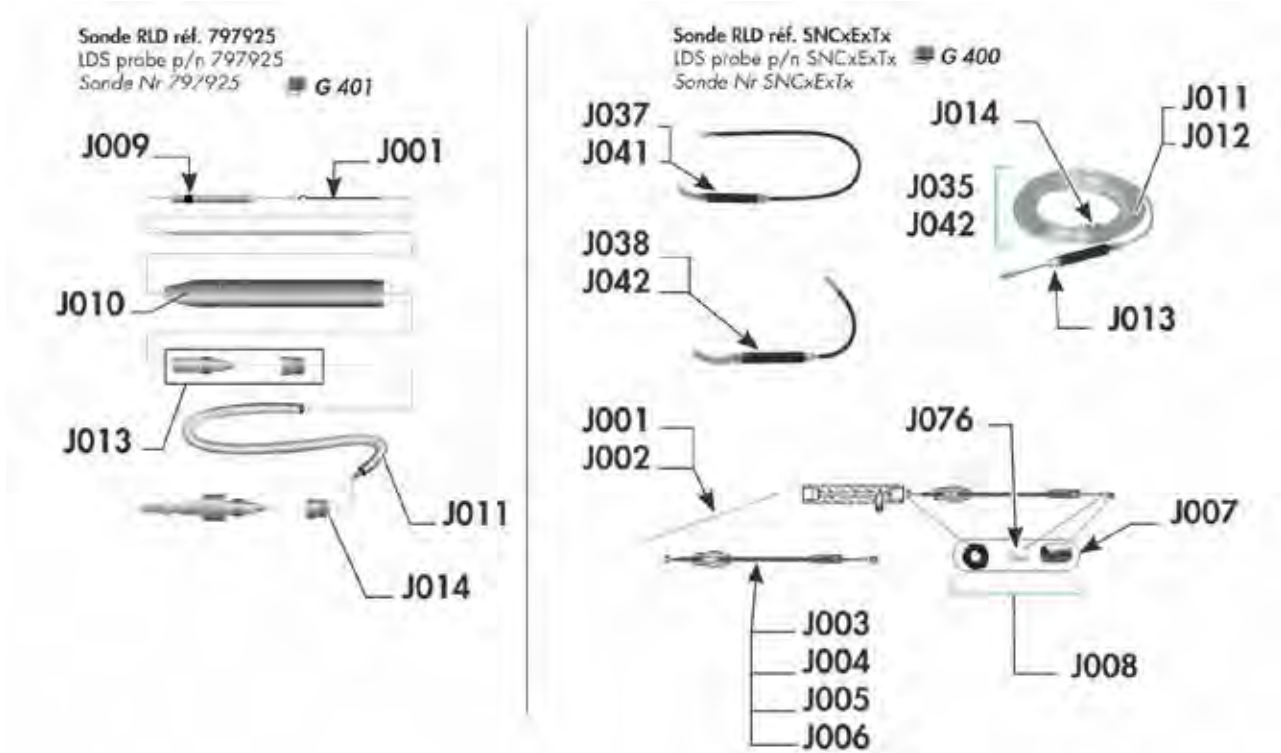

Ref	Description	P/N	Qty	Remarks
J076	SNIFFER FILTER STONE	067722	1	

* contact customer services

Options and accessories

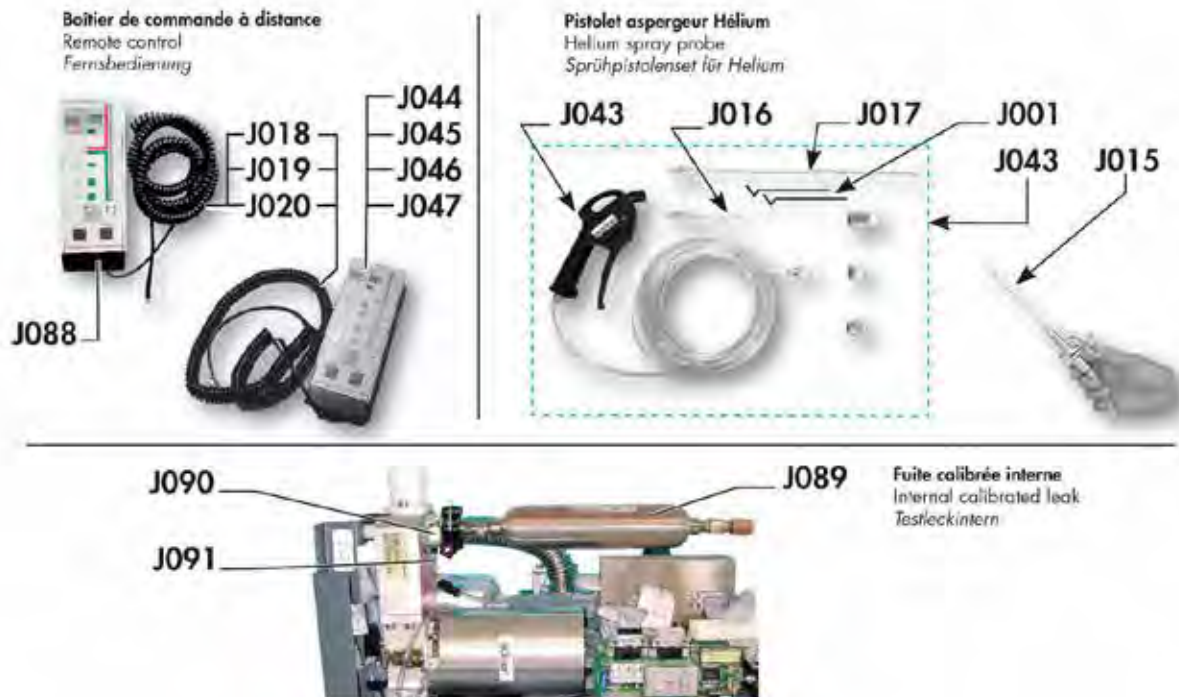

Ref	Description	P/N	Qty	Remarks
J015	TUBE HE SPRAY PROBE (OLD MODEL)	083446	1	
J016	NOZZLE, SHORT RIGID; FOR HE PROBE	109955	1	
J017	NOZZLE, LONG RIGID; FOR HE PROBE	109956	1	
J018	CABLE FOR REMOTE CONTROL 2G, 5 M	A458735	1	
J019	CABLE FOR REMOTE CONTROL 2G, 10 M	110881	1	
J020	CABLE FOR REMOTE CONTROL 2G, 15 M	110882	1	
J043	HELIUM SPRAY PROBE	109951	1	
J088	REMOTE CONTROL LDS - MBAR.L/S	112747	1	
J089	CALIBRATED LEAK, INTERNAL - 142S/OPTION	108111	1	
J090	P0203E1 CAL. LEAK TEMPERATURE SENSOR	*	1	
J091	HARNESS, CALIBRATED LEAK WIRING	*	1	

* contact customer services

Options and accessories

Option joints metal
Metal seals option
Metalldichtung Option



J049 J054
J050 J055
J051 J056
J052 J057
J053 J058

Ref	Description	P/N	Qty	Remarks
J048	CELL 2G.1; MET PRESET - 142/182/192/20MD	*	1	
J080	LEAD WIRE 10 M - 0.8 MM	083478	1	

* contact customer services

Options and accessories

Option RS232
RS232 option
RS232 Option



Option 3 masses
3 masses option
3 Massen Option

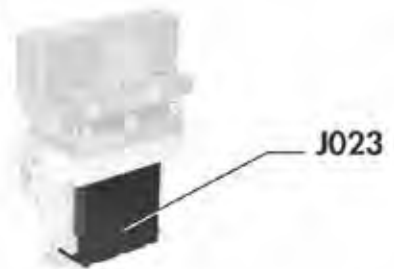

Option entrée DN 40
DN 40 inlet option
DN 40 Eingang Option

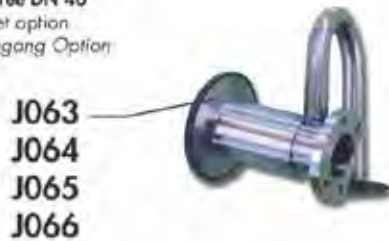

Filtres d'entrée
Inlet filters
Eingang Filters



Ref	Description	P/N	Qty	Remarks
J059	INTERFACE KIT - 142	107657	1	
J060	P0307E1 INTERFACE BOARD - 102S/142/122D	*	1	
J061	HARNESS, 34 PTS RS232 WIRING - 142/102S	*	1	
J062	HARNESS, 26 PTS RS232 WIRING - 142/102S	*	1	
J074	MAINTENANCE KIT FOR PRINTER	100807	1	

* contact customer services

Pictures of components

F 100 Tools



* A001
CHC SCREW M4-80



* A002
TORQUE WRENCH (TMP)



* A003
ADAPTER, INT. CALIBRATED LEAK -
T42/T22D

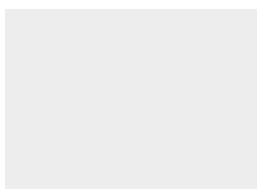

* A004
TOOL KIT FOR AMP007I



* A005
TOOL KIT FOR MDP5011/ATS100



* A006
DN16KF CALIBRATED LEAK
ADAPTATOR KIT



* A007
DN25KF CALIBRATED LEAK
ADAPTATOR KIT



* A009
MDP 5011EXTRACTOR



* A010
DN16KF NEEDLE VALVE

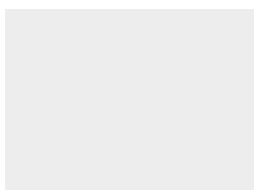

303358 A011
TEE, REDUCING - DN40/40/16KF

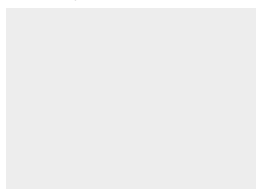

303359 A012
TEE, REDUCING - DN50/50/16KF

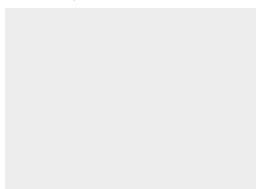

068269 A013
TEE, REDUCING - DN25/25/16KF

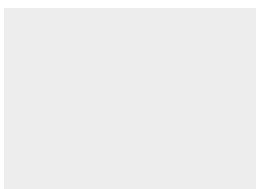

FV4620 A014
CALIB. LEAK WITH VALVE 1-3.10-6
DN40KF

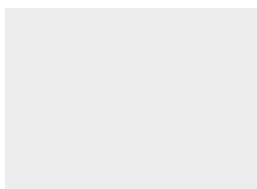

FV4630 A015
CALIB. LEAK WITH VALVE 1-3.10-6
DN50KF

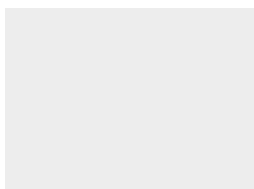

FV4610 A016
CALIB. LEAK WITH VALVE 1-3.10-6
DN25KF

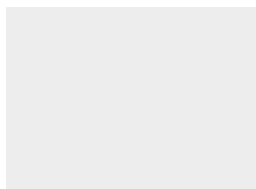

083333 A017
CLAMP DN10/16KF



083267 A018
CLAMP DN32/40KF

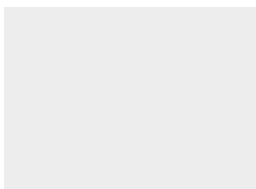

087163 A019
CLAMP DN50KF



083264 A020
CLAMP DN20/25KF

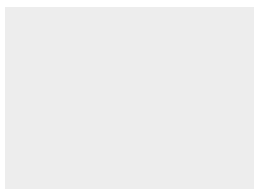

068193 A021
CENTERING RING SS/PER DN16KF

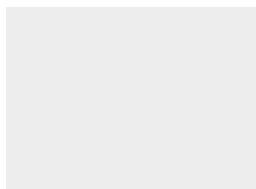

068194 A022
CENTERING RING SS/PER DN40KF

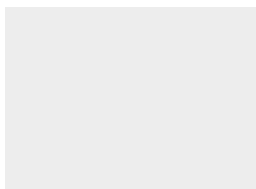

087164 A023
CENTERING RING SS/PER DN50KF

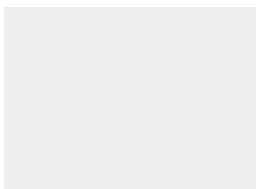

068189 A024
CENTERING RING SS/PER DN25KF



067592 A025
FUNNEL

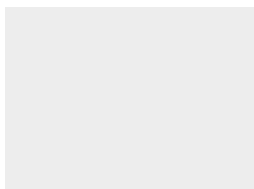

105290 A026
VACUUM GREASE (TUBE OF 10 G)



064600 A027
VACUUM SILICON GREASE (100 G
BOX)



072427 A028
MOLD FOR LEAD SEAL

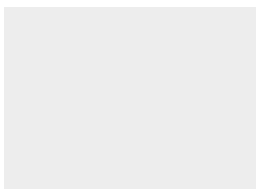

* A029
HOUSING KIT INSERTABLE -
ATH20/30/40

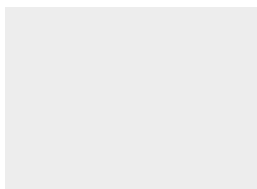

* A030
CELL, ANALYZER : PACKAGING

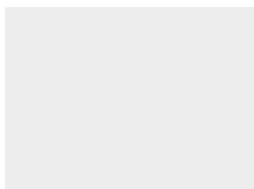

067791 A031
TEST CHAMBER ADAPTER: DN40KF

Pictures of components



100913 A032
CYCLE COMMAND FOOT PEDAL



111465 A033
DETECTION MAINTENANCE KIT

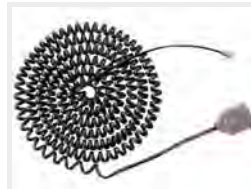

A461946 A034
DETECTOR/TOUCH SCREEN PANEL
SERIAL CABLE

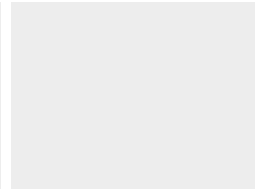

111930 A035
DETECTOR PACKAGING - 142

F 200 Monitoring and display



A459706 B003
CONTROL PANEL EUR/US - 102S/142S



* B005
LCD DISPLAY + WIRING HARNESS -
142/182



* B007
P0335E1 CONTROL PANEL BOARD -
142/182



A458735 B012
CABLE FOR REMOTE CONTROL 2G, 5
M

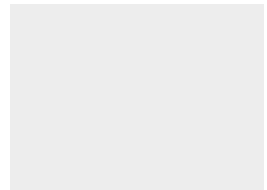

110881 B013
CABLE FOR REMOTE CONTROL 2G, 10
M

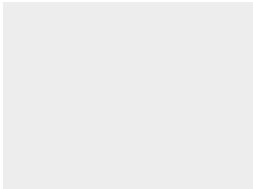

110882 B014
CABLE FOR REMOTE CONTROL 2G, 15
M



112747 B020
REMOTE CONTROL LDS - MBAR.L/S

F 300 Power and electrical supply



104559 C001
CABLE, MAIN POWER: 2 M - WITHOUT
PLUG



104758 C002
CABLE, MAIN POWER: 2 M - ITALY



103718 C003
CABLE, MAIN POWER: 2 M -
SWITZERLAND



104411 C004
CABLE, MAIN POWER: 2 M - UK



103567 C005
CABLE, MAIN POWER: 2 M - US

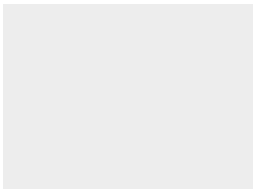

103566 C006
CABLE, MAIN POWER: 2 M -
FRANCE/GERMANY



060860 C014
FUSE 5X20 TEMP. 6.3 A



* C017
FUSE 5X20 TEMP. 16 A



106747 C022
PLUG, MAIN POWER



* C023
HARNESS, BASIC WIRING - 142

Pictures of components



* **C025**
HARNESS, 9 PTS BLOCK - 142S



* **C026**
HARNESS, 15 PTS BLOCK - 142

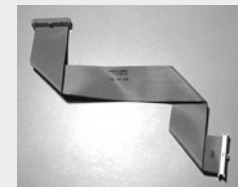

* **C027**
HARNESS, 34 PTS RS232 WIRING - 142/102S



* **C028**
HARNESS, 26 PTS RS232 WIRING - 142/102S



107650 **C060**
FUSE 5X20 TEMP. (+) 5 A

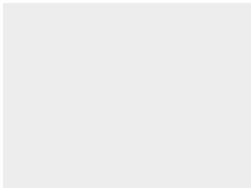

111280 **C061**
CIRCUIT BREAKER 16 A 115 V - 142

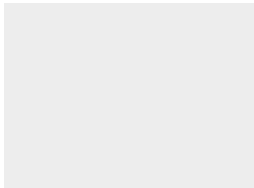

111281 **C062**
CIRCUIT BREAKER 8 A 230 V - 142



* **C064**
HARNESS, CALIBRATED LEAK WIRING



A459291 **C065**
FAN - 142/102S/122D

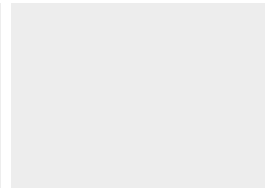

* **C088**
HARNESS, BLOCK FAN - 142S

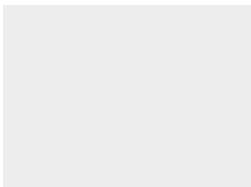

* **C089**
HARNESS, SPECIFIC WIRING - 142S

F 400 Automatic control system and electronic circuits



* **D001**
P0330E1 POWER SUPPLY BOARD - 142/182

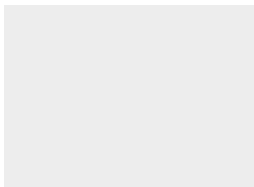

* **D003**
P0302E6S MAIN BOARD 122/142/182/192/1002



* **D004**
P0335E1 CONTROL PANEL BOARD - 142/182

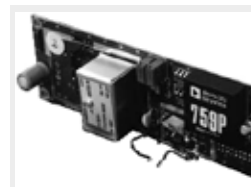

* **D007**
P0320E1 CELL 2G.1 MAIN BOARD



* **D009**
P0307E1 INTERFACE BOARD - 102S/142/122D

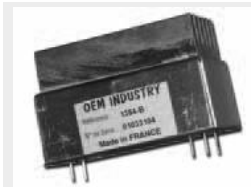

* **D012**
FILAMENT POWER SUPPLY - P0302



* **D013**
POWER SUPPLY MODULE - P0302

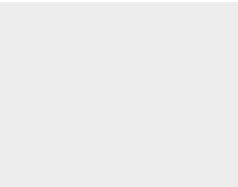

* **D015**
EPROM, VOICE SYNTHESIS - 142S

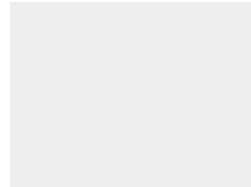

* **D018**
SOFTWARE EPROM - 142S



060097 **D026**
LOUDSPEAKER; 90 DB/D 10 CM

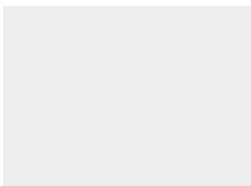

* **D045**
SOFTWARE EPROM - 142S

Pictures of components



F 500 Measurement

				
053146 <i>E001</i> *	<i>E002</i> *	<i>E003</i> *	101127 <i>E004</i>	102823 <i>E005</i>
FILAMENT ASSEMBLY FOR ANALYZER CELL	MAGNET 1 MASS - ANALYSIS CELL	CELL 2G.1; STD PRESET - 142/182/192/20MD	ELECTRON COLLECTOR, DOUBLE	SEAL, ELASTOMER; SPECIAL CELL
				
083486 <i>E006</i>	075612 <i>E007</i> *	<i>E008</i> *	<i>E009</i> *	<i>E010</i> *
SPECIAL WASHER FOR ANALYZER CELL	CHC SCREW M6-35	P0320E1 CELL 2G.1 MAIN BOARD	CELL, ANALYZER 2G1; EQUIPPED COVER	CELL, 2G.1; PREAMP. TARGET ASSEMBLY
				
<i>E011</i> *	<i>E012</i> *	A459843 <i>E013</i>	<i>E021</i> *	<i>E022</i> *
CELL, 2G.1; ELECT. DEFLECTION ASSEMBLY	CELL, ANALYZER 2G.1; ACCESSORIES KIT	COLLECTOR + FILAMENT KIT - 2G.1 CELL	P0203E1 CAL. LEAK TEMPERATURE SENSOR	HARNES, CALIBRATED LEAK WIRING
				
108111 <i>E023</i>	<i>E026</i> *	076112 <i>E038</i>	<i>E040</i> *	
CALIBRATED LEAK, INTERNAL - 142S/OPTION	FILAMENT FOR P11 GAUGE	SHOCK ABSORBER - C	CELL, ANALYZER : PACKAGING	

F 600 Pumping

				
056993 <i>F006</i>	205SFYLLS <i>F012</i>	205SFYHLS <i>F013</i>	068694 <i>F014</i>	067592 <i>F015</i>
GREASE SYRINGE FOR MDP/TMP	RVP UM 2005 SD LV A200 (Y) SCE (SERVICE)	RVP UM 2005 SD HV A200 (Y) SCE (SERVICE)	OIL, ALCATEL 200 (1L)	FUNNEL

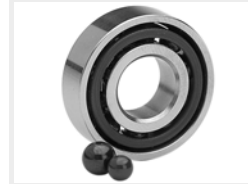
Pictures of components

107348 OIL MIST ELIMINATOR; 21 M3/H D 30 MM	<i>F016</i>	107646 QUICK FEMALE CONNECTOR D 12 MM RMI09	<i>F017</i>	107645 CLAMP, TUBE PRESS; 35.0/38.5 MM	<i>F019</i>	107648 CLAMP, TUBE PRESS; 12.8/15.0 MM	<i>F020</i>	A328645 HOSE, FLEXIBLE EXHAUST - 142	<i>F027</i>
									
* CERAMIC BEARING KIT 8.000 TMP	<i>F031</i>	* CERAMIC BEARING KIT 7.999/8.000 TMP	<i>F032</i>	* CERAMIC BEARING KIT 7.998/7.999 TMP	<i>F033</i>	* CERAMIC BEARING KIT 7.997/7.998 TMP	<i>F034</i>	* CERAMIC BEARING KIT 7.996/7.997 TMP	<i>F035</i>
									
* TOOL KIT FOR MDP5011/ATS100	<i>F036</i>	N1B602 AMP0071 - SERVICE	<i>F044</i>	* SEALS KIT, PERBUNAN - AMP0071	<i>F045</i>	* TOOL KIT FOR AMP0071	<i>F080</i>		

F 700 Valves

	067040 MINISOL VALVE COIL 24 V	<i>G001</i>	* COIL 24 VDC 23 W	<i>G002</i>	106935 VALVE KIT, NC BACOSOL (104655)	<i>G004</i>	106009 VALVE, MINISOL; 3/2 NF 24 VDC/8 W	<i>G007</i>	064600 VACUUM SILICON GREASE (100 G BOX)	<i>G012</i>
	* VALVE BLOCK, LOWER - 142/142D/142S	<i>G016</i>	* VALVE BLOCK, UPPER - 142S	<i>G017</i>	076112 SHOCK ABSORBER - C	<i>G029</i>	* VALVE BLOCK, UPPER - 142S	<i>G032</i>		

Pictures of components

F 800 Pipes		Connections		Seals					
	* TUBING, PVC; D 4 x 1 MM		A458324 CONNECTOR FOR PLASTIC TUBE 4 x 1		082988 BODY FEMALE CONNECTOR G 1/8 RBE03.2100		068370 BELLOWS, SS; DN25KF L 250 MM		083333 CLAMP DN10/16KF
	083264 CLAMP DN20/25KF		083267 CLAMP DN32/40KF		087163 CLAMP DN50KF		082775 MALE UNION BSPT F3BPL 2.7/4 - 1/8		106022 O'RING DN25KF HNBR
	106021 O'RING DN16KF HNBR		100983 DIAPHRAGM DN25KF - D 10 MM		068224 CENTERING RING DN25KF		072857 FILTER, DN25KF; 70 MICRONS		102823 SEAL, ELASTOMER; SPECIAL CELL
	303358 TEE, REDUCING - DN40/40/16KF		303359 TEE, REDUCING - DN50/50/16KF		068269 TEE, REDUCING - DN25/25/16KF		068193 CENTERING RING SS/PER DN16KF		068194 CENTERING RING SS/PER DN40KF
	087164 CENTERING RING SS/PER DN50KF		068189 CENTERING RING SS/PER DN25KF		107646 QUICK FEMALE CONNECTOR D 12 MM RMI09		107645 CLAMP, TUBE PRESS: 35.0/38.5 MM		107648 CLAMP, TUBE PRESS: 12.8/15.0 MM
	* SEALS KIT, PERBUNAN - AMP007I		083391 MALE CONNECTOR 4/6 MM - 1/8 BSPT		067843 FEMALE CONNECTOR 1/8 BSPT - LDS TUBE		079237 O'RING DN16KF NBR		082152 O'RING 1.78 x 12.42 NBR

Pictures of components

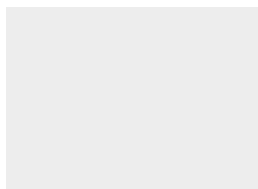

107641 *H125*
MALE PURGE FITTING (BHU 22-06 CPC)

F 900 Cover

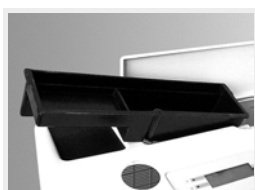

A212639 *I001*
CONTAINER - 142

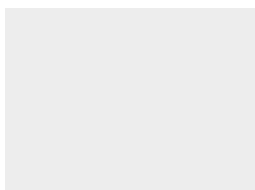

A459023 *I044*
FOOT - 142

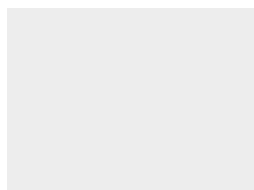

111930 *I059*
DETECTOR PACKAGING - 142

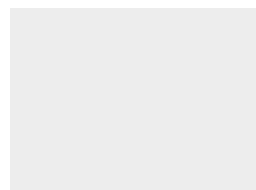

A462454 *I060*
COVER, WITHOUT LOGO - 142

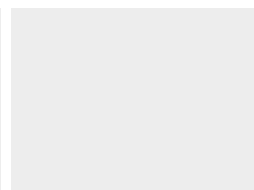

A462516 *I065*
LOGO - 142S

F 1000 Options and accessories



072606 *J001*
NEEDLE FOR LDS PROBE - D 0.3 MM



A461716 *J002*
NEEDLE FOR LDS PROBE - D 0.35 MM

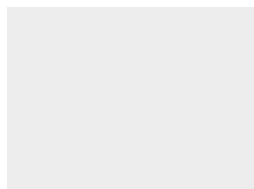

108242S *J003*
NOZZLE, SHORT RIGID - 2000 LD SNIFFER

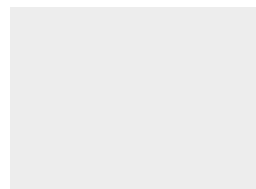

108243S *J004*
NOZZLE, LONG; FOR HE PROBE



108883S *J005*
NOZZLE, SHORT FLEXIBLE - 2000 LD SNIFFER

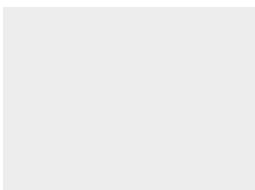

108884S *J006*
NOZZLE, LONG FLEXIBLE - 2000 LD SNIFFER



A459725 *J007*
HC SCREW M5-6 - 2000 LD SNIFFER

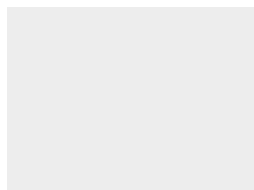

A459858 *J008*
5 FILTERS/2 SCREWS/2 O'RINGS - LDS PROBE



***** *J009*
FILTER, IN TUBING - LDS PROBE

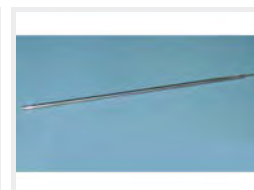

067838 *J010*
TUBE FOR LDS PROBE (OM)



072300 *J011*
TUBING, LDS - 5 METERS

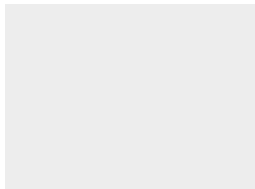

A459882 *J012*
TUBING, LDS - 10 METERS



083391 *J013*
MALE CONNECTOR 4/6 MM - 1/8 BSPT



067843 *J014*
FEMALE CONNECTOR 1/8 BSPT - LDS TUBE



083446 *J015*
TUBE HE SPRAY PROBE (OLD MODEL)

Pictures of components

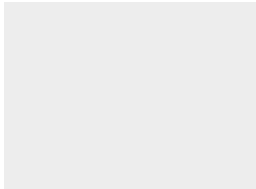

109955 *J016*
NOZZLE, SHORT RIGID; FOR HE PROBE

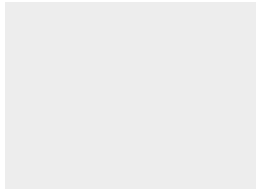

109956 *J017*
NOZZLE, LONG RIGID; FOR HE PROBE



A458735 *J018*
CABLE FOR REMOTE CONTROL 2G, 5 M

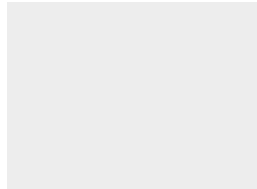

110881 *J019*
CABLE FOR REMOTE CONTROL 2G, 10 M

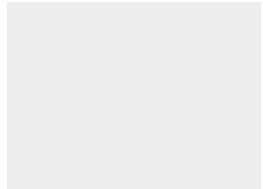

110882 *J020*
CABLE FOR REMOTE CONTROL 2G, 15 M



090216 *J034*
10 M EXTENSION - LDS PROBE



SNC1E1T1 *J035*
SNIFFER CANA.5 S R9 NIPPLE PENCIL



SNC1E2T1 *J036*
SNIFFER CANA.5 S R30 NIPPLE PENCIL



SNC1E3T1 *J037*
SNIFFER CANA.5 S S15 NIPPLE PENCIL



SNC1E4T1 *J038*
SNIFFER CANA.5 S S45 NIPPLE PENCIL



SNC2E1T1 *J039*
SNIFFER CANA.10 S R9 NIPPLE PENCIL



SNC2E2T1 *J040*
SNIFFER CANA.10 S R30 NIPPLE PENCIL



SNC2E3T1 *J041*
SNIFFER CANA.10 S S15 NIPPLE PENCIL



SNC2E4T1 *J042*
SNIFFER CANA.10 S S45 NIPPLE PENCIL



109951 *J043*
HELIUM SPRAY PROBE



***** *J048*
CELL 2G.1; MET PRESET - 142/182/192/20MD

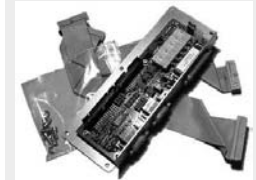

107657 *J059*
INTERFACE KIT - 142



***** *J060*
P0307E1 INTERFACE BOARD - 102S/142/122D

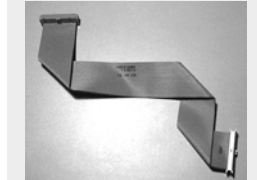

***** *J061*
HARNESS, 34 PTS RS232 WIRING - 142/102S



***** *J062*
HARNESS, 26 PTS RS232 WIRING - 142/102S

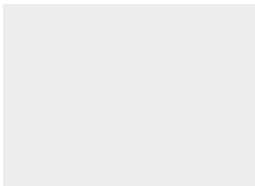

100807 *J074*
MAINTENANCE KIT FOR PRINTER

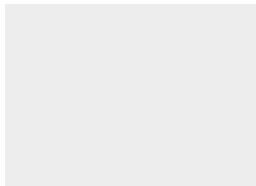

067722 *J076*
SNIFFER FILTER STONE

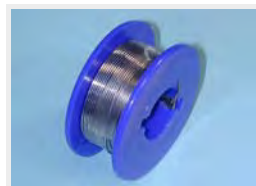

083478 *J080*
LEAD WIRE 10 M - 0.8 MM



112747 *J088*
REMOTE CONTROL LDS - Mbar/L/S

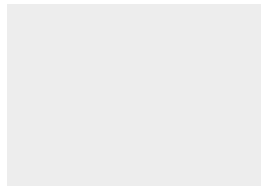

108111 *J089*
CALIBRATED LEAK, INTERNAL - 142S/OPTION



***** *J090*
P0203E1 CAL. LEAK TEMPERATURE SENSOR



***** *J091*
HARNESS, CALIBRATED LEAK WIRING



F 1100

Appendix

Pictures of components
ASM 142 S User's Manual
Detailed contents

Preliminary remarks Throughout this User's Manual, you could find this type of message "Summary of screen  C 140": it refers to a specific chapter of the User's Manual. Please read it for further information.

G 100

Declaration of conformity

G 200

Wiring diagrams

G 300

0 - 8 Volts Analog output

G 400

Long distance sniffer probe user manual

- Dimensions
- Technical characteristics
- Use precautions with the flexible sniffer probe
- Flow adjustment
- Available spare parts
- Filter exchange
- Needle replacement
- O'ring installation
- « Sniffer probe clogged » message
- Adaptador for calibrated leak

G 500

Helium spray gun user manual

- Description
- Technical characteristics
- Use precaution
- Spare parts

G 600

Safety questionnaire

Declaration of conformity

The declarations of conformity are available on request to AVTF in next languages: German/English/Danish/Spanish/French/Italian/Dutch/Portuguese.

ALCATEL

DECLARATION OF CONFORMITY

We, Alcatel Vacuum Technology France
98, Avenue de Brogny, BP 2069
74009 ANNECY FRANCE

ISO 9001 CERTIFIED

declare under our sole responsibility that the following products :

ASM 122 D / ASM 142 / ASM 142 S / ASM 142 D
ASM GRAPH / ASM GRAPH D / ASM GRAPH D

to which this declaration relates are in conformity with the following European Directives

73 / 023 / EEC	Low Voltage Directive
98 / 37 / EEC	Machinery Directive
89 / 336 / EEC	Electromagnetic Compatibility Directive
93 / 68 / EEC	Council directive (E.C. Marking)

The standards, normative documents, and/or specifications to which the products comply are :

NF EN 60204-1	Safety of Machinery / Electrical Equipment of Machinery
IEC 529	Degrees of protection provided by enclosures (IP codes)
NF EN 55022	EMC / Limits for Electromagnetical Conducted and Radiated Interferences
NF EN 61000-4-11	EMC / For mains power cuts
NF EN 61000-4-2	EMC / Immunity to Electrostatic Discharges
NF EN 61000-4-4	EMC / Immunity to Transient Burst
ENV 50140	EMC / Immunity to Radiated Electromagnetic field
NF EN 61000-4-6	EMC / Conducted disturbances induced by radio-frequency fields
ENV 50204	Radiated electromagnetic field from digital radio telephones - Immunity test.

Mr J.Y. GUEGAN, Président Directeur Général

Annecy, 11/10/05

G 200

Wiring diagram (index —)

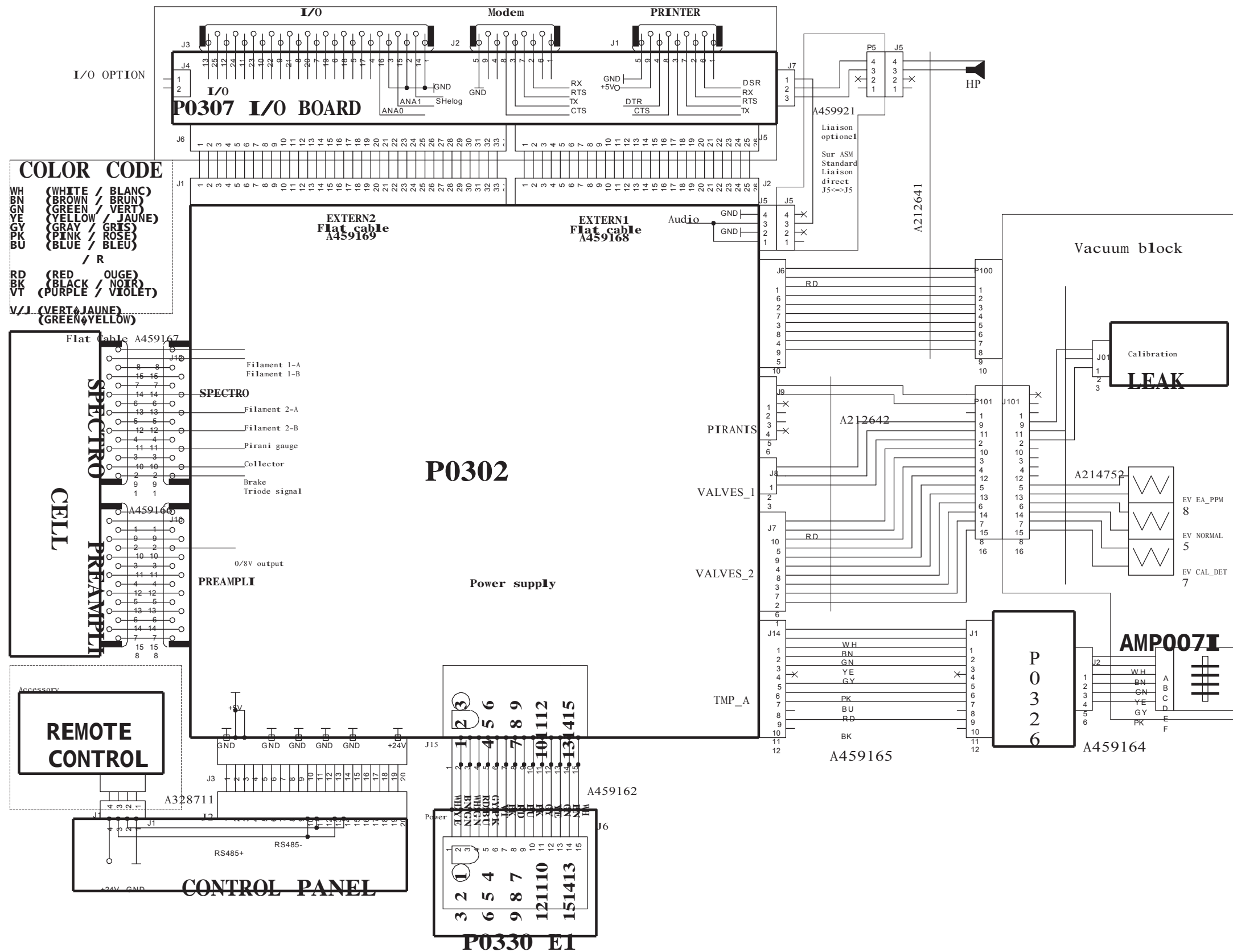

G 200

Wiring diagram (index —)

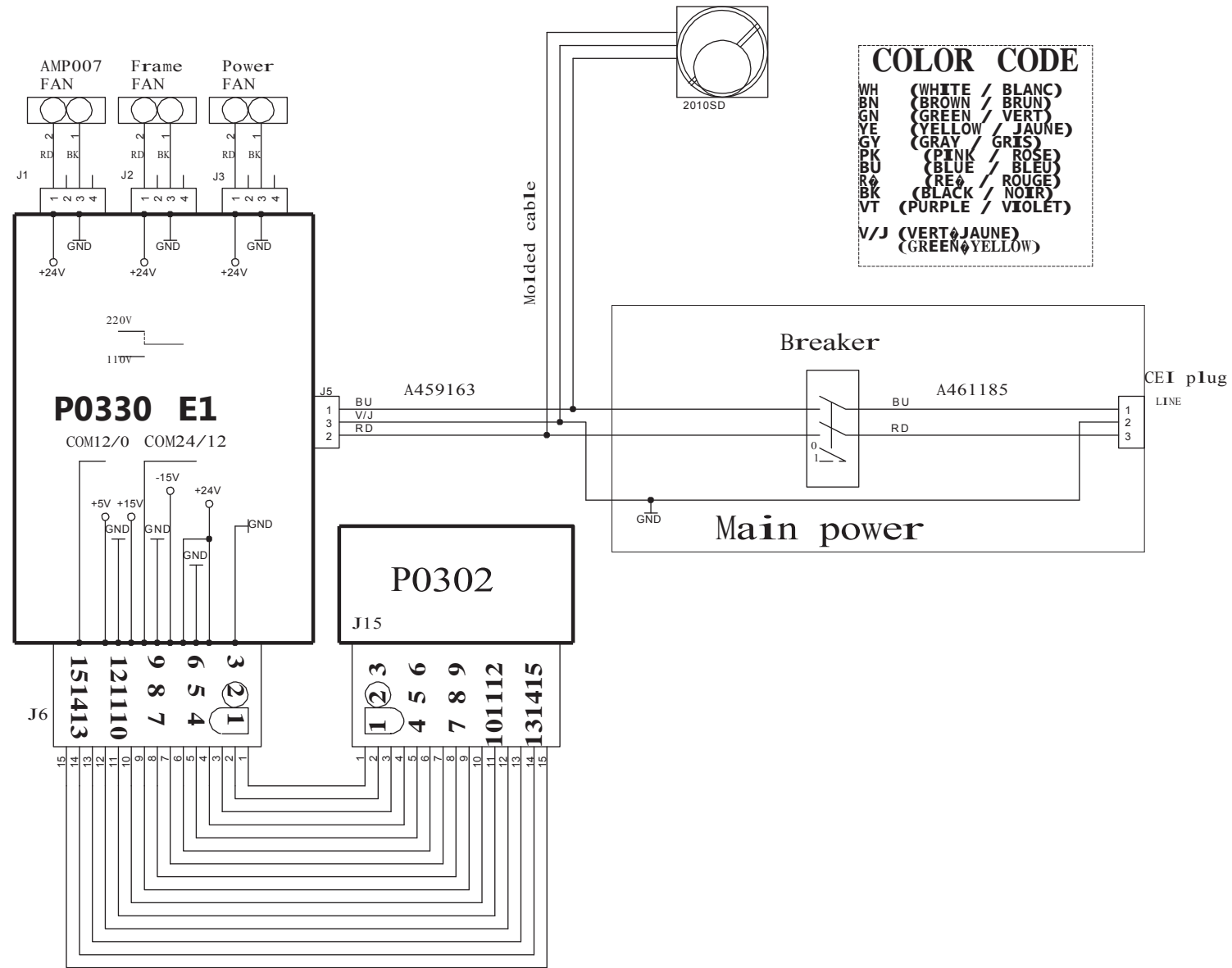

0 - 8 Volts Analog output

The purpose of the present chapter is to present the logarithmic response of this output.

Reminder:

The 0 - 8 Volt logarithmic output is located on the I/O interface connector:

	Ground	0 / 8 V
ASM 182/192 family - ASM 1002	Pin 15	Pin 14
ASM 142 family - ASM 122 D - ASM 102 S	Pin 1	Pin 14

- ‡ ASM 182/192 family, ASM 1002: signal connected (COEF.SENS and COEF.MODE applied)
- ASM 142 family, ASM 122 D, ASM 102 S: signal not corrected.

This output corresponds to the electronic signal obtained with the best sensitivity mode of the leak detector.

This output corresponds to the electronic signal obtained at the level of the analyzer cell (VHS amplification system) and does not include the correction factors generated by the internal and external calibration.

The chart and curve shows the correspondance between output voltage and helium signal. The helium signal given by the present chart needs to be multiplied by COEF.SENS which is adjusted during the internal (auto)calibration: refer to Calibration or Configuration menus (Chapter C) in order to get access to COEF SENS value. This COEF.SENS value is modified at each autocalibration: its takes into account the fact that the characteristics of the leak detector (analyzer cell and pumps status) and evolutes as it is used.

If an external correction ratio like VAC COR, SNIF COR or GL COR is activated, the helium signal given by the present chart also needs to be multiplied by this ratio: refer  C 300.

To get directly the corrected helium signal as it is displayed on the Digital display, use the 0 - 10 Volt linear output (refer to  B 300) on the same I/O interface connector.

Note: the pressure analog output is not the same as the helium output.

$$\left. \begin{array}{l} \text{Pressure P (mbar)} \\ \text{Voltage V (volt)} \end{array} \right\} \rightarrow P = 10^{(V-5.5)} \text{ mbar}$$

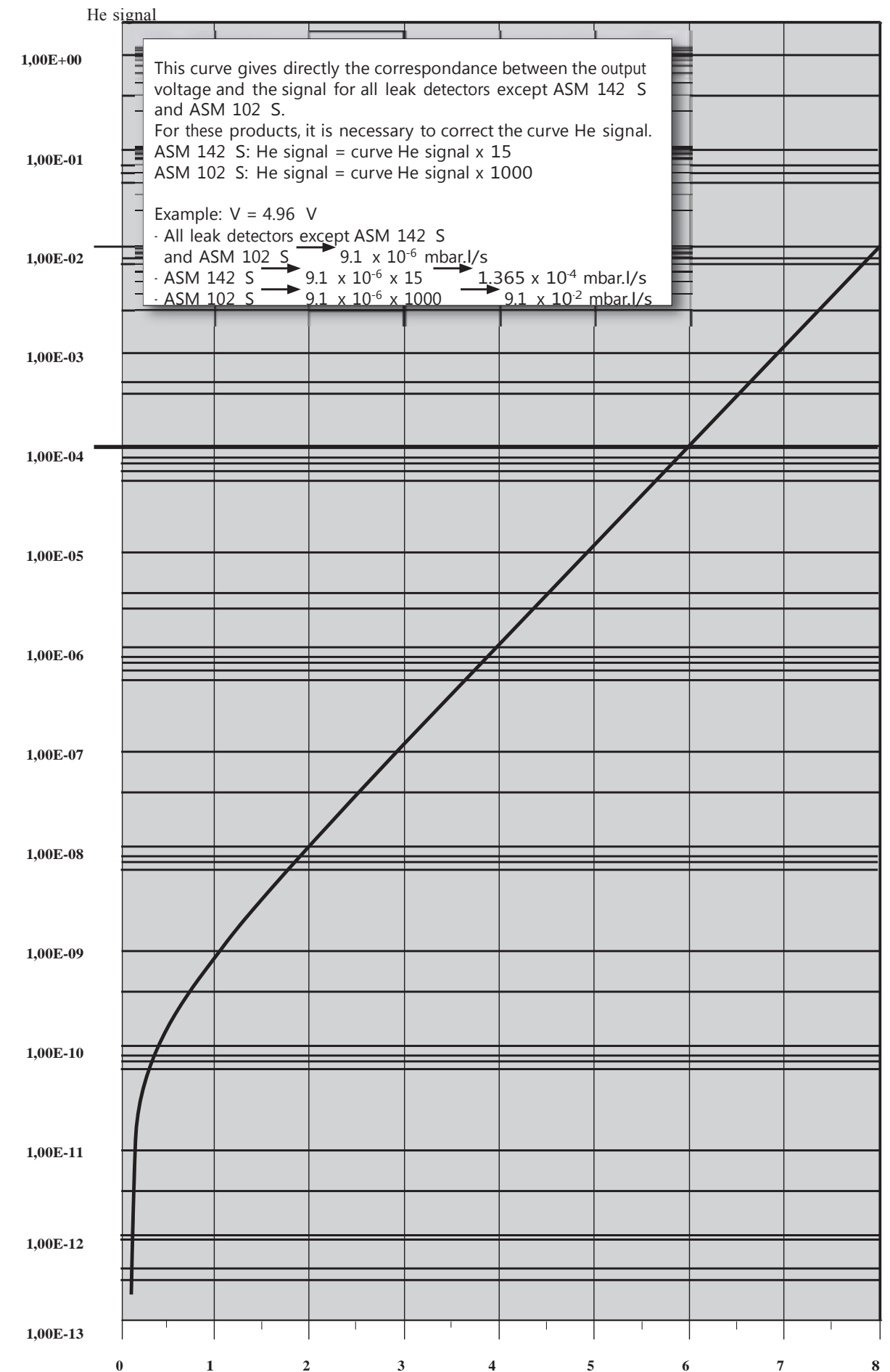

Voltage

G 200

This document concerns the p/n SNCxExTx long distance sniffer probes.



For all service operations, the long distance sniffer probe should be disconnected from the helium leak detector.

The parts involved are small: be careful not to loose them

Dimensions Dimensions of the sniffer probe end, for all sniffer probe models.

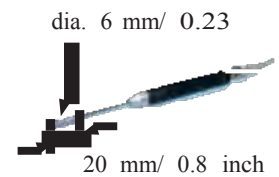

To calculate the complete size of the sniffer probe, add (A) and (C) depending on the sniffer probe model.

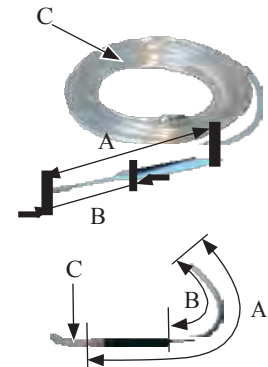

Example : sniffer probe p/n SNC1E1T1
 =
 gun (A) 19 cm + tubing (C) 5 m
 gun (A) 7.5 inch + tubing (C) 197 inch

End (B)		Sniffer probe part number	Gun (A)
Rigid	9 cm/3.5 inch	SNCxE1Tx	19 cm/7.5 inch
	30 cm/11.8 inch	SNCxE2Tx	40 cm/15.7 inch
Flexible	15 cm/5.9 inch	SNCxE3Tx	25 cm/9.8 inch
	45 cm/17.7 inch	SNCxE4Tx	55 cm/21.6 inch

	Sniffer probe part number	Tubing (C)
PVC flexible (external dia. : 6 mm/0.23 inch)	SNC1ExTx	5 m/197 inch
	SNC2ExTx	10 m/394 inch

Long distance sniffer probe user manual

Technical characteristics

	Sniffer probe with rigid nipple (part number SNCxE1Tx and SNCxE2Tx)	Sniffer probe with flexible nipple (part number SNCxE3Tx and SNCxE4Tx)
Helium concentration in the air	5 ppm	
Maximum flow taken by the probe	60 ± 2 sccm (1 mbar.l/s)	≈ 100 sccm
	Note: A flow variation in the sniffer probe does not modify the sensitivity but only the response time. \uparrow Flow = \uparrow Response time	
Leak flow (Q) read on the leak detector during a measurement of the He in the air without correction factor	$Q = 5 \cdot 10^{-6}$ mbar.l/s	$5 \cdot 10^{-6}$ mbar.l/s ≤ Q ≤ 10 ⁻⁵ mbar.l/s
Correction factor (Cor) to apply in order to read a leak flow in the leak detector of 5.10 ⁻⁶ mbar.l/s	1	0.5 ≤ Cor ≤ 1
Note		 Sniffer probe not designed for precise measurements

Use precautions with the flexible sniffer probe

- Do not step on the probe or flatten it.
- The nipple should not be curved (ref. ①) without respect the instructions below.
- The nipples should not be bent as shown below (ref. ② and ③).

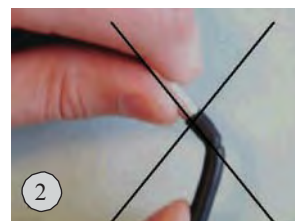

Long distance sniffer probe user manual

Use precautions with the flexible sniffer probe (continued)

□ The sniffer probe nipple can be bent if necessary but you should respect a minimum radius of curvature (ref. ④ and ⑤).

Sniffer probe with a flexible nipple of 15 cm / 5.9 inch (part number SNCxE3Tx)

Sniffer probe with a flexible nipple of 45 cm / 17.7 inch (part number SNCxE4Tx)

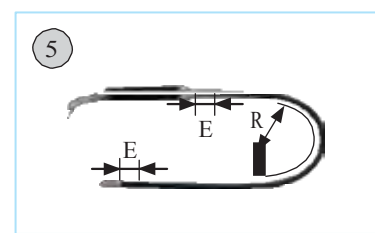
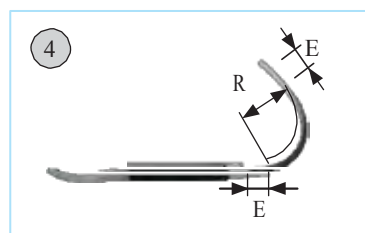

$R > 5 \text{ cm (2 inch)}$ $E > 2 \text{ cm (1 inch)}$: do not twist/bend the E section

Flow adjustment

In order to adjust the flow inside the sniffer probe, it comes equipped with 2 needle types: dia. 0.30 mm or 0.35 mm. This choice is done in factory and it is permanent.

How to identify the needle set in your sniffer probe?

□ The needle shape is different:

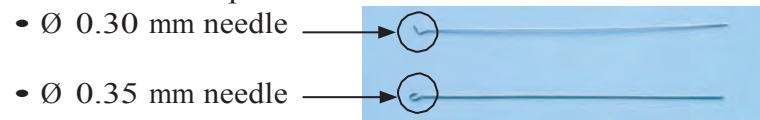

□ The sniffer probe nozzle is marked:



Sniffer probe equipped with a dia. 0.30 mm needle has no mark or is marked "0".



Sniffer probe equipped with a dia. 0.35 mm needle is marked "5".

Long distance sniffer probe user manual

Available spare parts

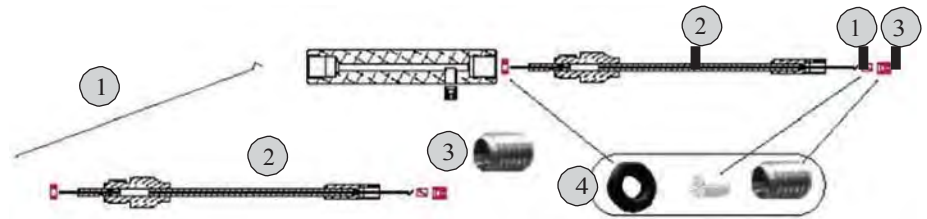

Designation	Reference	
dia. 0.30 mm needle	J 001	1
dia. 0.35 mm needle	J 002	
Rigid nozzle of 9 cm (*)	J 003	2
Rigid nozzle of 30 cm (*)	J 004	
Flexible nozzle of 15 cm (*)	J 005	
Flexible nozzle of 45 cm (*)	J 006	
(*) (delivered with the suitable needle not cut)		
Screw alone	J 007	3
Kit for sniffer probe with 5 filters, 2 O'rings and 2 screws	J 008	4

Reference part number F 1000

Filter exchange

- With the 2.5 Allen key, remove the screw at the end of the sniffer probe (ref. ①).
- Take out the old filter. Put the new filter in the port (ref. ②).
- Hold this assembly straight up and screw on the nipple of the sniffer probe (ref. ② and ③): torque < 1 N.m
- Install the screw so that it is totally inside the nipple : you should see a few threads (ref. ④ and ⑤).

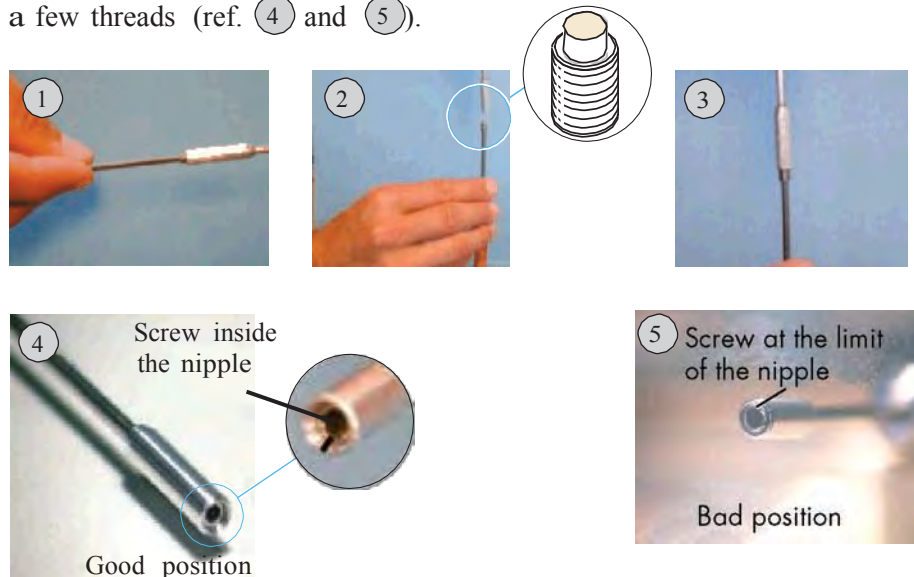

Long distance sniffer probe user manual

Filter exchange
(continued)

When you change the filter, we recommend cleaning the needle and the nipple (sniffer probe with rigid nipple only):

- Take out the needle with needlenose pliers.
- Clean delicately the needle with alcohol and a lint-free cloth.
- Clean the rigid nipple with alcohol and compressed dry air.
- Put back the needle.
- Put back the filter with its screw: torque < 1 N.m.

Needle replacement

With this kind of sniffer probe, it is normally not necessary to change the needle.

For every needle replacement in a sniffer probe, put a new needle with the same diameter as the old needle.

3 methods can be used for the new needle adjustment :

- ① flowmeter use
 - ② standard sniffer probe use
 - ③ old needle use
- } Recommended methods

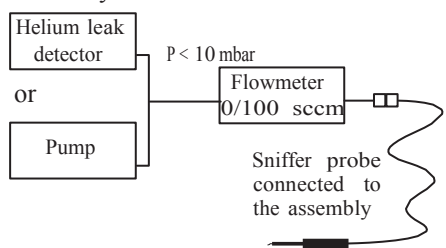
<p>1 Flowmeter use in order to measure the flow in the sniffer probe</p>	<p>2 Standard sniffer probe use as reference</p>
<p>Assembly to do:</p> 	<p>This method requires keeping a new sniffer probe as a standard probe. Do an auto-calibration in sniffing mode with the standard sniffer probe. Do a measure of the He in the air with the standard sniffer probe.</p>
<p>Cut the new needle to 85 mm/3.35 inch. Prepare it (see below “③ Use of the old needle as a reference“, picture ③) and put it correctly in the nozzle (see “Needle exchange” §).</p>	

Long distance sniffer probe user manual

Needle replacement
(continued)

1 Flowmeter use (cont.)	2 Standard sniffer probe use (cont.)
	In a no helium polluted environment, do a measure of the helium in the air with the sniffer probe to adjust.
Depending on the measure result, cut the needle according to the precautions indicated below. Put back correctly the needle in the nozzle.	
Repeat these operations until the flowmeter displays the value of the maximum flow taken by the sniffer probe (60 ± 2 sccm).	Repeat these operations until the display corresponds to the display with the standard sniffer probe in the helium of the air.
If the message "sniffer probe clogged" appears in the control panel display during these adjustments, please refer to "Sniffer probe clogged" message §.	

Precautions to cut the needle.

It is necessary to cut small amounts of the needle, especially when we are near the target value: refer to the figure below.

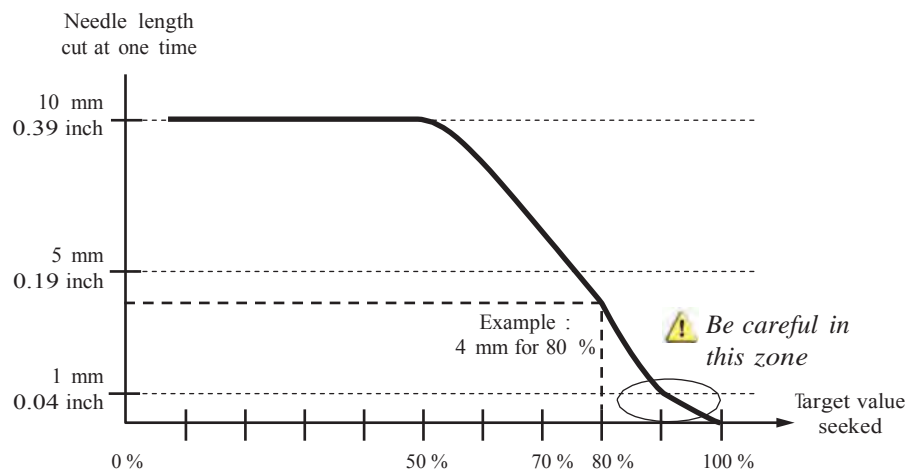

- Example:
- target value = 60 sccm
 - value displayed on the flowmeter : 48 sccm (= 80 % of the target value)
 - remove the needle from the nozzle and cut 4 mm from the straight end.

③ Use of the old needle as a reference

With this method, the uncertainty about the maximum flow taken by the sniffer probe is more important :

- Maximum flow taken: 60 ± 10 SCCM
- Leak flow (Q): $4 \cdot 10^{-6}$ mbar.l/s $< Q < 6 \cdot 10^{-6}$ mbar.l/s.

Take out the filter (see "Filter exchange" §).

Long distance sniffer probe user manual

With needlenose pliers, take out the original needle.

Put the new needle (ref. ①) and cut to the same length as the original needle.

Note:

For the flexible sniffer probe (SNCxE3Tx and SNCxE4Tx), the needle length should be 2.5 cm (ref. ②).

Bend the needle as shown in the picture ③.

Put the needle in the nipple, the crooked end to outside (ref. ④) and push it in with a 2.5 allen key to stop.

Put back the filter.

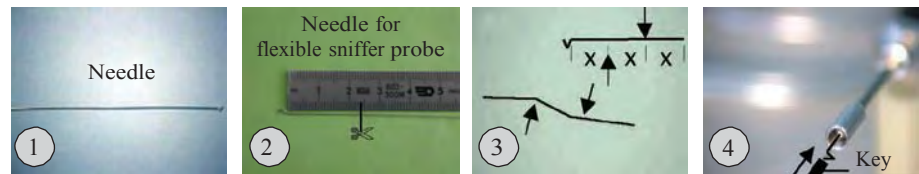

O'ring installation

□ When you unscrew the nipple from the probe, it is possible for the o'ring to come out with the nipple : you should put it back (ref. ①).

□ Place the o'ring on the nipple of the aspiration tube in the sniffer body (ref. ②).

□ Push the o'ring with the nipple of the sniffer probe (ref. ③).

□ The o'ring is correctly placed on the nipple (ref. ④).

□ Screw on the nipple of the sniffer probe.

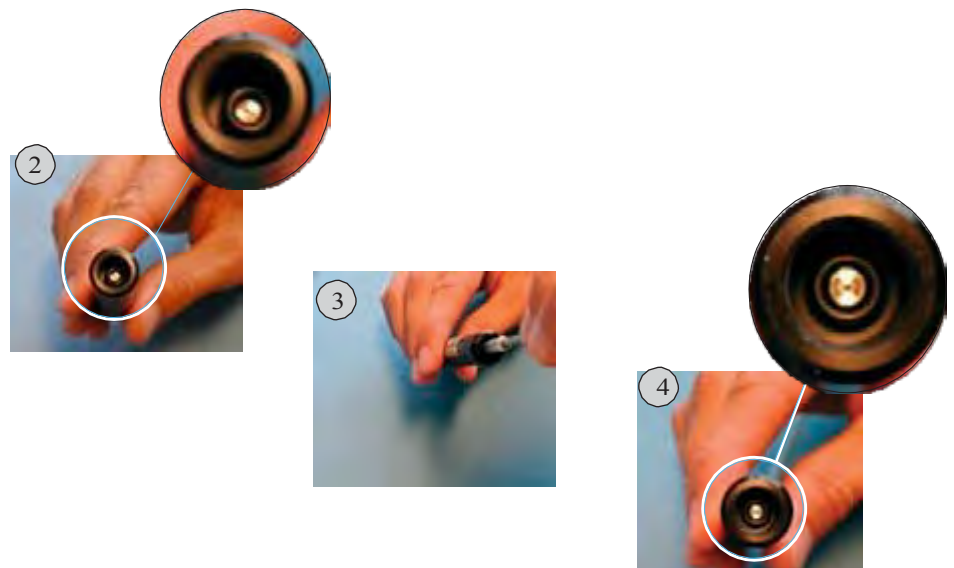
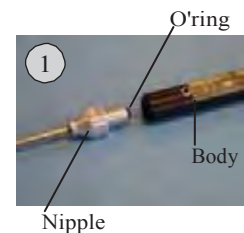

Long distance sniffer probe user manual

"Sniffer probe clogged" message

A "Sniffer probe clogged" message could appear on the control panel LCD display or be announced by the digital voice: the leak detector compares the helium signal read on the detector to the sniffer probe clogged reject threshold.

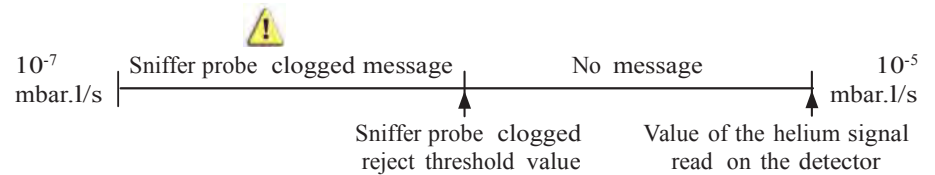

During the needle adjustment, this message could appear without the sniffer probe necessarily being clogged: this is why the needle length is so important.

For more details, please consult the user's manual delivered with your leak detector.

Advice:

Block the sniffer probe end from time to time with a finger to check that the helium signal goes down. If not, the sniffer probe may be clogged.

Adaptator for calibrated leak

Description	Reference
Adaptor for DN 16 calibrated leak	A 006
Adaptor for DN 25 calibrated leak	A 007

Reference part number F 1000



Special adaptors for calibrated leaks have been designed to ensure a good connection and repetitive and reliable calibration with a sniffer probe.

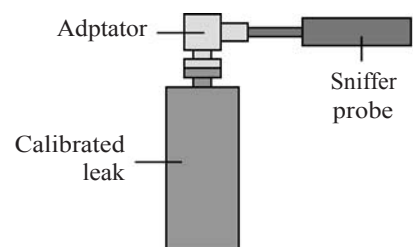

With the adaptor for calibrated leaks use:

$$\text{Value read on the leak detector} = \text{calibrated leak value} + \text{value of the helium in the air}$$

Helium spray gun user manual

Description

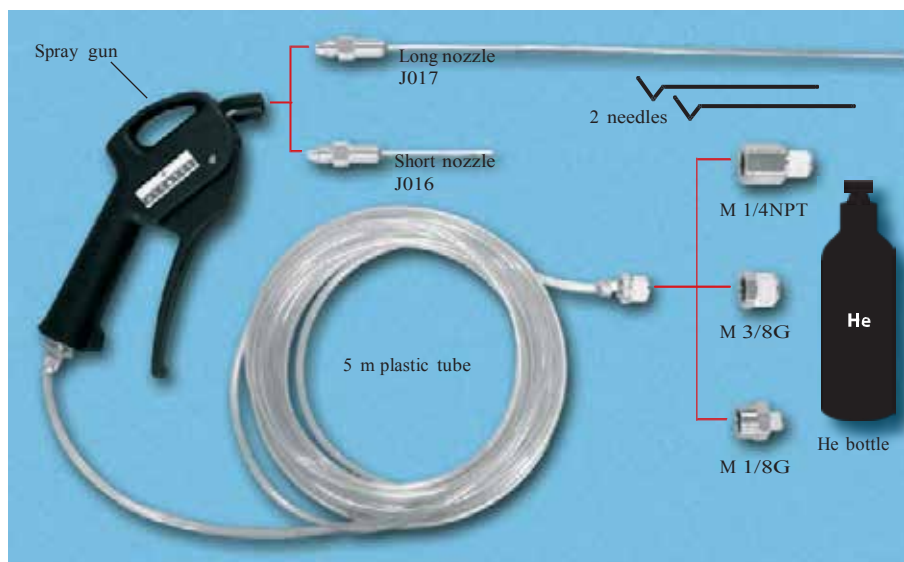

Kitpart number  A 700

Technical characteristics

Maximum pressure at the outlet of the helium bottle regulator	3 Bars relative / 42 PSI
Recommended pressure at the outlet of the helium bottle regulator	1.5 Bar relative / 7 PSI

	short end				long end			
	needle		regulator pressure	flow	needle		regulator pressure	flow
	used	length			used	length		
rough and fast detection	no		0.5 / 1 bar	> 1000 ml/mn	no		0.5 / 1 bar	> 500 ml/mn
highly specialized detection	yes	80 mm	0.5 bar	60 ml/min	yes	175 mm	0.5 bar	60 ml/min

Helium spray gun user manual

Use precaution It is possible to reduce the flow: put the needle as show on the picture and cut if necessary.

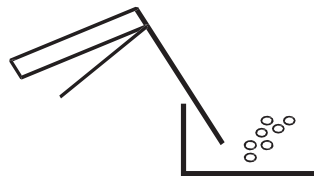

Before testing, always check helium goes out of the end.

Spare parts

Description	Reference
Long end	J 017
Short end	J 016
Needle	J 001

Reference part number  F 1000

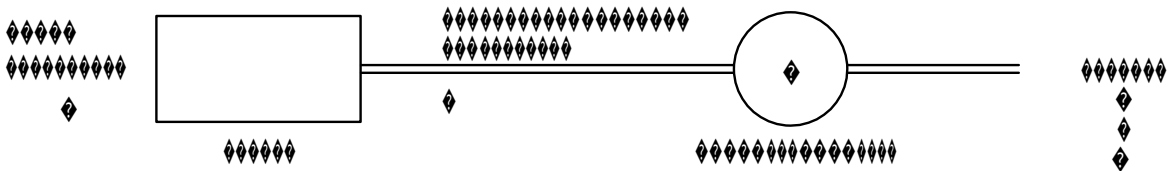
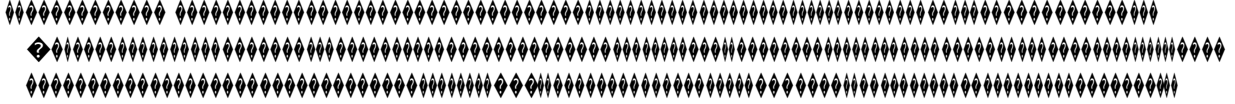
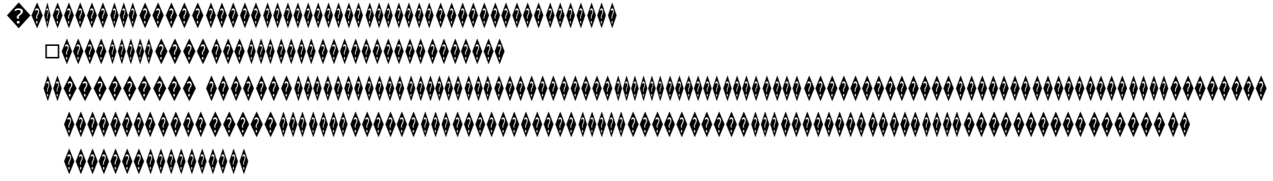
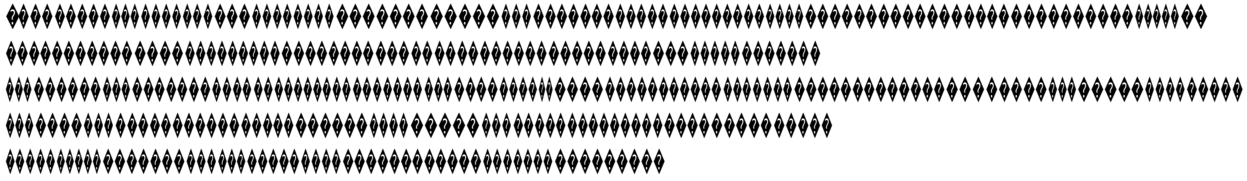



QUESTIONNAIRE DE SECURITE SAFETY QUESTIONNAIRE

Procédure de retour des Pompes à Vides et Détecteur de Fuite à Hélio ALCATEL
Procedure for returning ALCATEL Vacuum Pumps and Helium Leak Detectors (Ce formulaire ne peut être rempli et signé que par une personne habilitée)
(This questionnaire is only to be filled in and signed by an authorized person)

SOCIETE - COMPANY Non Société – Name of company : Non personne – Name of person : <small>(Qui remplit ce formulaire) – (Who has filled in questionnaire)</small> Fonction – Position : N° Tél. – Tel. no : N° Fax – fax no : <small>(Pour renseignements éventuels sur les produits utilisés) – (for any information on products used)</small>	EQUIPEMENT - EQUIPEMENT Description : N° de Série – Serial no : Type de procédé – type of process : <small>(Pour lequel l'équipement est utilisé) – (for which equipment is used)</small> Date de l'expédition – Date of consignment :																								
INTERVENTION - SERVICE Intervention souhaitée (Révision, réparation,...) – Service required (overhaul, repair, etc.): Type d'anomalie constatée – Type of anomaly observed:																									
PROCEDE CUIVRE – COPPER PROCESS Produit utilisé sur un procédé Cuivre – Product used on a Copper process Oui – Yes Non – No Si "Oui" emballage étanche et étiquette spécifique sont requis - If "Yes", sealed package and specific label are required																									
ASPECT SECURITE – SAFETY ASPECT L'équipement mentionné ci-dessus a été en contact avec les produits suivants – The above equipment has been in contact with the following substances : <small>(nom et formule chimique) – (name and chemical formula)</small>																									
Ces produits présentent un risque de nature <i>These substances present the following risks</i>																									
Chimique – Chemical <table style="width: 100%; border: none;"> <tr> <td style="width: 30%;">Toxic – Toxic</td> <td style="width: 30%;">Oui – Yes</td> <td style="width: 30%;">Non – No</td> </tr> <tr> <td>Carcinogénique - Carcinogenic</td> <td>Oui – Yes</td> <td>Non – No</td> </tr> <tr> <td>Combustible - Combustible</td> <td>Oui – Yes</td> <td>Non – No</td> </tr> <tr> <td>Corrosive - Corrosive</td> <td>Oui – Yes</td> <td>Non – No</td> </tr> <tr> <td>Explosive - Explosive</td> <td>Oui – Yes</td> <td>Non – No</td> </tr> <tr> <td>Biologique – Biological</td> <td>Oui – Yes</td> <td>Non – No</td> </tr> <tr> <td>Radioactive – Radioactive</td> <td>Oui – Yes</td> <td>Non – No</td> </tr> <tr> <td>Autre – Other</td> <td></td> <td></td> </tr> </table> <small>(Vous reporter éventuellement à la page précédente) – (See preceding page if necessary)</small>	Toxic – Toxic	Oui – Yes	Non – No	Carcinogénique - Carcinogenic	Oui – Yes	Non – No	Combustible - Combustible	Oui – Yes	Non – No	Corrosive - Corrosive	Oui – Yes	Non – No	Explosive - Explosive	Oui – Yes	Non – No	Biologique – Biological	Oui – Yes	Non – No	Radioactive – Radioactive	Oui – Yes	Non – No	Autre – Other			Explication détaillée – Detailed explanation Si "Oui" risque de nature – If "Yes", what type of risk
Toxic – Toxic	Oui – Yes	Non – No																							
Carcinogénique - Carcinogenic	Oui – Yes	Non – No																							
Combustible - Combustible	Oui – Yes	Non – No																							
Corrosive - Corrosive	Oui – Yes	Non – No																							
Explosive - Explosive	Oui – Yes	Non – No																							
Biologique – Biological	Oui – Yes	Non – No																							
Radioactive – Radioactive	Oui – Yes	Non – No																							
Autre – Other																									
SIGNATURE Vous avez répondu "Oui" à une des questions précédentes : Je confirme que seules les substances précisées ont été en contact avec l'équipement sus-mentionné, et que les procédures de préparation, d'emballage, et de transport ont été respectées. <i>You have replied "yes" to one of the above questions: I confirm that only the substances mentioned have been in contact with the above equipment and that the preparation, packing and transport procedures have been complied with.</i>	Je confirme que le matériel sus-mentionné n'a été en contact avec aucune substance dangereuse, et a été vidé de son huile. (Si applicable) <i>I confirm that the above equipment has not been in contact with any dangerous substance and has been emptied of oil. (if applicable)</i>																								
Réponse "Oui" (nécessite une protection) <i>Reply "Yes" (requires protection)</i>	Réponse "Non" (sans risque) <i>Reply "No" (no risk)</i>																								
Nom – Name : Fonction – Position : Date : Signature autorisée – Authorised signature :	Fonction – Position : Date : Signature autorisée – Authorised signature:																								
Tampon / Cachet Stamp / Seal	Tampon / Cachet Stamp / Seal																								

CHINA

Alcatel Vacuum Technology, Shanghai
N°82 Lane 887 Zuchongzhi Road
Zhangjiang High-Tech Park,
Shanghai 201203 - P.R. China
Tel. (86) 21 5027 0628
Fax. (86) 21 3895 3815

FRANCE

Alcatel Vacuum Technology France
98, avenue de Brogny - BP 2069
74009 Annecy cedex
Tel. (33) 4 50 65 77 77
Fax. (33) 4 50 65 77 89

GERMANY

Alcatel Hochvakuumtechnik GmbH
Am Kreuzeck 10 - Postfach 1151
97877 Wertheim
Tel. (49) 9342 9610 00
Fax. (49) 9342 9610 30

ITALY

Alcatel Vacuum Systems
Via Trento, 30
20059 Vimercate (Mi)
Tel. (39) 0396 86 38 55
Fax. (39) 039 66 71 25

JAPAN

Alcatel Vacuum Technology Japan
4-3-10 Shimokodanaka,
Nakahara-ku
Kawasaki, Kanagawa 211-0041
Tel. (81) 44-797-5920
Fax. (81) 44-797-5932

KOREA

Alcatel Vacuum Technology Korea
4th Floor, Sunghyun B/D
10-5, Karak-Dong, Songpa-Ku -Seoul
Tel. (82) 2 409 6277
Fax. (82) 2 409 6279

SINGAPORE

Alcatel Singapore Pte Ltd
49 Jalan Pemimpin
#01-01 APS Industrial Building
577203 Singapore
Tel. (65) 62540828
Fax. (65) 62547018

TAIWAN

Alcatel Vacuum Taiwan
No. 169-3, Sec.1, Kang-Leh Rd
Song-Lin Village, Hsin-Feng 304
Hsin-Chu County, Taiwan -R.O.C.
Tel. (886) 35599230
Fax. (886) 35599231

UNITED KINGDOM

Alcatel Vacuum Technology UK Ltd
8 Bain Square Kirkton
Campus Livingston - West
Lothian EH54 7DQ
Scotland
Tel. (44) 1 506 418 000
Fax. (44) 1 506 418 002

USA

Alcatel Vacuum Products
67, Sharp Street
Hingham - MA 02043
Tel. (1) 781 331 4200
Fax. (1) 781 331 4230



Alcatel Vacuum Technology France - 98, avenue de Brogny - BP 2069 - 74009 Annecy cedex - FRANCE
Tel. (33) 4 50 65 77 77 - Fax. (33) 4 50 65 77 89
Web site: www.adixen.com