



OPERATING INSTRUCTIONS

EN

Translation of the original instructions

ASM 390 - ASM 392

Leak detector

PFEIFFER  **VACUUM**

Table of contents

1	About this manual	5
1.1	Validity	5
1.1.1	Applicable documents	5
1.2	Conventions	6
1.2.1	Safety instructions	6
1.2.2	Pictographs	6
1.2.3	Instructions/Abbreviations used	6
1.2.4	Labels	7
2	Safety	9
2.1	Safety precautions	9
2.2	Protective equipment	10
2.3	Proper use	11
2.4	Improper use	11
3	Transport and storage	12
3.1	Unpacking / repacking	12
3.2	Transport	13
3.3	Storage	13
4	Product description	15
4.1	Product identification	15
4.1.1	Scope of delivery	15
4.1.2	Variants	15
4.2	Interface connection	16
5	Installation	18
5.1	Prerequisites for optimising measurement	18
5.2	Operating conditions	18
5.3	Set-up	18
5.4	Purge and inlet vent connection	19
5.4.1	Connection	19
5.5	Connection to the mains power supply	19
5.6	Operating for the first time	20
5.6.1	Familiarise yourself with the control panel	20
5.6.2	Become familiar with the detector	20
5.7	Connecting the part/installation to be tested	20
5.8	Connecting the exhaust	21
5.9	Control panel fixing	21
5.10	Hose holder fixing	21
5.11	Storage	22
6	Operation	24
6.1	Control panel	24
6.1.1	Description	24
6.1.2	Contrast - Brightness - Screen Saver	25
6.1.3	Application screens	25
6.1.4	"Standard" screen	26
6.1.5	"Settings" screen	26
6.1.6	"Graph" screen	26
6.1.7	"Vacuum circuit" screen	26
6.1.8	"Measurement" window	27
6.1.9	Function keys	27
6.2	Prerequisites to use	27
6.3	Switching the detector on	28
6.3.1	Switch on	28
6.3.2	Starting a test	28
6.3.3	Test launched automatically upon start-up	29
6.4	Monitoring operation	29
6.5	Shutdown the detector	29

6.6	Saving and downloading the product's configuration	29
6.6.1	Saving the configuration	29
6.6.2	Downloading the configuration	30
6.7	Calibration	30
6.7.1	Calibration in Hard Vacuum test	30
6.7.2	Calibration in Sniffing test	32
7	Advanced settings	34
7.1	"Graph" screen	34
7.1.1	Description	34
7.1.2	Settings	34
7.1.3	Scales setting	34
7.1.4	Graph clearing	35
7.1.5	Recording	35
7.1.6	Saving a recording	36
7.1.7	Viewing a recording	37
7.2	Settings	38
7.2.1	Tree diagram of the "Settings" menus	38
7.3	Set points Menu	38
7.3.1	Audio alarm and digital voice	39
7.3.2	Pollution function	39
7.3.3	Hard Vacuum reject point	39
7.3.4	Sniffing reject set point	40
7.3.5	Probe clogged set point	40
7.3.6	Other Set points	40
7.3.7	Other Pressure set point	40
7.4	"Test" Menu	41
7.4.1	Test methods	41
7.4.2	Correction factor	41
7.4.3	Test mode	42
7.4.4	Type of probe	42
7.4.5	Automatic Cycle End	42
7.4.6	Inlet vent	43
7.4.7	Memo function	44
7.4.8	Zero activation	44
7.4.9	Bypass Option	44
7.4.10	Regeneration	45
7.4.11	Massive mode	46
7.5	Spectro Menu	46
7.5.1	Tracer gas	46
7.5.2	Filament parameters	47
7.5.3	Calibrated leak	47
7.6	Maintenance Menu	48
7.6.1	Detector	48
7.6.2	Timers	48
7.6.3	Detector Information	49
7.6.4	Pump Information	49
7.6.5	Event history	50
7.6.6	Calibration history	50
7.6.7	Burn-in	51
7.6.8	Maintenance for the analyzer cell and the secondary pump	51
7.6.9	Last maintenance	51
7.7	Configuration Menu	51
7.7.1	Time - Date - Unit - Language	52
7.7.2	Function keys	52
7.7.3	Application screens	53
7.7.4	Screen Settings	55
7.7.5	Access - Password	55
7.8	Advanced Menu	58
7.8.1	Leak Detection Menu	58
7.8.2	Leak Detection: Start-up timer	58
7.8.3	Leak detection: Background suppression	58
7.8.4	Leak Detection: Crossover Pressures	59
7.8.5	Leak Detection: Calibration	59
7.8.6	Leak detection: Analyzer cell	60
7.8.7	Leak Detection: Internal Pirani gauge calibration	60
7.8.8	Leak Detection: External gauge	61
7.8.9	Leak Detection: Purge valve	61
7.8.10	Input/Output menu	61
7.8.11	Input/Output: Serial Link 1 and Serial Link 2	62

	7.8.12 Input/Output: I/O connector	62
	7.8.13 SD Card menu	62
	7.8.14 Service	62
8	Maintenance / replacement.	63
	8.1 Maintenance intervals and responsibilities	63
9	Service	64
10	Accessories	65
11	Technical data and dimensions	66
	11.1 General	66
	11.2 Technical data	66
	11.3 Units of measurement	66
	11.4 Dimensions	67
12	Appendix	68
	12.1 Tree diagram of the "Settings" menus	68
	Certification to UL 61010-1	76
	Certification to SEMI S2	77
	Declaration of conformity.	78

1 About this manual

1.1 Validity

This operating manual is for customers of Pfeiffer Vacuum. It describes the functioning of the designated product and provides the most important information for safe use of the unit. The description follows applicable EU guidelines. All information provided in this operating manual refers to the current state of the product's development. The documentation remains valid as long as the customer does not make any changes to the product.

Up-to-date operating instructions can also be downloaded from www.pfeiffer-vacuum.com.

This manual covers products with the following part numbers:

Part number	Description
CSGB01GxMM9x	ASM 390
ESGB02GxMM9x	ASM 392

1.1.1 Applicable documents

Documents relevant for the use of options and/or accessories, and for product maintenance are the following:

ASM 390-392	Operating instructions
ASM 390-392 Maintenance instructions	P/n 126348M
RS-232 Operating instructions	P/n 122215*
Operating instructions for the 15 pin I/O board	P/n 121776*
Operating instructions for the 37 pin I/O board (Wi-Fi + Ethernet + USB)	P/n 123894*
External Communication Box WiFi Operating instructions	P/n 126169
Standard Sniffer Probe Operating instructions	P/n 121780*
Smart Sniffer Probe Operating instructions	P/n BG5268B
Standard Sniffer Probe Operating instructions	P/n 121781*
RC10 Remote Control Operating instructions	P/n 124628
Bypass Operating instructions	P/n PL0004B
Bottle holder kit Operating instructions	P/n126760
Declaration of conformity CE	Included with this manual
Declaration of conformity SEMI	Included with this manual
Certification UL 61010-1	Included with this manual

*also available at www.pfeiffer-vacuum.com

1.2 Conventions

1.2.1 Safety instructions

Operating manual safety instructions Pfeiffer Vacuum are based on the UL, CSA, ANSI Z-535, SEMI S2, ISO 3864 and DIN 4844 certification standards. This document describes the following information and danger levels:

DANGER
<p>Imminent danger Indicates an imminent hazardous situation that will result in death or serious injury.</p>
WARNING
<p>Possibly imminent danger Indicates an imminent hazardous situation that can result in death or serious injury.</p>
CAUTION
<p>Possibly imminent danger Indicates an imminent hazardous situation that can result in minor or moderate injury.</p>
NOTICE
<p>Command or note Command to perform an action or information about properties, the disregarding of which may result in damage to the product.</p>

1.2.2 Pictographs



Prohibition of an action to avoid any risk of accidents, the disregarding of which may result in serious accidents



Warning of a displayed source of danger in connection with operation of the unit or equipment

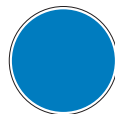

Command to perform an action or task associated with a source of danger, the disregarding of which may result in serious accidents

1.2.3 Instructions/Abbreviations used

⇔ or →

Work instruction: you must perform an operation here.

[XXXX]

You must press the **XXXX** key on the control panel.



Example: press the "Home" key on the control panel to return to the «Standard» screen.

I/O

Inputs/Outputs

⁴He

Helium 4

³He

Helium 3

H₂

Hydrogen

1.2.4 Labels

This chapter lists all the labels that could appear on the product as well as their meaning.

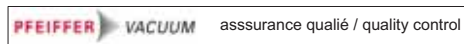

Safety label: guarantee that the packing has not been opened since leaving the factory.



Indicates an electric shock hazard in case of contact:

- ⇒ do not use the product if the power cable is not earthed,
- ⇒ disconnect the electrical power supply before working on the product.

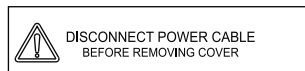

Indicates an electrical shock hazard in case of contact:

- ⇒ disconnect the electrical power supply before removing the cover and working on the product.

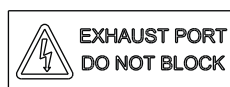

Indicate that the detector exhaust port should not be blocked.



Locate a grounding point on the product.

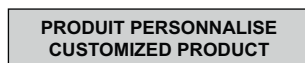

Customization label for the product according to the customer's request.



Quality: certifies that the product has been certified compliant with quality control upon leaving the factory.

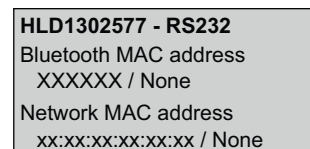

Indicates whether the Bluetooth, Wi-Fi or Ethernet options have been installed on the products, and their MAC addresses.

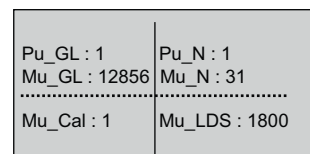

For service centers use only.

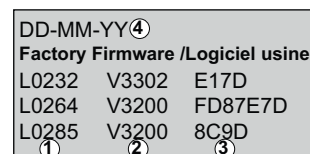

Indicates the firmware versions installed on the product.

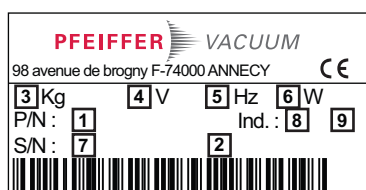

- 1) Firmware name
- 2) Firmware version
- 3) Firmware checksum
- 4) Publication date

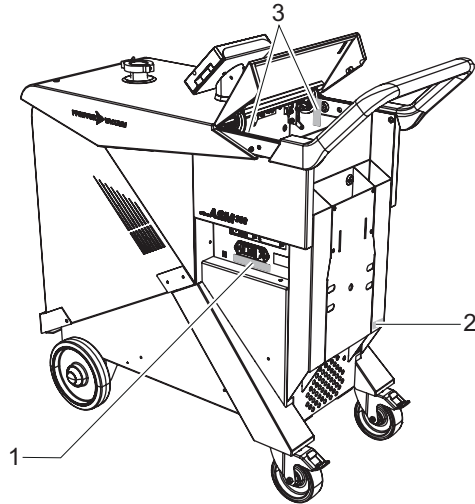

Product identification label (see 4.1).



Labels localisation (1) / (2) / (3)

(1)	(2)	(3)
 <p>DO NOT OPERATE WITH UNGROUND POWER CABLE DISCONNECT BEFORE MAINTENANCE</p>	 <p>DISCONNECT POWER CABLE BEFORE REMOVING COVER</p>	 <p>EXHAUST PORT DO NOT BLOCK</p>

2 Safety

2.1 Safety precautions



Obligation to inform

Any person responsible for installing, using or maintaining the product must first read the security instructions in this operating manual and comply with them.

→ It is the operating customer's responsibility to protect all operators against the dangers associated with the product, with the media pumped and with the entire installation.



Installation and use of the accessories

The products can be fitted with special accessories. The installation, use and refurbishment of the connected accessories are described in detail in the respective manuals.

→ Only use original accessories.

→ Accessory part numbers: see **Accessories**.



WARNING

Hazard associated with non-compliant electrical installation

Safe operation after installation is the operator's responsibility.

→ Connect the product to an installation that is compliant with local safety standards.

→ Do not carry out any alterations or modifications to the product on your own initiative.

→ For specific questions, contact your service center.



WARNING

Electric shock hazard in case of contact

When the product's circuit breaker is set at **O**, some internal components still have an electrical charge.

→ Make sure that the mains connection is always visible and accessible so that it can be unplugged at any time.

→ Disconnect the power cable from all power sources before starting any work on the product.



WARNING

Risk associated with process gases

A leak detection operation must be carried out under environmental conditions that do not present any risks to the operator and the equipment. The user and/or integrator of the product are fully responsible for the operational safety conditions of the equipment. Therefore the user of the detector must:

→ not test parts or equipment with traces of harsh, chemical, corrosive, inflammable, reactive, toxic, or explosive substances, nor condensable vapours even in small amounts. Do not use the purge system to dilute these hazardous products: that is not what it is intended for!

→ apply specific safety instructions in accordance with local regulations. For more information, contact your service center.



CAUTION

Risk of pinching

When handling the storage tank cover, there is a risk of fingers becoming pinched.

→ Keep hands away from the sides when opening the cover.

→ Keep hands away from the front of the cover when closing it.



CAUTION

Risk of pinching

When handling the work surface cover, there is a risk of fingers becoming pinched.

- Keep hands away from the sides when handling the cover. Keep fingers away from the fastening latches when closing the cover and the work surface.



WARNING

Risk of injury in the event of a fall

Product should be removed from its packaging only by personnel qualified and trained in handling heavy materials.

- Ensure a space equivalent to the length of the detector is free in alignment with the access ramp.
- Always hold the detector by its handle to guide it and slow it on the access ramp.

The potential hazards concerning a leak detector involve electricity and the tracer gas.

- Only qualified personnel trained in safety rules (EMC, electrical safety, chemical pollution) may carry out the installation and maintenance described in this manual. Our service centers can provide the necessary training.
- Do not remove the blanked-off flange from the inlet port while the product is not in use.
- Do not expose any part of the human body to the vacuum.
- Comply with all safety and risk prevention instructions in accordance with local safety standards.
- Regularly check compliance with all precautionary measures.
- Do not turn on the product if the covers are not in place.

2.2 Protective equipment

In some situations, personal protective equipment must be worn when handling the detector and its components. Customers must provide operators with the necessary equipment. This equipment must be checked regularly and used in accordance with the supplier's recommendations.



WARNING

Risk of injury due to falling objects

When transporting parts/components and during maintenance there is a danger of loads slipping and falling down.

- Carry small and medium-size parts/components with both hands.
- Carry parts/components > 20 kg with a suitable lifting device.
- Wear safety shoes with a steel toe in accordance with directive EN 347.



WARNING

Risk of injury through hot surfaces

The products are designed so as not to present a thermal risk for the operator's safety. However, specific operating conditions may exist that require extra caution from users due to the high temperatures (surfaces > 70 °C for parts inside the covers).

- Leave the part to cool before working on the product.
- If necessary wear protective gloves according to directive EN 420.



2.3 Proper use



NOTICE

EC conformity

The manufacturer's declaration of conformity becomes invalid if the operator modifies the original product or installs additional components.

→ Following installation into a plant and before commissioning, the operator must check the entire system for compliance with the valid EU directives and reassess it accordingly.

- The leak detector is designed to detect and/or quantify a possible installation or component leak by searching for the presence of a tracer gas in the pumped gases.
- Only the tracer gases identified in this manual may be used.
- The product may be used in an industrial environment.

2.4 Improper use

Improper use will cause all claims for liability and warranties to be forfeited. Improper use is defined as usage for purposes deviating from those mentioned above, especially:

- pumping harsh, chemical, corrosive, inflammable, reactive, toxic or explosive fluids
- pumping of liquids
- pumping of condensing vapors
- pumping dust or solids
- operation in potentially explosive areas
- analysis of gas with a hydrogen concentration higher than 5 %
- testing parts that are soiled or that have traces of water, vapours, paint, adhesive, detergent or rinsing products
- use of accessories or spare parts, which are not named in this manual
- use of accessories or spare parts, which are not sold by the manufacturer

The product is not designed to carry people or loads and is not for use as a seat, step-ladder or any other similar purpose.

3 Transport and storage

3.1 Unpacking / repacking

Upon delivery, check that the product has not been damaged during transport. If the product is damaged, take the necessary measures with the carrier and notify the manufacturer. In all situations we recommend:

- Keeping the product in its original packaging so it stays as clean as it was when dispatched by us. Only unpack the product once it has arrived at the location where it will be used.
- Keeping the packaging (recyclable materials) in case the product needs to be transported or stored.
- Keeping the blanked-off plate on the inlet port when the product is not in use.

- Unpacking**
- Remove the box.
 - Remove the cover and the protective foam.
 - A foam ramp (1) attached to the pallet will unfold. This is used to remove the detector from the pallet.
 - Remove the box containing the accessories (*see 4.1.1*).
 - Release the brakes on the rear wheels of the detector.
 - Remove the detector from the transport pallet: slide the detector on the ramp (1), holding it by the handle to slow it down.

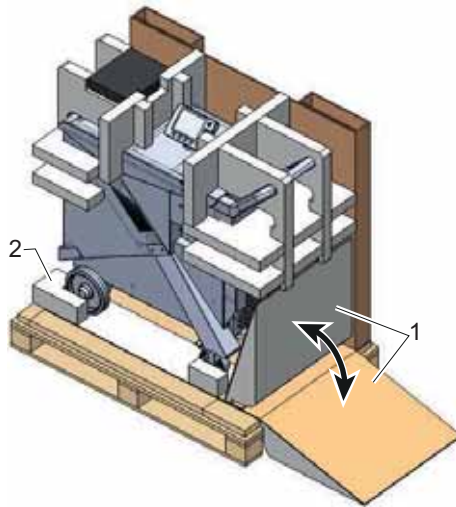

- Remove the yellow protective film from the front wheels.
- Remove the protective film from the control panel.

- Repacking**
- Check that the storage boxes are empty (*see 5.11*).
 - If the leak detector is fitted with accessories connected to the inlet port or any other customisation, remove them.
 - Install a blank-off flange on the inlet port.
 - If the leak detector is fitted with the bottle holder accessory, remove it and refit the handle in the initial position (*see bottle holder operating instructions*).
 - Place the detector on the transport pallet: slide the detector on the foam ramp (1) pushing it with the handle and immobilise the front of the detector against the foam stop (2) on the transport pallet.
 - Apply the brakes on the detector's rear wheels.
 - Fit the cover and the protective foam.
 - Lift the foam ramp (1) before putting on the cover.
 - Put on the box and strap the box and pallet.

When sending the detector to a service centre, keep the accessories delivered with the detector (see 4.1.1). Do not return them with the product.

3.2 Transport



WARNING

Risk of tipping over

Although the appliance meets EEC safety regulations (normal range $\pm 10^\circ$), it is advisable to guard against the risk of tilting during handling, installation, and use.

- Do not place the product on a plane with an incline greater than 3° (or 6%): its weight could cause the operator to be dragged.
- Use castors to move it.
- Place it on a flat, hard floor.
- Do not push it sideways or press on its side faces.
- Do not leave objects leaning on the side of it.



WARNING

Risk of injury in the event of a fall

Product should be removed from its packaging only by personnel qualified and trained in handling heavy materials.

- Ensure a space equivalent to the length of the detector is free in alignment with the access ramp.
- Always hold the detector by its handle to guide it and slow it on the access ramp.



NOTICE

Work/Handling the detector

The operator must not work on the product to move it or carry out maintenance until it has come to a complete shutdown! When the circuit breaker is set at **O**, you must:

- Unplug the power cable.
- Wait for the control panel screen to turn off completely before working on the product and/or removing the covers.

The product is not designed to carry people or loads and is not for use as a seat, step-ladder or any other similar purpose.

Move the product using the handle or the gripping area located at the front of the work surface.

Do not move the product using the bumper, the control panel (or its arm) or the inlet port.

3.3 Storage



NOTICE

Obligation to inform

We took care to provide you with a clean product. So that it stays clean, we recommend storing it in its original packaging.

Storing a new product



If a new detector must be stored:

- leave it in its packaging,
- leave the blanked-off flange in place on each port,
- store it in a clean, dry environment, in accordance with the temperature conditions specified in the **Technical Characteristics** (see 11.2).

Beyond 3 months, factors such as temperature, humidity, salt in the air, etc., could damage some components (elastomers, lubricants, etc.). If this happens, contact your service centre.

Extended storage

Recommended shutdown procedure before extended storage:

- Place the blanked-off flange on the inlet port.
- In the menu **[Test]**, check:
 - that the 'hard vacuum' test method is selected,
 - that the air inlet valve is set to 'Operator'
- Start a test by pressing : wait until the detector reaches the most sensitive test mode.
- Make sure that the inlet vent is inactive.
- Stop the test by pressing .
- Shut down the detector: circuit breaker  to **O**.
- Wait for the control panel turn off.
- Unplug the power cable.

In this way, the detector is under a vacuum, reducing the degassing time spent when it is switched on again.

4 Product description

4.1 Product identification

To correctly identify the product when communicating with Pfeiffer Vacuum, always have the information from the rating plate available.

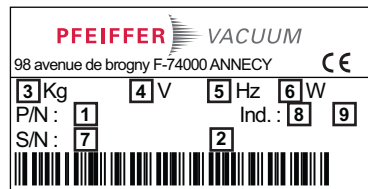

Fig. 1: Nameplate example

1	Part number
2	Description
3	Weight
4	Supply voltage
5	Supply frequency
6	Maximum power consumption
7	Serial number
8	Index
9	Date of manufacture

4.1.1 Scope of delivery

- 1 leak detector
- 1 documentation set (CD-ROM, operating instruction, plastic coated memos for the detector and the RS-232)
- 1 power cable for Europe (France/Germany) and/or 1 power cable for US
- 1 calibration certificate for the internal calibrated leak
- 1 maintenance kit
- 1 groundsheet (in the storage box)
- 1 batch of partitions for compartmentalisation (in the storage box)
- 1 Quality Control label
- 1 hose holder
- 1 adaptor for using the Smart sniffer probe
- 1 D-Sub male connector cover (15 or 37 pins, depending on option)
- 1 D-Sub male connector (15 or 37 pins, depending on option)

4.1.2 Variants

ASM 390-392 leak detectors are mobile, high-performance dry pumping detectors.

They are designed for applications for which ultra-cleanliness and a high pumping speed are essential (semiconductor, coating, etc.).

- ASM 390: with a tracer gas pumping speed of over 10 l/s, ASM 390 offers a fast response time.
- ASM 392: equipped with two turbomolecular pumps, ASM 392 offers the highest tracer gas pumping speed on the market in order to satisfy the needs of highly demanding applications.

4.2 Interface connection

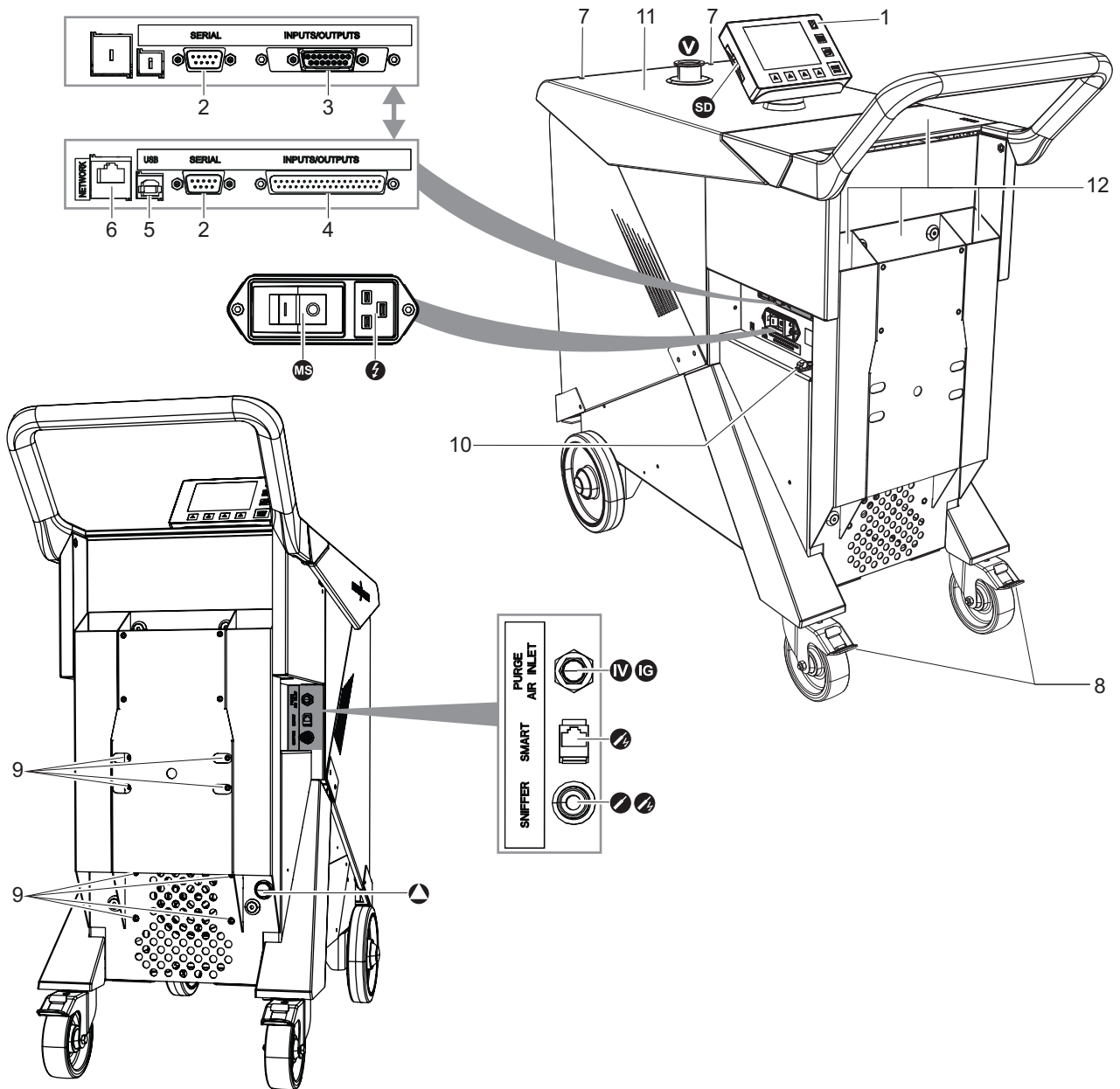

Fig. 2: Human-machine interface

⚡	Mains power supply	2	RS 232 connector D-Sub 9 pins (SERIAL)
V	Detector inlet (Inlet port)	3	Interface Connector- I/O D-Sub 15 pins (INPUTS / OUTPUTS) ⁽¹⁾
⬆	Primary pump Exhaust (EXHAUST)	4	Interface Connector- I/O D-Sub 37 pins (INPUTS / OUTPUTS) ⁽¹⁾
MS	Switch/Circuit breaker	5	USB plug (USB)
V	Inlet vent	6	Ethernet plug (NETWORK) ⁽¹⁾
IG	Gas inlet (purge)	7	Hose holder fixing point
SD	SD card	8	Brakes
⚡	Standard sniffer probe connection (STANDARD SNIFFER) ⁽²⁾	9	Bottle holder fixing point ⁽²⁾

Fig. 2: Human-machine interface

●	Smart sniffer probe connection (SMART SNIFFER) ⁽²⁾	10	Fastener for power cable safety
1	Standard remote control connector ⁽²⁾	11	Work plan
		12	Storage boxes

(1) Accessory or option (at the customer's expense)

(2) Accessory (at the customer's expense)

5 Installation

5.1 Prerequisites for optimising measurement

To optimise pumping and measurement speed:

- Use pipe with a diameter equal to the diameter of the detector's inlet. The pipes should be as short as possible and completely sealed.
- Do not use plastic hoses such as compressed air pipes.
- Check that the connected part/installation is impermeable to tracer gas.
- Test only clean, dry parts/installations with no trace of water, vapour, paint, detergent or rinsing products.
- Test that the entire line is completely sealed when the detector is attached to the pumping circuit, to ensure that the connections are correct (pump, pipe, valves, etc.).

5.2 Operating conditions



DANGER

Explosion hazard.

For detecting leaks with 'hydrogen' tracer gas, the operator must use hydrogenated nitrogen (mix of 95 % N₂ and 5 % H₂).



NOTICE

Risk of pollution from solid substances

When applications generate particles, we recommend protecting the detector's inlet.

→ Install a inlet filter (see **Accessories chapter**).



NOTICE

Detector ventilation

If there is insufficient ventilation, overheating could cause damage to the components:

→ Comply with the ambient operating temperature.

→ Do not obstruct the air vents.

→ Let a free space of 10 cm (4 inches) minimum all around the leak detector.

→ Store nothing under the detector.

Environmental conditions (see 11.2).

5.3 Set-up

The leak detector must be installed on a horizontal flat surface resting on its wheels.

WARNING

Immobilisation of the detector

The detector must be immobilised when it is being used or maintained.

→ Immobilise the leak detector by setting the brakes on the rear wheels.



NOTICE

Tracer gas concentration

You are advised to perform leak detection in a ventilated room.

5.4 Purge and inlet vent connection

The detector is equipped with an automatic purge optimizing the detector functioning.

- Inlet vent and purge are connected to the ambient air if no system is connected. Purge maintains air flow inside the leak detector.
- The inlet vent status (open or closed) depends on parameters set by the operator (see 7.4.6).

The connector of the purge and inlet vent is delivered equipped with a protection filter (see 4.2).

In addition to the purge, it is advised (not compulsor) to use the "Pollution" function (see 7.3.2).



CAUTION

Risk of pollution

The leak detector must not be used in an environment with strong concentration in tracer gas. The user has to make sure of the good ventilation on the place of use of the detector. The manufacturer shall not be held liable for any pollution of the product with tracer gas.

5.4.1 Connection

Instead of the protection filter, it is possible to connect the detector to a nitrogen line (at the customer's expense). To use nitrogen allows to decrease the background noise of the leak detector



WARNING

Pressurised circuit

To work safely on the product, the operator must:

- Install a manual valve on the nitrogen circuit at a distance of 3 m from the product, so that the nitrogen supply can be locked.

Flow To guarantee best performance, the nitrogen supply must be clean and filtered, with the following characteristics:

- relative excess pressure: 200 hPa
- flow rate: 5000 sccm (if pressure= 1 bar (absolute) at the inlet)

Usage pressure

- 0 to 0.3 bar relative (≈ 0 to 4.5 psig)
- 1.1 to 1.3 bar absolute (≈ 14.5 to 19 psig)

If the purge gas pressure is too high, the inlet valve could always be stay closed.

Procedure

- Remove the filter from the connector **IV** **IG** (see 4.2).
- Attach the nitrogen pipe to the connector **IV** **IG** (see 4.2).

5.5 Connection to the mains power supply



WARNING

Risk of electromagnetic disturbance

The product's EMC behavior is guaranteed only if the relevant EMC standards are followed during installation.

- Use shielded cables and connections for the interfaces in interference-prone environments.



WARNING



Hazard associated with non-compliant electrical installation

Safe operation after installation is the operator's responsibility.

- Connect the product to an installation that is compliant with local safety standards.
- Do not carry out any alterations or modifications to the product on your own initiative.
- For specific questions, contact your service center.



The leak detector is Class 1 equipment and therefore must be earthed.

5.6 Operating for the first time

- Attach the electrical network to the connector  using the power cable delivered with the detector.
- Set the circuit breaker  to I.
- Set the language, unit, time and date (the operator can modify this at a later time (see 7.7.1)).
- Wait for the detector to enter Stand-by mode.



5.6.1 Familiarise yourself with the control panel

Control panel description (see 6.1.1).

- Press  several times to familiarise yourself with the application screens.
- Press  several times to see the 2 levels of function keys available.
- For each level, press  or the control panel function key to access the function.

5.6.2 Become familiar with the detector

You can carry out a hard vacuum test and learn about your detector simply by performing a test on the equipment itself.

- Leave the blanked-off flange included with the product in place on the detector's inlet.
- Start a test by pressing . The measured leak rate is displayed: this is the detector's background.
- Stop the test by pressing .
- To remove the blanked-off flange from the detector's inlet, press **[Inlet vent]**.

5.7 Connecting the part/installation to be tested



NOTICE

Limit of operation

→ Make sure that the parts or chambers connected to the inlet of our products withstand a negative pressure of $1 \cdot 10^3$ hPa in relation to atmospheric pressure.

- The inlet pressure must be no higher than atmospheric pressure. Pressure that is too high can damage the product.
- The detector's performance depends on the type of accessories used and on the quality of the mechanical connections.
- When assembling the vacuum circuit, use accessories to shut off the product and make maintenance easier (inlet shut off valves, purge systems, etc.).
- Comply with these recommendations (see 5.1) to optimise measurement.
- The maximum permitted weight at the detector's inlet must be no more than 18 kg and the maximum torque must be 25 N·m.

- The total weight of the parts, accessories, etc. placed on the detector work surface must not exceed 50 kg.
- Connect the part or the equipment using a flexible pipe. Never use rigid pipe.
- Remove the blanked-off flange that covers the detector's inlet and save it for reuse during storage or transport.
- Connect the part or the equipment to be tested using the connection accessories available in the product catalogue.
- Test that the entire line is completely sealed when the detector is attached to the pumping circuit, to ensure that the connections are correct (pump, pipe, valves, etc.).

5.8 Connecting the exhaust

The detector exhaust must never be obstructed.

The leak detector is equipped with one of the following components at its exhaust (option/accessory):

- Metal filter
- DN 25 ISO-KF port
- DN 40 ISO-KF port

If degassing the customer application, you are advised to connect the detector exhaust to an exhaust line (at the customer's expense), ensuring that the detector is always used in compliance with the recommendations given (see 2.3).

The detector must always be compliant with its initial usage (see 2.3).



NOTICE

Limit of operation

- Ensure that the customer application exhaust line is always under slightly negative pressure.
- Make sure the exhaust pressure does not exceed 200 hPa (relative). Pressure that is too high can damage the product.

5.9 Control panel fixing



The control panel is magnetized so you can place it on any metallic surface.

5.10 Hose holder fixing

DN 40 ISO-KF hose holder (delivered alone without centring ring, o-ring and clamp) makes it possible to affix the hose connecting the inlet of the detector to the installation to be tested, during handling or extended storage, and to keep the inlet to the detector and the hose under vacuum.

The holder is fixed instead of a lifting ring.

- Place the hose holder on one of the 2 fixing points therefor.

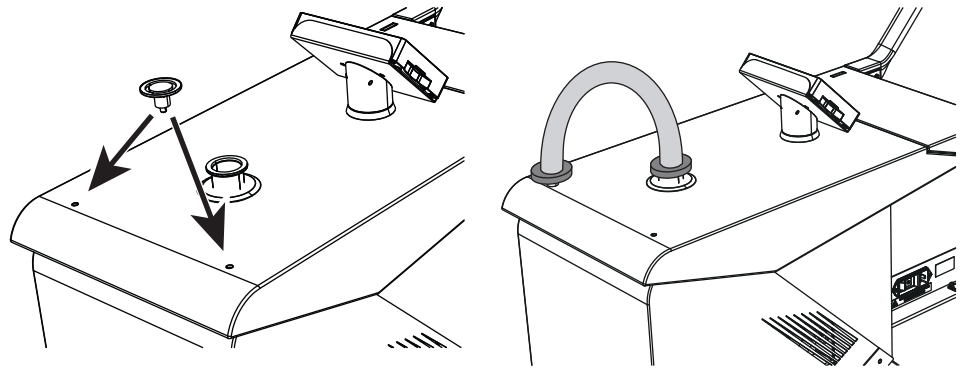

5.11 Storage

The leak detector has storage boxes, which one is lockable. The crosspieces kit delivered with the product allows to divide, in the suitability of the user, the storage box (1).

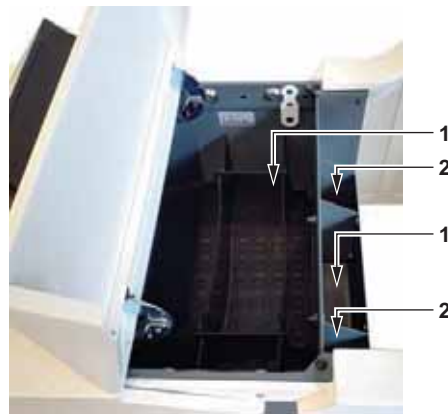

1	Hoses storage boxes
2	Storage boxes

Cover locking

It is possible to lock the access cover to one of the storage boxes with a padlock (padlock not delivered, at the customer's charge).

- Raise the leak detector cover.
- Unscrew the locking plate: turn it and screw it again.

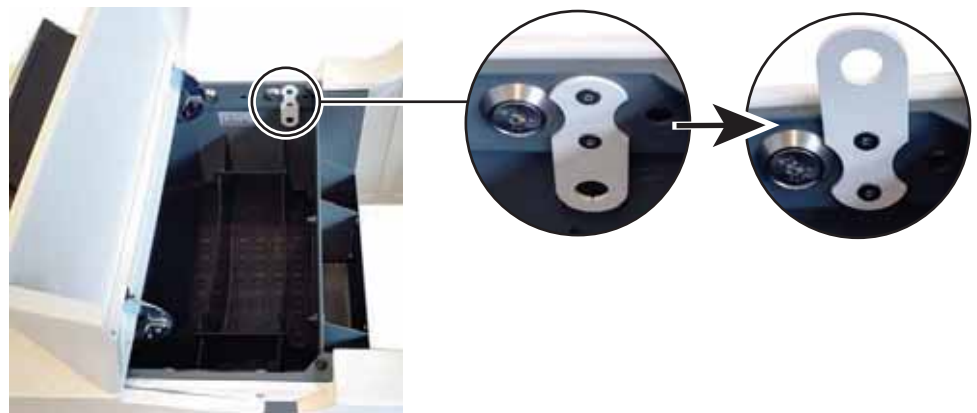

- Remove the path window of the locking plate with a small flat tool (screwdriver for example). Lower the cover. Attach a padlock.

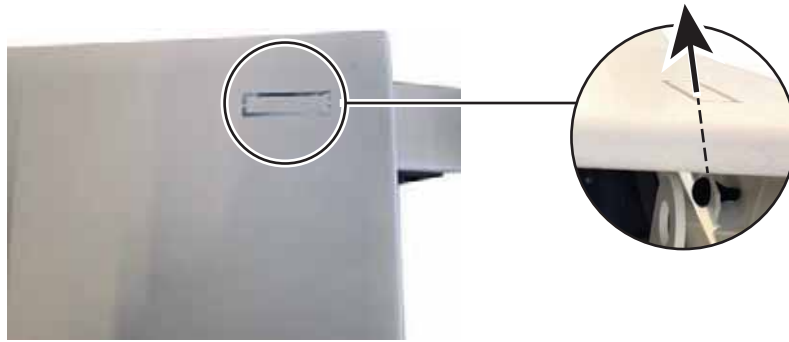

6 Operation

6.1 Control panel

It is interfaced with the detector and is used to:

- display information about the test
- access the available functions
- setting of the detector's parameters.



For a screenshot, set a function key to [Screen Copy] (see 7.7.2).



If the screen is out of order, functions remain accessible: use RS-232 to pilot/set the detector.

6.1.1 Description

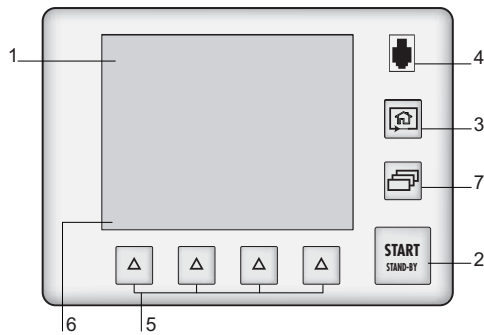

Fig. 3: Control panel

1	Application screens (touch screen): these are accessible or hidden (see 7.7.3).
2	Test Start/Stop.
3	Changing the application screens: return to the home page (standard screen) from any menu.
4	Standard remote control connection (accessory).
5	Quick access to the functions. Functions assigned to a key by the operator (provides access to the functions if there is a problem with the touch screen).
6	Displaying a function key level: starting the function or displaying a sub-menu by touching the screen.
7	Changing the level of function keys.

- ➔ Remove the film that protects the screen upon delivery.
- ➔ Use the touch screen manually without using hard objects such as pens, screwdrivers, etc.

	Function deactivated (OFF)
	Function activated (ON)
	Authorized access without password
	Access locked: access with password
	"Grey" key: access settings or function
	"White" key: key not customisable, for information
	"Measurement information" key: to display the measured leak rate
	Arrows for navigating within the menus

	Access to the error/warning window
	Value selected is customisable
	Keys for setting the values
	Moving to the next function/screen/parameter
	Return to the previous display
	Return to the previous display and confirm the changes made
	Return to the previous display without confirming the changes made
	Deleting the selected file

6.1.2 Contrast - Brightness - Screen Saver

(see 7.7.4)

6.1.3 Application screens

The content of the screens is given as an example. Depending on the leak detector and parameters, the display may be different.

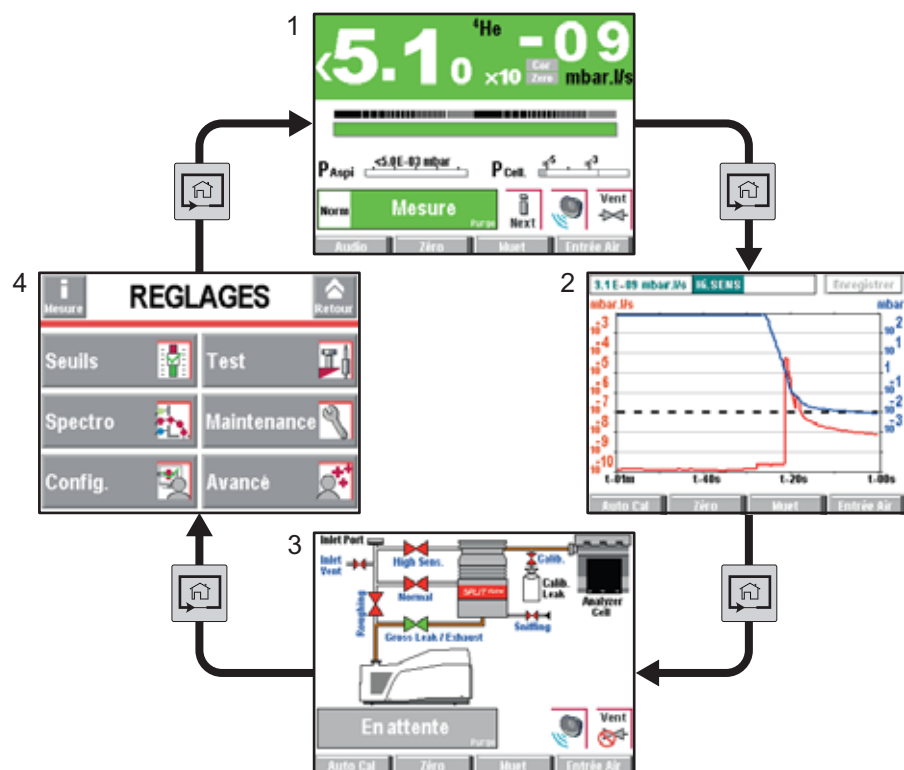

Fig. 4: Example of each screen

1	"Standard" screen (home) Information about the current test
2	"Graph" screen Monitoring and recording the leak rate and/or the inlet pressure
3	"Vacuum circuit" screen Vacuum circuit of the detector and the status of the valves

Fig. 4: Example of each screen

4 "Settings" screen
Detector parameters



The operator can hide and/or switch certain screens in the loop (see 7.7.3).

6.1.4 "Standard" screen

Information about the test.

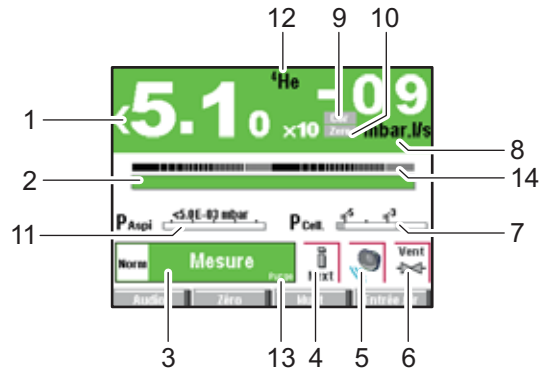

1	Digital display of the leak rate (green ≤ reject set point < red)
2	Bargraph display of the leak rate (adjustable scale)
3	Detector status and Detection mode
4	Access error information
5	Mute function indicator
6	Air inlet function indicator (except ASI 30/35)
7	Bargraph display of the cell pressure
8	Leak detector unit
9	Leak rate correction function indicator
10	Zero function indicator
11	Bargraph display of the detector inlet pressure (unit consistent with the leak rate unit)
12	Tracer gas (³ He, ⁴ He or H ₂)
13	Purge function indicator
14	Bargraph display of Zero function (2 decade)



A password can be used to lock access to the "Settings" menus while leaving certain functions accessible using the function keys (see 7.7.2).

6.1.5 "Settings" screen

(see 7.2)

6.1.6 "Graph" screen

(see 7.1)

6.1.7 "Vacuum circuit" screen

Vacuum circuit of the detector and the status of the valves.

Vacuum circuit is specific for each leak detector.

The vacuum circuit varies depending on the status of the valves, but does not make it possible to manage the valves.

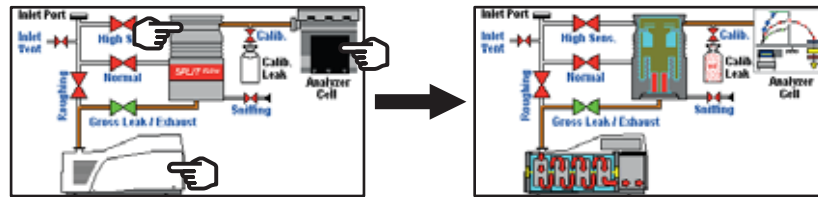

Fig. 5: Example

Red valve	Valve closed
Green valve	Valve open
Pumps, Analyzer cell	⇒ Press the component to display the operating principle.

6.1.8 "Measurement" window

- Press the **[Measure]** key to display the window.
- Press and drag the window to move it on the screen.

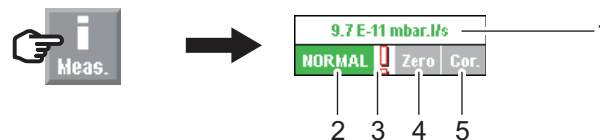

Fig. 6: **[Measure]** key and corresponding window

1	Digital display of the leak rate (green ≤ reject set point < red)
2	Detector test mode
3	Error information indicator
4	Zero function indicator
5	Leak rate correction function indicator

6.1.9 Function keys

The function keys are used to activate/stop a function or to set set points (see 7.7.2). Thanks to the function keys, it is possible to give the operator access to a limited number of functions.

6.2 Prerequisites to use

The leak detector is set to perform a hard vacuum test in the most sensitive test mode according to the initial settings (see 12.1).

For use with any other parameters or other functions, see **Chapter 7**.



NOTICE

Risk of seizing

→ Never move the detector when it is working.

Before each time the pump is switched on:

- Become familiar with the safety instructions (see 2).
- Check that all the connections are correct (see 5).
- Before use, make sure that the leak detector is in an environment free of tracer gas.
- Check that the electrical network is properly attached to the connector ⚡ using the power cable.

6.3 Switching the detector on

6.3.1 Switch on

→ Set the circuit breaker  to I (see 4.2).

The various stages for switching the detector on are displayed. The detector is ready for testing when the Stand-by screen appears.

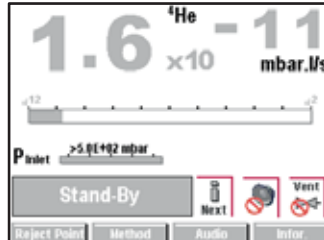

Fig. 7: Stand-by screen

Switching the detector on for the first time

(see 5.6)

Switching on after an extended shutdown

If the detector has been stored or has not been used, switching on time will be longer than if it is in regular use.

6.3.2 Starting a test

The test method is chosen depending on the part to be tested. For more information about leak detection test methods, see **Leak detector compendium** on the website www.pfeiffer-vacuum.com.

There are 2 possible test methods: hard vacuum or sniffing.

Hard vacuum test

→ Select the 'hard vacuum' test method (see 7.4.1).

→ Set the test mode (see 7.4.3).

→ Set the reject set point if necessary (see 7.3.3).

→ Set the detector to Stand-by mode.

→ Prepare the part to be tested.

- Spray method

- Remove the air from the part to be tested

- Connect the part to be tested to the leak detector inlet port.

- Bombing method

- Place the part to be tested in a pressurised gas tracer chamber.

- Remove the part to be tested from the chamber and place it in another vacuum chamber connected to the leak detector inlet port.

→ Start a test by pressing .

- Spray method

- Spray tracer gas on the points of the part that are likely to leak.

The various test stages are displayed.

→ When the detector has reached the most sensitive test mode, wait for the measurement to stabilise: the measurement displayed corresponds to the measured leak rate.

→ Stop the test by pressing .



The test can also be started using a remote control (accessory): see *Remote control Operating instructions*.



Sniffing test

→ Select the 'sniffing' test method (see 7.4.1).

→ Set the probe type used (see 7.4.4).

→ Set the reject set point **if necessary** (see 7.3.4).

→ With the leak detector in Stand-by mode, connect the sniffing probe (accessory) to the provided connector ( or ) and select Standard or Smart probe model (see 7.4.4).

- Start a test by pressing .
- Slowly scan, with the sniffer probe, the areas of the part to be tested with potential leak: the displayed leak rate varies in presence of a detected leak (qualitative value of the measured leak rate).
- Stop the test by pressing .

6.3.3 Test launched automatically upon start-up

This function is used to automatically launch the first test after the detector start-up phase.

- Ensure that the inlet is connected before starting the function.
- During the detector start-up phase, check the message displayed 'Run Test after start?' (1) then click on **[Yes]** (2) to enable the function.
 - The question will be asked each time the leak detector is switched on. The last selection made is not saved.
 - Click on **[No]** for the function not to be enabled.

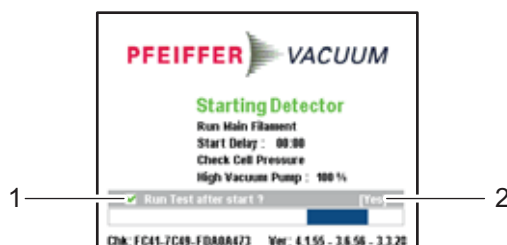

If the function is enabled, the first test starts automatically as soon as the detector start-up phase is completed. The following tests will be launched by the operator.

6.4 Monitoring operation

When the detector is in use, the operator is alerted to incidents as follows:

- Pictogramme display indicating that the error message should be read.
- Error display on the screen.

Message list: see **List of warnings/faults** in *Maintenance instructions*.

6.5 Shutdown the detector

- Set the circuit breaker  to **O** (see 4.2).
- Wait for the control panel screen to turn off completely before working on the product, removing the covers and/or moving it.

Shutdown due to a mains power failure When there is a mains power failure, the detector shuts down: it switches on again automatically when power is restored.

6.6 Saving and downloading the product's configuration

When a detector is installed or replaced, it is helpful to copy the configuration (all the parameters and operating set points programmed by the operator) of a detector that is the same model.

- Do this while the detector is switched on and in Stand-by mode.

6.6.1 Saving the configuration

- Follow the procedure for saving (see 7.8.13).

The detector's configuration will be saved on the SD card from control panel.

6.6.2 Downloading the configuration

→ Follow the procedure for downloading (see 7.8.13).

The previous configuration is automatically updated.

All the detector's parameters are downloaded except the following, which must be set by the operator:

- language
- serial link (except ASM 310)
- time and date
- temperature unit (except ASI 35)
- pressure unit.

6.7 Calibration

Calibration helps ensure that the leak detector is correctly adjusted to detect the tracer gas selected and display the correct leak rate. A calibrated leak is used to calibrate the leak detector.

Internal calibrated leak

The internal calibrated leak is specifically designed for the leak detector. It is composed of:

- a Helium 4 reservoir (no internal calibration with the other tracer gases),
- a temperature sensor (to take into account the effect of temperature on the leak rate),
- an integrated diaphragm (to calibrate the leak rate),
- an identification label (identical to the identification label of an external calibrated leak).

The calibrated leak is supplied with a calibration certificate.

Use a calibrated leak in the range $\approx 10^{-7}$ mbar-l/s ($\approx 10^{-8}$ Pa.m³/s).

External calibrated leak

The operator must use a calibrated leak containing the tracer gas selected (⁴He, ³He or H₂). There are several types of external calibrated leaks, with or without reservoir, with or without valve, covering several leak ranges

Consult us for the choice of the leak.

The manufacturer does not provide calibrated leaks in ³He and H₂.



The choice of external calibrated leak depends on the needs of the application: use a calibrated leak from the same leak rate range as the leak to be measured.

6.7.1 Calibration in Hard Vacuum test

Calibration with the internal calibrated leak

Internal calibrated leak (see 6.7).

The calibration can begin when the detector is in test mode.

- Check the leak settings (corrected leak rate to take temperature and time into account if necessary) (see *Spectro Menu of the Operating Instructions*).
- Press [**Auto cal**] key to launch a calibration.



NOTICE

Detector calibration

20 minutes after the switched on, the detector suggests that the operator carry out an auto-calibration (if calibration parameter = 'operator'). For the correct use of the detector, **this auto-calibration must be performed**. In all situations, a calibration must be performed:

- at least once a day
- to optimise the measurement reliability for high sensitivity tests
- if it is uncertain whether the detector is working properly
- during intense and continuous operation: start an internal calibration at the beginning of each work session (e.g. work in teams, every 8 hours).

Calibration with the external calibrated leak

External calibrated leak (see 6.7).

- Configure the following settings:
 - test method = hard Vacuum (see **Test Menu**)
 - type of calibrated leak = external (see **Spectro Menu**)
 - calibration = operator (see **Advanced Menu**)
- Check the settings and value of the external calibrated leak used (see **Spectro Menu**). Correct the temperature, month and year if necessary.
- Select the tracer gas of the external calibrated leak (see **Spectro Menu**).
- Place the external calibrated leak on the detector inlet port.
- Verify that the detector is on Stand-by mode.
- Press the **[Auto.Cal]** function key to start the calibration.
- Follow the instructions provided by the leak detector: press **[Next]** to move to the next stage.

At the end of the calibration, the detector returns to Stand-by mode.



Recommended procedure when the reject point is far from the value of the internal calibrated leak.

Adaptor for external calibrated leaks:

A DN 16 ISO-KF or DN 25 ISO-KF adaptor helps calibrate the detector with an external calibrated leak in sniffing test mode (with Standard probe only).

Adaptor part numbers (see **Maintenance instructions**).

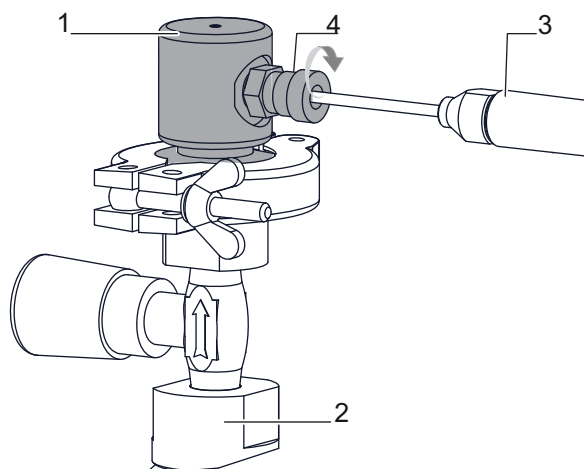

Fig. 8: Adaptor installation

- Attach the adaptor (1) to the external calibrated leak (2) used for the calibration with centering ring and a clamp.
- Start a calibration: press the **[Auto cal]** function key.

- Fit the sniffer probe (3) in the calibration opening.
- Tighten the fixing screw (4). Follow the calibration process indicated on the control panel.
- Loosen the fixing screw (4).
- Remove the sniffer probe from the calibration opening.
- Continue the calibration process indicated on the control panel.
- Wait 10 s (at least) before reading the leak rate.

Calibration with a pumping system in parallel

When the leak detector is connected to an installation equipped with its own pumping system, only part of the leak will be measured by the leak detector. Calibration gives a direct reading of the leak rate by taking into account the loss of tracer gas of the leak pumped by the pumping unit.

Calibration is performed via the Correction function ('Autocor').

Correction must be performed when the leak detector is already calibrated with its internal calibrated leak.

When an external calibrated leak is used, it is recommended to take into account the calibration date and temperature effect for calculating the target value from the calibrated leak value featured on its identification label.

Corrected leak rate = target value = measured leak value x correction factor.

- Allocate a **[Correction]** function key (see *Configuration Menu in the Operating Manual*).
- Select the 'hard vacuum' mode.
- Press  to start a test.
- Press the **[Correction]** function key.
 - if the value of the correction factor to be applied is known:
 - Press **[Value]** and configure the correction factor to be applied. The correction factor is the coefficient to be applied to the measured leak rate.
 - Press **[Return]** to exit the function.
 - if the value of the correction factor to be applied is unknown:
 - Press **[Auto Cor] [Target]** and configure the target leak rate.
 - Press **[Start]** to make the correction.
 - Press **[Return]** to exit the function.

The value of the correction factor is automatically calculated.

The '**COR**' indicator light (see *Standard screen of the Operating Manual, Rep 9*) is illuminated on the control panel as soon as the value of the correction factor is not 1.

The digital display takes into account the correction factor applied.

The bargraph display does not take into account the correction factor applied.

- Press **[RAZ]** to reset the correction factor to 1.

6.7.2 Calibration in Sniffing test

Calibration with the internal calibrated leak

Internal calibrated leak (see 6.7).

The calibration can begin when the detector is in Stand-by.

This calibration calibrates only the detector, not the whole chain of measurement (detector + sniffer probe).

Identical procedure that in vacuum test (see 6.7.1).

Calibration with the 'Sniffer externe' calibrated leak

External calibrated leak (see 6.7).

- Configure the following settings:
 - test method = sniffing (see *Test Menu*)
 - type of calibrated leak = Sniffer externe (see *Spectro Menu*)
- Select the tracer gas of the external calibrated leak (see *Spectro Menu*).

- Check the settings and value of the external calibrated leak used (see **Spectro Menu**). Correct the temperature, month and year if necessary.
- Select the tracer gas of the concentration (see **Spectro Menu**).
- Press the **[Auto.Cal]** function key to start the calibration.
- Follow the instructions provided by the leak detector: press **[Next]** to move to the next stage.

Calibration on concentration

Concentration = container at atmospheric pressure with a gas mixture of a known tracer gas concentration.

The calibration on concentration can be made only in sniffing test, detector in Stand-by.



NOTICE

Before launching this function, make sure that the leak detector is in an environment free of tracer gas pollution.

- Configure the following settings:
 - test method = sniffing (see **Test Menu**)
 - type of calibrated leak = concentration (see **Spectro Menu**)
 - calibration = operator (see **Advanced Menu**)
- Select the tracer gas of the concentration (see **Spectro Menu**).
- Press the **[Auto.Cal]** function key to start the calibration.
- Follow the instructions provided by the leak detector: press **[Next]** to move to the next stage.

At the end of the calibration, the detector returns to Stand-by mode.

7 Advanced settings

7.1 "Graph" screen

→ Access the "Graph" screen by pressing .

7.1.1 Description

Monitoring and recording the leak rate and/or the inlet pressure.

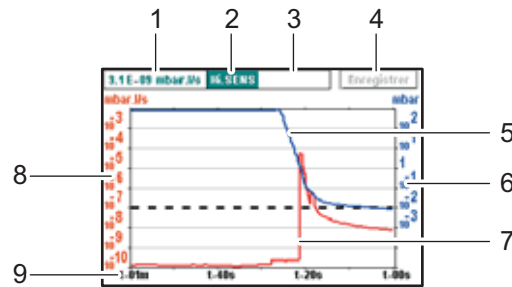

Fig. 9: "Graph" screen

1	Digital leak rate display
2	Detector status and detection mode
3	Indicators of the functions 'Leak rate correction' and 'Zero'
4	Plot recording
5	Inlet pressure plot (in blue)
6	Inlet pressure scale (in blue)
7	Plot of the tracer gas leak rate (in red)
8	Scale of the tracer gas leak rate (in red)
9	Time scale

Scales (6), (8), (9) are adjustable by pressing the graph.

7.1.2 Settings

→ Access the graph settings menu by pressing the graph.

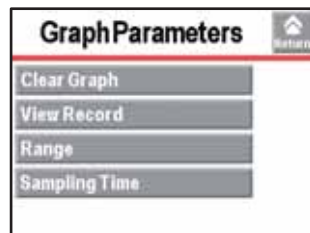

7.1.3 Scales setting

→ Press on the graph and on [Scale] to change the graph parameters.

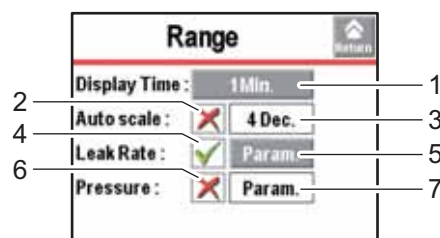

1	Period of time displayed on the screen
2	Activating/Deactivating the automatic scale
3	Setting the automatic scale

4	Displaying/Hiding the measured leak rate
5	Setting the leak rate scale (If 'automatic' scale is deactivated)
6	Displaying/Hiding the inlet pressure
7	Setting the inlet pressure scale

Automatic scale

The automatic scale is used to display the measured leak rate centred on 2 or 4 decades. The scale varies according to the leak rate measured. When the automatic scale is activated, the scales set for the leak rate and pressure are no longer taken into account.

Example: leak rate = $5 \cdot 10^{-7}$ mbar·l/s ($5 \cdot 10^{-8}$ Pa·m³/s)

- automatic scale 2 decades: scale from $1 \cdot 10^{-6}$ to $1 \cdot 10^{-8}$ mbar·l/s ($1 \cdot 10^{-7}$ to $1 \cdot 10^{-9}$ Pa·m³/s)
- automatic scale 4 decades: scale from $1 \cdot 10^{-5}$ to $1 \cdot 10^{-9}$ mbar·l/s ($1 \cdot 10^{-6}$ to $1 \cdot 10^{-10}$ Pa·m³/s)

7.1.4 Graph clearing**Current window**

- Press on the screen and **[Clear Graph]**.
- Validate the message.

Clearing the current window does not delete the current recording or recordings already made.

Recording

- Press on the screen and **[View Rec.]**.
- Press **[Clear]**.
- Validate the message.

7.1.5 Recording

Recording makes it possible to store the measurements taken during the test in the control panel memory: **it will not save these measurements** (see 7.1.6).

During a recording, all the detector functions are available.

After the detector is switched off (cut off at the mains or by the operator), the recordings already made are stored in the memory. For the next recording, the operator will have to specify:

- if the new recording is to be added to the recordings in the memory **[OK]**
- if the new recording is to delete or replace the recordings in the memory **[Cancel]**.

- Press on the graph and **[Record]** to change recording parameters.
- Press on the graph and **[Scale]** to change graph parameters.
- Press **[Record]** (4) (see 7.1.1) to start recording

None of the measurements displayed on the plot before the recording starts will be recorded.

- Press **[Stop Rec.]** (4) (see 7.1.1) to stop recording.
- Press on the graph and **[View Rec.]** to see the recording.

If the memory is not cleared between two recordings (**[Clear]** (see 7.1.4)), all subsequent recordings will appear consecutively on the same memorised plot. A ▲ cursor indicates the end of each recording.

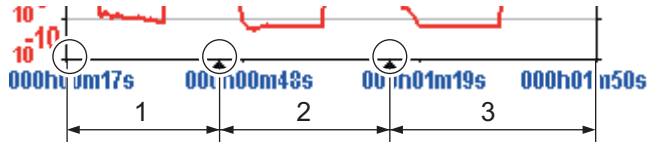
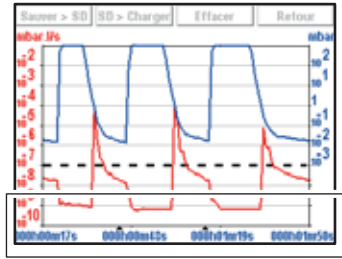

Fig. 10: Recording example

- 1 1st recording
- 2 2nd recording
- 3 3rd recording

When the memory is full and if a recording is in progress, recording is automatically stopped.

The **[Record]** key is replaced by the **[Mem full]**.

Recording → Press **[Recording]**.

Duration	Recording duration
Capacity	Total recording time according to recording duration
Duration	Maximum capacity
0.2 s (min.)	6 hours 33 minutes
30 s (max.)	983 hours
	File size
	≈ 7 Mo

7.1.6 Saving a recording

This function is used to save the most recent recording on a SD card to be played back/analysed later on a PC. Saving is not automatic.

It is possible to save a screenshot of the recording (.bmp) or to generate a file (.txt) with all the measurements taken. The .txt file allows a later processing: the default separator is "tab"

- Press on the screen and **[View Rec.]**.
- Select the file type and press **[Save > SD]** (see 7.1.5).
- Name the file and save it

The saved .bmp and .txt files include only the measurement points displayed on the screen:

- to include all points, you must be positioned on the relevant plot (without zooming).
- if a zoom was carried out before saving, the zoom will apply only to the points of the selected zone.

If the saved recording is made up of several consecutive recordings:

- the ▲ cursor will indicate each new recording on the .bmp files.
- "B.P. # xx" will be noted at the end of the last line of each recording in the .txt files.

.bmp files can be displayed on the control panel screen.

.txt files can be opened only from a PC: no possible reading from the control panel.

7.1.7 Viewing a recording



At any time, the operator can view the recording already made or zoom in on a recording, without stopping the current recording.

→ Press on the screen and **[View Rec.]** to view the recording made since the last recording was deleted (1) (see 7.1.1).

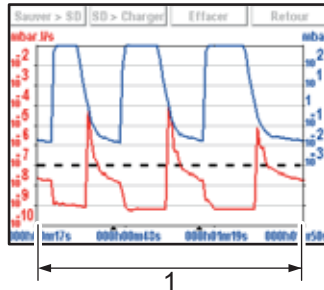

Fig. 11: Viewing a recording

1 | Total recording time

If no plots have been made, the message "Memory empty" is displayed.

Zoom in Zoom in available only for a recording.

→ Press on the graph and **[View Rec.]** (see 7.1.1).

→ Set the area to be enlarged ((1) then (2)).

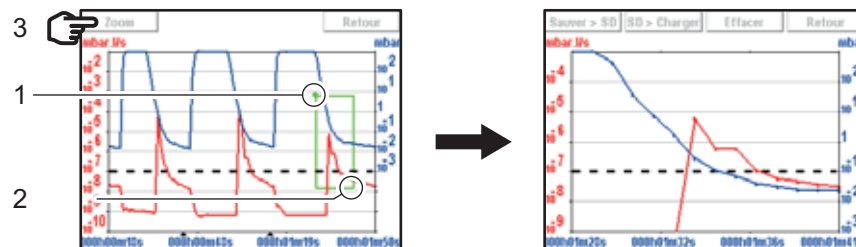

Fig. 12: Selection and viewing the area to be enlarged

→ Press **[Zoom]** (3): the enlarged area is displayed.

Several successive zooms are possible (except in the same decade).



If necessary, adjust the area to be enlarged by dragging the corners or sides with your finger.

Zoom out Zoom out available only for a recording.

→ Press on 2 occasions on the zoom ((1) then (2)) to return to the original graph.

– The point (2) always has to be situated before the point (1): see example below.

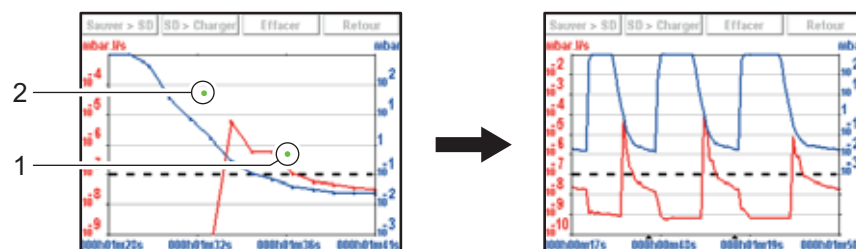

Fig. 13: Return to the original graph

Measurement Exact measurement of a point only available on a recording.

→ Select the point to measure (2).

→ Press **[Measure]**: the exact measurement of the selected point is displayed.

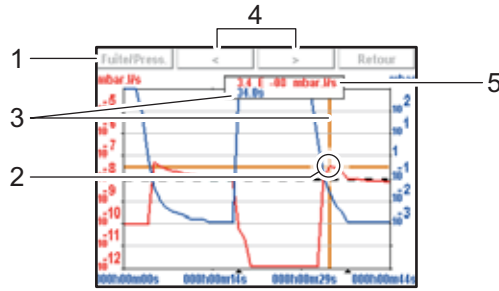

Fig. 14: Exact measurement of the selected point

1	Selecting the display of the leak rate or the inlet pressure
2	Marker indicating the selected point
3	Moment the measurement took place in relation to the start of the recording
4	Navigation between next/previous recorded points
5	Displaying the tracer gas leak rate (in red) or the inlet pressure (in blue)



To make the exact values of all measurements available on any type of spreadsheet, save the recording to a .txt file.

7.2 Settings

Screen for accessing the detector's settings menus to set the detector according the application. After this, for daily operation the functions keys will be used.

The "Settings" menu is accessible from any screen by pressing 2 keys + on the control panel simultaneously.

Access to the various menus can be locked (see 7.7.5).

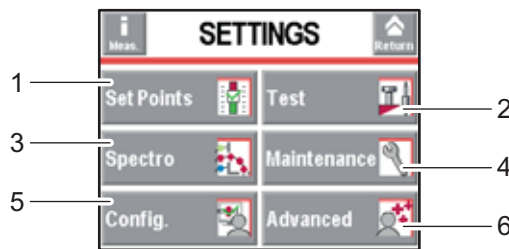

1	Setting the set points: reject set point, audio level, digital voice, pollution.
2	Method and test mode selection. Inlet vent management. Correction value. Cycle end.
3	Tracer gas selection. Setting the calibrated leak.
4	Scheduling maintenance. Detector information
5	Detector setting for the operator: language, unit, password, function keys, application screens.
6	Advanced functions* reserved for specific detector uses.

Table 1: * advanced settings requiring substantial knowledge about leak detection: pressure gauge, etc.

7.2.1 Tree diagram of the "Settings" menus

(see 12.1)

7.3 Set points Menu

→ From the "Settings" screen, press [Set points] to access the menu.

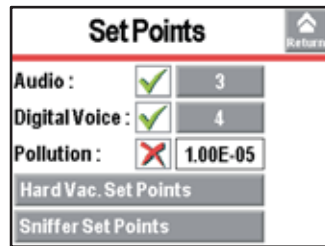

7.3.1 Audio alarm and digital voice

Audio alarm The audio alarm informs the operator that the reject set point has been crossed. The level varies from 0 to 9 (0 to 100 dB (A)).

From the "Settings" screen, press [Set points].

Audio	⇒ Activate the audio level.
	⇒ Set the audio level.



For quick access from the control panel, set a function key to [Audio] (see 7.7.2).



Fig. 15: "Audio" screen using a function key

Digital voice Digital voice informs the operator about the status of the detector or actions to be carried out.

From the "Settings" screen, press [Set points].

Digital voice	⇒ Activate digital voice.
	⇒ Set the digital voice level.



For quick access from the control panel, set a function key for [Voice] (see 7.7.2).



Fig. 16: "Voice" screen using a function key

"Mute" function → Stop the audio alarm and the digital voice at the same time with the [Mute].

7.3.2 Pollution function

This is a safety device for the detector. It prevents too much leaked tracer gas from penetrating the detector. We recommend setting the pollution set point to a maximum of 4 decades above the reject set point. If the leak rate rapidly increases above the pollution set point, the cycle stops automatically and the leak detector returns to Stand-by mode.

From the "Settings" screen, press [Set points].

Pollution	⇒ Activate the function.
	⇒ Set the application set point.



Useful function if the part or installation to be tested is likely to have gross leaks.

7.3.3 Hard Vacuum reject point

The hard vacuum reject point defines the acceptance set point for parts that are "accepted/rejected" in a hard vacuum test:

- Measured leak rate \leq reject set point: part accepted
- Measured leak rate $>$ reject set point: part rejected

From the "Settings" screen, press [Set points] [Hard Vacuum set points].	
Reject point	⇒ Set the reject point value.

The reject set point is memorized for each configurable tracer gas.



For quick access from the control panel, set a function key for [Reject Point] (see 7.7.2).
--

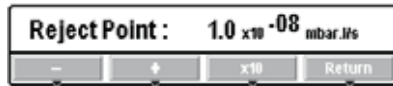

Fig. 17: "Reject point" screen using a function key.

7.3.4 Sniffing reject set point

The sniffing reject set point defines the acceptance set point for parts that are "accepted/rejected" in a sniffing test:

- Measured leak rate ≤ reject set point: part accepted
- Measured leak rate > reject set point: part rejected.

From the "Settings" screen, press [Set Points] [Sniffing Set Points].	
Reject point	⇒ Set the set point value.



For quick access from the control panel, set a function key for [Reject Set Point] (see 7.7.2) and (see 7.3.3).
--

7.3.5 Probe clogged set point

The purpose of this set point is to check that the sniffer probe (accessory) is operational. When the measured leak rate is lower than the set 'probe clogged' set point, the operator receives a message to check the probe (See **Sniffer probe Operating instructions**).

From the "Settings" screen, press [Set Points] [Sniffing Set Points].	
Probe clogged	⇒ Set the set point value.

- With the Standard sniffer probe, the set point unit is the unit set for the detector.
 - With the Smart sniffer probe, the set point unit is always 'scm'.
- ➔ Block the end of the sniffer probe from time to time with your finger to check that the leak rate is going down. If not, the probe may be clogged or drilled. Do not block the end for too long: if it is the case, a error message displays.

7.3.6 Other Set points

Prerequisite: detector equipped with the 37 pin I/O board (option/accessory).
 4 hard vacuum reject points can be set and controlled by the I/O (see **I/O 37-pin** operating instructions).

From the "Settings" screen, press [Set Points] [Additional Set Points].	
Set point #	4 additional reject points available with the 37 pin I/O board. ⇒ Adjust the set point value.

7.3.7 Other Pressure set point

Prerequisite: detector equipped with the 37 pin I/O board (option/accessory).
 If the installation is equipped with an external gauge (at the customer's expense), two pressure set points can be set and controlled by the I/O (see **I/O 37-pin** operating instructions).

From the "Settings" screen, press [Set Points] [Additional Pressure Set Point].	
Pressure Set Point #	⇒ Adjust the set point value.

7.4 “Test” Menu

→ From the "Settings" screen, press [Test].

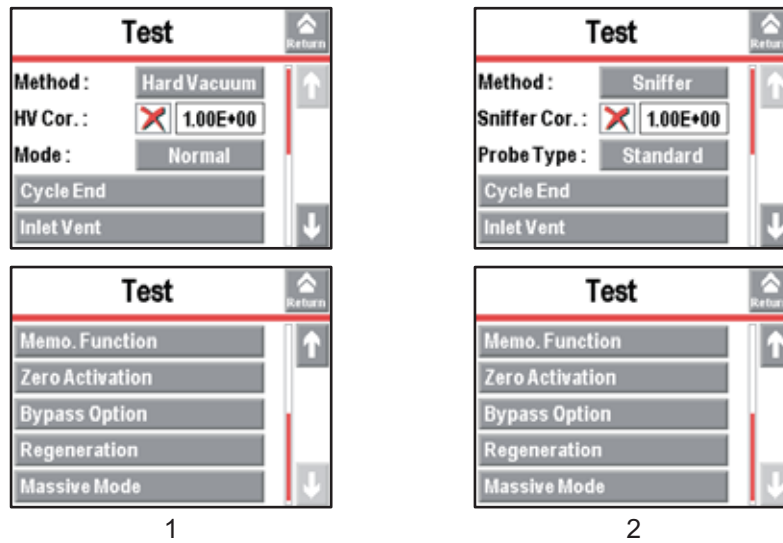

Fig. 18: Hard vacuum test 1 and sniffing test 2 menu

7.4.1 Test methods

The test method is chosen depending on the part to be tested. For more information about leak detection test methods, see *Leak detector compendium* on the website www.pfeiffer-vacuum.com.

There are 2 possible test methods:

- hard vacuum test,
- sniffing test.

From the "Settings" screen, press [Test].

Method ⇨ Select the test method.



NOTICE

Limit of operation

→ Make sure that the parts or chambers connected to the inlet of our products withstand a negative pressure of $1 \cdot 10^3$ hPa in relation to atmospheric pressure.



For quick access from the control panel, set a function key for [Method] (see 7.7.4).

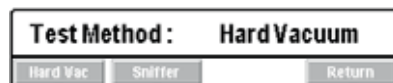

Fig. 19: "Method" screen using a function key

7.4.2 Correction factor

The correction factor allows correction of the measured leak rate by the detector:

- when it is combined with parallel pumping
- when the concentration of the used tracer gas is lower 100%.

From the "Settings" screen, press [Test].

HV Correction/Sniff. Correction	⇒ Activate the correction factor application. ⇒ Set the correction factor to be applied, if known. ⇒ If it is not known, using the [Correction] function keyclick on [Auto Cor]: calculation of the correction factor to be applied and automatic application.
---------------------------------	--



For quick access from the control panel, set a function key for [Correction] (see 7.7.2).



Fig. 20: "Correction" screen using a function key



Depending on the concentration of tracer gas used for detecting leaks, the leak rate displayed changes.

E.g. the leak rate displayed with a calibrated leak of $1 \cdot 10^{-7}$ mbar·l/s ($1 \cdot 10^{-8}$ Pa·m³/s) (with 100 % ⁴He) connected to the detector's inlet.

% He in the gas used	100 %	50 %	5 %	1%
Leak rate displayed on the leak detector without correction	$1 \cdot 10^{-8}$ Pa·m ³ /s $1 \cdot 10^{-7}$ mbar·l/s	$5 \cdot 10^{-9}$ Pa·m ³ /s $5 \cdot 10^{-8}$ mbar·l/s	$5 \cdot 10^{-10}$ Pa·m ³ /s $5 \cdot 10^{-9}$ mbar·l/s	$1 \cdot 10^{-10}$ Pa·m ³ /s $1 \cdot 10^{-9}$ mbar·l/s
Correction value	1	2	20	100
Leak rate displayed on the leak detector with correction	$1 \cdot 10^{-8}$ Pa·m ³ /s $1 \cdot 10^{-7}$ mbar·l/s			

7.4.3 Test mode

A hard vacuum test can be performed as soon as one of the test modes is reached. The leak detector will automatically switch to the test mode selected when the internal pressure reaches the crossover threshold (see 7.8.4).



For quick access from the control panel, set a function key for [Mode] (see 7.7.2).



Fig. 21: "Mode" screen using a function key



By default, the leak detector is set to work in a hard vacuum test, in the most sensitive test mode: this setting meets the majority of the operators' needs.

From the "Settings" screen, press [Test].

Mode	⇒ Set the test mode.
------	----------------------

7.4.4 Type of probe

A sniffer probe (accessory (see 10)) must be connected in order to work in sniffing. 2 models available: Standard probe (**model with rigid nipple only**) and Smart probe.

From the "Settings" screen, press [Test].

Probe type	⇒ Set the probe model used.
------------	-----------------------------

See also Probe clogged set point (see 7.3.5).

7.4.5 Automatic Cycle End

This function allows automatic control of the roughing time and measurement time in a hard vacuum test.

From the "Settings" screen, press [Test] [Cycle End].

Automatic cycle end	⇒ Activate the function. Function activated if 'automatic' is set.
Roughing timer	Setting optional if 'automatic' is set. ⇒ Activate the control for the roughing duration. ⇒ Set the maximum roughing duration allowed. If the control is activated and the duration expires (detector still in roughing) = part rejected.
Test timer	Setting required if 'automatic' is set. ⇒ Set the measurement duration. When the duration expires, the measured leak rate is displayed.

**Function to use to automate small production.****7.4.6 Inlet vent**

This function allows an inlet vent after a hard vacuum test stop.

It allows the detector's inlet, and therefore the connected part or installation, to return to atmospheric pressure.

This function is secure: a confirmation message "Inlet vent? Please confirm." appears each time the operator requests an inlet vent.

From the "Settings" screen, press [Test] [Inlet vent].

Inlet vent	⇒ Activate the function. Function activated if 'automatic' is set.
Delay	Setting required if 'automatic' is set. ⇒ Set the delay. Delay = time between the test stop and the automatic opening of the inlet vent valve. Allows a controlled valve to be closed before inlet vent.
Vent Timer	Setting optional if 'automatic' is set. ⇒ Activate the closing of the inlet vent valve. ⇒ Set the duration. Duration = time between the opening of the air inlet valve and its automatic closing. The automatic closing after a set duration is used to limit consumption of dry air or nitrogen, if purge is connected.

**For quick access from the control panel, set a function key for [Inlet Vent] (see 7.7.2).**

Activate VENT ? Please confirm.

Ok

Return

Fig. 22: "Activate vent" screen using a function key

If "Automatic" is selected, air enters automatically when  is pressed to stop the test.

If 'Operator' is selected, press the corresponding function key to return the detector to atmospheric pressure.

Inlet vent manual activation from:

- the button **[Inlet vent]**
- the "Standard" screen (6) (see 6.1.4).



To lock the control for the inlet vent valve, delete the [Inlet vent] function key. The icon stays on the "Standard" screen as an indicator but manual activation by the operator will be deactivated.

**NOTICE****Automatic inlet vent**

Never programme 'automatic' inlet vent while the detector is connected to a high vacuum chamber or semi-conductor process chamber!

Select 'Operator' and/or delete the function key allocated to the automatic inlet vent. The inlet vent must be carried out using the menu, which can be password locked.



By connecting an inlet vent (or nitrogen) line to the inlet vent, the detector's tracer gas pollution is reduced.

7.4.7 Memo function

At the test stop, this function freezes the "Standard" screen with the leak rate measured during this test: the latest leak rate measured during the test displays and flashes.

From the "Settings" screen, press [Test] [Memo Function].

Active	⇒ Activate the function.
Display time	Setting required if the function is active. ⇒ Activate the display time delay. <ul style="list-style-type: none"> • On = the value of the measured leak rate flashes for the set duration. • Off = the value of the measured leak rate will flash until a new test begins. ⇒ Set the display duration.



For quick access from the control panel, set a function key for [Memo] (see 7.7.2).

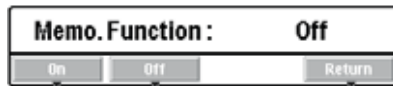

Fig. 23: "Memo function" screen using a function key

7.4.8 Zero activation

This function is used to help the operator identify very small leak rate variations in the surrounding background or to dilate small measured leak rate fluctuations on the analogical display.

From the "Settings" screen, press [Test] [Zero Activation].

Activation	⇒ Activate the function (activated if 'automatic' is set).
Zero Exit	Setting required if 'operator' is set. ⇒ Set the type of keystroke for exiting the function (see below).
Trigger	Setting required if 'automatic' is set. ⇒ Set the function trigger factor.
Value	Setting required if 'automatic' is set. ⇒ Set the function trigger value.



To launch the function manually from the control panel, set a function key to [Zero] (see 7.7.2).

→ To activate the function manually, press the [Zero].

- Press once: activate/deactivate zero by quickly pressing the [Zero] function key.
- Press > 3 s:
 - activation: quickly press the [Zero] function key. Each time the key is pressed quickly, a new zero is carried out.
 - deactivation: press > 3 s the [Zero] function key.



Using this function is recommended when the background of the tracer gas is stable. This function is used to measure a leak rate that is lower:
 - 2 decades in hard vacuum test mode: $1 \cdot 10^{-12}$ mbar·l/s ($1 \cdot 10^{-13}$ Pa·m³/s) minimum
 - 3 decades in sniffing mode: $5 \cdot 10^{-9}$ mbar·l/s ($5 \cdot 10^{-10}$ Pa·m³/s) minimum
than the detector's background when the detector is no longer in roughing.

Zero function activated, a 2 decades bargraph displays on the standard screen (see 6.1.4).

7.4.9 Bypass Option

Prerequisites:

- Detector with the 37 pin I/O board (option/accessory)
- Bypass kit (accessory) and its Bypass pump (at customer's expense), connected to the detector
- DN 25/DN 40 ISO-KF adaptor (at customer's expense)

For more information about the Bypass and installing it on the leak detector, see the **Operating instructions** included with the kit.

➔ From the "Settings" screen, press **[Advanced] [I/O Connector] [Quick View]** and check that the following inputs/outputs are set (initial settings):

Setting required for using the Bypass

- Digital Input 32 – Ground = Bypass option
- Digital Transistor Output 9 – 28 = Bypass

➔ If set otherwise, set like this: see **37 pin I/O board Operating instructions**.

Press [Test] [Bypass Option].

Mode	None = External Bypass pump installed but not active Quick pump = External Bypass pump active only during roughing Partial flow = External Bypass pump active during roughing and test + leak rate correction to be applied
Evac. Delay	On = roughing only via the external Bypass pump. Off = roughing via the external Bypass pump and the detector's primary pump.

		1 st case	2 nd case	3 rd case	4 th case	5 th case
Pumping	Roughing	Primary Pump detector only	Bypass Pump external only	Bypass Pump external + Primary Pump detector	Bypass Pump external + Primary Pump detector	Bypass Pump external + Primary Pump detector
	Passage set point in Gross Leak test mode (by default 20 mbar/hPa)					
	Test	Pumping Detector only	Pumping Detector only	Bypass Pump external + Pumping Detector ⁽¹⁾	Pumping detector only	Bypass Pump external + Pumping Detector ⁽¹⁾
Setting	Mode	No Bypass	Quick Pump	Partial Flow	Quick Pump	Partial Flow
	Evac. Delay	On/Off	On	on	Off	Off

(1) In this case, correcting leak rate to be applied

7.4.10 Regeneration

This function is used to "clean" the detector by automatically carrying out a series of short tests and inlet vents between each test. It allows to decrease the background further to a pollution in tracer gas.



NOTICE

Before launching this function, make sure that the leak detector is in an environment free of tracer gas pollution.

- ➔ Check that the detector is on Stand-by and that inlet vent is 'automatic'.
- ➔ From the "Settings" screen, press **[Test] [Regeneration]**.
- ➔ Block the detector's inlet port with a blanked-off flange.
- ➔ Press **[Start]**: regeneration will stop automatically after 1 hour.
- ➔ To stop regeneration before the automatic stop time, press **[Stop]** in the menu or . Start a test ("Zero activation" function not activated) to check that the detector is no longer polluted.

At the end of the regeneration, the configuration of the inlet vent is identical to what it was before the regeneration.



This function is recommended when the detector's background is high or when the part.



To launch the function from the control panel, set a function key to [Regeneration] (see 7.7.2).

7.4.11 Massive mode

This mode allows the detector to carry out a test (⁴He only) on a very gross leak in case the detector does not switch to Gross Leak mode and remains in roughing.

From the "Settings" screen, press [Test] [Massive Mode].

Active	⇒ Activate massive mode.
Sensitivity	⇒ Select the sensitivity <ul style="list-style-type: none"> • High = test on large volume (initial setting, recommended). Low = test on volume < 1 l (if necessary).

Function activated and pressure < 100 hPa, pressure stabilized during at least 10 s, a message notifies the operator that the detector has switched automatically to massive mode: the detector can then perform a qualitative leak test (leak information > 50 mbar·l/s (5 Pa·m³/s) only. The maximum use time is 55 minutes.



The massive mode cannot be used if an external gauge is selected (see 7.8.8).

7.5 Spectro Menu

→ From the "Settings" screen, press [Spectro].

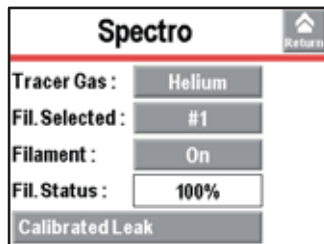

7.5.1 Tracer gas

The tracer gas is the gas searched for during a test. 3 gases are available: ⁴He, ³He and H₂.

From the "Settings" screen, press [Spectro].

Tracer gas	⇒ Select the tracer gas used.
------------	-------------------------------

The reject set point is memorized for each configurable tracer gas.

Calibration

The leak detector should be calibrated with a calibrated leak of the same type as the tracer gas used.

Hydrogen test

**DANGER****Explosion hazard.**

For detecting leaks with 'hydrogen' tracer gas, the operator must use hydrogenated nitrogen (mix of 95 % N₂ and 5 % H₂).

The detector's background is higher in H₂ than ⁴He/³He.

Typical H₂ background, during a test, when the detector is equipped with a blanking flange on the inlet port:

- at switching on:
 - low range $\pm 3 \cdot 10^{-6}$ mbar·l/s ($3 \cdot 10^{-7}$ Pa·m³/s)
- after 2 or 3 hours:
 - low range $\pm 5 \cdot 10^{-7}$ mbar·l/s ($5 \cdot 10^{-8}$ Pa·m³/s)



For quick access from the control panel, set a function key for [Tracer Gas] (see 7.7.2).

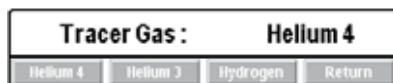

Fig. 24: "Tracer Gas" screen using a function key

7.5.2 Filament parameters

Fil. Selected	Indicates the filament used for the measurement (2 filaments in the analyzer cell).
Filament	Indicates if the filament used is 'on' or 'off' when the detector is switched on.
Fil. status	Indicator of analyzer cell performance. Initial settings: between 90 % and 100 % Normal operation: between 10 % and 100 % Normal wear on some cell components will reduce this value over time but will not reduce the accuracy of the detector's measurements.

7.5.3 Calibrated leak

For more information about calibrated leaks (see 6.7).

From the "Settings" screen, press [Spectro] [Calibrated leak].

Tracer gas	⇒ Set the tracer gas for the calibrated leak used for calibration.
Type	⇒ Define the type of calibrated leak used for calibration. <ul style="list-style-type: none"> • internal = calibration using the leak detector's internal calibrated leak (⁴He leak only). • external = calibration using an external calibrated leak (⁴He, ³He or H₂ leaks).
Unit	⇒ Set the calibrated leak unit used for calibration. ⁽¹⁾
Leak Value	⇒ Set the calibrated leak value used for calibration. ⁽¹⁾
Calibration valve	⇒ Define the actual status of the calibration valve. Used to open/close the manual calibration valve, for example. Remember to close the valve again after use. Manual calibration is only for experts.
Loss per Year (%)	⇒ Set the loss rate per year for the calibrated leak used for calibration. ⁽¹⁾
Ref. T. (°C)	⇒ Set the reference temperature for the calibrated leak used for calibration. ⁽¹⁾
Coeff. T. (%/°C)	⇒ Set the temperature coefficient for the calibrated leak used for calibration. ⁽¹⁾
Year	⇒ Set the month and year of calibration for the calibrated leak used for calibration. ⁽¹⁾
Internal T. (°C) or External T. (°C)	'Internal': indication of the temperature at the level of the detector internal calibrated leak 'External': setting of the internal temperature

⁽¹⁾ Use the information indicated on the calibrated leak used for calibration or on its calibration certificate.

In case of calibrated leak replacement, these parameters must be updated. When the parameters are saved, all the data from all the calibrated leaks set (1 internal leak (⁴He) and 3 external leaks (⁴He, ³He et H₂)) is memorised.

7.6 Maintenance Menu

→ From the "Settings" screen, press **[Maintenance]**.

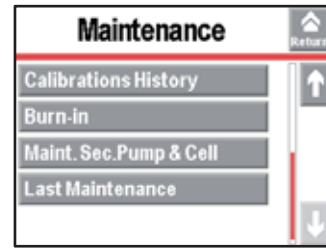
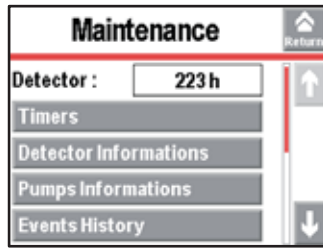

7.6.1 Detector

From the "Settings" screen, press [Maintenance].

Detector	Number of hours that the detector is used.
----------	--

7.6.2 Timers

From the "Settings" screen, press [Maintenance] [Timers].

Detector	Number of hours that the detector is switched on.
Filament 1	Number of hours that filament 1 is on. ⇒ Press [xxx h] [Counter reset] to reset the counter.
Filament 2	Number of hours that filament 2 is on. ⇒ Press [xxx h] [Counter reset] to reset the counter.
Calib. Leak	Indicates the month and year of calibration for the calibrated leak used for calibration.
Cycle Counter	Indicates the number of performed cycles since the last reset / the set cycle number. When the set value is reached, an information message is displayed.
Primary Pump	Indicates the number of primary pump operating since the last reset / the set hour number. When the set value is reached, an information message is displayed.
Sec. pump # 1	Indicates the number of secondary pump 1 operating since the last reset / the set hour number. When the set value is reached, an information message is displayed.
Sec. pump # 2 (ASM 392 only)	Indicates the number of secondary pump 2 operating since the last reset / the set hour number. When the set value is reached, an information message is displayed.



For quick access to the counters from the control panel, set a function key for [Maintenance] (see 7.7.2).

→ To set the set point and reset the cycle counter

From the "Settings" screen, press [Maintenance] [Timers] [xxxx Cy/xxxx Cy].

Cycles	Indicates as a % the number of cycles made in relation to the interval set.
Counter	Indicates the number of cycles made since the latest reset of the counter.
Interval	⇒ Set the value for the counter. When the set value is reached, an information message is displayed.
Reset Counter	⇒ Press [Counter reset] to reset the counter.

→ To set the set point and reset the operating hours counter for each pump's

From the "Settings" screen, press [Maintenance] [Timers] [xxxx h/xxxx h] for each pump

Pump XXX	Indicates as a % the number of operating hours for the pump XXX in relation to the interval set.
Counter	Indicates the number of operating hours for the pump since the latest reset of the counter.
Time interval	⇒ Set the value for the counter. When the set value is reached, an information message is displayed.
Reset Counter	⇒ Press [Counter reset] to reset the counter.

7.6.3 Detector Information

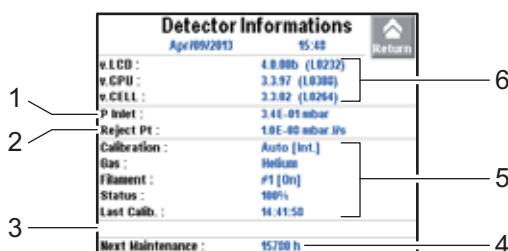

Fig. 25: Detector Information

1	Inlet pressure
2	Reject set point for the test method in progress
3	List of activated functions
4	Primary or secondary pump maintenance
5	Calibration information
6	Detector firmware information



For quick access from the control panel, set a function key for [Infor.] (see 7.7.2).

7.6.4 Pump Information

Primary Pump #1

From the "Settings" screen, press [Maintenance] [Pump Information] [Prim. Pump #1].

Used	Control of the pump by the detector
Status	Status of the pump
Speed	Setting of the pump use speed: Max/Min/Nominal
Synchro	Pump at the speed of use set

→ For more information about primary pump, press [ACP Information].



Secondary Pump #1 and #2

Secondary Pump #2: ASM 392 only

From the "Settings" screen, press [Maintenance] [Pump Information] [Sec. Pump #1] or [Sec. Pump #2].

Status	Control of the pump by the detector
Rotation	Pump status: Synchro/Down/Fail/Running/Ram up
Speed (rpm)	Pump running speed

→ For more information about secondary pump, press [TMP Information].

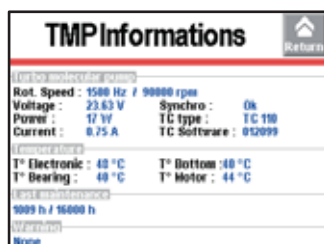

7.6.5 Event history

Event history records the last 30 events. Beyond 30, the oldest recorded event will be replaced by the most recent, and so on.

→ From the "Settings" screen, press **[Maintenance]** **[Event History]**.

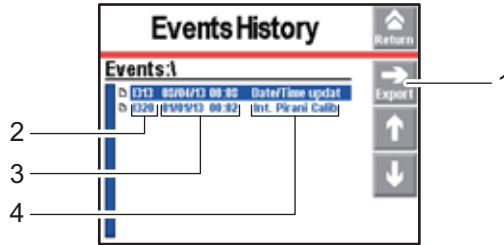

1	Exporting the history in .csv format to the SD card
2	RS code for the event
3	Date - Time of the event
4	Description of the event

Event = Error (Exxx) or Warning (Wxxx) or Event (Ixxx)

List of errors and warnings: see *chapter List of warnings/faults in Maintenance instructions*.

List of events:

Code	Event	Description
I300	Inlet vent	Inlet vent
I301	Stp on pollution	Test stops automatically if measured leak rate pollution > Pollution
I302	RVP ctr reset	Primary pump hour counter reset.
I303	TMP1 ctr reset	Secondary pump 1 hour counter reset
I304	TMP2 ctr reset	Secondary pump 2 hour counter reset (according to detector model)
I306	Fil 1 ctr reset	Filament 1 hour counter reset
I307	Fil 2 ctr reset	Filament 2 hour counter reset
I308	Cycle ctr reset	Cycle counter reset
I310	Autocal restart	Automatic start of a new autocalibration
I313	Date/Time update	Date or time modification
I318	Full param reset	Complete detector parameter reset
I319	Fil change	Filament change (manually or automatically from Maintenance menu)
I320	Int. Pirani Calib.	Automatic internal Pirani gauge calibration
I321	Storage delay	Detector switched off for 15 days (minimum)

7.6.6 Calibration history

The calibration history records the last 20 calibrations made. Beyond 20, the oldest recorded calibration will be replaced by the most recent and so on.

→ From the "Settings" screen, press **[Maintenance]** **[Calibration History]**.

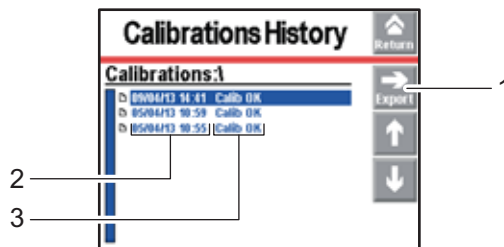

1	Exporting the history in .csv format to the SD card
2	Date - Time of the calibration
3	Calibration result

7.6.7 Burn-in

This function is used to prepare the detector, leaving it in optimal working condition by automatically carrying out a series of short tests and inlet vents between each test.



NOTICE

Before launching this function, make sure that the leak detector is in an environment free of tracer gas pollution.

- Check that the detector is on Stand-by and that inlet vent is 'automatic'.
- From the "Settings" screen, press **[Maintenance] [Burn-in]**.
- Block the detector's inlet port with a blanked-off flange.
- Press **[Start without calib.]** or **[Start with calib.]**: burn-in does not stop automatically.
 - **[Start without calib.]** = series of tests and inlet vents
 - **[Start with calib.]** = series of tests, inlet vents and calibrations (not available for sniffing test)
- To stop burn-in, press **[Stop]** on the menu or .

7.6.8 Maintenance for the analyzer cell and the secondary pump

To carry out maintenance on the secondary pump or the analyzer cell, the vacuum part of the detector must be at atmospheric pressure. This function is used to shut down the secondary pump and to perform an inlet vent so that the secondary pump and the analyzer cell are at atmospheric pressure.

- From the "Settings" screen, press **[Maintenance] [Maint.Sec. Pump & Cell]**.
- Press **[Stop & Vent]** to start the function.
 - The secondary pump slows to a speed that allows inlet vent.
 - A message notifies the operator when the leak detector can be shut down.
- Optional: to carry out an additional inlet vent before shutting down the detector, press **[Stop&Vent]**.
- If the operator does not want to shut down the detector, press **[Restart detector]**: the detector start-up screen is displayed.
- Shut down the detector, wait until the control panel turns off completely and unplug the electric power cable before working on the detector.

ASM 392: This procedure applies to the maintenance of the both secondary pumps.

7.6.9 Last maintenance

This function displays the last three maintenance operations performed on the detector and recorded by the technician having made the intervention.

- Use the scroll bar to display the last 3 recorded interventions.

From the "Settings" screen, press [Maintenance]. [Last maintenance].

Date	Date of the maintenance intervention
Nbr hours	Number of hours that the detector has been switched on at the time of the intervention.
Inspected by	Technician who performed the intervention.

7.7 Configuration Menu

- From the "Settings" screen, press **[Config.]**.

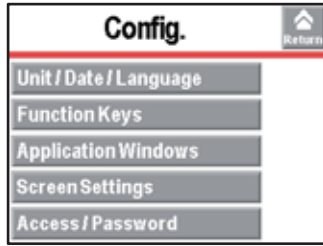

7.7.1 Time - Date - Unit - Language

The update of these parameters is automatically requested when the operator switches the detector on for the first time: after this, the operator can modify them at any time.

From the "Settings" screen, press [Config.] [Unit/Date/Language].	
Unit	⇒ Set the unit to be used. The set points/values set are not automatically converted to the new unit if the unit changes: they must be updated by the operator.
Date	⇒ Set the current date.
Time	⇒ Set the time. The time is not automatically updated when switching from summer time to winter time and vice versa: it must be updated by the operator.
Language	⇒ Set the language.

7.7.2 Function keys

The function keys are used to activate/stop a function or to adjust set points.

Per initial settings, 8 function keys are allocated and distributed over 2 levels: they can be reallocated by the operator.

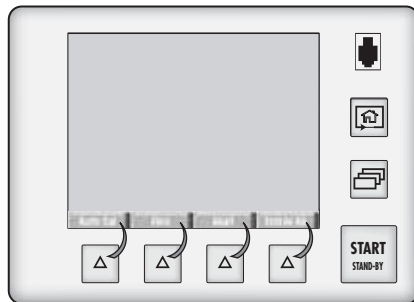

Fig. 26: Function keys

Allocating function keys

→ From the "Settings" screen, press [Config.] [Function Keys].



Thanks to the function keys, it is possible to give the operator access to a limited number of functions and to use a password to lock unauthorised functions on the "Settings" menu. They are sufficient to manage the detector.

- To allow the operator to use only the [Start/Stand-by] key, do not allocate a function to the function keys and lock the "Settings" menu.
- Up to 4 additional function keys can be added, for a maximum of 12. In this case, a 3rd level is made available to the operator.

Each function key can be allocated to a function chosen by the operator: see the example below.

Example: Allocate the 'Correction' function (1) to the [Mode] function key (2).

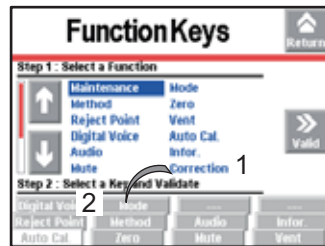

Fig. 27: Allocation objective

→ Select the 'Correction' function (1) using the and .

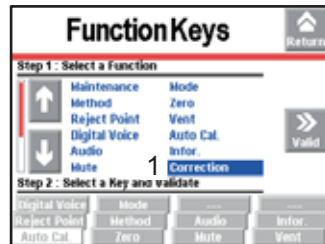

Fig. 28: Selecting the function

→ Select the **[Mode]** function key (2) by pressing repeatedly (key selected if background is white).

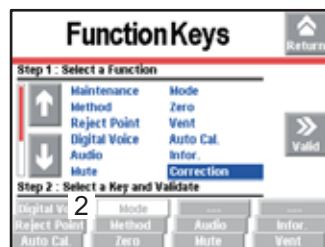

Fig. 29: Selecting the function key

→ Validate the settings (3): the function key (2) is now allocated to the **[Correction]** function.

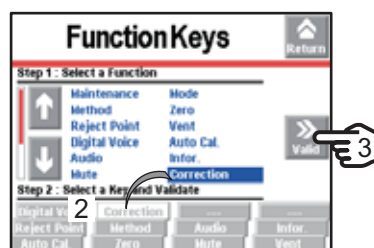



Fig. 30: Result of the allocation

7.7.3 Application screens

→ From the "Settings" screen, press **[Config.] [Application Windows]**.

By pressing repeatedly on the key , the various screens available appear (see 6.1.3).

The operator can hide one or more screen or switch the order in which they appear. The "Standard" application screen is always available in 1st position.

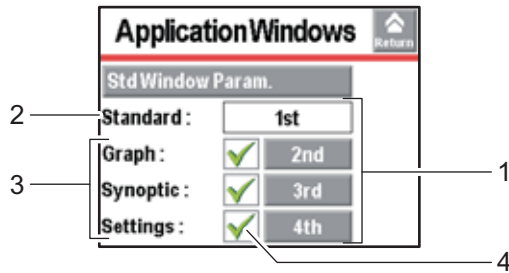

1	Order of the displayed screens with the key	
2	"Standard" application screen always displayed	
3	Available screens	
4	Displaying/hiding the application screen	

The screen order can be modified: press the order number (example: [3rd]) and use the **+** and **-** keys to choose the new order number then confirm.



Fig. 31: The "Synoptic" screen order has switched from 3 to 4

When a screen is no longer selected or if its order has been changed, the general order is automatically updated.

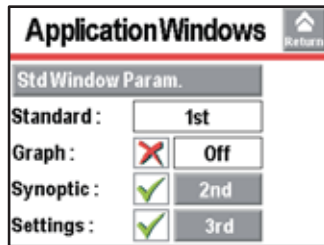

Fig. 32: The "Graph" screen is no longer available

When a screen is selected again, it automatically moves to last place.

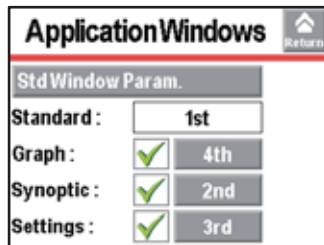

Fig. 33: The "Graph" screen is available again, and in last place.

Setting the "Standard" screen

From the "Settings" screen, press [Config.] [Application Windows] [Std Window Parameters].

Std-By Value	⇒ Display/Hide the leak rate display in Stand-by mode.
Inlet Pressure	⇒ Display/Hide the inlet pressure display.
Extra Pressure	⇒ Display/Hide the pressure display of for the cell or an external gauge. The external gauge (at the customer's expense) is a gauge installed on the customer's application, connected to the 37 pin I/O board.

From the "Settings" screen, press [Config.] [Application Windows] [Std Window Parameters].

Lower Display Limit	⇒ Set the minimum value displayed for leak rate. Leak rate not displayed if the value is less than the 'Lower Display Limit' configured value.
Affichage 2nd digit	⇒ Display/Hide the display of a second digit after the comma for the leak rate digital display.

From the "Settings" screen, press [Config.] [Application Windows] [Std. Window Parameters] [Leak Rate Bargraph].

Zoom on set point	⇒ Activate zoom to set point. Zoom to set point is used to display on the bargraph the reject set point centred on 2 decades.
Low Decade	⇒ Set the low decade for the bargraph display.
High Decade	⇒ Set the high decade for the bargraph display.

7.7.4 Screen Settings

From the "Settings" screen, press [Config.] [Screen Settings].

Brightness	⇒ Set the brightness.
Contrast	⇒ Set the contrast.
Panel off	⇒ Activate the sleep mode screen. The screen is in sleep mode when the back light goes off (black screen). The device appears to be off, but this is not the case! Simply touching the screen reactivates the display.
Paging Func.	⇒ Activate the Paging function. When a RC 500 WL remote control (accessory) is used, the 'Paging' function makes it possible to easily find the remote if it is located within its field of use with the detector. When the function is activated, the remote emits a sound signal so it can be located. To stop the sound signal, deactivate the Paging function.



→ Press [Reset Panel Param.] to reset the control panel parameters.

7.7.5 Access - Password

→ From the "Settings" screen, press [Config.] [Access/Password].

→ Enter the password ('5555' by default) and validate.

Menu access The operator can lock access to one or more menus on the "Settings" screen. To access a locked menu, the operator will be asked to provide the password.

- Lock a menu by pressing .
- Unlock a menu by pressing .

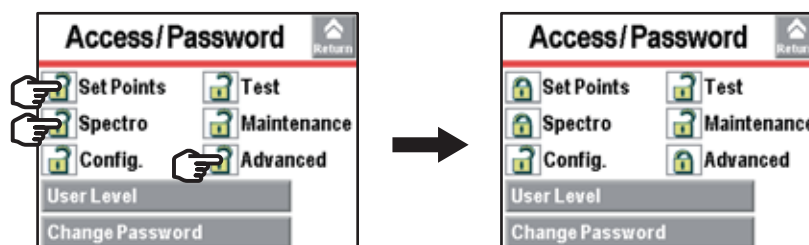



Fig. 34: Example: Locking the Set Points, Spectro and Advanced menus
On the "Settings" screen, the locked menus are indicated by .

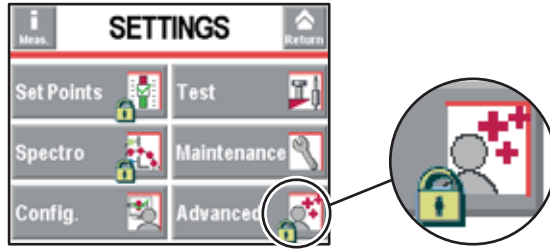

Fig. 35: Locked menus

- Change password**
- From the "Settings" screen, press **[Config.] [Access/Password]**.
 - Enter the password ('5555' by default) and validate.
 - Press **[Change Password]**.
 - Enter the new password and validate.



The password is saved in the control panel. If the password is forgotten, it can be found using the RS-232: see the RS-232 operating instructions.

- User level**
- From the "Settings" screen, press **[Config.] [Access/Password] [User level]**.
- 3 user levels can be used to restrict the display and operator access to settings and functions:
- restricted access,
 - medium access,
 - full access.

Limits with Restricted access





- Key  invalid: no settings can be made without password.
- Pictogram  invalid.
- Function keys hidden.
- Inlet pressure and cell pressure hidden.
- Key  invalid: launch of a test via a communication interface only.
- Measured leak rate and reject set point displayed only in test.



Fig. 36: Displays with Restricted access



With Medium or Restricted access, the operator can temporarily access the 6 menus on the "Settings" screen to set parameters.

- Press and hold the key  until the "Settings" screen is displayed with all the locked menus.
- Press the desired menu.
- Enter the current password ('5555' by default) and validate.
- Carry out the desired parameter settings.

Limits with Medium access

- Key  invalid: no settings can be made without password.
- 2 function keys available: **[Basic Param.]** and **[Info.]**.

Basic Param	
Hard Vac. Set Points :	1.00E-07 mbar.l/s
Sniffler Set Points :	1.00E-06 mbar.l/s
Method :	Hard Vacuum
Mode :	Normal
Gas :	Helium 4
P Inlet :	2.2E-03 mbar

Detector Information	
v.ECD :	4.800d (L0343)
v.CPU :	3.3.99 (L0399)
v.CELL :	2.2.02 (L0264)
P Inlet :	2.5E-03 mbar
Reject Pt :	1.0E-07 mbar.l/s
Calibration :	Auto [Int.]
Gas :	Helium 4
Filament :	#1 [On]
Status :	100%
Last Calib. :	10:53:17
Next Maintenance :	10000 h

- Function keys hidden.
- Inlet pressure and cell pressure hidden.
- Key  valid.
- Measured leak rate and reject set point displayed only in test.

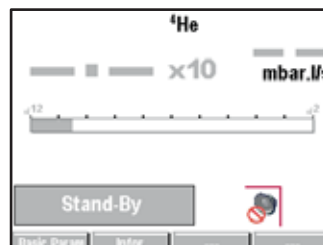



Fig. 37: Displays with Medium access



With Medium or Restricted access, the operator can temporarily access the 6 menus on the "Settings" screen to set parameters.

- Press and hold the key  until the "Settings" screen is displayed with all the locked menus.
- Press the desired menu.
- Enter the current password ('5555' by default) and validate.
- Carry out the desired parameter settings.

Limits with Full access

- No limit.

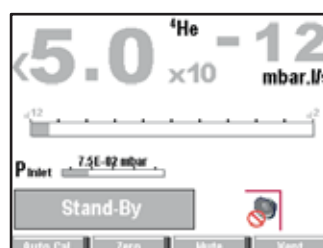



Fig. 38: Displays with Full access

Operator with Restricted or Medium access changing the access level.

- Press  until the "Settings" screen is displayed with all the locked menus.
- Press **[Config.]**.
- Enter the current password ('5555' by default) and validate.
- Press **[Access/Password]**.

- Enter the current password ('5555' by default) and validate.
- Press **[User Level]**.
- Change the access level: see below the limits for each level.

Operator with Full access changing the access level.

- From the "Settings" screen, press **[Config.] [Access/Password]**.
- Enter the current password ('5555' by default) and validate.
- Press **[User Level]**.
- Change the access level: see below the limits for each level.

7.8 Advanced Menu

The Advanced menu is reserved for leak detection experts and/or for setting a particular product.

- From the "Settings" screen, press **[Advanced]**.

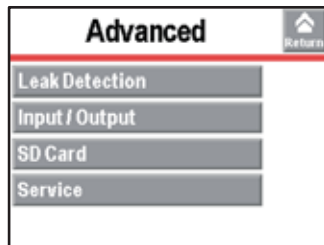

7.8.1 Leak Detection Menu

- From the "Settings" screen, press **[Advanced] [Leak Detection]**.

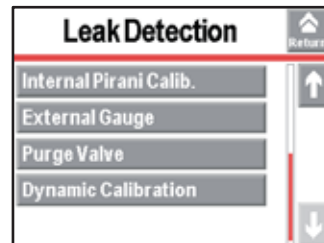
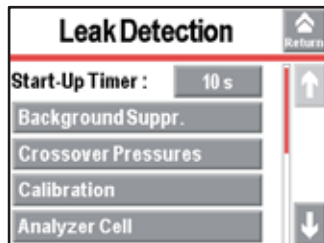

7.8.2 Leak Detection: Start-up timer

The start-up timer prevents the leak detector from being used for a pre-determined duration after it has been switched on. This means measurements cannot be made until the leak detector is thermically stabilized, or while traces of tracer gas remain in the detector.

From the "Settings" screen, press [Advanced] [Leak Detection].

Start-up timer	⇒ Set the start-up timer.
----------------	---------------------------

7.8.3 Leak detection: Background suppression

This function is used to suppress the intrinsic detector's background.

After calibration, if the function is activated, the leak detector's background will be lower than $1 \cdot 10^{-12}$ mbar-l/s ($1 \cdot 10^{-13}$ Pa·m³/s).

From the "Settings" screen, press [Advanced] [Leak Detection] [Background Supp.].

Activation	⇒ Activate the function ('on' if activated).
------------	--



It is advised to keep this function activated ('On').

7.8.4 Leak Detection: Crossover Pressures

In a hard vacuum test, used to define the crossover pressures in the different test modes.

From the "Settings" screen, press [Advanced] [Leak Detection] [Crossover pressures].

Gross Leak	⇒ Set the cross over from Roughing to Gross Leak mode.
Normal	⇒ Set the cross over from Gross Leak mode to Normal mode.
High Sensitivity	⇒ Set the cross over from Normal to High Sensitivity mode.

7.8.5 Leak Detection: Calibration



NOTICE

Detector calibration

20 minutes after the switched on, the detector suggests that the operator carry out an auto-calibration (if calibration parameter = 'operator'). For the correct use of the detector, **this auto-calibration must be performed**. In all situations, a calibration must be performed:

- at least once a day
- to optimise the measurement reliability for high sensitivity tests
- if it is uncertain whether the detector is working properly
- during intense and continuous operation: start an internal calibration at the beginning of each work session (e.g. work in teams, every 8 hours).

Calibration makes it possible to verify that the detector is properly adjusted to detect the selected tracer gas and display the correct leak rate value.

From the "Settings" screen, press [Advanced] [Leak Detection] [Calibration].

Calibration	⇒ Select the type of calibration. See details below.
Calib.Checking	⇒ Activate the calibration checking and set the frequency. See details below.

The leak detector can also be calibrated using an external leak (see 6.7). By default, the internal calibrated leak is selected to perform a quick calibration of the leak detector.

'Calibration' detail

- **Calibration = 'operator'**

Calibration started by the operator.

→ Press the [AUTOCAL].

If calibration does not start within 20 minutes after the leak detector is switched on, message is displayed.

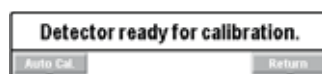

Fig. 39: Leak detector ready for calibration

- **Calibration = 'manual'**

Calibration starts manually.

Operation reserved for service centres and experts only.

- **Calibration = 'start-up checking'**

A "control calibration" is automatically launch during the power-up procedure of the detector: see below

Calibration starts automatically when the leak detector is switched on.

'Calibration control' detail

Calibration control saves the operator time because this operation is quicker than the full calibration.

The calibration control is deactivated if calibration = 'manual'.

The calibration control is performed with the leak detector's internal calibrated leak (leak type parameter = 'internal').

The leak detector compares the measured leak rate of the internal calibrated leak with the set leak rate of the internal calibrated leak:

- If the ratio is within the limits allowed, the leak detector is properly calibrated.
- If the ratio is outside those limits, a message appears suggesting that a full calibration of the leak detector be started.

Checking	⇒ Select the type of calibration (activated if 'automatic' has been set).
Frequency	⇒ Set the set points (cycles and times) for triggering the calibration control. The first set point reached will trigger the control.



To launch the function from the control panel, set a function key to [Check Cal].



At any time, the operator can start a leak detector calibration control: detector in Stand-by mode, press the [AUTO CAL] function key twice within 5 seconds.

7.8.6 Leak detection: Analyzer cell

From the "Settings" screen, press [Advanced] [Leak Detection] [Analyzer Cell].

Fil. Selected	Indicates the filament used for the measurement (2 filaments in the analyzer cell).
Filament	Indicates if the filament used is 'on' or 'off' when the detector is switched on.
<ul style="list-style-type: none"> - Triode pressure - Elec.Zero - Target value - Acc. voltage (V) - Emission (mA) - Coeff. Sens. 	Parameters for manual calibration. This type of calibration is reserved for service centres and leak detection experts only.
Calib. valve	⇒ Define the actual status of the calibration valve. Used to open/close manually the calibration valve, for example. Remember to close the valve again after use. Manual calibration is only for experts.
Internal T (°C)	Indicates the temperature at the detector's internal calibrated leak.



Do not switch off the filament except for carrying out manual calibration. It is not necessary to switch the filament off in Stand-by mode to save it.

- The leak detector switches automatically from one filament to the other if the selected filament currently being used becomes defective.
- When switched on, the leak detector uses the filament that was selected when it was shut down.

7.8.7 Leak Detection: Internal Pirani gauge calibration

This function is used to calibrate the detector's internal gauge.

- Procedure**
- From the "Settings" screen, press **[Advanced] [Leak Detection] [Internal Pirani Calib.]**.
 - Block the detector's inlet with a blanked-off flange.
 - Make sure:
 - that the leak detector is in a hard vacuum test, in the most sensitive test mode.
 - that the end of the cycle is manual (= 'operator').

The calibration takes place in 2 stages: setting the limit pressure and setting the atmospheric pressure.

- Setting the limit pressure**
- Start a test: press  .
 - The "Pressure" value decreases: wait for this value to stabilise (around 5 minutes).
 - Make sure that the internal pressure is significantly lower than $1 \cdot 10^{-3}$ hPa.
 - Press the **[>HV]**.

Setting the atmospheric pressure

- Stop the test: press the .
- Create an inlet vent: press **[Inlet vent]**.
- Make sure that the detector is at atmospheric pressure.
- The "Pressure" value increases: wait for this value to stabilise (around 5 minutes) and press the **[>Atm]**.

7.8.8 Leak Detection: External gauge

Allows the leak detector to be managed by an external gauge.

Prerequisites

- Detector equipped with the 37 pin I/O board (option or accessory (see 10)).
- Deactivate the Massive mode to use an external gauge Massive Mode (see 7.4.11).
- Configure the pressure source of the pump inlet (= 'external').

Possible gauges

		Type of gauge detected by the detector	Gauge model
Linear gauges	Capacitives	Linear	CMRxxx
	Piezo	Linear	APRxxx
Logarithmic gauges	Pirani	TPR/PCR	TPRxxx
	Capacitives Pirani	TPR/PCR	PCRxxx

- 3 cables (3 m, 10 m and 20 m) available for purchase (see 10).
- The gauge and the cable are the client's responsibility

Settings

From the "Settings" screen, press [Advanced] [Leak Detection] [External Gauge] .	
Gauge	⇒ Select the external gauge model.
Ext. Pressure (mbar)	Indicates the pressure measured by the external gauge.
Inlet Press. source	⇒ Set the inlet pressure displayed on the "Standard" screen (see 7.7.3): 'internal' (leak detector's internal gauge) or 'external' (external gauge on the customer's installation)
Full scale (mbar)	Only for a linear gauge ⇒ Set the operating range for the gauge: value indicated on the gauge.

7.8.9 Leak Detection: Purge valve

The purge valve prevents the detector from becoming polluted thanks to a continuous air flow inside the vacuum part of the detector.

It is automatically managed by the leak detector.

Detector in stand-by, when the purge valve is open, 'Purge' displays on the standard screen (see 6.1.4).

Never change this parameter: modification only done by service center experts.

From the "Settings" screen, press [Advanced] [Leak Detection] [Purge Valve] .	
Purge Valve	⇒ Set the status of the valve: <ul style="list-style-type: none"> • Automatic = valve opening/closing defined in the detector's supervisory firmware (optimized management of the purge) • Closed/Open = permanent status of the valve

7.8.10 Input/Output menu

- From the "Settings" screen, press **[Advanced]** **[Input/Output]**.

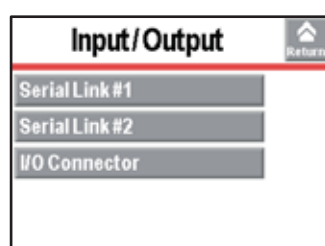

7.8.11 Input/Output: Serial Link 1 and Serial Link 2

From the "Settings" screen, press [Advanced] [Input/Output], then [Serial Link 1] or [Serial Link 2].

Type	⇒ Set the type of serial link: see the operating instructions of the accessory/option to use (see 1.1.1).
Parameters	⇒ Set the serial link mode: see the operating instructions of the accessory/option to use (see 1.1.1).

7.8.12 Input/Output: I/O connector

→ From the "Settings" screen, press [Advanced] [Input/Output] [I/O Connector].

The detector is equipped, according to option:

- either with a 15 pin I/O interface (see **15 pin I/O board Operating instructions**).
- or with a 37 pin I/O interface (see **37 pin I/O board Operating instructions**).

7.8.13 SD Card menu

From the "Settings" screen, press [Advanced] [SD card].

Load Detector Param.	⇒ Load the saved parameters onto the SD card.
Save Detector Param.	⇒ Save the leak detector parameters to the SD card.
View * BMP	⇒ View the saved ".bmp" files.



Creating a library of the configurations for each application is recommended if the detector is used for more than one application. Any SD card on the market can be used except cards with High Capacity technology, regardless of the memory size. Before use, make sure that the SD card is not locked (message "SD card not detected" displayed).

7.8.14 Service

Access to the Service menu is password protected. Reserved for the Service Centres.

8 Maintenance / replacement



NOTICE

Disclaimer of liability

Pfeiffer Vacuum accepts no liability for personal injury or material damage, losses or operating malfunctions due to improperly performed maintenance. The liability and warranty entitlement expires.

8.1 Maintenance intervals and responsibilities

The detector maintenance operations are described in the ***Maintenance instructions*** for the detector.

The manual specifies:

- maintenance intervals
- maintenance instructions
- shutting the product down
- tools and spare parts.

The maintenance instructions is available on www.pfeiffer-vacuum.com and on the ***CDRom of the detector's operating instructions***.

9 Service

Pfeiffer Vacuum offers first-class customer service!

- On-Site maintenance for many products
- Overhaul/repair at the nearby Service Location
- Fast replacement with refurbished exchange products in mint condition
- Advice on the most cost-efficient and quickest solution

Detailed information, addresses and forms at: www.pfeiffer-vacuum.com (Service).

Overhaul and repair at the Pfeiffer Vacuum Service Center

The following general recommendations will ensure a fast, smooth servicing process:

- Fill out the "Service Request/Product Return" form and send it to your local Pfeiffer Vacuum Service contact.
- Include the confirmation on the service request from Pfeiffer Vacuum with your shipment.
- Fill out the declaration of contamination and include it in the shipment (mandatory!). The Declaration of contamination is valid for any product/device including a part exposed to vacuum.
- Dismantle all accessories and keep them.
- Close all the flange opening ports by using the original protective covers or metallic airtight blank flanges for contaminated devices.
- If possible, send the pump or unit in its original packaging.

Sending contaminated pumps or devices

No devices will be accepted if they are contaminated with micro-biological, explosive, or radioactive substances. "Hazardous substances" are substances and compounds in accordance with the hazardous goods regulations (current version).

- Neutralize the pump by flushing it with nitrogen or dry air.
- Close all openings airtight.
- Seal the pump or device in suitable protective film.
- Return the pump/device only in a suitable and sturdy transport container and send it in while following applicable transport conditions.

Pump or device returned without declaration of contamination form fully completed and/or not secured in suitable packaging will be decontaminated and/or returned at the shipper's expense.

Exchange or repair

The factory operating parameters are always pre-set with exchange or repaired devices. If you use specific parameters for your application, you have to set these again.

Service orders

All service orders are carried out exclusively according to our general terms and conditions for the repair and maintenance, available on our website.

10 Accessories

Description	Order number
Standard remote control (mbar·l/s)	106688
Standard remote control (Torr·l/s)	108881
Standard remote control (Pa·m ³ /s)	108880
Standard remote control (Pa·m ³ /s + Japon)	106690
RC 10 remote control (wireless)	124193
Standard Sniffer Probe	See Pfeiffer Vacuum catalog
Sniffer probe extension (10 m)	090216
Smart Sniffer Probe (3 m)	BG 449 207 -T
Smart Sniffer Probe (5 m)	BG 449 208 -T
Smart Sniffer Probe (10 m)	BG 449 209 -T
⁴ He calibrated leak	See Pfeiffer Vacuum catalog
Adaptor for external calibrated leak DN 25 ISO-KF	110716
Spray gun (Elite)	109951
Spray gun (Standard)	112535
37 pin I/O board - Standard	126254
37 pin I/O board - Ethernet	126255
External Communication Box ECB Wi-Fi	125902
Inlet filters: available in bronze or stainless steel, meshing from 5 to 20 µm	Consult us
Bypass kit (37 pin I/O board requested)	PT 445 411 -T (Europe) + PT 445 413 -T (US)
Bottle holder	126561
Locking clamp DN 40 ISO-KF	118801
External gauge type CMRxxx / APRxxx / TPRxxx / PCRxxx (37 pin I/O board requested)	See Pfeiffer Vacuum catalog
Cables for detector/external gauge connection (CMRxxx / APRxxx / TPRxxx / PCRxxx)	
3 m	A333746
10 m	A333747
20 m	A333748

11 Technical data and dimensions

11.1 General

Databases of the leak detectors' technical characteristics Pfeiffer Vacuum:

- Technical characteristics according to:
 - AVS 2.3: Procedure for calibrating gas analyzers of the mass spectrometer type.
 - EN 1518: Non-destructive testing. Leak testing. Characterization of mass spectrometer leak detectors.
 - ISO 3530: Methods of calibrating leak-detectors of the mass-spectrometer-type used in the field of vacuum technology.
- Zero function or background suppression activated, in standard conditions (20 °C, 5 ppm ⁴He ambient, degassed detector).
- Acoustic pressure level: distance in relation to the detector 1 m.

11.2 Technical data

Parameter	ASM 390	ASM 392
Dimension (L x W x H)	1072 x 455 x 1025 mm	1072 x 455 x 1025 mm
Flange (in)	DN 40 ISO-KF	DN 40 ISO-KF
Pumping speed for He	10 l/s	25 l/s
Backing pump capacity	35 m ³ /h	35 m ³ /h
Start-up time (20°C) without calibration	2 min	2 min
Noise level	54 dB (A)	55 dB (A)
Power consumption (230 V)	800 W	800 W
Maximum power consumption (230 V)	1600 W	1600 W
Operating temperature	10 - 35 °C	10 - 35 °C
Maximum inlet test pressure	20 hPa	20 hPa
Weight	125 kg ⁽¹⁾	130 kg ⁽¹⁾
Detectable gases	⁴ He, ³ He, H ₂	⁴ He, ³ He, H ₂
Test method	Vacuum & sniffing leak detection	Vacuum & sniffing leak detection
Minimum detectable leak rate for ⁴ He (sniffing leak detection)	1 · 10 ⁻⁸ mbar · l/s (1 · 10 ⁻⁹ Pa · m ³ /s)	1 · 10 ⁻⁸ mbar · l/s (1 · 10 ⁻⁹ Pa · m ³ /s)
Minimum detectable leak rate for ⁴ He (vacuum leak detection)	1 · 10 ⁻¹² mbar · l/s (1 · 10 ⁻¹³ Pa · m ³ /s)	1 · 10 ⁻¹² mbar · l/s (1 · 10 ⁻¹³ Pa · m ³ /s)
Supply	100-240 V, 50/60 Hz	100-240 V, 50/60 Hz

⁽¹⁾ Maxi weight (detector + accessories + parts to be tested + ...) = 200 kg

Environmental conditions

Storage temperature	- 25 °C à + 70 °C
Maximum humidity of air	95 % without condensing
Maximum magnetic field	3 mT

11.3 Units of measurement

Conversion table: pressure units

	mbar	bar	Pa	hPa	kPa	Torr mm Hg
mbar	1	1 · 10 ⁻³	100	1	0.1	0.75
bar	1000	1	1 · 10 ⁵	1000	100	750
Pa	0.01	1 · 10 ⁻⁵	1	0.01	1 · 10 ⁻³	7.5 · 10 ⁻³
hPa	1	1 · 10 ⁻³	100	1	0.1	0.75
kPa	10	0.01	1000	10	1	7.5
Torr mm Hg	1.33	1.33 · 10 ⁻³	133.32	1.33	0.133	1

$$1 \text{ Pa} = 1 \text{ N/m}^2$$

Conversion table: gas throughput units

	mbar·l/s	Pa·m ³ /s	sccm	Torr·l/s	atm·cm ³ /s
mbar·l/s	1	0.1	59.2	0.75	0.987
Pa·m ³ /s	10	1	592	7.5	9.87
sccm	$1.69 \cdot 10^{-2}$	$1.69 \cdot 10^{-3}$	1	$1.27 \cdot 10^{-2}$	$1.67 \cdot 10^{-2}$
Torr·l/s	1.33	0.133	78.9	1	1.32
atm·cm ³ /s	1.01	0.101	59.8	0.76	1

11.4 Dimensions

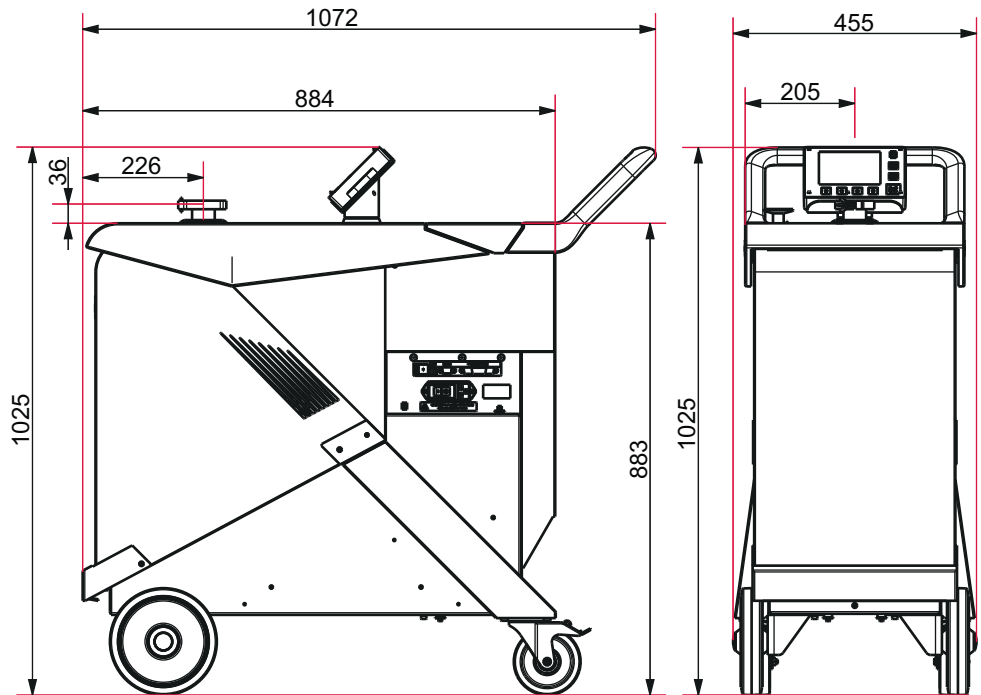

12 Appendix

12.1 Tree diagram of the "Settings" menus

The following table shows the detector's initial settings. When the detector is off, values and parameters are saved for the next use.

The operator can save and download different leak detector configurations (see 7.8.13).

Set point setting

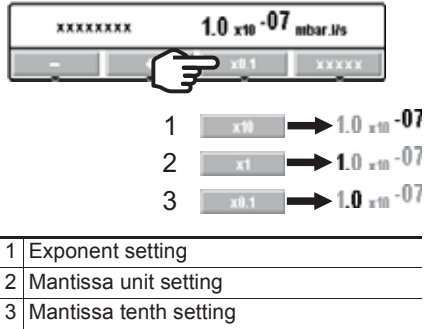

SET POINTS			
Selection		Choice - Setting limit	Initial settings
Audio	Status	Invalid / Valid	Valid
	Setting (If valid)	1 - 9	2
Digital voice	Status	Invalid / Valid	Valid
	Setting (If valid)	1 - 9	4
Pollution	Status	Invalid / Valid	Invalid
	Setting (If valid)	1·10 ⁺¹⁹ - 1·10 ⁻¹⁹	1·10 ⁻⁰⁵
Hard Vacuum Set Points	Reject point	1·10 ⁺⁰⁶ - 1·10 ⁻¹³	1·10 ⁻⁰⁸
Sniffer set Points	Reject point	1·10 ⁺⁰⁶ - 1·10 ⁻¹²	1·10 ⁻⁰⁴
	Probe clogged	1·10 ⁺¹⁹ - 1·10 ⁻¹⁹	1·10 ⁻⁰⁶
Other Set pts	Reject Point 2 (If I/O 37 pins)	1·10 ⁺¹⁹ - 1·10 ⁻¹⁹	2·10 ⁻⁰⁷
	Reject Point 3 (If I/O 37 pins)	1·10 ⁺¹⁹ - 1·10 ⁻¹⁹	3·10 ⁻⁰⁷
	Reject Point 4 (If I/O 37 pins)	1·10 ⁺¹⁹ - 1·10 ⁻¹⁹	4·10 ⁻⁰⁷
	Reject Point 5 (If I/O 37 pins)	1·10 ⁺¹⁹ - 1·10 ⁻¹⁹	5·10 ⁻⁰⁷
Other Pressure Set pts	Pressure reject Point 1	5·10 ⁻⁵ - 3·10 ⁺²	2·10 ⁺¹
	Pressure reject Point 2	5·10 ⁻⁵ - 3·10 ⁺²	1·10 ⁺⁰

TEST			
Selection		Choice - Setting limit	Initial settings
Method		Hard Vacuum / Sniffer	Hard Vacuum
HV Correction	Status	Invalid / Valid	Invalid
	Setting (If valid)	1·10 ⁺²⁰ - 1·10 ⁻²⁰	1·10 ⁻³
Mode	(If hard vacuum test method)	Gross leak / Normal / High sensitivity	High sensitivity
ProbeType	(If sniffer test method)	Standard / Smart	Standard
Cycle End	Automatic cycle end		Operator / Automatic
	Setting (If automatic)	Roughing Timer	Status Setting
		Test Timer	Status Setting

TEST			
Selection		Choice - Setting limit	Initial settings
Inlet Vent	Inlet Vent		Operator / Automatic
	Delay		0 - 2 s
	Vent Timer	Status	Invalid / Valid
		Setting (If automatic)	0 - 1 h
Memo Function	Active		No / Yes
	Display Time	Status	Invalid / Valid
		Setting (If automatic)	0 - 1 h
Zero activation	Activation		None / Operator / Automatic
	Zero Exit (if operator)		Press once / Press > 3 s
	Value (If automatic)	Trigger	Timer / Set point
		Setting	If Timer
		If Set Point	
Bypass Option	Mode		None / Quick Pump. / Partial Flow
	Evacuation delay		Off / On
Regeneration	Function launching		-
Massive Mode	Active		No / Yes
	Sensitivity		High / Low

SPECTRO			
Selection		Choice - setting limit	Initial settings
Tracer Gas		Helium 4 / Helium 3 / Hydrogen	Helium 4
Filament selected		1 / 2	1
Filament		Off / On	On
Filament Status		0 - 100 %	100 %
Calibrated Leak	Tracer Gas		Helium 4 / Helium 3 / Hydrogen
	Type		Internal / External
	Unit		mbar·l/s / Pa·m ³ /s / Torr·l/s / atm.cc/s / ppm
	Leak Value		-
	Loss Per Year (%)		0 - 99
	Reference Temperature (°C)		0 - 99
	Temperature Coefficient (%/°C)		0.0 - 9.9
	Year		-
Internal Temperature (°C) (If type = internal)		-	
External Temperature (°C) (If type = external)		-	

MAINTENANCE					
Selection			Choice - Setting limit	Initial settings	
Detector			-	20	
Timers	Detector		-	20	
	Filament 1	Counter	-	20	
		Reset counter	Function launching	-	-
	Filament 2	Counter	-	0	
		Reset counter	Function launching	-	-
	Calibrated leak		-	To set	
	Cycle Counter	Counter	-	0	
		Time interval	$1 \cdot 10^{+19} - 1$	$5 \cdot 10^5$	
		Reset counter	Function launching	-	-
	Primary Pump	Timer (h)	-	20	
		Time interval (h)	0 - 99999	17200	
		Reset counter	Function launching	-	-
	Secondary Pump 1	Timer (h)	-	20	
		Time interval (h)	-	17200	
		Reset counter	Function launching	-	-
		Speed (rpm)	-	-	
	Secondary Pump 2 (ASM 392 only)	Timer (h)	Timer (h)	20	
		Time interval (h)	Time interval (h)	17200	
Reset counter		Reset counter	-	-	
Speed (rpm)		Speed (rpm)	-	-	
Detector Information	Access to general information		-	-	
Pump Information	Primary Pump 1	Used	-	Yes	
		Status	-	On	
		Speed	-	Mini	
		Synchro	-	Yes	
		ACP information	Access to general information	-	-
	Secondary Pump 1	Status	-	On	
		Rotation	-	Synchro	
		Speed (rpm)	-	90000	
		TMP information	Access to general information	-	-
	Secondary Pump 2 (ASM 392 only)	Status	-	On	
		Rotation	-	Synchro	
		Speed (rpm)	-	90000	
		TMP information	Access to general information	-	-
Events History			-	Empty	
Calibration History			-	Empty	
Burn-in	Function launching		-	-	
Maintenance Secondary Pump and Cell	Function launching		-	-	
Last maintenance	Maintenance work 1	Date	-	-	
		Nbr hours	-	-	
		Inspected by	-	-	
	Maintenance work 2	Date	-	-	
		Nbr hours	-	-	
		Inspected by	-	-	
	Maintenance work 3	Date	-	-	
		Nbr hours	-	-	
		Inspected by	-	-	

CONFIGURATION						
Selection			Choice - Setting limit	Initial settings		
Unit/Date/Time/Language	Unit		mbar·l/s / Pa·m ³ /s / Torr·l/s / atm·cc/s / ppm / sccm / sccs mtorr·l/s	To set		
	Date		mm/dd/yyyy	To set		
	Time		hh:mm:ss	To set		
	Language		English / French / German / Italian / Chinese / Japanese / Korean / Spanish / Russian	To set		
Function keys	Setting		-	-		
Application Windows	Standard Window Parameters	Bargraph leak rate	Zoom on Set Point	No / Yes	No	
			Low Decade	$1 \cdot 10^{+5} - 1 \cdot 10^{-13}$	$1 \cdot 10^{-12}$	
			High Decade	$1 \cdot 10^{+0} - 1 \cdot 10^{-12}$	$1 \cdot 10^{-2}$	
		Stand-By Value		Hide / Show	Show	
		Inlet Pressure		Hide / Show	Show	
		Extra Pressure		Hide / Show	Hide	
		Lower Display Limit		$1 \cdot 10^{+19} - 1 \cdot 10^{-19}$	$1 \cdot 10^{-13}$	
	2nd digit display		Hide / Show	Show		
	Standard	Access		-	Show	
		Order		-	1 ^{er}	
	Graph	Access		Hide / Show	Show	
		Order (If Show)		2 nd - 4 th	2 nd	
	Synoptique	Access		Hide / Show	Show	
		Order (If Show)		2 nd - 4 th	3 rd	
Settings	Access		Hide / Show	Show		
	Order (If Show)		2 nd - 4 th	4 th		
Screen settings	Brightness		High / Low	High		
	Contrast		0 - 100	50		
	Panel Off		None / 15 min / 30 min / 1 h / 2 h / 4 h	None		
	Paging Function	Without wireless remote control detected		-	None	
		With wireless remote control detected		Off / On	Off	
	Reset panel parameters	Function launching		-	-	

CONFIGURATION			
Selection		Choice - Setting limit	Initial settings
Access / Password	Password		0000 - 9999
	Set Points Menu Access		Lock / Unlock
	Test Menu Access		Lock / Unlock
	Spectro Menu Access		Lock / Unlock
	Maintenance Menu Access		Lock / Unlock
	Configuration Menu Access		Lock / Unlock
	Advanced Menu Access		Lock / Unlock
	User Level		Restricted / Medium Access / Full Access
	Change Password		0000 - 9999

ADVANCED				
Selection		Choice - Setting limit	Initial settings	
Leak Detection	Start Up Timer		0 - 1 h	
	Background Suppression	Activation	Off / On	
	Crossover Pressures (mbar)	Gross Leak		$2 \cdot 10^{+1}$ - $5 \cdot 10^{-1}$
		Normal		$5 \cdot 10^{-1}$ - $2 \cdot 10^{-1}$
		High sensitivity		$5 \cdot 10^{-2}$ - $3 \cdot 10^{-2}$
	Calibration	Calibration		Operator / Check at start / Manual
		Calibration checking	Checking	Operator / Automatic
			Frequency (if automatic)	Cycles
			Hours	0 - 9999
	Analyzer Cell	Filament Selected		1 / 2
		Filament		Off / On
		Triode Pression		-
		Electric Zero		-
		Target Value		-
		Acceleration Voltage (V)		-
		Emission (mA)		-
		Sensitivity Coefficient		-
	Internal Temperature (°C)		-	
	Internal Pirani Calibration	Function launching		-
	External Gauge	Gauge		None / TPR / PCR / Linear
		External Pressure (mbar)		-
Pression Inlet Source		Internal / External		
Full scale (mbar) (if Linear)		0.1 - 50000		
Purge Valve		Automatic / Closed / Open	Automatic	

ADVANCED						
Selection				Choice - Setting limit	Initial settings	
Input/Output (I/O 15 pins)	Serial link 1	Type			Serial	Serial
		Parameters	Mode		Basic / Spreadsheet / Advanced / Data export / RC 500 WL / RC 500 / HLT 5xx / Ext. modul / HLT 2xx	Advanced
				Handshake	None / XON / XOFF	None
		Power Pin 9			-	5 V
	Serial link 2	Type			Not used	Not used
	I/O Connector	Analog Output	9-gnd	Allocation	<i>See Manual I/O 15 pins</i>	Mantissa
				Value	According to Allocation	-
			10-gnd	Allocation	<i>See Manual I/O 15 pins</i>	Logarithmic
				Value	According to Allocation	10^{-12}
			12-gnd	Allocation	-	Exponent
Value				$10^{+2} - 10^{-13}$	10^{-12}	
Input/Output (I/O 37 pins)	Serial link 1	Type			Serial / USB	Serial
		Parameters	Mode		Basic / Spreadsheet / Advanced / Data export / RC 500 WL / RC 500 / HLT 5xx / Ext. modul / HLT 2xx	Advanced
				Handshake	Aucun / XON / XOFF	Aucun
		Power Pin 9			-	5 V

ADVANCED Selection					Choice - Setting limit	Initial settings	
Input/Output (I/O 37 pins)	Serial link 2	Type		Not used / USB / Network		Not used	
		Parameters	Mode		Basic / Spreadsheet / Advanced / Data exports / HLT 5xx		Advanced
			Handshake		None / XON / XOFF		None
	I/O Connector	Quick View		I/O set in the 37 pins connector			
		Analog output	37-gnd	Allocation	See Manual I/O 37 pins		Mantissa
				Value	According to allocation		-
			36-gnd	Allocation	See Manual I/O 37 pins		Logarithmic
				Value	According to allocation		10 ⁻¹²
			19-gnd	Allocation	-		Exponent
				Value	10 ⁺² - 10 ⁻¹³		10 ⁻¹²
Digital input		11-gnd	Allocation	See Manual I/O 37 pins		Calibration	
			Activation	Rising edge / Falling edge / Impulsion		Impulsion	
		30-gnd	Allocation	See Manual I/O 37 pins		Sniffer test	
	Activation		Rising edge / Falling edge / Impulsion		Rising edge		
	12-gnd	Allocation	See Manual I/O 37 pins		Filament		
		Activation	Rising edge / Falling edge / Impulsion		Rising edge		
	31-gnd	Allocation	See Manual I/O 37 pins		GL mode		
		Activation	Rising edge / Falling edge / Impulsion		Rising edge		
	13-gnd	Allocation	See Manual I/O 37 pins		HV Test		
		Activation	Rising edge / Falling edge / Impulsion		Impulsion		
	32-gnd	Allocation	See Manual I/O 37 pins		Inlet vent		
		Activation	Rising edge / Falling edge / Impulsion		Rising edge		

ADVANCED							
Selection				Choice - Setting limit		Initial settings	
Input/Output (I/O 37 pins)	I/O Connector	Digital Transistor Output	9 - 28	Allocation	See Manual I/O 37 pins	Filament on	
				Activation	NO / NC	NO	
			8 - 27	Allocation	See Manual I/O 37 pins	Warning/Error	
				Activation	NO / NC	NO	
			7 - 26	Allocation	See Manual I/O 37 pins	Detector ready	
				Activation	NO / NC	NO	
			6 - 25	Allocation	See Manual I/O 37 pins	Filament #2	
				Activation	NO / NC	NO	
			Digital Relay Output	5 - 24	Allocation	See Manual I/O 37 pins	Sniffing Test
					Activation	NO / NC	NO
				4 - 23	Allocation	See Manual I/O 37 pins	GL Test
					Activation	NO / NC	NO
		3 - 22		Allocation	See Manual I/O 37 pins	HS Test	
				Activation	NO / NC	NO	
		2 - 21		Allocation	See Manual I/O 37 pins	HV Test	
				Activation	NO / NC	NO	
		1 - 20	Allocation	See Manual I/O 37 pins	Reject point		
			Activation	NO / NC	NO		
		Select Default Configuration	Function launching		-	-	
		Others Configurations				Config #1 / Config #2 / Config #3	-
		Load Config. from SD Card	Function launching		-	-	
		SD Card	Load LD Parameter	Function launching		-	-
			Save LD Parameter	Function launching		-	-
			Visualize *.BMP	Function launching		-	-
Service	Access to Menu Service with password. Only for Service Centers.						

Certification to UL 61010-1



AUTHORIZATION TO MARK

This authorizes the application of the Certification Mark(s) shown below to the models described in the Product(s) Covered section when made in accordance with the conditions set forth in the Certification Agreement and Listing Report. This authorization also applies to multiple listee model(s) identified on the correlation page of the Listing Report.

This document is the property of Intertek Testing Services and is not transferable. The certification mark(s) may be applied only at the location of the Party Authorized To Apply Mark.

Applicant:	PFEIFFER VACUUM SAS	Manufacturer:	PFEIFFER VACUUM SAS
Address:	98 avenue de Brogny - BP 2069 74000 Annecy Cedex	Address:	98 avenue de Brogny - BP 2069 74000 Annecy Cedex
Country:	France	Country:	France
Contact:	Mr Julien Coulomb	Contact:	Mr Julien Coulomb
Phone:	+ 33 4 50 65 75 39	Phone:	+ 33 4 50 65 75 39
FAX:	/	FAX:	/
Email:	julien.coulomb@pfeiffer-vaccum.fr	Email:	julien.coulomb@pfeiffer-vaccum.fr

Party Authorized To Apply Mark: Same as Manufacturer
Report Issuing Office: Intertek, Paris, France

Control Number: 3026716

Authorized by:

Ulla-Pia Johansson-Nilsson
for Dean Davidson, Certification Manager



This document supersedes all previous Authorizations to Mark for the noted Report Number.

This Authorization to Mark is for the exclusive use of Intertek's Client and is provided pursuant to the Certification agreement between Intertek and its Client. Intertek's responsibility and liability are limited to the terms and conditions of the agreement. Intertek assumes no liability to any party, other than to the Client in accordance with the agreement, for any loss, expense or damage occasioned by the use of this Authorization to Mark. Only the Client is authorized to permit copying or distribution of this Authorization to Mark and then only in its entirety. Use of Intertek's Certification mark is restricted to the conditions laid out in the agreement and in this Authorization to Mark. Any further use of the Intertek name for the sale or advertisement of the tested material, product or service must first be approved in writing by Intertek. Initial Factory Assessments and Follow up Services are for the purpose of assuring appropriate usage of the Certification mark in accordance with the agreement, they are not for the purposes of production quality control and do not relieve the Client of their obligations in this respect.

Intertek Testing Services NA Inc.
545 East Algonquin Road, Arlington Heights, IL 60005
Telephone 800-345-3851 or 847-439-5667 Fax 312-283-1672

Standard(s):	Safety Requirements For Electrical Equipment For Measurement, Control, And Laboratory Use – Part 1: General Requirements [UL 61010-1:2012 Ed.3+R:29Apr2016] Safety Requirements For Electrical Equipment For Measurement, Control, And Laboratory Use – Part 1: General Requirements (R2017) [CSA C22.2#61010-1-12:2012 Ed.3+U1;U2]
Product:	Mobile gas leak detector
Brand Name:	
Models:	ASM390 and ASM392

Certification to SEMI S2



Global Semiconductor Safety Services

CERTIFICATE OF CONFORMANCE

To SEMI S2-0715 and SEMI S8-0915 Guidelines

September 13, 2017

Company Name & Location:	Pfeiffer Vacuum 98 avenue de Brogny 74009 Annecy France
Place of Manufacturing:	Annecy, France
Document Number:	102846706MPK-003a
Model:	Helium Leak Detector, ASM 390
Investigated in accordance with:	SEMI S2-0715 / SEMI S8-0915

Intertek Global Semiconductor Safety Services



Declaration of conformity

We hereby declare that the product cited below satisfies all relevant provisions according to the following **EC directives**:

- **Machinery 2006/42/EC (Annex II, no. 1 A)**
- **Electromagnetic Compatibility 2014/30/EU**
- **Restriction of Hazardous Substances 2002/95/EC**
- **Waste of Electrical and Electronic Equipment 2012/19/EEC**

The technical file is drawn up by Mr Arnaud Favre, Pfeiffer Vacuum SAS, [simplified joint stock company], 98, avenue de Brogny · B.P. 2069, 74009 Annecy cedex.

ASM 390 / ASM 392

Harmonised standards and national standards and specifications which have been applied:

Standards NF EN-55011: 2009
Standards NF EN-61000-3-3: 2013
Standards NF EN-61000-3-2: 2014

Signature:

Pfeiffer Vacuum SAS
98, avenue de Brogny
B.P. 2069
74009 Annecy cedex
France

(Guillaume Kreziak)
Director of Products, Technology & Projects

01/04/2018

VACUUM SOLUTIONS FROM A SINGLE SOURCE

Pfeiffer Vacuum stands for innovative and custom vacuum solutions worldwide, technological perfection, competent advice and reliable service.

COMPLETE RANGE OF PRODUCTS

From a single component to complex systems:

We are the only supplier of vacuum technology that provides a complete product portfolio.

COMPETENCE IN THEORY AND PRACTICE

Benefit from our know-how and our portfolio of training opportunities!

We support you with your plant layout and provide first-class on-site service worldwide.

Ed 01 - Date 2018/02 - P/N: 1263480EN



Are you looking for a
perfect vacuum solution?
Please contact us:

Pfeiffer Vacuum GmbH
Headquarters • Germany
T +49 6441 802-0
info@pfeiffer-vacuum.de

www.pfeiffer-vacuum.com

PFEIFFER  **VACUUM**