

ALCATEL CIT

DIVISION VIDE ET MECANIQUE

55, rue Edgar Quinet

92240 MALAKOFF - FRANCE

Tél. : 16-1-40-42-30-00

Télex : 632033 F

ASM 110 TCL

HELIUM LEAK

DETECTOR

You have just received an **ASM 110 TCL** helium leak detector.

It has been delivered to you with :

- an electronic cabinet
- a connection cable
- a technical manual
- a maintenance kit
- a mechanical pump oil charge
- a funnel.

We hope that this unit will give you satisfaction.

ALCATEL CIT
H.L.D. Department

CONTENTS

1. CONDENSED MANUAL	
2. GENERAL	
2.1. General specification	1
2.2. Symbols	2
2.3. Operation specification of the ASM 110 TCL	3
2.4. Layout of the manual	4
3. ANALYSER BLOCK	
3.1. Analysis cell	1
3.2. High vacuum pumping unit	7
3.3. Roughing	9
4. ELECTRONIC CABINET	
4.1. Analyser	1
4.2. Safety inlet valve	1
5. OPERATING INSTRUCTIONS	
5.1. Description of analyser electronic	2
5.2. Description of frequency converter	3
5.3. Operation and adjustment	3
5.4. Adjustments	7
5.5. Available informations	8
6. OPTIONS	
6.1. Detector operation	1
6.2. Maintenance	9
6.3. Periodical maintenance operations	10
6.4. Trouble working	11
6.5. Spare parts kit	15
6.6. Maintenance kit	17
7. 51010 TMP	
7.1. Description	1
7.2. Technicals specifications	2
7.3. Utilization	3
7.4. Maintenance and servicing	4
8. OPTIONS	
8.1. Gross leak option	1
8.2. Other voltages	1
8.3. Long distance sniffer	2
9. ASM 110 TL VERSION	
9.1. Principle	1
9.2. Description	1
9.3. Performance	2
9.4. Directions for use	2

CHAPTER 1

CONDENSED MANUAL

CHAPTER 2

GENERAL

CONTENTS

2.1. General specification	1
2.2. Symbols	2
2.3. Operation specification of the ASM 110 TCL	3
2.4. Layout of the manual	4

2.1 GENERAL SPECIFICATION

Alcatel ASM 110 TCL is a complete portable leak station. It includes a gas analyser and a roughing system.

It comes in two separated units (figure 2) :

	GAS ANALYSER	ELECTRONIC CABINET
WIDTH	380 mm	230 mm (1/2 rack)
LENGTH	530 mm	250 mm (3 U)
HEIGHT	470 mm	150 mm
WEIGHT	53 kg	5 kg

POWER SUPPLY

220 V. - 50 Hz.	single phase	
115 V. - 60 Hz.	single phase (Option)	800 VA
100 V. - 60 Hz.	single phase (Option)	
240 V. - 50 Hz.	single phase (Option)	

OIL CAPACITY FOREPUMP





500 cc

2.2 SYMBOLS

2.21 GAS ANALYSER (figure 2)

LOCATION	SYMBOLS	SIGNIFICATION
Throttle valve		Opened Closed
Selector valve	Position 0 Position 1 Position 2 Position 4	Mechanical pump blanked-off Inlet port roughing Closed Loop circuit Direct reading detection
TMP information	Yellow light Green light Red light	< 27000 tr/mn = 27000 tr/mn Default

2.22 ELECTRONIC CABINET (standard, figure 5a)

LOCATION	SYMBOLS	SIGNIFICATION
Green light	< 10-2	Analysis cell pressure is 10-2 mbar
Green light		Filament on
Green light		Throttle valve is opened
		Sensitivity adjust- ment
		Audio signal volume control
		Audio signal thresh- hold
	"0"	Zero adjustment knob
		Recording output 50 mV
	He	Helium signal adjustment

2.3 OPERATION SPECIFICATION OF THE
ASM 110 TCL LEAK DETECTOR

- Maximum operating pressure of the analysis cell	10 ⁻⁴ mbar
- Pumping speed for He :	
- in front of the analysis cell	30 l/s
- at the inlet valve	8 l/s
- Intrinsic sensitivity of the analysis cell	3,5.10 ⁻⁴ A/mbar
- Variation of sensitivity as a function of pressure between 10 ⁻⁶ and 10 ⁻⁴ mbar	+40 % maximum
- Smallest detectable signal	2.10 ⁻¹¹ atm.cm ³ /s He
- Leak Rate Detection Range :	
- direct	2.10 ⁻¹¹ to 1.10 ⁻⁵ atm.cm ³ /s He
- closed loop circuit	1.10 ⁻⁵ to 3.10 ⁻¹ atm.cm ³ /s He
- Pirani gauge detection	1 to 100 atm.cm ³ /s He
- Response time :	
- scale 10.10 ⁻¹⁰	1,5 s
- scale 3.10 ⁻⁹	1 s
- scale 10.10 ⁻⁹ - 10.10 ⁻⁶	0,5 s
- Filament protection (triode)	off at 2.10 ⁻⁴ mbar
- Turbomolecular pump protection (Pirani gauge)	Closing of the safety inlet valve at 5.10 ⁻² mbar
- Audio signal	Adjustable on the whole range
- Air roughing pumping speed at the inlet port	1 l/s

Note :

1 mbar = 0,75 Torr

1 mbar = 100 Pascals

1 Torr = 1 mm Hg

2.4 LAYOUT OF TECHNICAL MANUAL

ASM 110 TCL detector is made of two parts :

- An "analyser block" which contains the main part of the equipment : the analysis cell with its high vacuum pumping station, the general electric circuits, the roughing station and the converter.

- An "electronic cabinet" with the control and the signal-lights.

Note : There is 2 types of electronics cabinet :

- one with display by needles galvanometers and ranges manual commutation : we'll name it "old electronic".

- one with display by electroluminescente rise and ranges automatic commutation : we'll name it "new electronic".

In this document, we shall study :

- The "analyser block" chapter 3
- The general electric circuits chapter 4
- The "electronic cabinet" chapter 5

More, we shall find :

- The operating instructions chapter 6
- TMP 5101 chapter 7
- The options chapter 8

CHAPTER 3

ANALYSER BLOCK

CONTENTS

3.1. Analysis cell	1
3.2. High vacuum pumping unit	7
3.3. Roughing	9

3.1 ANALYSIS UNIT

3.1.1 Operating principle

Detection of Helium is made by means of a mass spectrometer analysis cell tuned for the mass of Helium ($m/e = 4$), or a light mass ($m/e = 2$ or 3).

m/e : atomic weight of the particle / number of electrons lost in ionization.

The principle of magnetic deflection spectrometers is as follows.

The neutral molecules of the gas to be analysed pass into an ionization chamber (or ion source) where they are bombarded by an electron beam emitted by a heated tungsten filament. A considerable part of the molecules are converted into ions. The ionized particles are then accelerated by an electric field.

The analysis tube is subjected to a magnetic field which bends the ion paths along different radii, according to the mass of ions (or more precisely, according to the m/e ratio). Thus, the ion beam which containing only ions of same m/e ratio. The helium ions ($m/e = 4$) are separated from the lighter ions ($H + 2$ and $H + 1$ of lesser radius) and heavier ions ($N + 2$ and $O + 2$ of greater radius).

With a constant magnetic field (permanent magnet), the accelerating field is adjusted so that the helium ions ($m/e = 4$) follow a specific path (passage through diaphragms) and strike the target placed at the entrance of a direct current amplifier.

The helium ion current is proportional to the partial helium pressure in the installation and its measurement makes it possible to determine the value of the flow of the leak detected.

The total pressure in the analysis cell must be less than 2×10^{-4} mbar so that the electron and ions paths are not disturbed by residual molecules. But the risk of damage to the heated filament only begins at about 10^{-3} mbar.

Note 1 :

To obtain proper separation of the helium ions from the "noise" due to "scattered ions", an electrode placed in front of the target eliminates the secondary ions of low energy. This electrode is called "repeller".

Note 2 :

An auxiliary electrode in front of a plate is located at the top of the tube. This electrode collects the ions having a greater mass than the helium ions. This electrode thus permits measurement of the total pressure in the analyser without using a Penning gauge. (When measuring signals of very low value, it is not advisable to use a Penning gauge which is a source of helium noise). This electrode acts as the plate of a triode gauge, hence the name "triode electrode".

3.12 Construction

The analysis cell has been carefully constructed in order to obtain a high degree of reproducibility of characteristics and good stability :

- Metal parts of stainless steel
- Filament holder of machined alumina
- Built-in pre-amplifier.

The analysis cell assembly (fig.7) mainly consists of :

- a. A vacuum or deflection chamber
- b. A lens holder flange
- c. A permanent magnet
- d. A pre-amplifier.

a. The vacuum chamber of the analysis cell is made of a light alloy. It has a rectangular opening into which fits the entire electrodes set attached to the "lens holder flange".

b. The lens holder flange serves as a support for the electrodes set and electric feedthroughs of the cell. It includes :

- A power feedthrough socket mounted with a metal seal
- A pre-amplifier mounted with a metal seal
- A solid block for the target mounting and shielding
- An ion source consists of two parts :
 - . a filament holder
 - . a ionization chamber with a stainless steel electron collector and a massive ion emitter.

The filament holder mechanically positions the tungsten filament with respect to the ionization chamber.

The electron collector and the filament are constructed and arranged in such a way that the temperature of the electron collector stabilizes at 400 °C through electron bombardment and filament radiation. The cell is therefore made impervious to contamination due to tested articles impurities, without having to use a special heating system.

c. The permanent magnet which creates the deflective magnetic field. It consists of :

- the permanent magnet itself
 - 2 machined pole parts which are attached to the magnet by araldite.
- These parts should never be detached from the magnet.

One pole is marked N.

Note :

Following disassembly of unit, care must be taken to properly reposition the magnet (pole part N in the back).

d. The pre-amplifier (fig. 9) is mounted on a 12 pins feedthrough socket and consists of :

- 2 electrometer tubes
- 1 resistor (8.1011 Ω)
- 1 target.

These parts form a rigid assembly which cannot be disassembled and should not be touched with the fingers.

3.13 Maintenance

There are three normal maintenance operations to be carried out on the analysis cell :

- Replacement of the filament
- Cleaning of the ion source cell
- Cleaning of the entire analysis cell.

3.131 Replacement of the filament

Replacement of the filament requires only partial disassembly of the analysis cell. Replacement is carried out in the following manner :

- Turn the leak detector off.
- Disconnect the two Jaeger plugs of the analysis cell
- Unscrew the six screws (socket wrench)
- Remove the lens holder flange (the gasket cannot be re-used) and place it on a very clean sheet of white paper
- Unscrew the filament holder screw and remove the filament.

To install a new filament, the above operations are carried out in the reverse order.

When these operations are being carried out, care should be taken not to touch the internal parts of the analysis cell with fingers.

Remarks :

1. Visually check to make sure the filament is correctly placed in front of the slot of the ion source. If necessary, change the position of the collector by slightly loosening its two fixing screws.

2. The tungsten filament, which is hardened by a special heat treatment, is fragile. It should never be touched. Handle the filament holder with pliers.

3. To replace the metal gasket, use lead wire 0,8 mm in diameter and clean it with alcohol. Form a rectangular loop with the wire by overlapping the two ends at one of the corners :

- carefully place the gasket horizontally on the vacuum chamber
- carefully lower the lens holder flange vertically into place
- gradually tighten the screw, a little at a time, do not completely crush the washers.

Note :

The use of pure lead is not recommended. Use common fuse wire, a shiny lead/Antimony alloy, which makes it easier to obtain airtightness.

Tools :

- A socket wrench for size 5 mm allen screws
- A 2,5 mm screwdriver
- A pair of Precelle pliers

3.132 Cleaning of the ion source supply only

Cleaning is only carried out when there is a loss of sensibility. The lens holder flange is removed as indicated in § 3.131. After having removed the filament, the electron collector is removed. The collector is cleaned as indicated in § 3.133 below. In particular, the inlet slot and the electron impact surface should be cleaned. Preferably, this collector should be replaced by our standard replacement.

Tools :

The same as in § 3.131.

3.133 Cleaning of the entire analysis cell

Cleaning of the entire analysis cell is only required under exceptional conditions (flash, generalized contamination resulting in insulating deposition film). This operation should be carried out with the greatest care (cleanliness, cleaning, degassing, etc...).

The user must :

- Carry out the operation in a very clean room in which there is a working surface covered with clean white paper.
- Don't touch the electrodes with fingers during the disassembly.

Disassembly :

1. Begin this operation as was indicated for replacement of the filament, then :
2. Disconnect the triode electrode
Disconnect the repeller electrode
3. Disconnect other parts.

Cleaning :

All the parts are cleaned in a bath consisting of :

- 50 % ethyl alcohol
- 50 % ethyl acetate, then rubbed and dried with paper.

If necessary, use abrasive cloth to remove the insulating particles from the metal pieces of the analysis cell and the vacuum chamber.

Rassembly is carried out by performing the above operations in the reverse order, without touching the parts with the fingers. Reinstall the alumina spacers and properly center them.

Tools for disassembly of the analysis cell :

- 1 pair of Precelle pliers
- 1 x 5 mm allen key
- 1 x 2,5 mm screwdriver
- 2 aluminium gaskets
- 0,8 mm diameter lead wire.

Note 1 :

We have already seen that the electrodes can normally be cleaned and the filament replaced without removing the vacuum chamber. Should this however prove to be necessary, the operation will be carried out in the following manner :

- Disconnect the two Jaeger plugs of the cell
- Remove the 4 cell fixing screws

- Pull out the analysis cell assembly.

Rassembly :

- Fix the analysis cell with the 4 screws.

Note 2 :

After having opened the analysis cell, make sure the gaskets are airtight by using the detector itself.

3.134 Troubles

3.134.1 Filament breaking

This trouble is easy to detect. By means of a calibrated leak, it can be found that the detector no longer generates a signal and that the "filament" light is out.

By checking the Jaeger plug with an ohmmeter, an open circuit will be measured (broken filament) between contacts 1 and 5.

Causes :

In general, filament burn out due to wear resulting from successive air inrushes. It will then be noted that there is a deposit of blue or yellow powder on the electron collector due to evaporation of the tungsten.

Corrective measures :

The filament must be replaced (see § 3.131). If the filament has produced a flash, the ion source must be cleaned before a new filament is installed.

3.134.2 Contamination of the analysis cell

There are two indications of contamination :

1. Due to outgassing, the filament goes off automatically when being switched on
2. A loss of sensibility (ratio 2 or 3).

Corrective measures :

The analysis cell is cleaned according to the procedure described in § 3.132 or 3.133.

Note :

Loss of sensitivity can also be caused by deformation of the filament. It is possible to recenter the filament in front of the electron collector, thus avoiding having to replace the filament.

3.2 HIGH VACUUM PUMPING UNIT

The high vacuum unit consists of :

1. One air cooled turbomolecular pump
 - As backing pump for the turbomolecular pump
 - As roughing system, through the three-way ball valve.
2. One mechanical forepump used
3. One Pirani gauge head

3.21 Turbomolecular pump

3.211 Operating principle and construction

High vacuum is obtained ($<10^{-4}$ mbar) by means of an air cooled turbomolecular pump (see chapter 7 "5101 TMP"), and is controlled by a frequency converter located on the bottom of the analyser, near the roughing pump (see picture 3).

3.212 Maintenance

Dismantling :

- Remove the leak detector cover.
- Remove the flexible tube of the TMP.
- Remove the connector.
- Unscrew and remove the four pump fixing screws (under the frame).

Regular maintenance :

See maintenance and operating in chapter 7.

3.22 Forepump and foreline

The TMP exhaust is connected to the mechanical pump inlet (see 3.32) by a flexible metallic tube when the valve is on indication 4 (see fig. 1).

3.23 Pirani gauge

3.231 Operating principle

The Pirani gauge is a thermic manometer : the temperature of a wire heated by an electric current depends on the pressure.

The pressure measurement is carried out by measuring the resistance of the metallic wire (hence its temperature and the pressure).

The Pirani gauge has 3 functions :

1. It shows that the pressure in the analyser is lower than $5 \cdot 10^{-2}$ mbar, by means of a green light " 10-2" located on the electronic cabinet.
2. It only starts the TMP if the pressure is lower than $5 \cdot 10^{-2}$ mbar.
3. It prevents the filament from being energized if the pressure exceeds $5 \cdot 10^{-2}$ mbar.

Note :

The leak detector filament has its own protection device controlled by the triode electrode current.

3.232 Construction

The Pirani filament is located in a glass tube mounted on a stainless steel flange.

3.233 Maintenance

The Pirani gauge is cleaned with an alcohol/acetone solution after every 4000 hours of operation.

Disassembly and cleaning of the gauge head :

This operation must be carried out when the equipment is not operating. The gauge head is connected to the block by a quick disconnect clamp with Buna o-ring :

- Disconnect the gauge power cord
- Remove the gauge
- Rinse the gauge head with an alcohol/acetone solution.
The filament is replaceable (part number A 057 972).

3.3 ROUGHING

3.31 Description

This unit is used to rough the inlet valve and the inlet line to a pressure of 10⁻³ mbar.

The roughing unit consists of two major parts :

- one vane pump model 2004 A (4 m³/h) and its connection to the inlet valve and the TMP exhaust.
- an electromagnetic safety valve.

3.32 Mechanical pump

3.231 Construction

The mechanical pump used is a 2004 A (4 m³/h) model.

This pump is used to evacuate the inlet valve for pieces whose volumes don't exceed 50 liters. For larger volumes, it is better to use an auxiliary roughing pump (see picture 1).

3.232 Maintenance

Dismantling :

- Remove the leak detector cover.
- Remove the ball-valve and the flexible tubes.
- Disconnect the motor.
- Unscrew and remove the four pump fixing screws (under the frame).

Regular maintenance :

- See maintenance and operating instruction manual.

3.33 Three-way ball valve 4 positions

This valve is a four position valve with different functions :

- Position 0 : Mechanical pump isolated.
- Position 1 : Connects the MP with the inlet for roughing.
- Position 2 : Connects the MP, inlet and TMP exhaust in the closed loop circuit.

- Position 4 : Connects the MP and TMP exhaust for direct detection.

3.331 Description

See picture 12.

3.332 Maintenance

No special maintenance operation must be performed : the valve is disassembled and cleaned whenever general maintenance is carried out on the leak detector.

3.34 Inlet valve

3.341 Introduction

This bellows-type valve (Rep. 3) protects the analyser from accidental air inrush. It also allows to work by throttling.

3.342 Description

This valve is represented in figure 10.

3.343 Operation of the safety device

This is not a conventional electromagnetic valve. It opens manually and closes automatically. Its driving shaft is divided in two parts. The first one carries the electromagnetic coil. The other, a disk which closes the magnetic circuit.

The coil power is controlled by the Pirani gauge. The pressure must be 5.10^{-2} mbar for the coil to be energized. To open the valve, the operator must first turn the valve control knob clockwise (which will bring the 2 disks into contact ; then he must turn the knob counter-clockwise).

3.344 Maintenance

There isn't a special maintenance operation to be performed. The valve is disassembled and cleaned whenever general maintenance is carried out on the leak detector.

In particular, maintenance will be required if the pressure in the analyser is higher than 5.10^{-5} mbar (with the detector inlet blanked off). Such maintenance will only be needed after 4000 or even 10000 hours of operation, if the detector operates on clean articles.

CHAPTER 4

ELECTRICAL WIRING

CONTENTS

4.1. Analyser	1
4.2. Safety inlet valve	1

4.1 ANALYSER

The power supply controls are located in the electronic cabinet.

The on-off switch, with circuit breakers, is located on the front panel. It controls and protects the leak detector (6/8 A for 220 V. or 8/10 A for 115 V.).

There is also a time counter.

A blower cools the turbomolecular pump. It should be cleaned every 2000 hours and replaced after 20000 hours.

4.2 SAFETY INLET VALVE (figure 10)

- Rating : 7 volts - DC
- Voltage between P08. 1 and P08. 2 = 1,2 V.

A micro-switch in the valve monitors the valve opening.

CHAPTER 5

ELECTRONIC CABINET

CONTENTS	
5.1. Description of analyser electronic	2
5.2. Description of frequency converter	3
5.3. Operation and adjustment	3
5.4. Adjustments	7
5.5. Available informations	8

The ASM 110 TCL electronic circuits are located in a portable cabinet connected to the vacuum unit by means of a cable.



This arrangement has several advantages :

- Easy to carry.
- The solid state electronic cabinet temperature is not affected by the vacuum pumps heat.
- The portable control cabinet allows the operator to read both the total pressure and the helium partial pressure.

5.1 DESCRIPTION OF ANALYSER ELECTRONIC

5.1.1. "Old" electronic (standard, figure 5a)

On the cabinet front panel are located :



- the leak meter (ref. 1)
- the total pressure gauge meter (ref. 2)
- the range selector (ref. 3) and the sensitivity adjustment potentiometer (ref. 4)
- 3 pilot lights (green) with the following engravings :
 - . 10-2 indicates that the pressure in the analyser is below 10-2 mbar (ref. 5).
 - .  indicates the filament is on (ref. 6).
 - .  indicates the inlet valve is opened (ref. 7).
- the helium peak adjustment potentiometer (ref. 8)
- the two controls of the audio signal :
 - . volume (ref. 9)
 - . alarm threshold adjustment potentiometer (ref. 10).
- the zero adjustment potentiometer knob and the two recorder output sockets (ref. 12). Green socket is ground.

At the rear of the cabinet are located :

- the cabinet to vacuum unit connection cable socket
- the protection fuse
- a socket for connection to a fast test station (DGC) or to a remote meter.

5.1.2. "New" electronic (option, figure 5b)

On the cabinet front panel are located :

- Helium signal (ref. 1) : decimal value of 0 to 10 by step of 0,1.
- Exponent value (ref. 2).
- Switchs managing ranges (ref. 3) :
 - . selection of automatic/manual range commutation (ref. 4)
 - . range increase  (ref. 5)
 - . range decrease  (ref. 6)

- ∇ light (ref. 9) indicates opened or closed state of the sampling valve.
- Extinguishing (ref. 10) or switching on (ref. 11) of emission in analyser with filament state repetition by green light.
- Audio volume adjustment (ref. 12).
- Audio signal releasing threshold adjustment (ref. 13).
- Zero adjustment potentiometer (ref. 14).
- Sensibility adjustment potentiometer \curvearrowright (ref. 15).
- Helium peak adjustment potentiometer \mathcal{A} (ref. 16).
- Recording sockets : 0 to 10 V (Ref. J1 and J2).

Note : In 3 mass option :

- commutator (ref. 17)
- mass 2 sensibility adjustment \curvearrowright (ref. 18)
- mass 2 peak adjustment \mathcal{A} (ref. 19)
- mass 2 light (ref. 22)
- mass 3 sensibility adjustment \curvearrowright (ref. 20)
- mass 3 peak adjustment \mathcal{A} (ref. 21)
- mass 3 light (ref. 23)
- mass 4 light (ref. 24).

5.2 DESCRIPTION OF FREQUENCY CONVERTER

See Chapter 7 : TMP 5101.

5.3 OPERATION AND ADJUSTMENT

The electric diagram of the "old" electronic cabinet is shown on the drawing A 106 92.

5.3.1. Amplifier card E 01

The following functions are gathered on this card.

+ Tube electrometer preamplifier bias

This bias is ensured by the R 8, R 101, R 102 and R 7 bridge. The R 101 and R 102 potentiometers enable the tube electrometer preamplifier balance.

+ Amplifier

The tube electrometers anodes are connected to the Z 16 differential amplifier. The Z 16 output signal is amplified by Q 1 and Q 4 applied to the display circuits through a R 41 to R 46 resistance attenuator, controlled by the scaling card (E 03) relays.

+ Audio alarm

The amplifier output voltage is applied to the comparator made up of Q 5 and Q 6. The threshold is adjusted by R 25. The comparator output controls the oscillator. Thus, the audio frequency fluctuates according to the leak signal value.

The Q 2 and Q 9 amplifiers amplify the oscillator signal, and enable to launch a loudspeaker, the audio volume being adjustable by R 24.

5.3.2. Power supply card E 02

This card performs the following functions.

+ Cell polarization voltage generation

These voltage are generated from a 380 V reference voltage, insensitive to temperature or mains voltage conditions.

This voltage is obtained by hatching, then by filtering a 2 x 180 V voltage thanks to both CR 52 and CR 53 opto-triacs.

These triacs are controlled by the Z 2 phase controller circuit, which is the main servocontrol element. This voltage can be measured on TP 1 and TP 2 and adjusted by actuating R 12i.

This 380 V voltage supplies a R 112 - R 113 - R 114 - R 115 and R 116 resistors bridge, generating :

- the acceleration voltage : between mass and TP 2, this voltage is adjustable on the front face by helium peak potentiometer (A).

- the bracking voltage fixed voltage of about 40 V between TP 2 and R 117.

The 120 V filament bias voltage is achieved by the 200 V CR 58 diode (120 - 320 - 200).

+ Filament heater current control

The cell filament is connected to the electronic box by means of the J 01 plug between terminals 19 and 22.

The heater current is supplied by the T 01 transformer 2 x 10 V winding through the Q 15 transistor.

The K 01 11 - 10 contact enables to heat the filament if the pressure conditions are fulfilled.

The CR 4 led parallel on Q 15 is the filament operating pilot.

The heater current is controlled so as to continuously maintain the electronic current emitted by the filament.

The R 27 potentiometer enables to adjust this current value, which can be measured at the R 125 terminals (1 k Ω), by connection on the red and green connectors of the printed circuit. The A 2 amplifier and the Q 20 transistor amplify the control current, and monitor the Q 15 ballast transistor.

+ Security in case of cell short circuit

A short circuit can appear in the cell between the filament and the electrons collector.

It can be cause to a normal phenomenon of burning.

In this case, the electronics circuits are protected principally by R 137 and R 138 thermistors.

+ Pressure safety

A Pirani gauge situated in the sensing cell or close by, enables to protect the cell in case of excess pressure.

the Pirani gauge filament is included in the R 57 - R 58 and R 59 Wheastone bridge.

The signal to the bridge terminals is amplified by Z 18. At the amplifier output, the Q 12 transistor controls the K 02 relay.

K 02 shifts to working position, as soon as the pressure in the analyzer is inferior to $5 \cdot 10^{-2}$ mbar.

the K 02 relay permits the contact cell (10 - 11) filament to be turned on and supplies the contact safety valve (4 - 5).

5.3.3. Scaling card E 03

This card is in your detector if you have a detector with the "new" electronic, equipped following 8430-005

This card performs the following functions.

+ Sealing

The helium signal stemming from the amplifier card, is applied to the input of 2 comparators by 2 A 1 amplifiers.

For the top threshold comparator, its value is adjusted by R 52 (output on J 1) to 95 % of the full scale, or a - 0,97 volt voltage.

For the bottom threshold, its value is adjusted by R 51 (output on J 2) to 5 % of the full scale, or a - 0,005 V voltage.

When the signal is inferior to the bottom threshold, the meter is on count down position.

The meter output controls the Z 6 decoder which monitors the K 1 to K 5 relays, commutating the E 01 amplifier card negative reaction and returns loss resistors.

This same meter output is converted into BCD data by Z 7 memory. Besides, this memory receives the data stemming from switches or from external controls, in order to display the exponent corresponding to the actual leak signal coming into the apparatus.

This description corresponds to an automatic mode operation.

In manual mode, the K 6 relay routes both scales selection switches onto the meter control logic.

+ Helium signal formatting

The helium signal stemming from the amplifier card, is impedance adapted by the A 1 amplifier, this amplifier output launches 2 amplifiers :

- 1 amplifier enabling to obtain the 0 - 10 V output for recording

- 1 formatting circuit made up of 3 A 3 amplifiers, which allows to launch the display circuit with a voltage fluctuating from 1,79 volt to 3,85 V, the display "0" adjustment being performed by R 50.

5.3.4. Mother board card

This card is in your detector if you have a detector with the "new" electronic, equipped following 8430-005

+ T 01 transformer

This transformer supplies all the voltage required for the operation of the box. The primary voltages may be selected amongst the following voltages : 100 - 115 - 200 - 220 - 240 V, using jackplugs for the selection on the card.

+ Power supply circuits

A Z 2 regulator enables to generate the +/- 15 V voltages for the scaling card. A Z 1 regulator creates the + 5 V voltage for the scaling card logic.

+ Filament heating power circuit

The Q 15 ballast transistor and the filament supply rectification diodes bridge, are mounted on the lateral side of the box. This unit is connected to the mother-board card by a 5-pin plug (J 5).

5.3.5. Display card E 04

This card is in your detector if you have a detector with the "new" electronic, equiped following 8430-005

This card, parallel to the front face, holds all the front face components.

+ Helium signal display card

- Display of the mantissa

The helium signal mantissa is displayed on a Z 18 bargraph. This 100 bars graph is controlled by a 10 x 10 multiplex system A x 100 counter (Z 4) alternatively controls each one of the 10 bars inside each one of the 10 sections.

The controls are performed through the Z 8 - Z 9 and Z 10 buffers, which switch the 35 V voltage over to the electrodes of the ramp.

An analog-to-digital converter (Z 3) transforms the input analog voltage (helium signal) into a strobe, the duration of which is proportional to the signal amplitude. During the time of this strobe, the segment lighting is permitted through Z 5 and Z 6.

The readout filament heating voltage is generated by the T 01 transformer. The CR 12 and CR 15 self-bias circuit, enables to determine the filament mid-point potential to about 5 V, which ensures the display segments correct extinction, when there is no control.

- Display of the exponent

Two decimal readouts are also installed on the E 04 card. They are controlled by the Z 8 decoder and the Q 1 transistor situated on the range swapping card (E 03).

+ Triode pressure display circuit

The signal stemming from the power supply card E 02 is adapted by the Z 11 differential amplifier, and controls the CR 8 and CR 9 light-emitting diode ramps both Z 12 and Z 13 monitoring circuits.

+ Scaling control switches

Three switches are located on the front face next to the exponent readouts. The locked position and green led fitted switch, enables to select either the automatic switching (depressed position and green diode lit up), or the manual switching (released position and diode extinguished).

In manual position, both push-buttons marked Δ and ∇ enable to increment or to decrement the exponent.

+ Control of the filament

The green diode fitted push-button enables to light up the filament, the diode duplicating the filament condition.
The push-button located to the previous one, enables to extinguish the filament.

+ Sensitivity and helium peak adjustments

Two screwdriver slit provided potentiometers are located under the filament control push-buttons.

The first potentiometer () enables to adjust the sensing cell electronic current value, and thus the sensitivity.

The second potentiometer () enables to adjust the acceleration voltage, which adjusts the helium peak.

+ Recording terminals

Two 2 mm dia. connectors, enable to connect a recorder. The black connector corresponds to the earth, and the red connector is the output signal hot point. This output supplies a voltage fluctuating from 0 to 10 V, and corresponds to the helium signal mantissa.

The internal impedance of this output is 600 Ω and it is short-circuit proof.

+ Audio alarm threshold and volume adjustments

Two screwdrivers slit provided potentiometers are installed next to the filament control push-buttons.

The potentiometer marked  controls the audio alarm volume.

The potentiometer marked  enables to adjust the audio alarm triggering threshold.

+ "0" adjustment

The potentiometer fitted with a black knurled knob marked "0" enables to adjust the "0" signal.

This potentiometer adjusts the signal amplifier voltage deviation on the E 01 card.

5.4. ADJUSTMENTS

5.4.1. Amplifier

L 101 anode voltage is adjusted at 8 V. by R 102 (E 01 printed board left).

Set zero of the amplifier with R 101, "0" potentiometer being placed two turns from full rotation.

5.4.2. Audio signal

Threshold adjustment by R 103 (see § 6.13).

5.5. AVAILABLE INFORMATIONS

5.5.1. "Old" electronic

At the back of the ASM electronic unit the following information is available on the 12 pins socket :

1. Triode pressure
2. Filament
3. Filament
4. Throttle valve
5. Throttle valve
6. Audio signal
7. Signal amplifier - Remote meter
8. Mass
9. Threshold 10-2
10. Threshold 10-2
11. Coil power-supply of the inlet valve

5.5.2. "New" electronic

Pin	Signal
1	Mass referenced (terminal 8) triode pressure (level 0 to 3 V)
2	+ Filament pilot light
3	- Filament pilot light
4	- Valve pilot light
5	+ Valve pilot light
6	Mass referenced, frequency-modulated audio alarm (level 0 - 5 V)
7	Analogous mass referenced helium signal (0 to - 100 volts)
8	▲ Analogous mass
9	- Pilot light 10-2
10	+ Pilot light 10-2
11	Safety valve supply with respect to the analogous mass (level 0 - 2 V)
23	A Analogous mass referenced exponent unit BCD outputs (level 0 - 5 V)
12	B Analogous mass referenced exponent unit BCD outputs (level 0 - 5 V)
24	C Analogous mass referenced exponent unit BCD outputs (level 0 - 5 V)
13	D Analogous mass referenced exponent unit BCD outputs (level 0 - 5 V)
25	A Logic mass referenced exponent decade BCD outputs (level 0 - 5 V)
20	Analogous mass referenced helium signal mantissa (level 0 - 10 V)
22	Entry data enabling to incremente the bi-decade exponent, mass link if active (coming from the GF valve data opened on ASM 151 T)
21	Entry data enabling to decremente the single decade exponent, mass link if active (coming from the HS detection data opened on ASM 151 T)
36	Auto/manual control for scaling mass link for auto
35	Scale incremente control, mass link for activation
15	Scale decrementation control, mass link for activation

Pin	Signal
37	Mass referenced triode pressure (level 0 - 10 V)
32	Analogous mass
33	Helium signal 0 - 50 mV
31	Logic mass referenced un-regulated + 5 V
28	Acceleration voltage (180 V to 260 V) (connection to be made onto mother-board card)
27	Logic mass referenced un-regulated + 39 V
29	+ Electronic current measure Non mass referenced (connection to be made onto mother-board card) (level 0 to 2 V)
30	- Electronic current measure Non mass referenced (connection to be made onto mother-board card) (level 0 to 2 V)

CHAPTER 6

OPERATING INSTRUCTIONS

CONTENTS

6.1. Detector operation	1
6.2. Maintenance	9
6.3. Periodical maintenance operations	10
6.4. Trouble working	11
6.5. Spare parts kit	15
6.6. Maintenance kit	17

6.1 DETECTOR OPERATION

6.11 Start-up

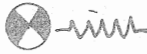
OPERATION	LOCATION
1. Check the voltage before plugging in (220 V. 50 Hz or 115 V. 60 Hz).	Electronic cabinet (rear) Main unit (rear)
2. Connect the main cable between the main unit and the electronic cabinet.	Electronic cabinet Main unit
3. If you have an "old" electronic, set the leak range selector knob to the 10.10-6 scale. If you have a "new" electronic, select this range with 4, 5 and 6 switches (fig. 5b).	Electronic cabinet
4. Push the green button on the main unit. <u>Note</u> : As the forepump starts, the display signals can be unstable.	Main unit
5. Turn the selector valve to position 4 (the mechanical pump roughs down the turbomolecular pump).	Main unit
6. After a few minutes, the " $< 10^{-2}$ " pilot indicator will light and the TMP is activated, indicated by a yellow pilot indicator on the main unit.	Electronic cabinet
7. When the green indicator on the main unit is lit, the turbo is at operational speed and the filament can be switched on by triggering the switch marked "  ". The green filament indicator illuminates.	Electronic cabinet
8. The pressure on the triode gauge will be about 10^{-4} mbar and will gradually drop to 10^{-5} mbar.	Electronic cabinet
<u>Note</u> : If the filament flashes and does not stay on, wait a few	Electronic cabinet 

OPERATION	LOCATION
<p>more minutes and try to activate the filament again.</p> <p>9. Unit is ready for operation.</p>	

6.12 Leak rate calibration

It is not necessary to calibrate the unit before each test, but it is advisable to test the calibration periodically. The calibration can be affected by accidental air in-rushes and errors by the operator. Calibration is made with a standard leak. Proceed as follows.

OPERATION	LOCATION
<p>1. Connect the standard leak to the inlet port. If the standard leak is equipped with a valve, open the valve at this point.</p>	Main unit
<p>2. Set the range to 10.10-9 scale. Use the "0" adjust knob to zero the leak rate meter.</p>	Electronic cabinet
<p>3. Set the range on the appropriate scale for calibrated leak which you are using (3.10-7), or in automatic if you have a "new" electronic".</p>	Electronic cabinet
<p>4. Turn the four-position valve knob to position 1. The mechanical pump will begin to gurgle, the pressure in on the Pirani gauge will decrease.</p>	Main unit
<p>5. Wait until the inlet pressure is $\approx 2.10^{-1}$ mbar and set the three-way valve to position 2.</p>	Main unit
<p>6. Slowly open the throttle valve (marked position 3). Check the triode (high pressure) gauge needle stays in the green zone. The green "✓" indicator will light as soon as the valve is open.</p>	Main unit Electronic cabinet
<p>7. If the triode pressure stays in the green zone, turn the selector valve to position 4.</p>	Electronic cabinet Main unit

OPERATION	LOCATION
<p>8. Read the helium leak rate value. The measured value will slightly decrease for a few minutes because of the helium memory effect.</p> <p>Notes about "old" electronic : The figures on the range selector correspond to the full scale deflection of the meter on that scale.</p> <p>Ex : $10 \cdot 10^{-9}$ will be read on the top scale (0-10). $3 \cdot 10^{-9}$ will be read on the bottom scale (0-3). To read a signal of $5 \cdot 10^{-8}$, the range selector should be on the $10 \cdot 10^{-8}$ scale and it would be in the center of the scale. A 30 % error can be allowed between the reading and the value on the standard leak.</p>	Electronic cabinet
<p>9. Use the emission current potentiometer "  " to bring the signal to the proper value.</p>	Electronic cabinet
<p>10. Use the helium peak potentiometer "He" to bring the signal to its peak value. There will only be one peak signal throughout the range of this potentiometer.</p>	Electronic cabinet
<p>11. Repeat steps 9 and 10 until the peak value corresponds to the calibrated leak value.</p>	
<p>12. The valve on the calibrated leak can be closed and opened again to verify the signal is actually helium. The throttle valve can be closed and the calibrated leak removed. The unit is now ready for testing.</p>	Main unit

OPERATION	LOCATION
1. With the filament off, turn the range selector to the 10.10-9 range.	Electronic cabinet 
2. Using the zero adjustment "0", adjust the helium signal needle to the equivalent signal which will be reject level. This is a mechanical set point on the galvanometer.	Electronic cabinet
3. Turn the volume potentiometer fully clockwise.	Electronic cabinet
4. Using the adjustment screwdriver, turn the threshold potentiometer until the signal is barely audible.	Electronic cabinet
5. Bring the needle back to zero.	Electronic cabinet

6.14 Testing a piece under vacuum

OPERATION	LOCATION
1. With the throttle valve closed, connect the piece to be tested to the inlet of the leak detector.	Main unit
2. Set the range selector to the 10.10-6 range.	Electronic cabinet
3. Move the selector valve to position 1. The mechanical pump will begin to gurgle and the pressure in the inlet port will decrease. If we use a repetitor, put the range on 3.10-7 (or in automatic commutation for "new" electronic).	Main unit
4. When the inlet pressure reaches $\leq 2.10^{-1}$ mbar, move the selector valve to position 2.	Main unit

OPERATION	LOCATION
5. Slowly open the throttle valve (Position 3). The triode gauge needle should remain in the green zone.	Main unit Electronic cabinet
6. If the throttle valve can be opened fully, move the selector valve to position 4.	Electronic cabinet
7. Move the range selector to the lowest possible range. Background helium may limit the minimum detectable leak.	Electronic cabinet
8. The leak test can be performed at any time once the selector valve is in position 2 or if the throttle valve is opened. The most sensitive method is with the throttle fully opened and the selector valve in position 2.	Main unit
If tests are to be performed on a series of parts or very large volumes, it is recommended to use an auxiliary mechanical pump to enhance rough down procedures.	
9. When the test is finished, move the selector valve to position 4 and close the throttle valve. Break the vacuum at the inlet port.	Main unit

6.15 Performing a leak test operation

6.151 Testing leaks from 2.10-11 to 1.10-3 atm.cc/s

See paragraph 6.14.

6.152 Testing leaks from 1.10-3 to 2.10-1 atm.cc/s

OPERATION	LOCATION
1. With the throttle valve closed, connect the piece to be	Main unit

OPERATION	LOCATION
2. Set the range selector to the 10.10-6 range.	Electronic cabinet
3. Move the selector valve to position 1. The mechanical pump will start to gurgle and the inlet pressure will begin to decrease.	Main unit
4. When the inlet pressure reaches $\leq 2.10^{-1}$ mbar move the selector valve to position 2.	Main unit Pirani gauge API 101 T
5. Slowly open the throttle valve (position 3). The triode gauge needle should stay in the green zone.	Main unit Electronic cabinet
6. Put the range selector to the lowest possible scale. The background signal may limit the minimal detectable leak which can be found (or automatic mode).	Electronic cabinet
7. Perform test.	
8. When the test is completed, close the throttle valve and move the selector valve to position 4. Break the vacuum at the inlet port.	Main unit

6.153 Testing leaks from 2.10-1 to 1 atm.cc/s

OPERATION	LOCATION
1. With the throttle valve closed, connect the piece to be tested to the inlet of the leak detector.	Main unit
2. Set the range selector to the 10.10-6 range.	Electronic cabinet
3. Move the selector valve to position 1. The mechanical pump will begin to gurgle and the inlet pressure will decrease.	Main unit

OPERATION	LOCATION
<p>the throttle valve, the triode gauge needle must stay in the green zone.</p> <p>5. Set the range selector to the lowest possible scale (or automatic mode).</p> <p>6. Perform the leak test quickly as there is nothing backing the turbo pump and the helium signal will increase continuously.</p> <p>7. When the test is finished, close the throttle valve and move the selector valve to position 4. Break the vacuum at the inlet port.</p>	<p>Electronic cabinet</p> <p>Main unit</p>

6.154 Testing leaks from 1 to 100 atm.cc/s

OPERATION	LOCATION
<p>1. With the throttle valve closed, connect the piece to be tested to the inlet of the leak detector.</p> <p>2. Move the leak selector valve to position 1. The mechanical pump will begin to gurgle and the inlet pressure will begin to decrease.</p> <p>3. Spray the test piece with helium while watching the inlet Pirani pressure gauge. If there is a leak, you should observe a fluctuation in the pressure needle.</p> <p>4. Move the selector valve to position 0 before removing the test piece.</p>	<p>Main unit</p> <p>Main unit</p> <p>Main unit Pirani gauge API 101 T</p> <p>Main unit</p>



6.155 Testing leaks with sniffing pistol

OPERATION	LOCATION
<p>1. Connect the sniffing pistol to the inlet of the leak detector as if it was a piece under test. Get the leak detector ready for test as in paragraph 6.14.</p> <p>2. Open the valve on the sniffing pistol so that pressure indicated by the triode gauge reads 1.10^{-4} mbar. It may be necessary to wait approximately 10 minutes for the pressure to stabilize because of the plastic tubing.</p> <p>3. Perform test by running probe around pressurized test piece.</p>	

6.15 Testing leaks with long distance sniffer

OPERATION	LOCATION
Set the selector valve to position 4 and see § 8.3.	

6.16 Shut down procedure

OPERATION	LOCATION
1. Set the range selector to the 10.10^{-6} range.	Electronic cabinet
2. Close the throttle valve.	Main unit 
3. Move the selector valve to position 0.	Main unit
4. Press the red power button to turn off the main power.	Main unit 

6.17 Shut-off

OPERATION	LOCATION
Put the range on 10.10 ⁻⁶ scale (or automatic mode).	Electronic cabinet
Shut the inlet valve.	Analyser
Set the four-position valve knob on position 0.	Analyser
Press the red button that will switch off the main supply.	

6.18 Inlet safety valve operation

The safety valve principle has been described in § 3.343.

While operating the leak detector, sudden air inrush may result in automatic valve shutting.

To re-open the valve, turn the knob clockwise all the way down. Switch the filament on and turn the valve knob counter-clockwise to open.

6.19 Remarks about the "High sensitivity" tests

The ASM 110 TCL leak detector enables to measure, at full speed, 2.10⁻¹¹ atm.cc/s leaks. However such a high sensitivity is not always necessary.

Generally, when the acceptance threshold will be 10⁻⁸ atm.cc/s, the user will work on the 10.10⁻⁹ or 3.10⁻⁸ range.

Remember that the calibration must be achieved with a leak greater than 10⁻⁸ atm.cc/s.

6.2 MAINTENANCE

6.21 Quick checking

To make sure of normal operating conditions, it is only necessary to check

- zero stability rapid variations must not exceed ± 6 on 10.10-10 sensitivity range.

- when comparing the value indicated on a calibrated leak with the leak meter reading, this latter should not be more than 30 % lower (after adjustment of the helium peak).

If one of the above conditions is not fulfilled, see § 6.4 - Trouble working.

6.22 Complete overhaul

After dismantling and cleaning all the parts of the analyser unit, a complete test will be made with the following operations :

- electrometer tubes balancing § 5.232
- connect a voltmeter with 10 M impedance on the green and red plugs in E 01 card. Adjust the tension at 8 V with R 102 potentiometer.
- electrometer current adjustment § 6.12
- filament protection verification § 5.32
- inlet valve test verification : No adjustment. The valve should worked for 10-1 mbar pressure at the detector inlet.
- amplifier zero stability test
- helium signal stability test.

6.3 PERIODICAL MAINTENANCE OPERATIONS

FREQUENCY (HOURS)	MAINTENANCE OPERATIONS
200	Check the oil level of forepump
1000	Check the analysis cell background noise at 1.10-4 mbar (less than 10-8 atm.cc/s).
2000	Drain the mechanical forepump oil.
4000	Complete cleaning of : - vacuum system - analysis cell

FREQUENCY (HOURS)	MAINTENANCE OPERATIONS
10000	Remove dust from fan and electronic cabinet Mechanical forepump complete overhauling.
20000	Replace the turbomolecular pump fan. Replace the seals and gaskets.

Note :

- Reference chapter 7 for maintenance instructions for the 5101 TMP.
- Reference 2004 manual for maintenance instructions for the mechanical pump, in the fourth part of the manual.

6.4 TROUBLE WORKING

If several detectors are used, it will be easier to locate any defect by substitution of interchangeable parts such as amplifier, pre-amplifier or connection cable.

6.41 Mechanical pump motor

TROUBLE	CORRECTION
Difficult on start-up	- normal if the temperature is lower than 10°C. - use a heater if necessary.

6.42 Inlet safety valve

TROUBLE	CORRECTION
The valve does not	- check if coil is energized : 5,5 V. DC between P 08.1

TROUBLE	CORRECTION
The pilot light ✓ does not light up.	<ul style="list-style-type: none"> - check if pilot light is energized : 5,5 V.DC. - check coil terminals P 08.3 / P 08.2. - check bulb

6.43 Pumping system

TROUBLE	CORRECTION
Pressure stays over 1.10^{-5} mbar few minutes after the starting.	<ul style="list-style-type: none"> - could be a leak in the vacuum circuit : <ul style="list-style-type: none"> . close the inlet valve . leak check the vacuum circuit with helium - check to see if TMP has reached operational speed (green light switched on analyser).

6.44 Amplifier zero setting

TROUBLE	CORRECTION
No possible adjustment.	<ul style="list-style-type: none"> - Perform the adjustment described in § 5.232. - If possible, use another pre-amplifier or another electronic cabinet.
The display swings suddenly to the left and sticks there for several minutes before returning to its normal position.	<ul style="list-style-type: none"> - Electrical parasits due to : <ul style="list-style-type: none"> . mains power . a wire broken in a cable or a plug
Zero is unstable on scale 10.10^{-10} (more than <u>+3</u> small divisions).	<ul style="list-style-type: none"> - Try to substitute a spare pre-amplifier, adjust polarities as indicated in § 5.232.

6.45 Analysis cell

TROUBLE	CORRECTION
The filament light does not light up.	<ul style="list-style-type: none"> - check the bulb and voltage at bulb contacts. - check the filament continuity circuits between J 06.1 and J 06.5. - check filament power supply (see electrical diagram).
On filament switch on, pressure rises and filament goes off.	<ul style="list-style-type: none"> - clean the analysis cell (§ 3.134.2).
No helium signal with calibrated leak on.	<ul style="list-style-type: none"> - make sure the inlet valve is opened and the filament has been switched on. - adjust "helium peak" potentiometer (electronic cabinet front panel). - check electronic current is 1 mA (1 V.) on J 5 and J 6 plus terminals. - make sure acceleration voltage between P 06.4 and P 06.6 is about 220V. - make sure the magnet is properly installed with "N" stamped pole facing the rear of the cabinet. - dismantle the analysis cell, check the cell cleanliness. Make sure the filament alignment is correct. - check the electrodes of the analysis cell are not shorted with ground. - there is probably a short-circuit between ground and ionization chamber if the filament light brightness varies when acceleration voltage is varied.
Lack of sensitivity	<ul style="list-style-type: none"> - dismantle the analysis cell. Check the filament cleanliness and its alignment. - change the electron collector - clean the analysis cell and its chamber.

TROUBLE	CORRECTION
<p>Large helium signal without calibrated leak at ultimate pressure (lower than 10^{-5} mbar).</p>	<ul style="list-style-type: none"> - has TMP reached operational speed ? - is mechanical pump rotating ? - is there any helium in the room ? - check level and cleanliness of mechanical pump oil. - shut the inlet valve. If signal goes off, clean the inlet valve. - if signal does not go off, clean the analysis cell.
<p>More than 50 % less on helium signal between 10^{-6} and 10^{-4} mbar.</p>	<ul style="list-style-type: none"> - clean the analysis cell and change the electron collector.
<p>Helium signal instabilities : peaks with periods of a few minutes.</p>	<ul style="list-style-type: none"> - clean the inlet valve. - do not use grease.

Troubles only for "new" electronic

TROUBLE	CORRECTION
<p>No pilot light lights up on the box.</p>	<ul style="list-style-type: none"> - check the fuse situated on the basic card. Change it if necessary. - check that mains input on the P 01 plug between the terminals 23 and 25. - check the presence of a continuous voltage of about 18 V at the CR 5 diode terminals, on the mother-board card. - if there is no voltage, change the mother-board card.
<p>The scale self-acting switching does not work.</p>	<ul style="list-style-type: none"> - replace the E 03 card.
<p>The exponent display is not correct.</p>	<ul style="list-style-type: none"> - check that the E 03 card switches are correctly positioned. - replace the E 03 switching card.

6.5 SPARE PARTS KIT

6.51 Maintenance kit for ASM 10 - ref. 67542

QUANTITE	DESCRIPTION	PART NUMBER
1	Mechanical pump oil charge	10990
2	Complete filament assembly	53146
5	Screws CM 2 L 4	83489
5	Washers Trepp diam. 6	84486
5	Electron collector	83485
1	Preamplifier	86393
1	Solenoid coil	57505
3	Pirani filament	57972
2	Alumina spacers	83467
1	PC board E 01 A 313836	67522
1	PC board E 02 A 313835	67521
1	Potentiometer R 103	37519
1	Potentiometer R 104	87554
1	Potentiometer R 105	87552
1	Potentiometer R 108	37512
1	Potentiometer R 109	37511
2	Diodes CR 13 - CR 14	87380
1	Transistor Q 15	87406
2	Fuses F 01 0,5 A	60519
1	Galvanometer M 01	55497
1	Switch S 02	60300
1	Transformer T 01	55499
3	Bulbs for lights DS 01, DS 02, DS 03	60041
1	Galvanometer M 02	55498
1	Seals kit	67541
2	fuses I A	83473

Maintenance kit specific for "new" electronic

	standard	3 mass option
Mother-board card	072 673	072 673
Scaling card E 03	072 671	072 671
Display card E 04	072 666	072 668
Fuse (220 V version)	083 472	083 473
Fuse (115 V version)	060 522	060 522

6.52 ASM 110 TCL specific parts

QUANTITY	DESCRIPTION	PART NUMBER
1	Spare part kit for TMP 5101	62698
1	Adjusted printed board for CFV 100	62760
1	Light BD 601 R	39900
1	Light BD 603 G	39901
1	Light BD 609 Y	39902
1	Self transformer (100-115 V.) (Option 100 V. 60 Hz)	67806
1	Fuse 0,3 A TD (200 V.)	60529
1	Fuse 0,6 A TD (100 - 115 V.)	60857

6.6. MAINTENANCE KIT

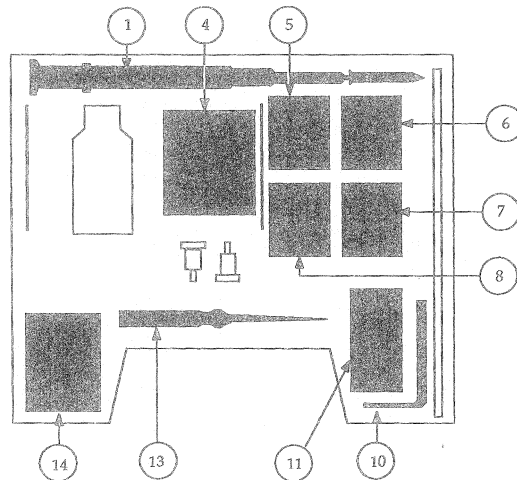

Rep.	Qty	Designation	P/N	Tension	Assembly
1	1	Syringe	056 993		TMP
4	1	Filament assembly	053 146		Cell
7	1	Tube	083 354		Electronique
7	3	Bulb	060 001		
8	1	Tube	083 854		
8	1	Electron collector	083 485		Cell
8	5	Screw	083 489		Cell
10	1	Ø 5 allen key	089 141		Cell
11	1	Rechange PII	057 972		Gauge PII
13	1	Screw driver	089 194		
14	1	Tube	031 375		
14	1	Gasket	053 147		Cell
14	1	Gasket	083 476		Cell
14	1	Lead gasket	083 478		Cell
14	1	D1TD 5 x 20 0,5 A fuse delayed	060 519	220 V	CFV 100
14	2	D1TD 5 x 20 1 A fuse delayed	083 473	220 V	Electronique
14	1	D1TD 5 x 20 1 A fuse delayed	083 473	115 V	CFV 100
14	2	D1TD 5 x 20 2 A fuse delayed	060 522	115 V	Electronique
14	2	D1TD 5 x 20 2 A fuse delayed	060 522		CFV 100
*	1	Mechanical pump oil charge	010 990		

* Supplementary supply

CHAPTER 7

TMP 5101

CONTENTS	
7.1. Description	1
7.2. Technicals specifications	2
7.3. Utilization	3
7.4. Maintenance and servicing	4

7.1 DESCRIPTION

The following equipment is standard :

- the turbomolecular 5101 pump itself
- the static frequency converter
- necessary electrical connectors, inside the leak detector.

7.1.1. 5101 TURBOMOLECULAR PUMP (see figure 16, 3rd part)

The Alcatel 5101 turbomolecular pump (TMP) is a one-hundred percent turbo multistage design. Its rotational speed is 27 000 rpm.

The heart of the pump is assembled at the end of a shaft that turns in two grease lubricated high-precision ball bearings, located in the forevacuum. The pumping elements are made of aluminium alloy.

The pump is powered by an electronic commutation motor, mounted between the two ball bearings. The rotor fits directly on the shaft, and the stator, mounted in the body of the pump, is cooled by a cooling coil located outside the pump, but inside the leak detector.

Inlet flange :

- Model 5101 : Pneurop NW 100 flange.
- Model 5101 UHV : UHV 6" OD ultra-vacuum flange or the "knife edge ultra vacuum type", for copper seal.

Outlet flange :

- Pneurop NW 25 nipple.

7.1.2. STATIC FREQUENCY CONVERTER

The electronic frequency converter is an adjusted printed circuit board, located on the bottom of the analyzer, near the roughing pump (see picture in leak detector manual). It supplies TMP motor and controls the speed up to 27 000 rpm.

General electrical schematic is provided at the end of this manual.

A number of safety devices built into TMP and converter monitor proper functioning of the unit.

- 1 green pilot light " = 27 000"
When it is "ON", it indicates that the converter is producing 450 Hz A.C. to drive the TMP motor.
- 1 yellow pilot light "< 27 000"
When it is "ON", it indicates that the TMP is :
 - in starting period
 - in overloading : for example, in a continuous use at a pressure up to 10^{-1} mbar.
- 1 red pilot
This light stays "OFF" as long as everything is operating normally. If a malfunction occurs, it lights "ON" and indicates :
 - that there is something wrong with the converter operation
 - that the temperature of the pump or its motor is too high.

The motor is not energized and the pump is not running.

7.2. TECHNICAL SPECIFICATIONS

7.2.1. PUMP

- Flowrate at inlet :
 - Nitrogen N_2 : 100 l/s
 - Helium He : 60 l/s
 - Hydrogen H_2 : 40 l/s
- Compression for :
 - Nitrogen N_2 : $8 \cdot 10^7$
 - Helium He : 2500
 - Hydrogen H_2 : 300
- Ultimate pressure with 2 stages roughing pump (RP) and metal seal at inlet $< 5 \cdot 10^{-9}$ mbar.
- Speed : 27 000 rpm.
- Startup : < 2 minutes.
- Ambient temperature : 0 to 35 °C.
- Weight : 3 kg.

7.2.2. ELECTRONIC CONVERTER

- Fuse at the rear panel from the analyzer
 - 500 mA for 200 V - 220 V - 240 V
 - 1 mA for 100 V - 115 V

- Maximum power draw : 75 VA.
- Output voltage : 42 V.
- Output frequency : 0 to 450 Hz.
- Ambient temperature : 0 to 50 °C.
- TMP cable : leight 0,25 m connected in P2 (inside leak detector).
- Weight : = 800 g.
- Dimension : 98 x 27 (height 50).

7.3. UTILIZATION

The leak detector electronic cabinet controls automatically the frequency converter : when the Pirani gauge indicates 10^{-2} mbar at TMP inlet, the motor starts and TMP runs.

The detection of rotation is materialised by three pilot lights, yellow, green and red, which indicate the TMP motor speed.

The different possibilities are listed bellow :

	TMP motor	Pilot lights			TMP speed
		yellow	green	red	
1. Before starting	0	0	0	0	0
2. Starting	1	1	0	0	< 27 000 rpm
3. Pump at full speed	1	0	1	0	= 27 000 rpm
4. Abnormal temperature of pump or converter **	0	0	0	1	0
5. Overloading	1	1	0	0	< 27 000 rpm
6. Pumping stop *	0	0	0	0	0

* Without air intake, the TMP is totally stopped after 20 minutes.

** When the TMP or converter temperature decrease, the cycles 2, 3 (or 5) will repeat until user remedies the incident.

7.4. MAINTENANCE AND SERVICING

7.4.1. FILLING WITH GREASE AND CHANGING GREASE

The quantity of grease necessary for TMP operation was added before the pump was first started at the factory and remains in the pump during shipment. The grease must be changed by the user, in some conditions following periods of time (see figure 1).

You must only use the Alcatel grease, contents in the syringe (4.5 g).

DURING GREASE CHANGE, PROCEED CAREFULLY WITH MAXIMUM CLEANNESS, LIKE THIS :

a. Ball bearing opposite the pumping unit (RP is stop).

(See figure 18, 3rd part)

1. Remove the part (11) with the 2 screws (E).
2. Remove the spring (D) and the spacer (10).
3. Insert the syringe to the ball bearing.
4. Remove the red spacer and inject progressively the grease (photo 7.2).

b. Ball bearing near the pumping unit (see figure 18, 3rd part)

1. Insert the syringe through the screw (8) to the end of the axle (3). The syringe must strike against the head of the screw (8). (See photo 7.3)
2. Remove the black spacer and inject progressively the grease. (See photo 7.3)
3. Remove the syringe.
4. Reassemble the spacer (10) and the spring (D).
5. Close with the part (11) and its o-ring and screw with (E).

c. Startup after "new lubrication"

Start the TMP to atmosphere pressure for 5 minutes. For this :

- Disconnect RP from TMP.
- Start detector and allow TMP run for 5 minutes.

- Reconnect RP to TMP.

To terminate, apply the cycles described by the following schedule :

Action on detector's circuit breaker	Waiting	Pilot lights
Start	30 s	yellow ON
Stop	2 mn 30 s	/
Start	30 s	yellow ON
Stop	2 mn 30 s	/
Start	1 mn	yellow or green ON
Stop	3 mn	/
Start	1 mn	yellow or green ON
Stop	3 mn	/
Start	1 mn 30 s	yellow or green ON
Stop	4 mn 30 s	/
Start	1 mn 30 s	yellow or green ON

Now, TMP is ready to be used.

7.4.2. REPLACEMENT OF BALL BEARINGS

The ball bearings can be replaced at the user's location.

The replacement of the bearings should be performed by the Maintenance Department ; in exceptional cases, keeping with Maintenance Department, it can however also be carried out by skilled staff of the customer. In this case, we supply instruction manual about ball bearings replacement and special Alcatel tools.

7.4.3. SPARE PARTS LIST

Seals kit P/N 062698

This kit contains all pump seals for complete disassembly.

Spring of lubrication : P/N 056993

Splinter shield :

The splinter shield is installed at the inlet of the TMP : It protects

Reference	Description	P/N
3	Electric motor	56958
4a - 4b	Ball bearings	76413
2a - 2b	O -ring	79068
6	O-ring	79067
13	O-ring	82047
24	Pump body Ø 100 Pneurop	56965
	OR pump body UHV ISO 6" OD	56787
25	O-ring	79247
26	Thermostat	56578
27	Jaeger male connector	60709
28	O-ring	79246

CHAPTER 8

OPTION

CONTENTS

8.1. Gross leak option	1
8.2. Other voltages	1
8.3. Long distance sniffer	2

8.1 GROSS LEAK OPTION

There are nine ranges in the standard ASM 110 TCL. It is possible to achieve measurements between 10^{-9} and 10^{-5} full scale.

Some users prefer a 10^{-8} / 10^{-4} range.

ASM 110 TCL detector can be equipped with such a range. The pre-amplifier inlet resistor whose normal value is 8.10×10^{11} , is 6.10^{10} in this case.

Other range can be supplied on request.

8.2 OTHER VOLTAGES

8.21 OPTION 115 V. 60 Hz

ASM 110 TCL detector can be supplied for 115 V, 60 Hz mains supply.

Differences between 115V, 60 Hz model and 220 V, 50 Hz model are as follow :

- Vane pump motor
- Timer
- Circuit breaker
- Fans
- T 01 special connection
- Electronic cabinet fuse

8.22 OPTION 100 V. 60 HZ

ASM 110 TCL detector can be supplied for 100 V, 60 Hz mains supply. It is necessary to add a 100/115 V, auto-transformer.

8.23 OPTION 240 V. 50 HZ

ASM 110 TCL detector can be supplied for 240 V, 50 Hz mains supply. It is necessary to add a 220/240 V, auto-transformer.

8.3 LONG DISTANCE SNIFFER OR L.D. SNIFFER (ref. 85801)

This device is intended to enable a sniffing operation to be carried out by means of a helium mass spectrometer on an object situated more than a few meters away from the detector.

8.31. Principle

The helium leak testing of any vessel by the sniffing method consist of :

- pressurizing helium into the object to be tested.
- sniffing any helium leak by means of a probe R.
- sending the flow of gas on to an analyser D which detects any tracer helium.

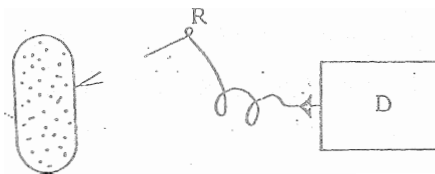

For distances under 2 meters the probe is connected directly to the detector D.

Figure 1

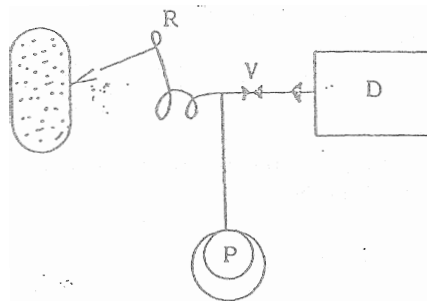

For distances over a few meters, an auxiliary pump must be used, which enables the tracer gas to be carried in viscous flow, in order to obtain the right transfer speed. The detector is then connected in parallel to the sniffing circuit by a valve or a diaphragm V.

This method is inconvenient because the user has to add a pumping device (membrane or vane pump) too bulky to be included in the housing of a portable detector, and necessitating a connection to a mains supply.

8.32. Description

Figure 3 gives a conventional diagram of the spectrometer detector :

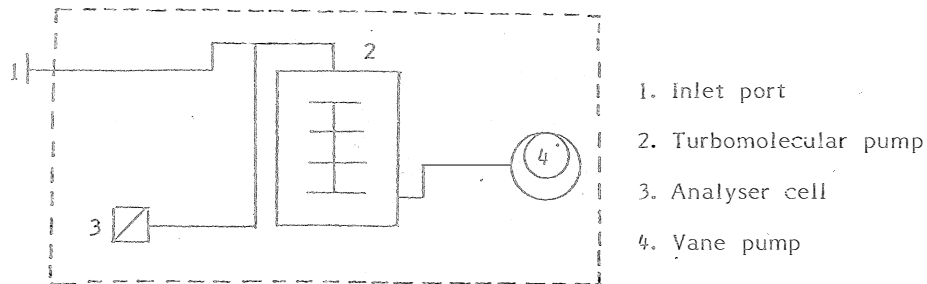
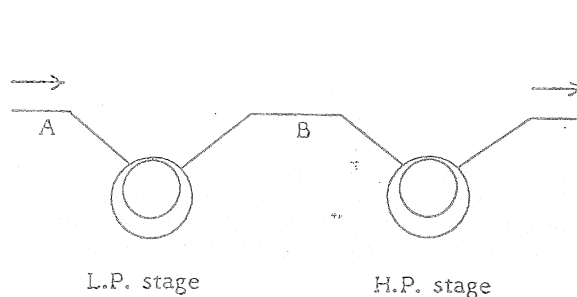

Figure 3

One could imagine connecting the sniffing probe to the inlet port of pump n°4. This unfortunately is impossible : to obtain an acceptable transfer speed, the pressure in the pump would have to reach too high a level, incompatible with the working of the turbomolecular pump.



However, if the design of pump 4 is examined more closely, it will be noted that this device generally comprises 2 pumping stages in series (figure 4).

So the idea was to install a deviation between the 2 stages at point B where pressure can build up without perturbing the TMP coupled at A.

This leads to diagram 5. The sniffer probe, made of a stainless steel capillary tube, is connected to the detector housing by means of a thin plastic tube and a pneumatic coupling K. This enables the probe to be easily connected or disconnected when the sniffing method is requisite.



CHAPTER 9

ASM 110 TL VERSION

CONTENTS	
9.1. Principle	1
9.2. Description	1
9.3. Performance	2
9.4. Direction for use	2

This version of leak detector will suit to users who just need sniffing operation (figures 14 and 15).

9.1 PRINCIPLE

The helium leak testing of any vessel by the sniffing method consists of :

- Pressurizing helium into the object to be tested
- Sniffing any helium leak by means of a probe
- Injecting the flow of gas on to an analyser which detects any tracer helium.

To work over a few meters from the detector, an auxiliary pump must be used, which enables the tracer gas to be carried in viscous flow, in order to obtain the right transfer speed.

The detector is then connected in parallel to the circuit by a diaphragm.

9.2 DESCRIPTION

The auxiliary pump for transfer in the sniffing tube is constituted by the first stage of the vane pump, so the pressure in the tube can be relatively high (viscous flow) without perturbing the turbomolecular pump which is connected at the second stage of the vane pump.

The probe is a metallic type pencil, connected by a plastic tube to a pneumatic coupling fixed on the analyser's front plate.

The gas flow through the probe across a sampling device (porous membrane) and is then evacuated by the high pressure stage of the vane pump.

An electromagnetic valve closes automatically in the event of a mains supply failure, in order to avoid an air inrush on the TMP when vane pump comes to a stop.

The detector is constituted by :

- 1 vane pump
- 1 turbomolecular pump
- 1 cell

there is no throttle valve.

9.3 PERFORMANCE

Detection of leaks ranging about 1.10^{-6} std.cc/s.

Transfer speed 5 m/s.

Pressure in analysis cell : 2.10^{-5} mbar.

9.4 DIRECTIONS FOR USE

All that is necessary is to connect the quick pneumatic coupling and check that this operation increases the triode pressure to 2.10^{-5} mbar.

The probe is fitted a filter easily replaced when the pressure drops below 2.10^{-5} mbar.