

# ASM 10

## HELIUM LEAK DETECTOR

CHAPTER 1	<b>General</b>	
	1.1 - General specifications	1
	1.2 - Symbols	2
	1.3 - Functional specification	3
	1.4 - Layout of the technical manual	4
CHAPTER 2	<b>Analyser block</b>	
	2.1 - Analysis cell	5
	2.11 - Operating principle	7
	2.12 - Construction	8
	2.13 - Maintenance	10
	2.2 - High vacuum pumping unit	15
	2.21 - Vacuum block	17
	2.22 - Forepump and lines	20
	2.23 - Pirani gauge	21
	2.3 - Roughing circuit	23
	2.31 - Description	24
	2.32 - Mechanical pump	25
	2.33 - Inlet valve	26
CHAPTER 3	<b>General electric circuit</b>	
	3.1 - Analyser	27
	3.2 - Safety inlet valve	27
CHAPTER 4	<b>Electronic cabinet</b>	
	4.1 - Description	29
	4.2 - Operation and adjustments	30
CHAPTER 5	<b>Operating instructions</b>	
	5.1 - Use of the detector	35
	5.2 - Maintenance	41
	5.3 - Periodical maintenance operations	42
	5.4 - Trouble checking	43
	5.5 - Spare parts	46
	5.6 - Accessories	47
CHAPTER 6	<b>Options</b>	
	6.1 - Mass. 2. 3. 4,	49
	6.2 - Gross leak	51
	6.3 - 115 V. - 60 Hz.	52
	6.4 - Long distance sniffer	53
CHAPTER 7	<b>Figures and drawings</b>	

## GENERAL SPECIFICATION

ALCATEL ASM 10 is a complete, portable leak station : it includes a gas analyser and a roughing system.



It comes in two separated units (figure 2) :

GAS ANALYSER		ELECTRONIC CABINET
Width	380 mm	230 mm
Length	530 mm	250 mm
Height	470 mm	150 mm
Weight	53 Kg	5 Kg







- . Power supply : 220 V. - 50 Hz. single phase  
115 V. - 60 Hz. single phase (option)  
750 W.
- . Daily consumption of liquid nitrogen : 2 liters
- . Liquid nitrogen life : 16 hours
- . Oil capacity    forepump : 500 cc  
                  diffusion pump : 60 cc

SYMBOLS

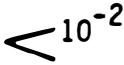
GAS ANALYSER (figure 2)

Roughing valve :		Open
		Closed
By-pass valve : position 1 :		Roughing
position 2 :		Detection
medium :		Closed

ELECTRONIC CABINET (figure 5)

Green light 	Analysis cell pressure is  $10^{-2}$ mbar
Green light 	Filament on
Green light 	Throttle valve is open
	Sensibility adjustment
	Audio signal volume control
	Audio signal threshold
" 0 "	Zero adjustment knob
50 mV	Recording output 50 mV
He	Helium signal adjustment

## OPERATION SPECIFICATION OF THE ASM 10 LEAK DETECTOR

. Maximum operating pressure of the analysis cell	$10^{-4}$ mbar
. Pumping speed for air	
. In front of the analysis cell at $1.10^{-4}$ mbar	3 l/s air
. At the inlet valve	3.5 l/s air
. Intrinsic sensitivity of the analysis cell	3.5 A/mbar
. Variation of sensitivity as a function of pressure between $10^{-6}$ and $10^{-4}$ mbar	+ 20 % max.
x . Smallest signal detectable at an air pumping speed of 3.5 l/s	$2.10^{-11}$ atm.cm <sup>3</sup> /s He
x . Smallest signal detectable at an air pumping speed of 1.1 l/s	$1.10^{-12}$ atm.cm <sup>3</sup> /s He
. Direct reading range	$2.10^{-11}$ to $1.10^{-5}$ atm.cm <sup>3</sup> /s He
. Response time	
. Scale $10.10^{-10}$	1.5 s
. Scale $3.10^{-9}$	1 s
. Scale $10.10^{-9}$ $10.10^{-6}$	0.5 s
. Filament protection (triode)	off at $2.10^{-4}$ mbar
. Diffusion pump protection (Pirani gauge)	Closing of the safety inlet valve at $5.10^{-2}$ mbar
. Audio signal	Adjustable on the whole range
. Air roughing pumping speed at the inlet port	1 l/s

NOTE :

1 mbar	=	0.75 Torr
1 mbar	=	100 Pascals
1 Torr	=	1 mm Hg

- x The leak detector is calibrated for helium.  
To convert into air leak, divide the figures by 2.6

## LAYOUT OF TECHNICAL MANUAL

ASM 10 detector is made of two parts :

- A "analyser block" which contains the main part of the equipment : the analysis cell with its high vacuum pumping station, the general electric circuits, the roughing station.
- An "electronic cabinet" with the control and the signal-lights

In this document, we shall study :

- The "analyser block" chapter 2
- The general electric circuits chapter 3
- The "electronic cabinet" chapter 4

Moreover, we shall find :

- The operating instructions chapter 5
- The options chapter 6
- The figures and drawings chapter 7

THE USER SHOULD READ AT LEAST CHAPTER 5 (RED INDEX)

2 - 1

ANALYSIS CELL

CONTENTS	
2.11 -	OPERATING PRINCIPLE
2.12 -	CONSTRUCTION
2.13 -	MAINTENANCE

## 2.11 - OPERATING PRINCIPLE (figure 7)

Detection of helium is made by means of a mass spectrometer analysis cell tuned for the mass of helium ( $m/e = 4$ ), or another light mass ( $m/e = 2$  or  $3$ )

$m/e$  : atomic weight of the particle / number of electrons lost in ionization

The principle of magnetic deflection spectrometers is as follows.

The neutral molecules of the gas to be analysed pass into an ionization chamber (or ion source) where they are bombarded by an electron beam emitted by a heated tungsten filament. A considerable part of the molecules are converted into ions. These ionized particles are then accelerated by an electric field.

The analysis tube is subjected to a magnetic field which bends the ion paths along different radii, according to the mass of ions (or more precisely, according to the  $m/e$  ratio). Thus, the ion beam which contained ions of different mass is separated into several beams, each containing only ions of the same  $m/e$  ratio. The helium ions ( $m/e = 4$ ) are separated from the lighter ions ( $H^+$  and  $H_2^+$  of lesser radius) and heavier ions ( $N^+$  and  $O^+$  of greater radius).

With a constant magnetic field (permanent magnet), the accelerating field is adjusted so that the helium ions ( $m/e = 4$ ) follow a specific path (passage through diaphragms) and strike the target placed at the entrance of a direct current amplifier.

The helium ion current is proportional to the partial helium pressure in the installation and its measurement makes it possible to determine the value of the flow of the leak detected.

The total pressure in the analysis must be less than  $2 \times 10^{-4}$  mbar so that the electron and ion paths are not disturbed by residual molecules. But the risk of damage to the heated filament only begins at about  $10^{-3}$  mbar.

Note 1 : To obtain proper separation of the helium ions from the "noise" due to scattered ions, an electrode placed in front of the target eliminates the secondary ions of low energy. This electrode is called "repeller".

Note 2 : an auxiliary electrode in front of a plate is located at the top of the tube. This electrode collects ions having a greater mass than the helium ions. This electrode thus permits measurement of the total pressure in the analyser without using a Penning-gauge. (Indeed, it is not suitable to measure signals of very low value ( $1 \times 10^{-11}$  atm.cm<sup>3</sup>/s) by retaining a Penning-gauge which is a helium noise source). This electrode acts as the plate of a triode gauge, hence the name "triode electrode".

When measuring signals of very low value, it is not advisable to use a Penning-gauge which is a source of helium noise.

The analysis cell has been carefully constructed in order to obtain a high degree of reproducibility of characteristics and good stability:

- Metal parts of stainless steel
- Filament holder of machined alumina
- Built-in pre-amplifier.

The analysis cell assembly (see figures 8 and 9) mainly consists of :

- a) A vacuum or deflection chamber
- b) A lens holder flange
- c) A permanent magnet
- d) A pre-amplifier

a) The vacuum chamber of the analysis cell is made of a light alloy. It has a rectangular opening into which fits the entire set of electrodes attached to the "lens holder flange".

b) The lens holder flange serves as a support for all the electrodes and electric feedthroughs of the cell. It includes :

- A power feedthrough socket mounted with a metal seal,
- A pre-amplifier mounted with a metal seal,
- A massive block for the target mounting and shielding,
- An ion source which consists of two parts :
  - . a filament holder
  - . a ionization chamber with a stainless steel sheet electron collector and a massive ion emitter.

The filament holder mechanically positions the tungsten filament with respect to the ionization chamber.

The electron collector and the filament are constructed and arranged in such a way that the temperature of the electron collector stabilizes at 400° C by electron bombardment and filament radiation. The cell is therefore made impervious to contamination due to impurities of the articles tested, without having to use a special heating system.



c) The permanent magnet which creates the deflective magnetic field. It consists of :

- The permanent magnet itself
- 2 Machined pole parts which are attached to the magnet by araldite. These parts should never be detached from the magnet.

One pole is marked N.

NOTE : following disassembly of the unit, care must be taken to properly reposition the magnet (pole part N in the back).

d) The pre-amplifier (figure 10), is mounted on a 12-pin feedthrough socket and consists of :

- 2 Electrometer tubes
- 1 Resistor ( $6.10^{11}$  atm.
- 1 Target.

These parts form a rigid assembly which cannot be disassembled and should not be touched with the fingers.

## 2.13 - MAINTENANCE

There are three normal maintenance operations to be carried out on the analysis cell :

- Replacement of the filament
- Cleaning of the ion source cell
- Cleaning of the entire analysis cell.

### 2.131 - Replacement of the filament

Replacement of the filament requires only very partial disassembly of the analysis cell. Replacement is carried out in the following manner :

- Turn leak detector off. Allow 10 minutes for the diffusion pump to cool down.
- Pull out the nitrogen trap finger (§ 2.2121 trap).
- Disconnect the two Jaeger plugs of the analysis cell.
- Unscrew the six screws (socket wrench).
- Remove the lens holder flange (the gasket cannot be re-used) and place it on a very clean sheet of white paper.
- Loosen the 2 set screws of the U-links of the filament clamps and their connections.
- Unscrew the filament holder screw and remove the filament.

To install a new filament, the above operations are carried out in the reverse order.

When these operations are being carried out, care should be taken not to touch the internal parts of the analysis cell with fingers.

### REMARKS :

- 1 - Visually check to make sure the filament is correctly placed in front of the slot of the ion source. If necessary, change the position of the collector by slightly loosening its two fixing screws.
- 2° - The tungsten filament, which is hardened by a special heat treatment, is fragile. It should never be touched. Handle the filament holder with pliers.
- 3 - To replace the metal gasket, use lead wire 0,8 mm in diameter and clean it with alcohol. Form a rectangular loop with the wire by overlapping the two ends at one of the corners :
  - carefully place the gasket horizontally on the vacuum chamber.
  - carefully lower the lens holder flange vertically into place.
  - gradually tighten the screw, a little at a time, do not completely crush the spring washers.

NOTE : The use of pure lead is not recommended. Use commercially available fuse wire, a shiny lead/Antimony, which makes it easier to obtain airtightness.

Tools :

- A socket wrench for size 5 mm allen screws
- A 2.5 mm screwdriver
- A pair of Precelle pliers

2.132 - Cleaning of the ion source supply only

Cleaning is only carried out when there is a loss of sensitivity. The lens holder flange is removed as indicated in § 2.131. After having removed the filament, the electron collector is removed. The collector is cleaned as indicated in § 2.133 below. In particular, the inlet slot and the electron impact surface should be cleaned. Preferably, this collector should be replaced by our standard replacement part available at a low price.

Tools :

The same as in § 2.131.

2.133 - Cleaning of the entire analysis cell

Cleaning of the entire analysis cell is only required under exceptional conditions (flash, generalized contamination resulting in insulating deposition film). This operation should be carried out with the greatest care (cleanliness, cleaning, degassing, etc...).

The user must :

- Carry out the operation in a very clean room (clean room or laboratory or office) in which there is a working surface covered with white paper.
- Not touch the electrodes with his fingers during the disassembly.

Disassembly :

- 1° Begin this operation as was indicated for replacement of the filament, then :
- 2° Disconnect the triode electrode  
" " repeller electrode
- 3° Disconnect the other parts.

### Cleaning :

All the parts are cleaned in a bath consisting of :

- 50 % ethyl alcohol
- 50 % ethyl acetate, then rubbed and dried with paper.

If necessary, use abrasive cloth to remove the insulating the metal pieces of the analysis cell and the vacuum chamber.

### Reassembly :

Reassembly is carried out by performing the above operations in the reverse order, without touching the parts with the fingers. Reinstall the alumina spacers and proper center them.

### Tools for disassembly of the analysis cell

- 1 pair of Precelle pliers
- 1 x 5 mm allen key
- 1 x 4 mm screwdriver
- 1 x 2.5 mm screwdriver
- 2 aluminium gaskets
- 0.8 mm diameter lead wire

NOTE 1 : We have already seen that the electrodes can normally be cleaned and the filament replaced without removing the vacuum chamber. Should this however prove to be necessary, the operation will be carried out in the following manner :

- Disconnect the two Jaeger plugs of the cell.
- Remove the clamp between the analysis cell and the nitrogen trap.
- Pull out the analysis cell assembly.

### Reassembly :

- The centering ring with indium wire can be re-used several times.
- Fix the analysis cell with the clamp.

NOTE 2 : After having opened the analysis cell, make sure the gaskets are airtight by using the detector itself.

### 2.134 - Troubles

#### 2.1341 - Filament breaking

This trouble is easy to detect. By means of a calibrated leak, it can be found that the detector no longer generates a signal and that the "filament" light is out.

By checking the Jaeger plug with an ohmmeter, an open circuit will be measured (broken filament) between contacts 1 and 5.

#### Causes

In general, filaments burn out due to abnormal wear resulting from successive air intrushes. It will then be noted that there is a deposit of blue or yellow powder on the electron collector due to evaporation of the tungsten.

#### Corrective measures

The filament must be replaced (see § 2.131). If the filament has produced a flash, the ion source must be cleaned before a new filament is installed.

#### 2.1342 - Contamination of the analysis cell

There are two indications of contamination :

- 1) Due to outgassing, the filament goes off automatically, when being switched
- 2) A loss of sensitivity (ratio 2 or 3)

#### Corrective measures

The analysis cell is cleaned according to the procedure described in § 2.132 or 2.133.

NOTE : Loss of sensitivity can also be caused by deformation of the filament. It is possible to recenter the filament in front of the electron collector, thus avoiding having to replace the filament.

## HIGH VACUUM PUMPING UNIT

CONTENTS	
2.21	HIGH VACUUM PUMPS
2.22	FOREPUMP AND FORELINE
2.23	PIRANI GAUGE

The high vacuum unit consists of :

1) Two high vacuum pumps

- One nitrogen liquid trap
- One air cooled diffusion pump

2) One mechanical forepump used :

- As backing pump for the diffusion pump
- As roughing system, through the by-pass valve, to evacuate small articles on test.

3) One Pirani gauge head.

## 2.21 - HIGH VACUUM PUMPS

### 2.211 - Operating principle and construction

The high vacuum (  $< 10^{-4}$  mbar) is obtained by two different pumps

- A liquid nitrogen trap working as a cryogenic pump.
- An oil diffusion pump.

1 - The liquid nitrogen trap is a stainless steel cylinder body which is the basement of :

- The trap finger
- The analysis cell
- The Pirani gauge
- The inlet valve
- The liquid nitrogen trap is both a trap for oil vapour and a cryogenic pump.

2 - The standard diffusion pump is fixed on the liquid nitrogen trap with a set of clamps (270 watts - octoil)

### 2.212 - Maintenance

The normal maintenance operations are limited to :

- Disassembly and cleaning of the trap finger
- Replacement of the diffusion pump heater
- Complete cleaning of the high vacuum pump.

#### 2.2121 - Disassembly of the nitrogen trap

- a) Turn the leak detector off. Allow 10 minutes for the diffusion pump cool down.
- b) Remove the trap finger : as the trap is under vacuum it is difficult to remove it by hand : use the two extraction screws supplied with the equipment.



Trap cleaning :

Clean the trap with alcohol and then dry it, preferably with paper or a lint free cloth.

Trap reassembly :

Remove the extraction screws. Re-install the trap finger.

Maintenance :

It is recommended to clean the trap every day.

2.2122 - Replacement of the diffusion pump heater.

- Disconnect the connector
- Unscrew the screw under the boiler
- Remove the cover
- Remove the heater

Tool :

Size 17 wrench.

2.2123 - Disassembly and cleaning of the diffusion pump.

Proceed as indicated in § 2.2121 and 2.2122.

- Pull out the plastic foreline tube of the diffusion pump (o-ring nipple).
- Remove the fan connector and ground wire.
- Unscrew the three screws which hold the diffusion pump to the trap (size 17 wrench).
- Remove the diffusion pump.
- Dismantle the fan support housing.
- Remove the jet assembly.
- To dismantle the jet assembly, remove the pin which holds the spring under tension.

Cleaning :

Clean any brown spots on the jets using a cloth soaked with alcohol or, if necessary, a fine abrasive cloth.  
To degrease the pump body and the jets, use trichloroethylene. Dry the parts.

Reassembly :

Carry out the operation in the reserve order.

Use the hook delivered with the equipment to stretch the spring holding the jets together.

Tool :

- Size 17 wrench.
- One 6 mm. screwdriver.
- Size 7 wrench.
- Special hook (§ 5.6)

2.2124 - Regular maintenance

After operating for a day, the trap should be cleaned as in § 2.2121. The frequency of this cleaning depends on the working conditions. A weekly cleaning may be sufficient..

2.2125 Possible trouble

When the diffusion pump is hot, if there is an accidental air inrush causing the pressure to rise to a very high level (several times 10 mbar) the oil oxidized and the diffusion pump does not work properly.

Oil oxidation may result in a low vacuum or in helium signal instability. Dark deposition may also be found on the jets.

Corrective action :

Carry out the operations indicated in § 2.2123.

## 2.22 - FOREPUMP AND FORELINES

### 2.221 - Operating principle and construction

For correct operation, a diffusion pump requires a backing pressure  $10^{-1}$  mbar. This function is ensured by a two-stage vane pump, mode 1 2004 A.

### 2.222 - Maintenance

#### Dismantling :

- Remove the leak detector cover.
- Remove the plastic tube of the diffusion pump.
- Remove the plastic tube of the foreline.
- Remove the ball valve.
- Disconnect the motor.
- Unscrew and remove the four pump fixing screws (under the frame).

#### Regular maintenance :

The mechanical pump oil level should be checked once a month.

The pump oil should be changed after every 2 000 hours of operation.

For specific maintenance of the mechanical pump model 2004 A, see maintenance and operating instruction manual.

The lines should be cleaned after every 4 000 hours of operations.

## 2.23 - PIRANI GAUGE

### 2.231 - Operating principle

The Pirani gauge is a thermic manometer : the temperature of a wire heated by an electric current depends on the pressure. The pressure measurement is carried out by measuring the resistance of the metallic wire (hence its temperature and the pressure).

The Pirani gauge has 3 functions :

- 1 - It shows that the pressure in the analyser is lower than  $5.10^{-2}$  mbar, by means of a green light " $< 10^{-2}$ " located on the electronic cabinet.
- 2 - It protects the analyser against a sudden pressure rise by closing the inlet valve (above  $5.10^{-2}$  mbar).
- 3 - It prevents the filament from being energized if the pressure exceeds  $5.10^{-2}$  mbar.

NOTE : The leak detector filament has its own protection device controlled by the triode electrode current.

### 2.232 - Construction

The Pirani filament is located in a glass tube mounted on a stainless steel flange.

### 2.233 - Maintenance

The Pirani gauge is cleaned with an alcohol / acetone solution after every 4 000 hours of operation.

### Disassembly and cleaning of the gauge head :

This operation must be carried out when the equipment is not operating. The gauge head is connected to the trap by a quick disconnect clamp with Buna o-ring :

- Disconnect the gauge power cord.
- Remove the gauge.
- Rinse the gauge head with an alcohol / acetone solution.  
The filament is replaceable (part number A 433 731).

2 - 3

## ROUGHING

CONTENTS	
2.31 -	DESCRIPTION
2.32 -	MECHANICAL PUMP - INLET LINES
2.33 -	INLET VALVE

## 2.31 - DESCRIPTION

This unit is used to rough the inlet valve and the inlet line at a pressure of  $10^{-3}$  mbar.

The roughing unit consists of two major parts :

- One vane pump model 2004 A (4 m<sup>3</sup>/h) and its connection to the inlet valve.
- An electromagnetic safety valve.

## 2.32 - MECHANICAL PUMP AND CONNECTION TO THE INLET VALVE

The mechanical pump model 2004 A is described in § 2.22.

This pump is connected to the inlet valve, by means of a ball valve, when the control knob is on position 1.

This pump is used to evacuate the inlet valve or pieces whose volumes do not exceed a few liters. For more important volumes, it is better to use an auxiliary roughing pump.

## 2.33 - INLET VALVE

### 2.331 - Introduction

This bellows-type valve protects the analyser from accidental air inrush. It also allows to work by throttling.

### 2.332 - Description

This valve is represented in figure 11.

### 2.333 - Operation of the safety device.

This is not a conventional electromagnetic valve. It opens manually and closes automatically. Its driving shaft is divided in two parts. The first one carries the electromagnetic coil. The other, a disk which closes the magnetic circuit.

The power to the coil is controlled by the Pirani gauge.

The pressure must be  $< 5 \cdot 10^{-2}$  mbar for the coil to be energized. To open the valve, the operator must first turn the valve control knob clockwise (which will bring the 2 disks into contact ; then he must turn the knob counter-clockwise).

### 2.334 - Maintenance

There is no special maintenance operation to be performed. The valve is disassembled and cleaned whenever general maintenance is carried out on the equipment.

In particular, maintenance will be required if the pressure in the analyser is higher than  $5 \cdot 10^{-5}$  mbar (with the detector inlet blanked off). Such maintenance will only be needed after 4000 or even 10 000 hours of operation, if the detector operates on clean articles.



## ANALYSER

### 3.1 - ANALYSER (figure 12 : electrical diagram)

The power supply controls are located in the electronic cabinet.

The on-off switch, with circuit breakers, is located on the front panel. It controls and protects the whole equipment (8 Amperes).

There is also a time counter.

A blower cools the diffusion pump. It will be cleaned every 2 000 hours and replaced after 20 000 hours.

### 3.2 - SAFETY INLET VALVE (figure 12 : electrical diagram).

- Rating : 7 volts - DC

- Voltage between P08. 1 and P08. 2 = 1.2 V.

A micro-switch in the valve monitors the valve opening.



The ASM 10 electronic circuits are located in a portable cabinet connected to the vacuum unit by means of a cable.

This arrangement has several advantages :

- Easy to carry.
- The solid state electronic cabinet temperature is not affected by the vacuum pumps heat.
- The portable control cabinet allows the operator to read both the total pressure and the helium partial pressure.

#### 4.1 - DESCRIPTION (fig. 5)

On the cabinet front panel are located :

- The leak meter (left hand side).
- The total pressure gauge meter (right hand side)
- The range selector and the sensitivity adjustment potentiometer (in the middle).
- 3 pilot lights (green) with the following engravings :
  - .   $10^{-2}$  indicates that the pressure in the analyser is below  $10^{-2}$  mbar.
  - .  indicates the filament is on.
  - . -  - indicates the inlet valve is open.
- The helium peak adjustment potentiometer (bottom right).
- The two controls of the audio signal (bottom right).
  - . Volume.
  - . Alarm threshold adjustment potentiometer.
- The zero adjustment potentiometer knob and the two recorder output sockets (bottom left). Green socket is ground.

At the rear of the cabinet are located :

- The cabinet to vacuum unit connection cable socket.
- The protection fuse.
- A socket for connection to a fast test station (DGC) or to a remote meter

## 4.2 - OPERATION AND ADJUSTMENT

The electric diagram of the electronic cabinet is shown in figure (drawing 6668-3).

Three different functions are to be distinguished :

- Pirani circuit :
  - . Board E02 FM 67 516 rear of the cabinet
- Filament and triode power supply :
  - . Board E02 FM 67 516 rear of the cabinet
  - . Heat sink for the power transistor rear of the cabinet
- Amplifier circuits :
  - . Board E01 FM 67 517 front of the cabinet

### 4.21 - Pirani circuits

They protect the analyser against pressure-rise. When the pressure, read by the Pirani gauge exceeds  $5.10^{-2}$  mbar, the safety valve power supply is switched off, and cell filament cannot be heated.

#### 4.211 - Pirani gauge operating principle

The temperature of a heated filament varies as a function of its exchanges with the ambient medium. The Pirani filament temperature is measured by its electric resistance.

#### 4.212 - Construction

The filament is connected to the cabinet terminals J01-20 and J01-21. It is inserted in a measuring bridge R57 - R 58 - R 59 (15 V. DC).

The diagonal signal is amplified by a Q18 and Q 12.

The relay K02 is open at atmospheric pressure and closes when the pressure reaches  $5.10^{-2}$  mbar. K02 relay allows :

- The filament to be switched on (contact 5.7)
- The safety valve coil to be energized (contact 8.10)

#### 4.213 - Adjustment

There is no adjustment required. The safety relay works when the pressure is lower than or equal to  $10^{-1}$  mbar at the detector inlet.

#### 4.22 - Triode power supply

The power supply delivers the different voltages needed for the two functions :

- Analysing function : measurement of the helium partial pressure.
- Vacuum measurement function : measurement of the total pressure, based on the principle of a triode vacuum gauge.

#### 4.221 - Construction

##### a - Analysis cell power supply

The filament is connected to terminals J01.19 and J01.22 in the electronic cabinet.

The heating power is delivered by the two 10 V. windings of transformer T01 through ballast transistor Q15 wired in series with the filament. When pressure conditions are satisfactory, the relay K01 turns on (contact 8.10). Filament is energized and pilot light DS 103 (mounted in parallel on Q15) lights up.

The heating power is controlled so as to maintain a constant electronic emission in the filament. For this, only a part of the diode filament - electron collector electronic current passes through the base emitter junction of Q03.

Potentiometer R 109 controls the electronic current adjustment. The electronic current can be measured at the resistor R81 terminals linked to red and green sockets on the printed board (1 K  $\Omega$  ).

Transistors Q03 - Q14 and Q13 amplify the control current and drive the ballast transistor.

The analyser power supply delivers also the polarization voltage to the different electrodes. Diodes CR 32 - CR 33 and CR 34 constitute a reference voltage chain :

- 120 V. fixed voltage between R 68 + R 69 terminals : polarization of the "filament electron-collector" diode.
- 200 V. adjustable acceleration voltage (adjustable through potentiometer R 108). To be measured between ground and CR32 - R72. Auxiliary terminals 38 and 41 on the printed board allow different adjustments of the acceleration voltage for masses 2, 3 and 4.
- Polarization voltage of the repeller electrode. The repeller electrode voltage is about 150 V. to the ground (terminal 37 on the printed board). This repeller prevents the scattered ions from penetrating into the ion collector.

b - Total pressure measurement :

The ionic current collected by the triode electrode is amplified by Q17 and measured by galvanometer M02. In addition, this output signal is applied to Q10 -Q11 amplifier which controls the filament on-off relay K01. Relay K01 is set on when the operator actuates lever  (S02). It goes off :

- . If pressure rises above  $5.10^{-4}$  mbar.
- . If the user pushes on the lever  S02.

#### 4.222 - Adjustments

At the factory :

Triode Q17 amplifier zero is adjusted through R 106 on printed board E02.

In the field :

Acceleration voltage adjustment through R 108 (Helium) and electronic current adjustment through R 109 (see 5.12, 6 and 7). 

There is no adjustment of the triode vacuum gauge : the filament safety threshold is set at a pressure of  $5.10^{-4}$  to  $10^{-3}$  mbar at the detector inlet port.

## 4.23 - Amplifier circuits

These circuits provide amplification, ionic current measurement, "leak" signal indication.

### 4.231 - Construction

We are going to study :

- The power supply circuits
- The current amplifier
- The audio signal device

#### a - Power supply

Transformer T01 can be connected either on 220 VAC or on 115 VAC. It delivers 4 different output voltages :

- A stabilized voltage of - 100 V. for the output stage of the amplifier.
- A regulated voltage of + 15 V. (integrated circuit Q19) for :
  - . The electrometer tubes of the amplifier Q16
  - . The triode vacuum gauge
  - . The Pirani vacuum gauge
- A regulated voltage of - 15 V. (integrated circuit Q20) for :
  - . The amplifier Q16
  - . The triode vacuum gauge
  - . The Pirani vacuum gauge
- Stabilized voltages of + 8 V., + 5.6 V., - 5.6 V. for the audio signal device.

#### b - Amplifier

The first amplification stage consists of two electrometer tubes under vacuum located in the analyser cell. This location is necessary as the measured currents are very low ( $2 \cdot 10^{-16}$  A) and the impedances are very high ( $6 \cdot 10^{11} \Omega$ ). One of the electrometer tubes is used as reference and provides the highest zero stability. The grid of the other one is connected to the target.

Polarization is determined by the voltage created in R 346 by the ionic current.

The whole can be balanced by adjusting R 101 and R 102 potentiometers.

The electrometer tube plates are connected to the two terminal inputs of the amplifier Q 16.

The output signal of Q16 amplifier is amplified in Q01 and Q04 and then delivered to galvanometer M01 through a resistor chain attenuator R41 to R46.

The output signal is injected by means of a feedback loop into resistor R 346 so as to stabilize the amplifier.

The zero of the amplifier can be modified from the front panel by turning "0" potentiometer (R 103) in order to cancel any parasite helium signal.

A remote leak meter, on option, can be connected in parallel with Q04 output through R31. In this case, the range selector S01 must be set on  $3.10^{-7}$  scale.

A recorder can be plugged in J02 and J03. The recorder must be grounded. It is connected in parallel with resistor R 17 (499  $\Omega$ ), its internal resistance must therefore exceed 50 000  $\Omega$  and its sensitivity must be 50 mV. for full scale deviation.

#### c -Audio signal

Q04 output drives the threshold amplifier Q05 - S06. The signal transmission threshold is adjusted by R 104. The amplified signal is sent to an oscillator whose frequency is related to the amplitude of the signal which controls it. In this way, the frequency of the audio signal varies with the intensity of the leak signal. An amplifier Q02, Q09 amplifies the oscillator signal. R 105 is used to adjust the volume.

### 4.232 - Adjustments

#### a -Amplifier

L 101 anode voltage is adjusted at 8 V. by R 102 (E01 printed board left).

Set zero of the amplifier with R 101, "0" potentiometer being palced two turns from full rotation.

#### b -Audio signal

Threshold adjustment by R 103 (see 5.13).

4.24 -

At the back of the ASM electronic unit the following information is available about the 12 pin socket,

- 1 - TRIODE PRESSURE
- 2 - FILAMENT
- 3 - FILAMENT
- 4 - THROTTLE VALVE
- 5 - THROTTLE VALVE
- 6 - AUDIO SIGNAL
- 7 - SIGNAL AMPLIFIER  
REMOTE METER
- 8 - MASS
- 9 - THRESHOLD  $10^{-2}$
- 10 - THRESHOLD  $10^{-2}$
- 11 - COIL POWER-SUPPLY OF THE SAMPLING-VALVE



## 5.1 - DETECTOR OPERATION

OPERATION	LOCATION
<b>5.11-START - UP</b>	
1 - Check the voltage before plugging in (220 V. 50 Hz. or 115 V. 60 Hz.)	Electronic cabinet (rear) Analyser (rear)
2 - Plug it in	Analyser
3 - Set the range selector knob on scale $10 \cdot 10^{-6}$ atm.cc/sec.	Electronic cabinet
4 - Push on the green button  As the fore-pump starts up, the needles on the galvanometer Sweep across the dials. This is normal	Analyser
5 - Turn the pilot valve knob on position 2 (the mechanical pump roughs down the diffusion pump)	Analyser
6 - When the mechanical pump stops gurgling (after a few seconds), fill the cold trap with liquid nitrogen (about 2 liters). The green light $\triangleleft 10^{-2}$ will come on after a few minutes.	Electronic cabinet $\triangleleft 10^{-2}$
7 - Diffusion pump will warm-up in about 15 minutes. Push up the lever  Green light  will come on. Pressure is about $10^{-4}$ mbar and will progressively reach $10^{-5}$ mbar.	Electronic cabinet
If filament pilot light blinks, allow a few more minutes before pushing up the lever again.	

## 5.12 - LEAK RATE CALIBRATION

The leak is directly indicated in atm.cc/sec. for Helium. (the air leak is 2.6 times smaller).

It is not worth while controlling calibration before each test, but it is advisable to test periodically the instruments good working, for sensitivity may have been changed by accidental air inlet or errors from the operator. Calibration is made with a standard leak.

Proceed as follows :

- 1 - Connect the standard leak to the inlet valve (leak rate must be about  $1.10^{-7}$ ).
- 2 - Set the range selector knob on  $10.10^{-9}$  scale. Use the "0" adjusting knob to get a reading on the leak galvanometer. It is not useful to use the  $10.10^{-10}$  position for a more accurate reading.
- 3 - Set the range selector knob on  $3.10^{-7}$  scale.
- 4 - Turn the pilot valve knob on position 1. Mechanical pump gurgles.

If necessary, open the valve of the calibrated leak, when it has one.

After 10 seconds, slowly open the inlet valve checking that the vacuum gauge needle stays in the green zone.

Green light -  - will come on when the valve is open.

- 5 - Turn the pilot valve knob on position 2.

Analyser

Electronic cabinet

Electronic cabinet

Analyser 1-  - 2

Analyser

Electronic cabinet

Electronic cabinet

Analyser

1-  - 2

- 6 - Read the leak value on the galvanometer. The measured signal slightly decreases during a few minutes on account of a helium memory effect.

Figures  $10 \cdot 10^{-10}$   $3 \cdot 10^{-10}$  read on the range selector correspond to the full scale deviation of the leak galvanometer.

For  $10 \cdot 10^{-10}$   $10 \cdot 10^{-9}$  positions, the reading will be taken on 0.10 scale.

For  $3 \cdot 10^{-9}$   $3 \cdot 10^{-8}$  : the reading will be taken on 0.3.

A 30 % error can be allowed between the reading and the value on the leak.

- 7 - To modify the deflection of the galvanometer, use the potentiometer which regulates the filament electronic current.

Electronic cabinet

- 8 - If the calibrated leak is equipped with a valve, it is possible to check that the leak meter zero is correct by closing the valve.

Electronci cabinet

- 9 - After the calibration has been done, shut the inlet valve and vent by removing the calibrated leak.

Analyser

### 5.13 - AUDIO SIGNAL

An audio signal can be used to complete the signal of the galvanometer in order to warn the user.

Threshold adjustment :

- Set the range selector knob on  $10 \cdot 10^{-9}$  scale.
- Make an equivalent helium signal with the "0" potentiometer.

Electronic cabinet

- With a screwdriver turn the threshold potentiometer.

Electronic cabinet



- Volume adjustment : turn the volume control knob.

Electronic cabinet



#### 5.14 - TESTING A SMALL VOLUME ARTICLE UNDER VACUUM

1 - Shut inlet valve.

Analyser

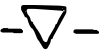

2 - Connect the article to the inlet valve by a metallic tube (better than a plastic one but not compulsory).

Analyser

3 - Set the range selector knob on  $10 \cdot 10^{-9}$  scale, which is a good range to work on. To use a remote meter, set the selector on  $3 \cdot 10^{-7}$  position.

Electronic cabinet

4 - Set the by-pass valve knob on position 1. Mechanical pump gurgles.

Analyser

5 - Wait a few seconds to a few minutes before opening the inlet valve. A 10 liter volume needs 3 minutes to be evacuated.

6 - Slowly open the inlet valve while checking the vacuum gauge meter. The needle must stay in the green zone.

Analyser



Electronic cabinet

If the inlet valve cannot be opened, put the by-pass valve on position 2, stopping meanwhile on medium position. Then try to open the inlet valve.

#### NOTE

If the filament goes off, close the inlet valve and wait 10 seconds before re-opening.

Analyser

7 - Set the pilot valve control knob on position 2.

Perform test.

#### NOTE

If tests are performed on series of small volume pieces, it is recommended to use an auxiliary roughing pump in order to prevent contamination of the detector forepump (see § 5.15).



## 5.15 - TESTING A LARGE VOLUME PIECE UNDER VACUUM

For testing pieces of over 10 liter volume, it is necessary to use an auxiliary roughing pump (mechanical pump or Roobts pump). Install a valve between the piece and the auxiliary pumping system. Use a metal pipe to connect the article to be tested to the detector. It is advisable to use a Pirani gauge (API 101) to check if the pressure is below  $1.10^{-1}$  mbar before opening the detector inlet valve.

The observation of the helium signal will be achieved while using the roughing pump at the same time. This will decrease the sensitivity but the helium response time will also be reduced.

## 5.16 - SNIFFING

The sniffing method is used for pieces under internal helium pressure.

- Connect the sniffer probe to the inlet valve and rough it as indicated in 5.14.
- Open the sniffer probe so as to get  $1.10^{-4}$  mbar on the leak detector vacuum gauge. It may be necessary to wait about 10 minutes before opening it, in order to allow the outgassing of the sniffer hose.

Analyser

## 5.17 - SHUT-OFF

Set the selector range on  $10.10^{-6}$  scale

Shut the inlet valve.

Set the pilot valve knob on position 2.

Press the red button that will switch off the main supply.

The liquid nitrogen trap will be cleaned periodically. Cleaning operation frequency depends on cleanliness of articles tested

Electronic cabinet

Analyser

Analyser



Allow 15 minutes after shut-off before removing the trap.

Use the extraction screws to remove the cold trap finger.

Clean it with alcohol and dry it with soft paper.

Re-install the trap and rough the installation (mechanical pump on for a few seconds).

#### 5.18 - INLET SAFETY VALVE OPERATION

The safety valve principle has been described in § 2.333.

While operating the leak detector, sudden air inrush may result in automatic valve shutting.

To re-open the valve, turn the knob clockwise all the way down. Switch the filament on and turn the valve knob counter-clockwise to open.

#### 5.19 - REMARKS ABOUT THE "HIGH SENSITIVITY" TESTS

ASM 10 leak detector enables to measure, at full speed,  $2 \cdot 10^{-11}$  atm.cm<sup>3</sup>/s leaks. However such a high sensitivity is not always necessary ( $2 \cdot 10^{-11}$  signal corresponds to a throughput of 2 cm<sup>3</sup> in 3 000 years).

Generally, when the acceptance threshold will be  $10^{-8}$  atm.cm<sup>3</sup>/s, the user will work on the  $10 \cdot 10^{-9}$  or  $3 \cdot 10^{-8}$  range.

Remember that the calibration must be achieved with a leak greater than  $10^{-8}$  atm.cm<sup>3</sup>/s.

## PERIODICAL MAINTENANCE OPERATIONS

Periodicity (hours)	MAINTENANCE OPERATION
200	Check the oil level of forepump
1 000	Check the analysis cell background noise at $1 \cdot 10^{-4}$ mbar (less than $10^{-8}$ atm.cm <sup>3</sup> /s.)
2 000	Check the condition and the level of the diffusion pump oil. Drain the mechanical forepump oil.
4 000	Complete cleaning of : - vacuum system - analysis cell Remove dust from fan and electronic cabinet
10000	Replace the diffusion pump heater. Mechanical forepump complete overhauling,
20000	Replace the diffusion pump fan. Replace the seals and gaskets.

## MAINTENANCE

## 5.21 - QUICK CHECKING

To make sure of normal operating conditions, it is only necessary to check the following points :

- The internal pressure of the detector, the inlet valve being open and blanked-off, must be lower than  $1.10^{-5}$  mbar.
- Zero stability rapid variations must not exceed  $\pm 3$  small divisions on  $10.10^{-7}$  sensitivity range.
- When comparing the value indicated on a calibrated leak with the leak meter reading, this latter should not be more than 30 % lower (after adjustment of the helium peak)

If one of the above conditions is not fulfilled, see § 5.4 - trouble checking.

## 5.22 - COMPLETE OVERHAUL

After dismantling and cleaning all the parts of the analyser unit, a complete test will be made with the following operations :

- Electrometer tubes balancing § 4.232
- Electrometer current adjustment § 4.222
- Filament protection § 4.222
- Inlet valve test § 4.222
- Amplifier zero stability test
- Helium signal stability test.



## TROUBLE CHECKING

If several detectors are used, it will be easier to locate any defect by substitution of interchangeable parts such as amplifier, pre-amplifier or connection cable.

## 5.41 - MECHANICAL PUMP MOTOR

Difficult on start-up.

- Normal if the temperature is lower than 10° C
- Use a heater if necessary.

## 5.42 - INLET SAFETY VALVE

The valve does not open.

- Check if coil is energized :  
5.5 V.D.C. between P08.1 and P08.  
(plug disconnected, if necessary see § 2.33.)
- Check if pilot light is energized  
5.5 V.D.C.
- Check coil terminals P08.3/P08.2
- Check bulb.

The pilot light  does not light up.

## 5.43 - PUMPING SYSTEM

Liquid nitrogen keeps on boiling several minutes after start-up.

- Check the mechanical pump oil level
- Check the cold trap o-ring.  
The cold trap may be dirty.
- Could be a leak in the vacuum circuitry :
  - Close the inlet valve
  - Leak check the vacuum circuitry with helium.
  - Check the cleanliness and the level of the diffusion pump oil.

Pressure stays over  $1.10^{-5}$  mbar 30 minutes after the diffusion pump has been turned on.

## 5.44 - AMPLIFIER ZERO SETTING

No possible adjustment.

- Perform the adjustment described in § 4.232.
- If possible, use another pre-amplifier or another electronic cabinet

The leak rate meter needle swings suddenly to the left and sticks there for several minutes before returning to its normal position.

Zero is unstable on scale  $10.10^{-10}$  (more than  $\pm 3$  small divisions).

#### 5.45 - ANALYSIS CELL

The filament light does not light up.

On filament switch on, pressure rises and filament goes off.

No helium signal with calibrated leak on.

- Electrical parasite due to
  - Mains power
  - A wire broken in a cable or a plug.
  
- Try to substitute a spare pre-amplifier, adjust polarities as indicated in § 4.232.
  
  
  
  
- Check the bulb and voltage at bulb contacts.
- Check the filament continuity circuits between J06.1 and J06.!
- Check filament power supply (see electrical diagram).
  
- Clean the analysis cell (§ 2.1342).
  
- Make sure the inlet valve is open and the filament has been switched on.
- Adjust "helium peak" potentiomet (electronic cabinet front panel)
- Check electronic current is 1 mA (1 V.) on R8 1 terminals.
- Make sure acceleration voltage between P06.4 and P06.6 is about 200 V.
- Make sure the magnet is properly installed with "N" stamped pole facing the rear of the cabinet.

Lack of sensitivity

Large helium signal without calibrated leak at ultimate pressure (lower than  $10^{-5}$  mbar).

More than 50 % less on helium signal between  $10^{-6}$  and  $10^{-4}$  mbar.

Helium signal instabilities : peaks with periods of a few minutes.

Erratic peaks.

- Dismantle the analysis cell, check it is clean. Make sure the filament alignment is correct.
- Check the electrodes of the analysis cell are not shorted with ground.
- There is probably a short-circuit between ground and ionization chamber if the filament light brightness varies when acceleration voltage is varied.
- Dismantle the analysis cell. Check the filament cleanliness and its alignment.
- Change the electron collector.
- Clean the analysis cell and its chamber.
- It could be necessary to use fine abrasive cloth to remove insulating material which are not visible (§ 2.1342).
- Is diffusion pump hot ?
- Is mechanical pump rotating ?
- Is there any helium in the room ?
- Check level and cleanliness of diffusion and mechanical pump oils.
- Shut the inlet valve. If signal goes off, clean the inlet valve.
- If signal does not go off, clean the analysis cell.
- Clean the analysis cell and change the electron collector.
- Clean the inlet valve.
- Do not use grease.
- Drain and change diffusion pump oil

## SPARE PART KIT

220 V. - 50 Hz.

DESCRIPTION	PART NUMBER
5.51 - <u>Common parts to :</u>	
ASM4 P - ASM4 A - ASM7 - ASM8 - ASM9 - ASM 10 - DGC Leak Detectors	
1 Mechanical pump oil charge	10 990
1 Diffusion pump oil charge - Octoil	83 463
1 Diffusion pump heater A 422 524	53 087
1 Complete filament assembly	53 146
1 Lead wire 0.8 mm dia. x 2 m.	83 478
1 Screw CH 2 L4	83 489
1 Washer Trepp 6 mm. dia.	83 486
1 Electron collector	83 485
1 Pre-amplifier	86 393
1 Time counter	84 672
1 Pirani filament PI 1 A 433 731	57 972
5.52 - <u>ASM 10 specific parts</u>	
1 Printed board E01 A 313 836	67 517
1 Printed board E02 A 313 835	67 516
1 Potentiometer R 103	37 519
1 Potentiometer R 104	87 554
1 Potentiometer R 105	87 552
1 Potentiometer R 108	37 512
1 Potentiometer R 109	37 511
2 Diodes CR 13 - CR 14	87 380
1 Transistor Q 15	87 406
2 Fuses F 01	60 519
1 Galvanometer M 02	55 490
1 Switch S 02	60 300
1 Transistor T 01	55 499
3 Bulbs for light DS 01 - DS 02 - DS 03	37 570
1 Solenoid coil (safety valve) A 428 587	55 841

Qty	Description	Warehouse Number
1	Filament	53 146
1	Diffusion pump octoil oil	84 363
2	Trap extraction screws	82 628
1	Hook for diffusion pump	67 538
1	∅ 5 mm allen key	81 141
1	Trap support	67 537
1	Tube containing : - 2 fuses : D1 TD 0.5. A. - 1 midget bulb 24 V. 50 mA - 1 bi-pin bulb 24 V. - 2 fuses D1 TD. 0.05. A - 1 Pirani filament	60 619 60 007 60 524 57 972
1	Tube containing : - 1 electron collector - 5 CM2 L4 screws	83 485 83 489
1	Tube containing : - metal gasket - metal gasket - lead gasket	53 147 83 476 83 478
1	Tube containing : - 3 micro midget bulbs 5.	60 041
1	Tube containing : - 3 micro midget bulbs 24 V.	
1	Screw driver	
1	Can of oil for vane pumps	10 990

## " MASS 2,3,4." OPTION

Some users would like to detect tracer gases which are different from helium : hydrogen (mass 2) or helium 3 (mass 3). For this purpose, ASM 10 leak detector can be supplied with a "3 mass" electronic cabinet, and a special magnet.

### 6.11 - DESCRIPTION (fig. 13)

A set of 3 push-buttons is situated on the front panel of the electronic cabinet. To select one of the three gases (mass 2, 3, 4) the user must press the corresponding button. To set the accelerating voltage, proceed as for the standard helium leak detector : connect a standard leak of the gas used and set the potentiometer below the corresponding button, to get the maximum reading on the leak galvanometer.

It is not necessary to use a hydrogen standard leak to set the hydrogen leak. The setting can be achieved on the "hydrogen noise" which is always over  $10^{-7}$  atm.cm<sup>3</sup>/s.

The analysis cell magnet is the standard magnet of the detector. Its magnetic field is 1 300 gauss instead of 1 650 gauss for the standard magnet.

### 6.12 - HYDROGEN LEAK DETECTION

It is a difficult operation to test a leak with hydrogen tracer.

- On one hand, hydrogen is a dangerous product.
- On the other hand, there is a hydrogen background in the detectors, either from the walls outgassing or the ionisation of hydrogen compounds.

- After the cleaning of the nitrogen trap, it is necessary to let the detector run for a few hours until you get a hydrogen signal inferior to  $10^{-6}$  atm.cm<sup>3</sup>/s. To save time it is advisable to let the detector run day and night. It will be important to keep nitrogen in the trap.
- After about twenty hours' use, hydrogen noise must be below  $5 \cdot 10^{-7}$ .
- When the instrument is running day and night, it is suitable to stop it one time a week to clean the trap.

## GROSS LEAK OPTION

There are nine ranges in the standard ASM 10. It is possible to achieve measurements between  $10^{-9}$  and  $10^{-5}$  full scale.

Some users prefer a  $10^{-8}$  -  $10^{-4}$  range.

ASM 10 detector can be supplied with such a range. The pre-amplifier inlet resistor whose normal value is  $6.10^{11} \Omega$ , is  $6.10^{10} \Omega$  in this case.

Any other range can be supplied on request.



6 - 3

OPTION 60 HZ. - 115 V.

ASM 10 detector can be supplied for 60 Hz. - 115 V. mains supply.

Differences between 115 - 60 Hz. model and 50 Hz - 220 V. model are as follows

- Vane pump motor
- Timer
- Circuit breaker
- Diffusion pump heater
- Blower
- T01 special connection
- Electronic cabinet fuse.

This device is intended to enable a sniffing operation to be carried out by means of a helium mass spectrometer on an object situated more than a few meters away from the detector.

## I- PRINCIPLE

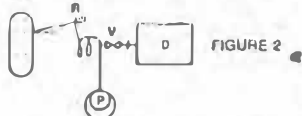

For distances under 2 meters the probe is connected directly to the detector D (fig 1). For distances over a few meters, an auxiliary pump must be used, which enables the tracer gas to be carried in viscous flow, in order to obtain the right transfer speed. The detector is then connected in parallel to the sniffing circuit by a valve or a diaphragm V (fig 2).

This method is inconvenient because the user has to add a pumping device (membrane or vane pump too bulky to be included in the housing of a portable detector, and necessitating a connection to a mains supply).

The Alcatel system, called L.D. (long distance), allows the tracer gas to be transferred in viscous state without adding an extra pumping apparatus to the mass spectrometer.

## 2- DESCRIPTION

Fig 3 gives a conventional diagram of the spectrometer detector:

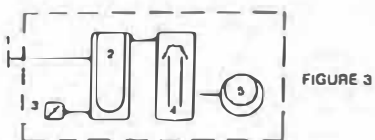

1. Inlet port
2. Nitrogen trap.
3. Analyser cell.
4. Diffusion pump.
5. Vane pump.

One could imagine connecting the sniffing probe to the inlet port of pump n°5. This unfortunately is impossible: to obtain an acceptable transfer speed, the pressure in the pump would have to reach too high a degree, incompatible with the working of the diffusion pump.

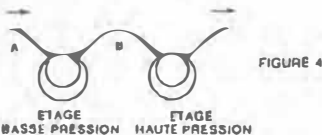

However, if the design of pump 5 is examined more closely, it will be noted that this device generally comprises 2 pumping stages in series (fig.4)

So the idea was hit upon of installing a derivation between the 2 stages at point B where pressure can build up without perturbing the diffusion pump coupled at A.

This leads to diagram 5. The sniffer probe, made of a stainless steel capillary tube, is connected to the detector housing by means of a thin plastic tube and a pneumatic coupling K. This enables the probe to be easily connected or disconnected when the sniffing method is needed.

The gas flow through the probe across a sampling device D (porous membrane) and is then evacuated by the high pressure stage of the vane pump P.

An electromagnetic valve closes automatically in the event of a mains supply failure, in order to avoid an air inrush on the diffusion pump when the valve pump comes to a stop.

## 3- PERFORMANCE

Detection of leaks ranging about  $1 \cdot 10^6$  std. CM<sup>3</sup>/S.

Transfer speed of helium: 1 M/S

Pressure in analysis cell:  $2 \cdot 10^5$  MB.

## 4- OUTSTANDING FEATURES

- Ease of Operation: The probe is a metallic type pencil  $\varnothing$  3 mm, connected by a plastic tube  $\varnothing$  4 mm, to a pneumatic coupling fixed on the an analyser's front plate. The probe can be rapidly connected or disconnected without perturbing the operation of the analyser. There is no need for a mains supply.

- Easily Fitted: The L.D sniffers can be fitted to any detector Alcatel ASM 10, ASM5, DGC5, DGCIC Bulk is negligible. The extra weight being about 100gr.

- Reliability: There are no mobile components (needle valves) therefore no readjusting needed. The probe is fitted with a filter easily replaced when the pressure drops below  $2 \cdot 10^5$  mb. This reduces the wear of the filament.

## -5 DIRECTIONS FOR USE

All that is necessary is to connect the quick pneumatic coupling and check that this operation increases the triode pressure to  $2 \cdot 10^5$  mb

## FIGURES AND DRAWINGS

Fig. 1 Schematic diagramm

- 2 ASM 10 leak detector picture - Complete
- 3 ASM 10 leak detector picture - Diffusion pump side
- 4 ASM 10 leak detector picture - Analysis cell side
- 5 Electronic cabinet picture (front)
- 6 Electronic cabinet picture (inside)
- 7 Operating principle of the analysis tube
- 8 Analysis cell picture (outside view)
- 9 Analysis cell picture (inside view)
- 10 Preamplifier
- 11 View of the inlet valve
- 12 Electrical diagramm
- 13 Mass 2, 3, 4 power supply unit
- 14 Analysis cell, exploded view.

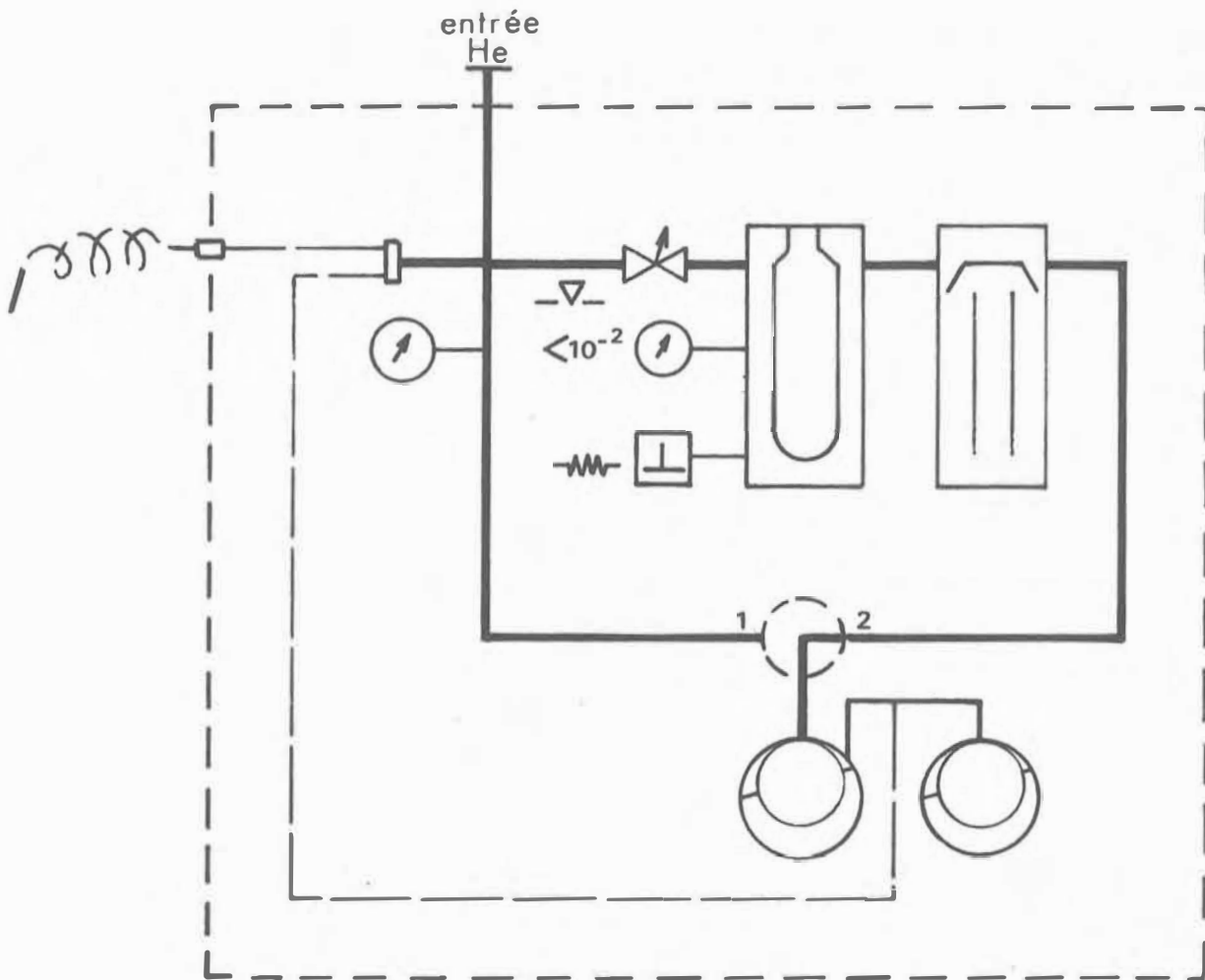

SCHEMA SYNOPTIQUE

FIG 1

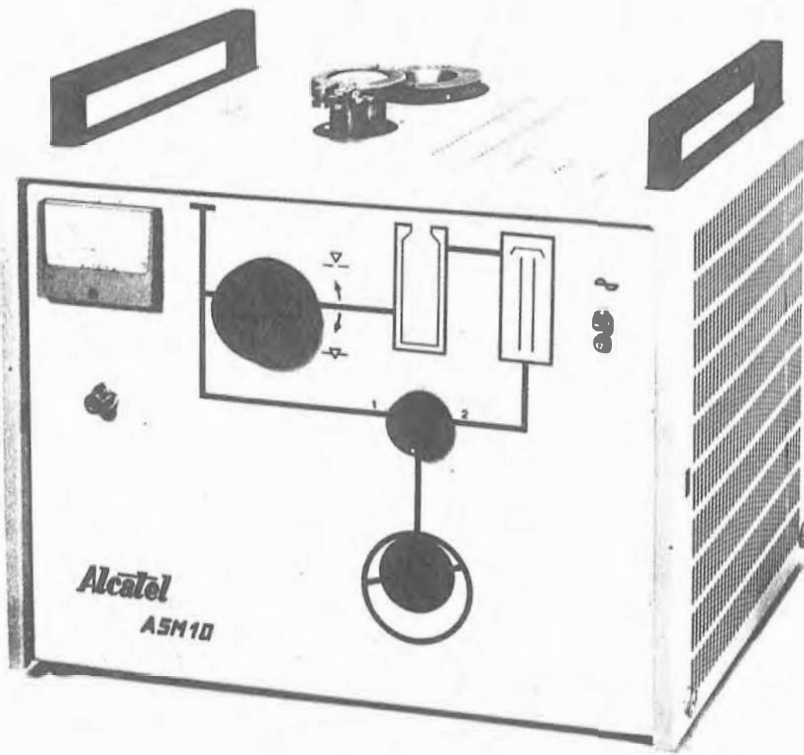

ASM 10 Leak detector picture complete

Figure 2

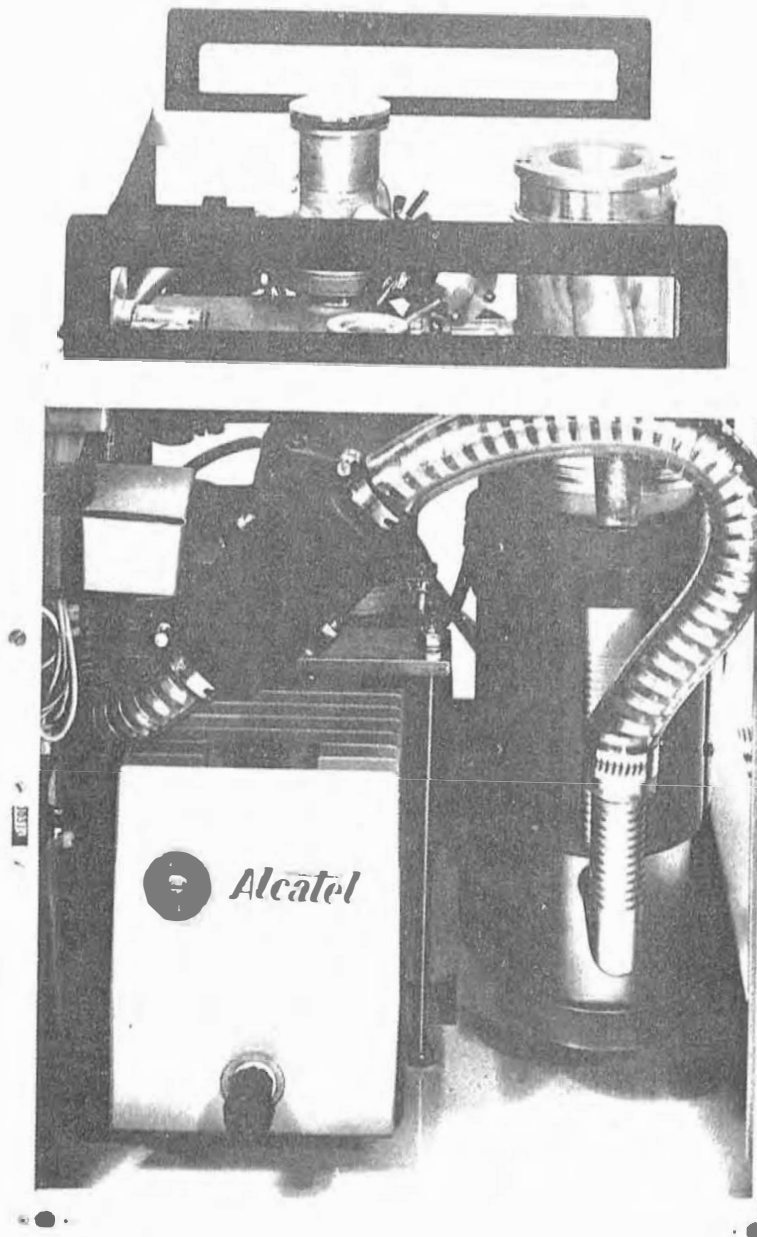

Diffusion pump side

Figure 3

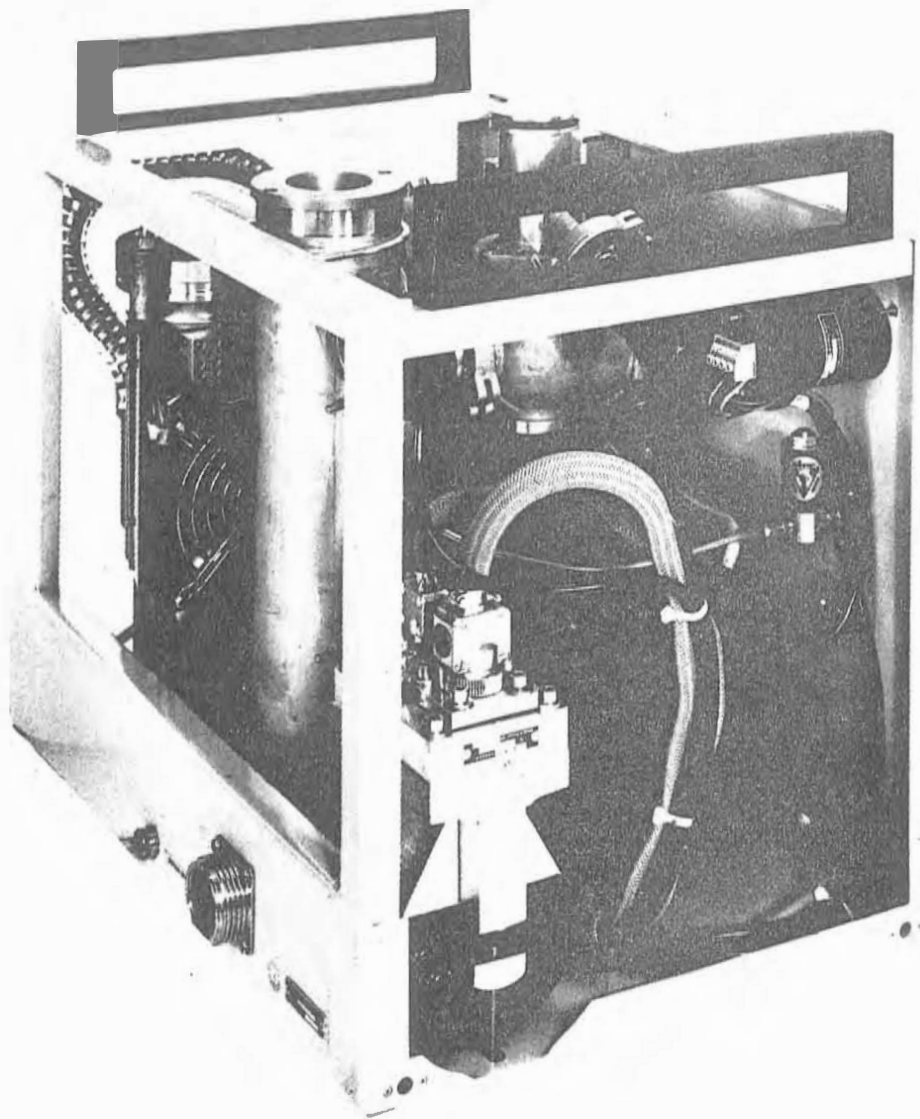

Analysis cell side

Figure 4

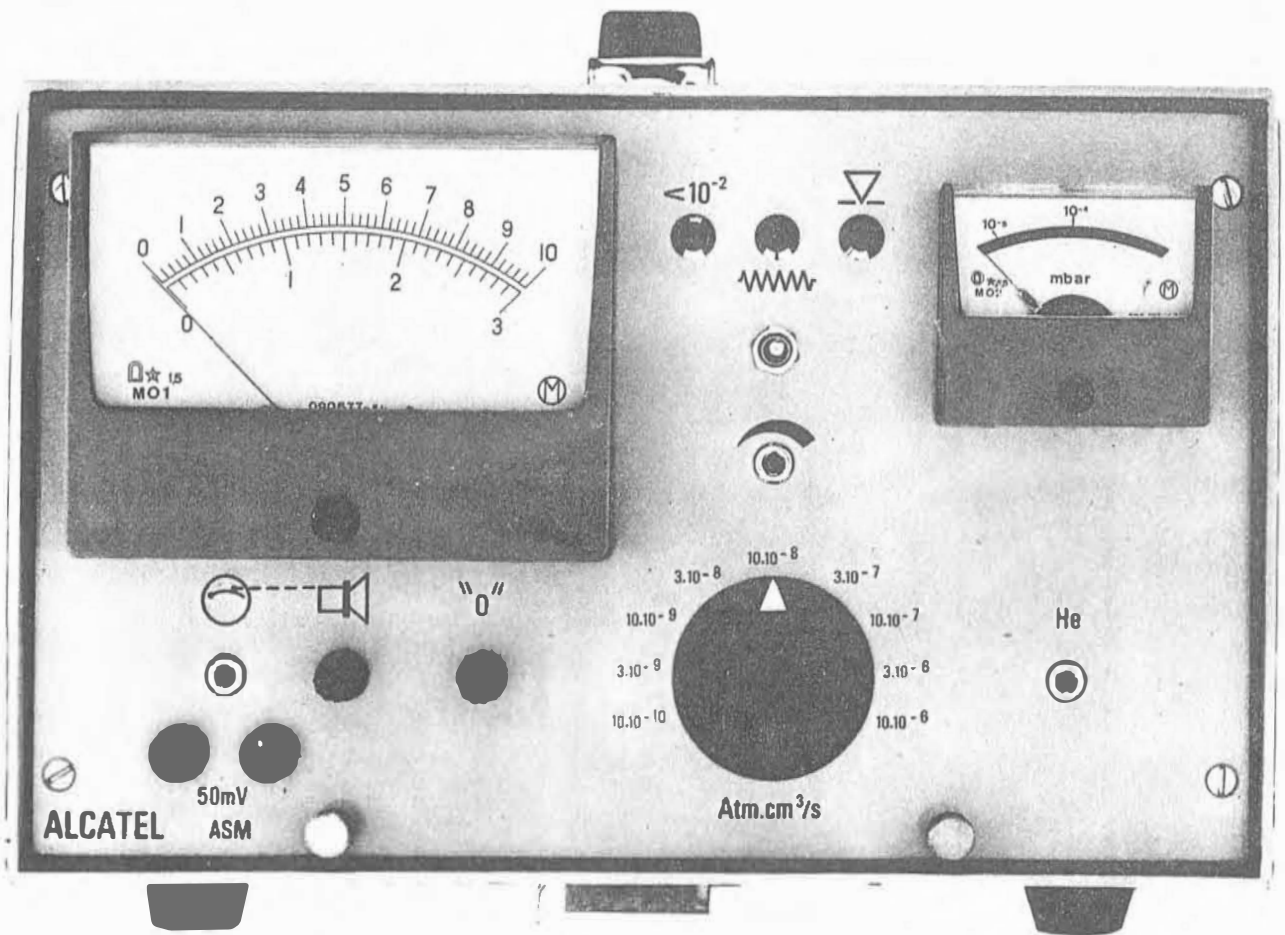

Electronic cabinet (front)

Figure 5



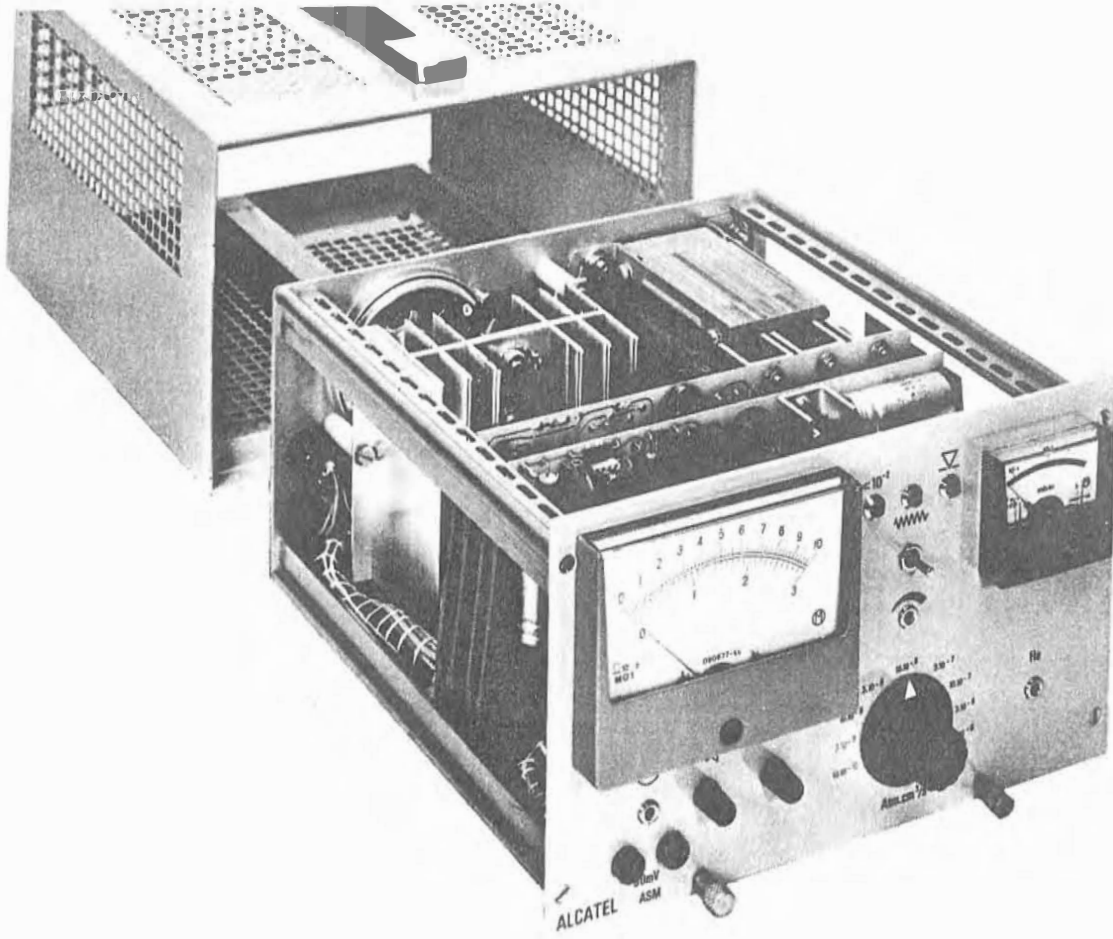

Electronic cabinet (inside)

Figure 6

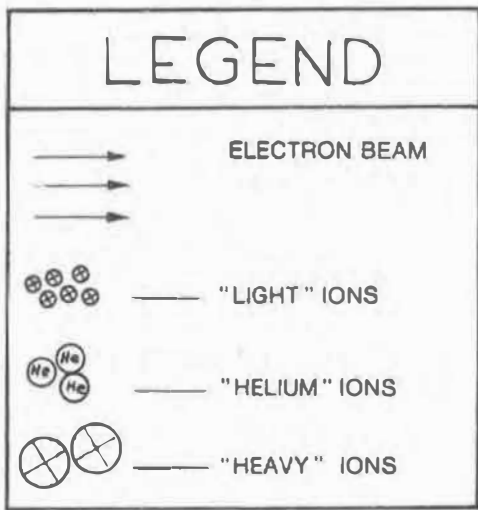
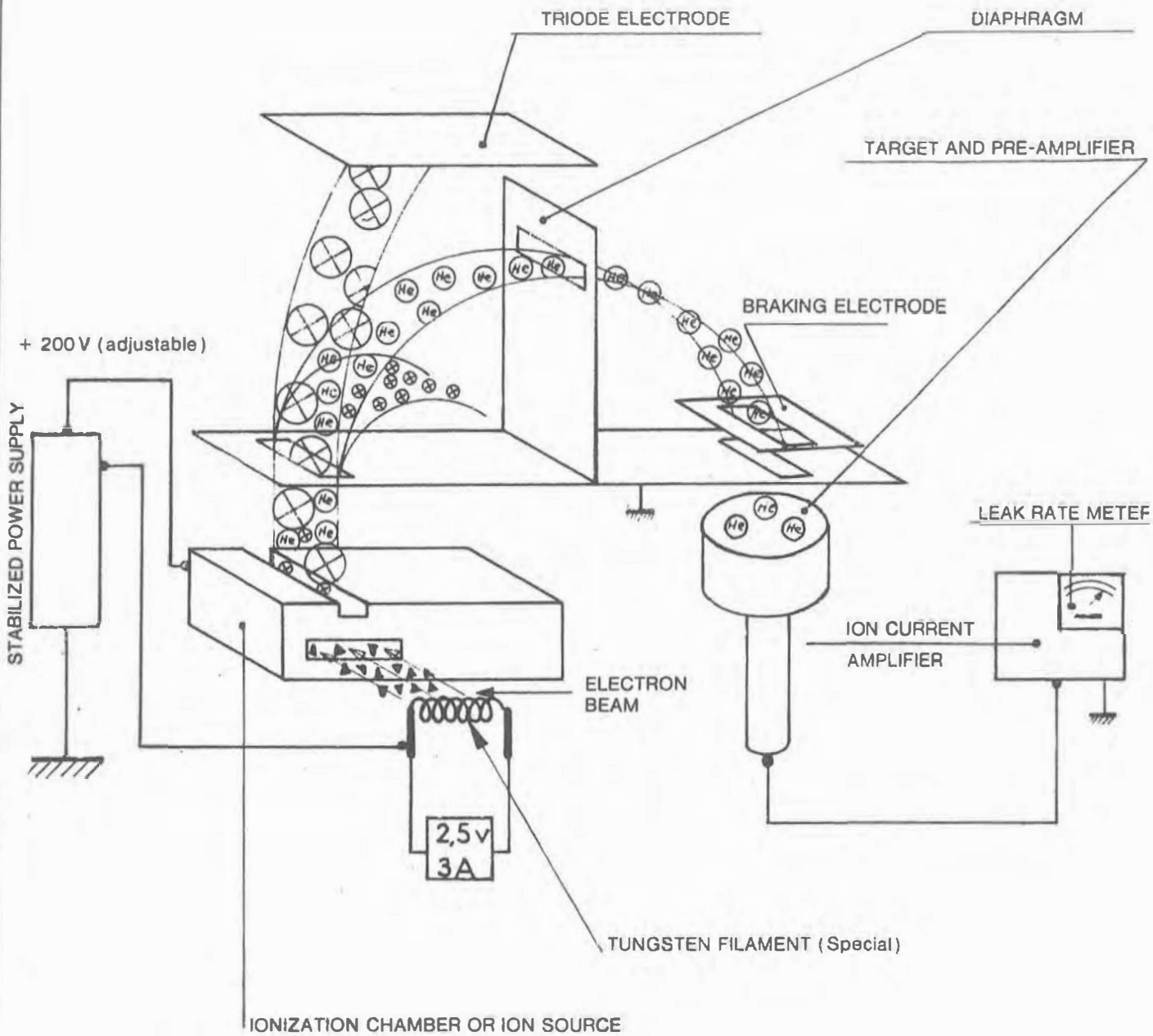

**OPERATING PRINCIPLE OF THE ANALYSIS TUBE**

**FIGURE 7**

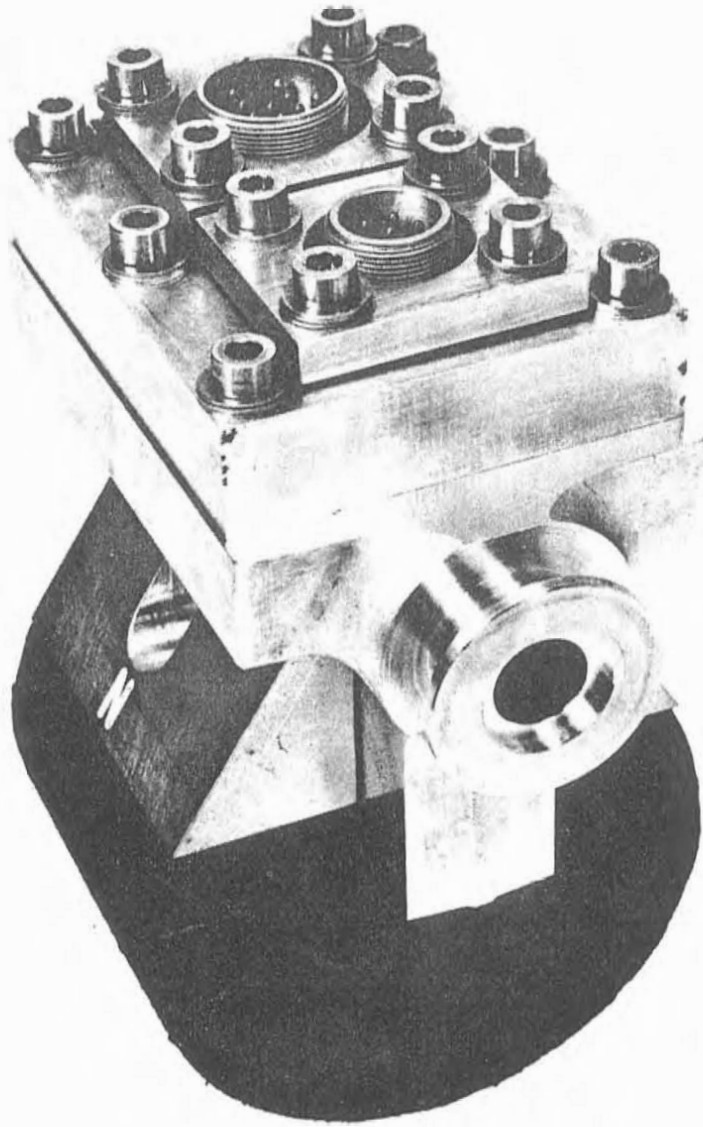

**ANALYSIS CELL (OUTSIDE VIEW)**

**FIGURE 8**

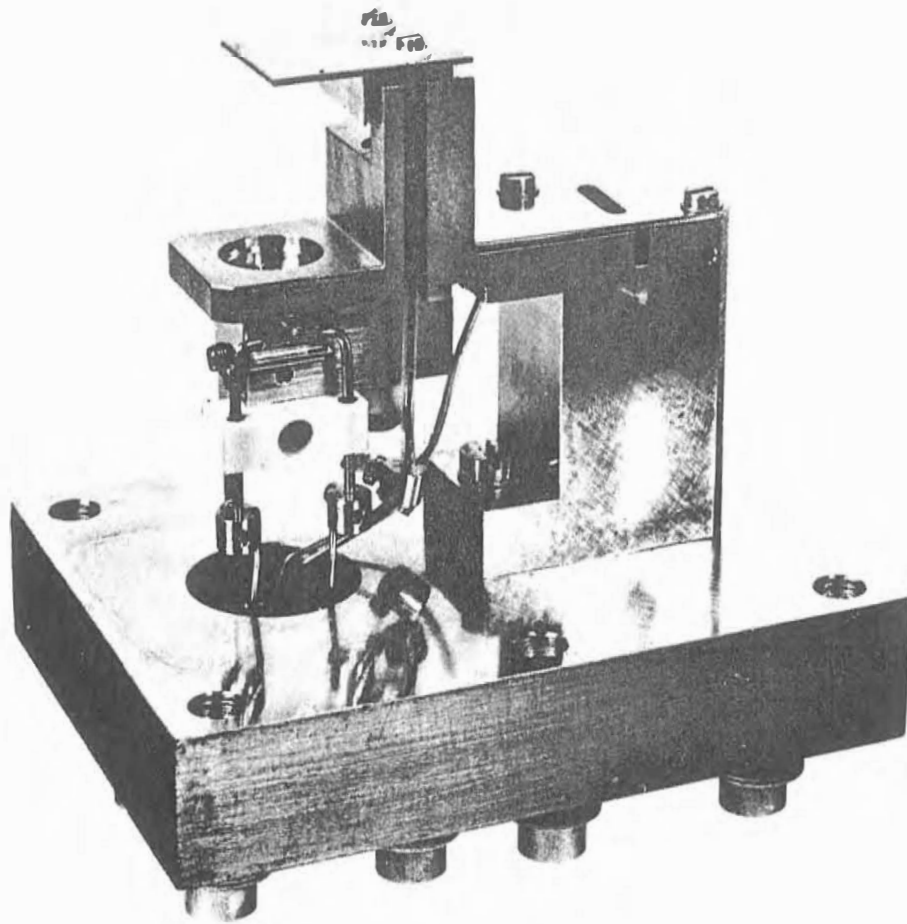

**ANALYSIS CELL (INSIDE VIEW)**

**FIGURE 9**

PRISE D'ALIMENTATION

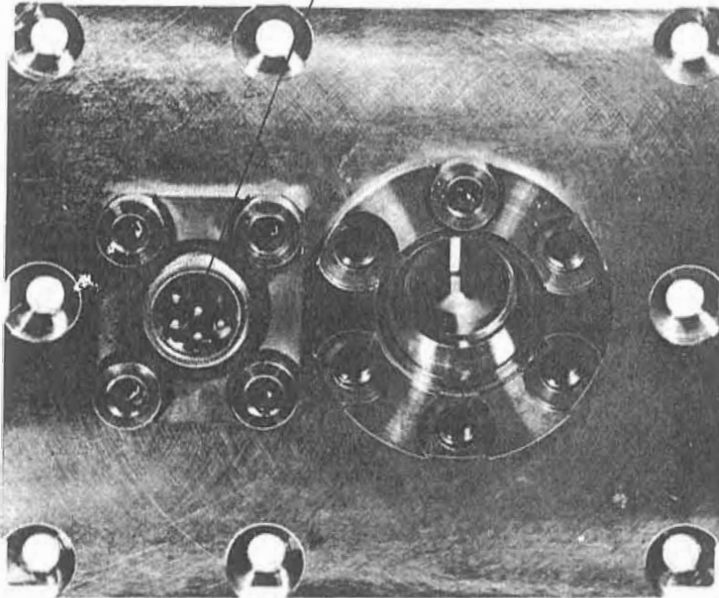

CIBLE

RESISTANCE 60 10 "  $\Omega$

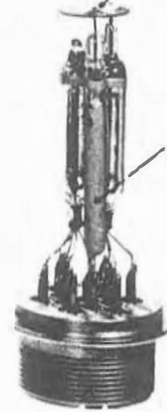

**PREAMPLIFIER**

**FIGURE 10**

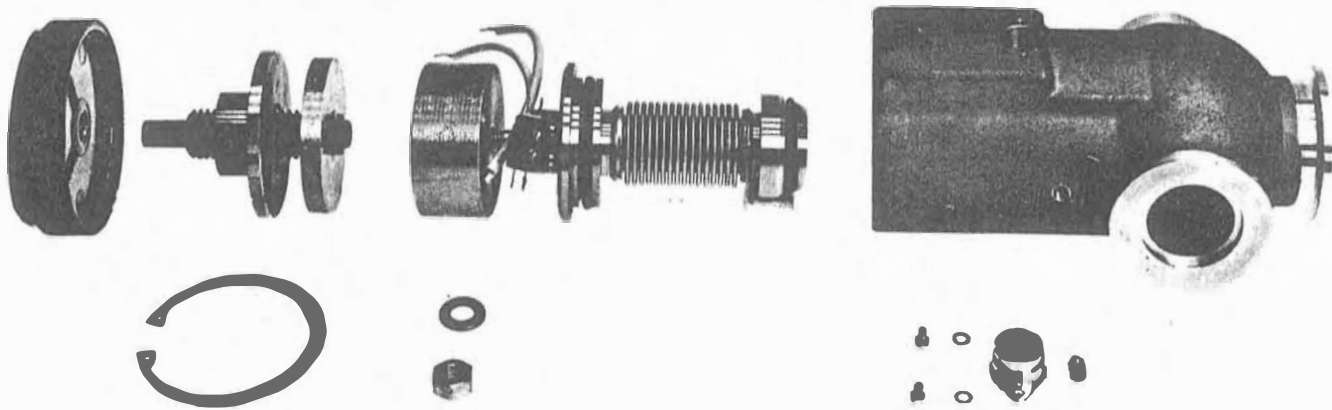

**VIEW OF THE INLET VALVE**

**FIGURE 11**

ELECTRICAL DIAGRAM ASM 10

FIGURE 12

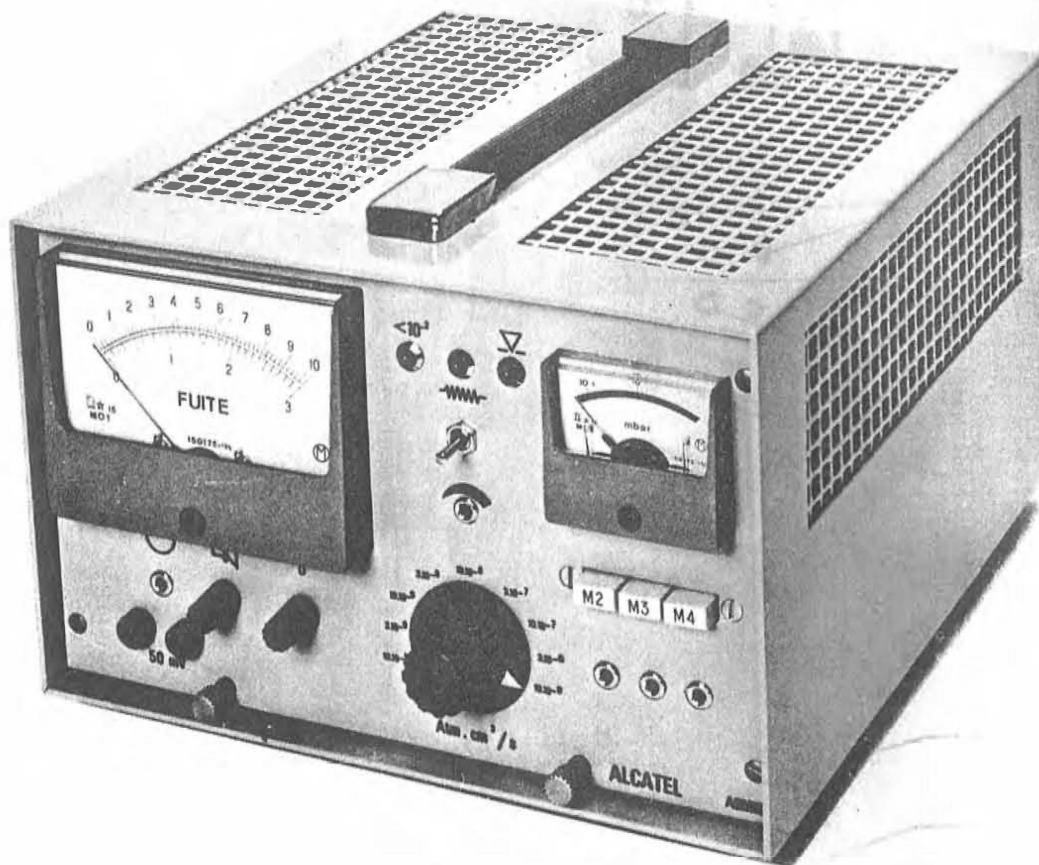

MASS 2.3.4 POWER SUPPLY UNIT

FIGURE 13



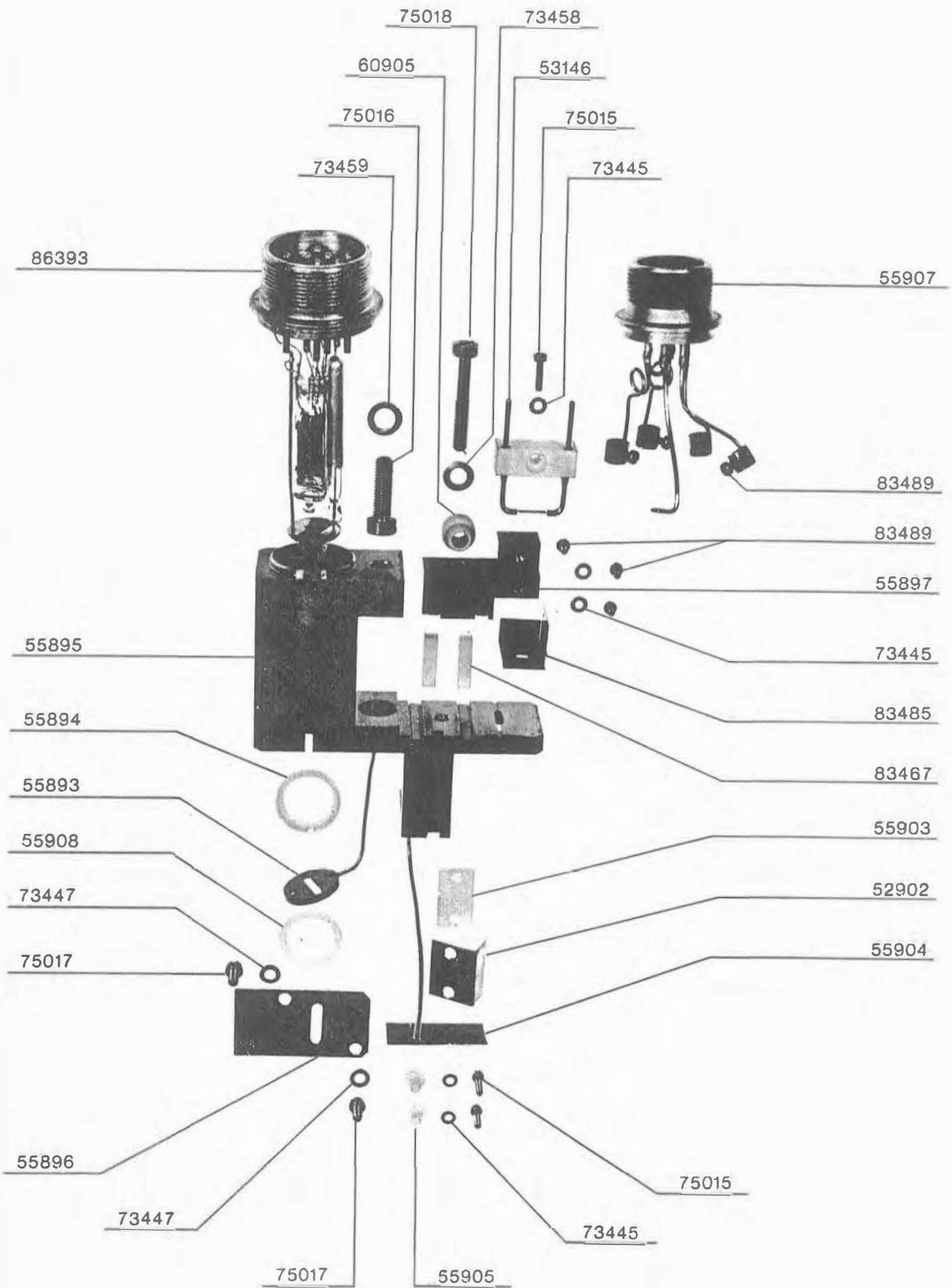

Analysis cell, exploded view

FIGURE 14

## Notes

E02 Board Relay Safety to protect vacuum system -

- Includes Relays K01 & K02
- Relay K02 closes when High vacu param: gauge reaches  $6 \times 10^{-2}$  mbar ( $\approx .04$  Torr)
- Relay K02 will not close if filament is open
- Green light  $> 10^{-2}$  mbar will not come on until K02 or E02 closes.
- when K02 closes diffusion pump gets power.
- K02 closes [K03 & K04] <sup>Asm-10 only</sup> on inside of Leak Detect Cabinet. near main power switch Button.
- 115 VAC Diff pump heaters are  $36 \Omega$ .
- high vac pressure is high when Diff pump fan is frozen.
- There is a thermal switch behind Diff pump fan that should be closed to complete diff pump K02 circuit.

- Diff pump thermal switch is easy to short never metal case and will not allow  $\text{EOZ}$  to energize.
- Most parts on ASM-10 are compatible w/ ASM-51 (Factory Board EO1 & EO2).
- Metal basket is .8mm lead wire @ 50 / 10 meters Alcatel.
- Do not use silicon based diff pump oil (cause pressure and the signal to oscillate).
- Low diff pump fluid causes the signal & high-vac pressure to oscillate.
- The signal is pressure dependent. If diff pump pressure oscillates so will signal.

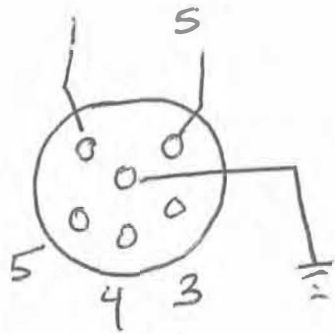

1-5 filament.

3Ω across 1-5.

6 Ground.

5, 4, 3 are all

separate high voltage plates.

1-5 3Ω

6 - Case → 0.1Ω

5 - Case → ∞Ω

4 - Case → ∞Ω

3 - Case → ∞Ω

or Anything

1 - Case ∞Ω

5 - Case ∞Ω

or anything other other

Not a dead  
shorted source

Diff pump need

Octoil

63ml charge

32.5g per charge  
from Alabon

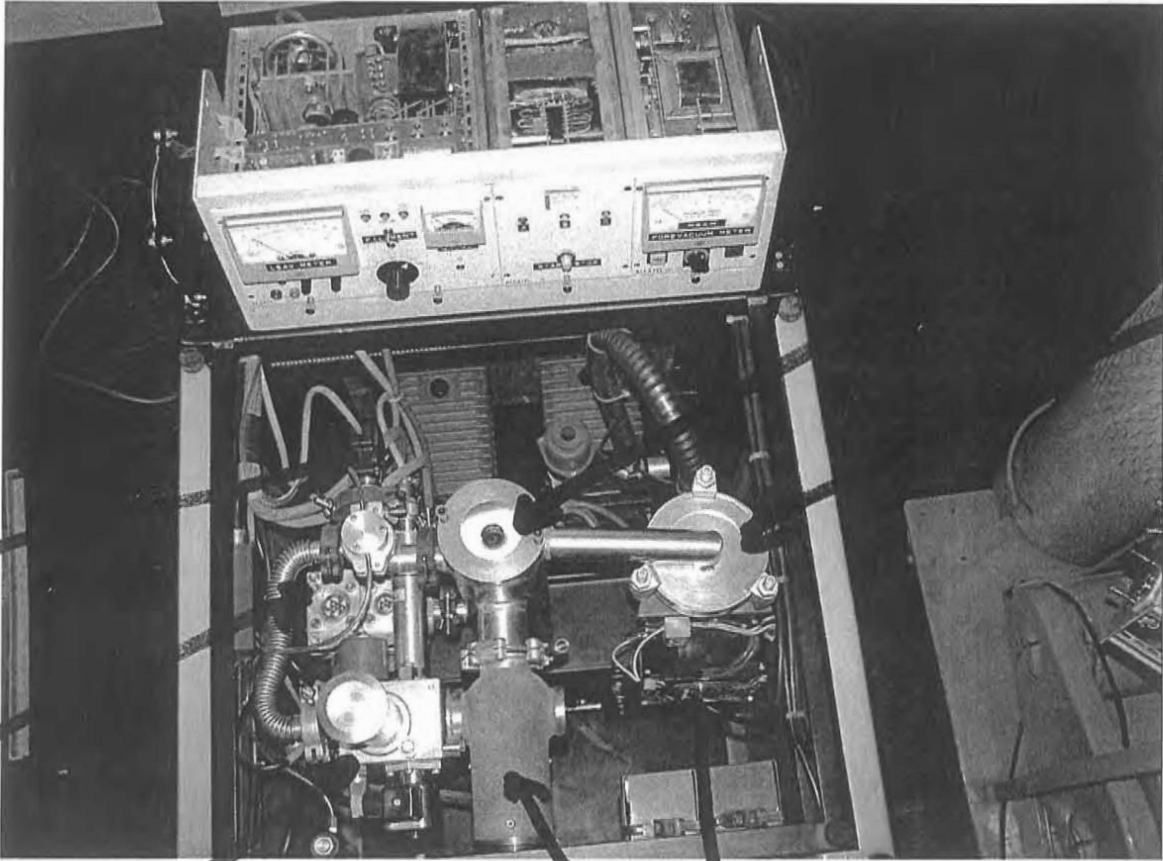

Test Port.

Throttle Valve

Spec. tubz.  
Collector: Filament

High + Vac Paraw  
Gauge.

Diff Pump

Cryotrap

Diffusion Pump  
Cooling fan.

# Alcatel ASM

100\_4273.jpg (1200x900x24b jpeg)

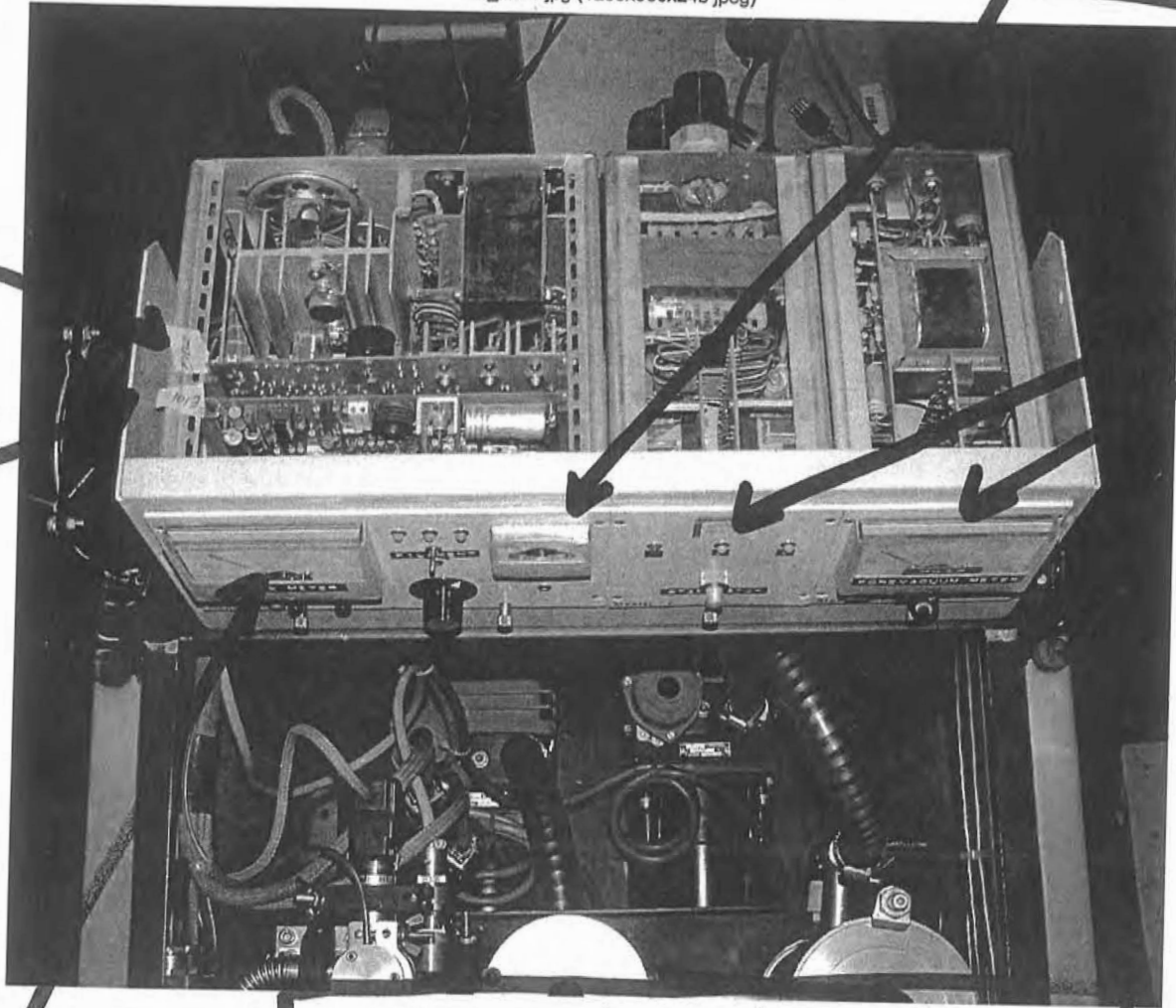

E02 Board Safety Vacuum Relay

E01 Spectrometer Board

hi-VAC Pressure  
Gauge Displ.

Test Point Pressure

Auto Valve Network

LEAK RATE  
METER

# Alcatel. ASM 10 & ASM 51

100\_4281.jpg (1200x900x24b jpeg)

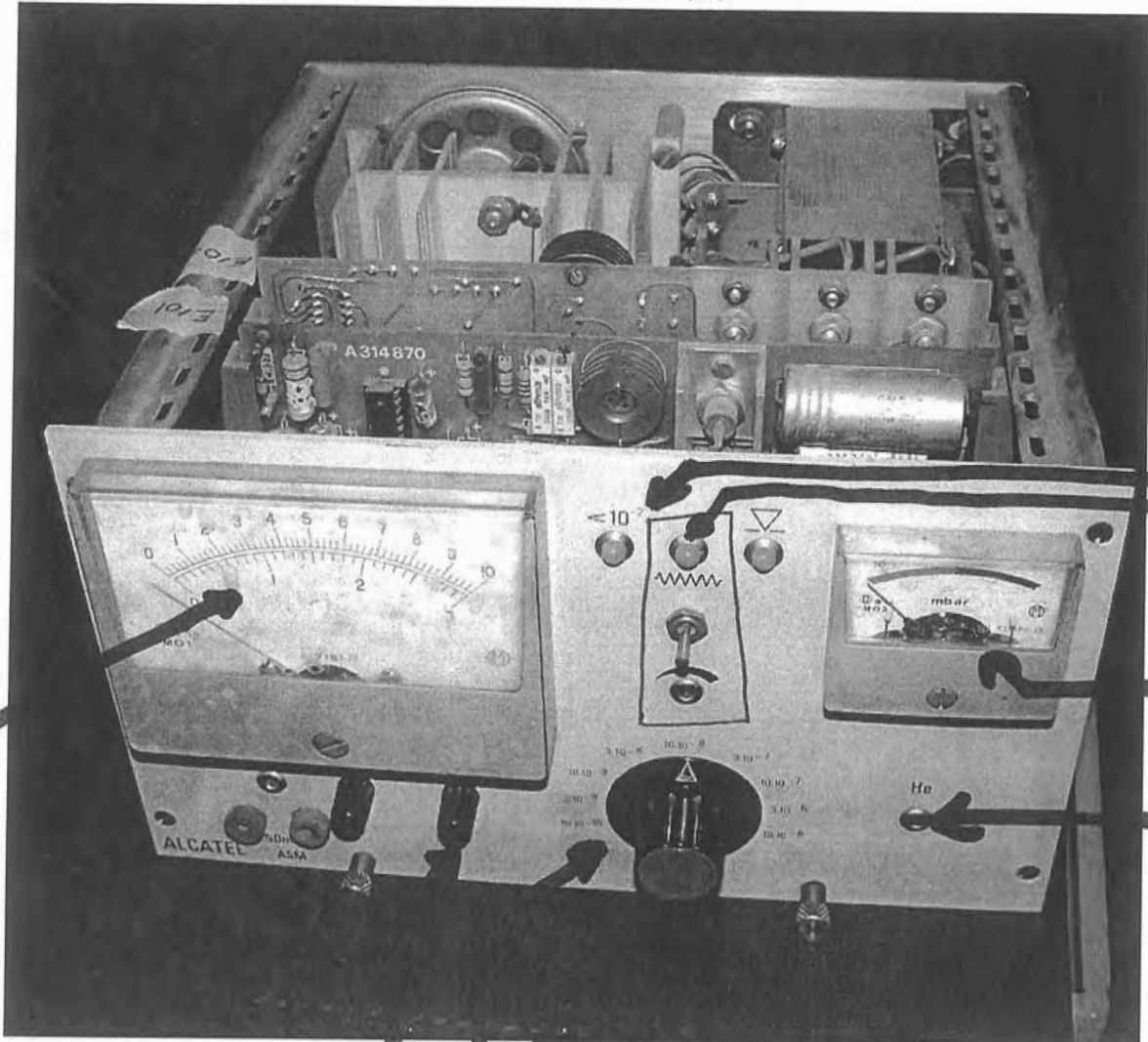

LEAK RATE

LEAK RATE  
SELECTOR

hi-VAC gauge  
for spectrometer  
comes on when  
filament lights

$<10^{-2}$  Pirani Gauge  
H: -VAC  
EO2 Boad Relay

Turn Full  
Right (clockwise)  
then 2 Turns  
Left should  
zero?

2 Filament light  
2 Filament ON/OFF switch  
3 Filament current  
Pot

Helium Peak  
POT

# Alcatel ASM-10 + ASM-51

100\_4282.jpg (1200x900x24b jpeg)

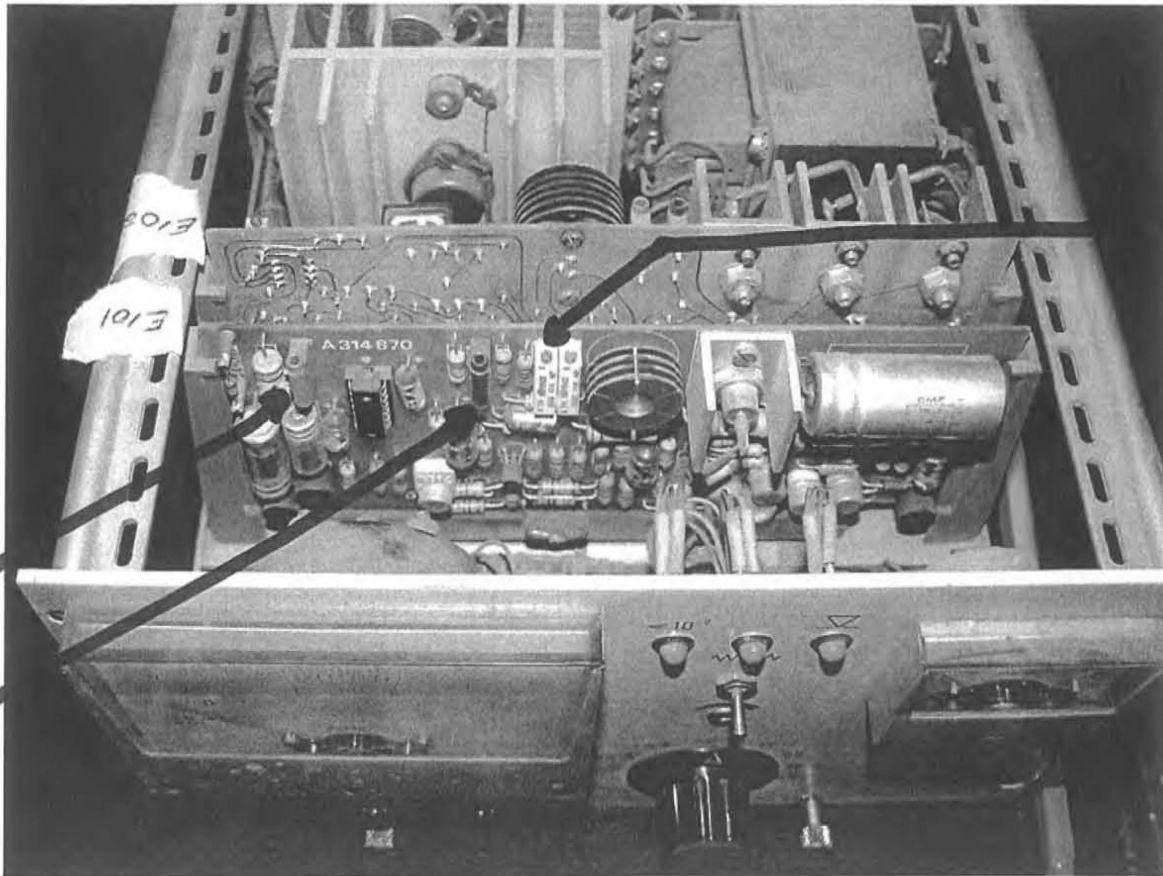

E01 + E02 Boards

E02 Safety Interlock system Board.

Turns on Diff pump when pressure on  
hi-VAC is less than  $>10^{-2}$  mbar ( $\approx 0.6$  Torr).

E01 Spectrometer board.

Preamplifier. + Amplifier.

↑

↓ DMV should be 7.75 VDC

Adjust to 7.75 VDC.



100\_4271.jpg (1200x900x24b jpeg)

