

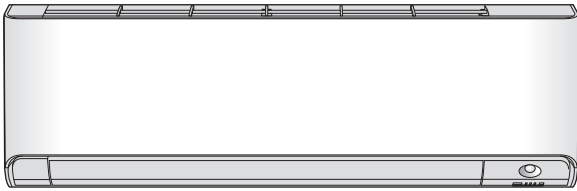

DAIKIN ROOM AIR CONDITIONER

# OPERATION MANUAL



**INVERTER**



## MODELS

FTXM20WVMA  
FTXM25WVMA  
FTXM35WVMA  
FTXM46WVMA

FTKM20WVMA  
FTKM25WVMA  
FTKM35WVMA  
FTKM46WVMA



### [Sticker attachment area]

Attach the SSID&KEY sticker of wireless LAN connecting adapter to the sticker attachment area and keep safe.

# Features

## Enhanced comfort, energy savings and air cleaning



### INTELLIGENT EYE

The INTELLIGENT EYE sensor detects human movement and adjusts the right and left airflow direction. If no one is in the room for more than 20 minutes, the operation automatically changes to energy saving operation. The INTELLIGENT EYE sensor works differently depending on the situation. ▶Page 21



### WEEKLY TIMER

Up to 4 timer settings can be saved for each day of the week according to your family's life style. The WEEKLY TIMER allows you to set on/off times and the desired temperature. ▶Page 28



### MOLD PROOF

The MOLD PROOF function dries the interior of the indoor unit and provides an ideal environment to suppress the generation of mold for the indoor unit. ▶Page 17



### FLASH STREAMER AIR CLEANING

Flash streamer decomposes mold and allergic substances. It keeps air in the room and the inside of the air conditioner clean to make a comfortable space. ▶Page 19

## Other functions



### COMFORT AIRFLOW

The airflow direction is upward while in COOL operation, and downward while in HEAT operation. This function prevents cold or warm air from blowing directly on your body. ▶Page 20



### OUTDOOR UNIT QUIET

OUTDOOR UNIT QUIET operation assures a low noise level of the outdoor unit. This function is useful to maintain a quiet neighbourhood. ▶Page 24



## ECONO

This function enables efficient operation by limiting the maximum power consumption. It is useful when using the air conditioner and other electrical devices simultaneously on a shared electrical circuit. ▶ Page 24

# Contents

## Read Before Operation

Safety Precautions.....	3
Names of Parts .....	5
Preparation Before Operation .....	10

## Basic Operation

AUTO · DRY · COOL · HEAT · FAN Operation .....	13
Adjusting the Airflow Rate.....	15
Adjusting the Airflow Direction .....	16

## Useful Functions

MOLD PROOF Operation .....	17
FLASH STREAMER AIR CLEANING Operation.....	19
COMFORT AIRFLOW Operation.....	20
INTELLIGENT EYE Operation.....	21
POWERFUL Operation.....	23
ECONO / OUTDOOR UNIT QUIET Operation .....	24

## TIMER Operation

ON/OFF TIMER Operation .....	25
WEEKLY TIMER Operation.....	28

## System control via Smart Control

Wireless LAN connection.....	34
------------------------------	----

## Care

Care and Cleaning.....	38
------------------------	----

## When the Need Arises



FAQ.....	42
Troubleshooting .....	43





# Safety Precautions

	<b>Read the precautions in this manual carefully before operating the unit.</b>		<b>This appliance is filled with R32.</b>
---	---	---	---

- Keep this manual where the user can easily find it.
- The precautions described herein are classified as **WARNING** and **CAUTION**. They both contain important information regarding safety. Be sure to observe all precautions without fail.

 <b>WARNING</b>	Failure to follow these instructions properly may result in personal injury or loss of life.
 <b>CAUTION</b>	Failure to observe these instructions properly may result in property damage or personal injury, which may be serious depending on the circumstances.

 Never attempt.	 Be sure to follow the instructions.	 Be sure to establish an earth connection.
--	---	---

- After reading, keep this manual in a convenient place so that you can refer to it whenever necessary. If the equipment is transferred to a new user, be sure also to hand over the manual.

## **WARNING**

-  Do not use means to accelerate the defrosting process or to clean, other than those recommended by the manufacturer.
- The appliance must be stored in a room without continuously operating ignition sources (for example: open flames, an operating gas appliance or an operating electric heater).
- Do not pierce or burn.
- Be aware that refrigerants may not contain an odour.
- The appliance must be installed, operated and stored in a room with floor area larger than  $-^*m^2$  for 20/25/35/46 class.  
\* Since the maximum refrigerant charge of the models is below 1.84kg, it does not have any limitation for the minimum floor area. Maintain an installation height of 1.8m or more from the floor surface to the bottom of the appliance.
- To avoid fire, explosion or injury, do not operate the unit when harmful gases (e.g. flammable or corrosive) are detected near the unit.
- Be aware that prolonged, direct exposure to cool or warm air from the air conditioner, or to air that is too cool or too warm, can be harmful to your physical condition and health.
- Do not place objects, including rods, your fingers, etc., in the air inlet or outlet. Product damage or personal injury may result due to contact with the air conditioner's high-speed fan blades.
- Do not attempt to repair, dismantle, reinstall or modify the air conditioner yourself as this may result in water leakage, electric shock or fire hazards.
- Do not use flammable spray near the air conditioner, or otherwise fire may result.
- Do not use a refrigerant other than the one indicated on the outdoor unit (R32) when installing, moving or repairing. Using other refrigerants may cause trouble or damage to the unit, and personal injury.
- To avoid electric shock, do not operate with wet hands.

-  Beware of fire in case of refrigerant leakage. If the air conditioner is not operating correctly, i.e. not generating cool or warm air, refrigerant leakage could be the cause. Consult your dealer for assistance. The refrigerant within the air conditioner is safe and normally does not leak.  
However, in the event of a leakage, contact with a naked burner, heater or cooker may result in generation of noxious gas. Do not use the air conditioner until a qualified service person confirms that the leakage has been repaired.
- Do not attempt to install or repair the air conditioner yourself. Improper workmanship may result in water leakage, electric shock or fire hazards. Please contact your local dealer or qualified personnel for installation and maintenance work.
- If the air conditioner is malfunctioning (giving off a burning odour, etc.), turn off power to the unit and contact your local dealer. Continued operation under such circumstances may result in a failure, electric shock or fire hazards.
- Be sure to install an earth leakage circuit breaker. Failure to install an earth leakage circuit breaker may result in electric shock or fire.

-  Be sure to earth the unit. Do not earth the unit to a utility pipe, lightning conductor or telephone earth lead. Imperfect earthing may result in electric shock.

## **CAUTION**

-  Do not use the air conditioner for purposes other than those for which it is intended. Do not use the air conditioner for cooling precision instruments, food, plants, animals or works of art as this may adversely affect the performance, quality and/or longevity of the object concerned.
- Do not expose plants or animals directly to the airflow from the unit as this may cause adverse effects.
- Do not place appliances that produce naked flames in places exposed to the airflow from the unit as this may impair combustion of the burner.
- Do not block the air inlets nor outlets. Impaired airflow may result in insufficient performance or trouble.

-  Do not sit on the outdoor unit, put things on the unit, or pull the unit. Doing so may cause accidents, such as falling or toppling down, thus resulting in injury, product malfunctioning, or product damage.
- Do not place objects that are susceptible to moisture directly beneath the indoor or outdoor units. Under certain conditions, condensation on the main unit or refrigerant pipes, air filter dirt or drain blockage may cause dripping, resulting in fouling or failure of the object concerned.
- After prolonged use, check the unit stand and its mounts for damage. If they are left in a damaged condition, the unit may fall and cause injury.
- To avoid injury, do not touch the air inlet or aluminium fins of the indoor or outdoor units.
- The appliance is not intended for use by unattended young children or infirm persons. Impairment of bodily functions and harm to health may result.
- Children should be supervised to ensure that they do not play with the unit or its remote controller. Accidental operation by a child may result in impairment of bodily functions and harm health.
- Avoid impacts to the indoor and outdoor units, or otherwise product damage may result.
- Do not place flammable items, such as spray cans, within 1m of the air outlet.  
The spray cans may explode as a result of hot air from the indoor or outdoor units.
- Be careful not to let pets urinate on the air conditioner. Urination on the air conditioner may result in electric shock or fire.
- Do not wash the air conditioner with water, as this may result in electric shock or fire.
- Do not place water containers (vases, etc.) above the unit, as this may result in electric shock or fire hazards if they should topple over.
- Do not insert the batteries in the wrong polarity (+/-) orientation as this may result in short circuiting, fire, or battery leakage.
- Do not sit or hang on the panel. The panel may fall, and injury or product malfunctioning may result.
- Do not sway the panel. The panel may hit people or objects, and injury or property damage may result.
- Do not let children play around the panel. Injury or property damage may result.
- Do not pull the wires. The wires may be broken and the panel may fall, and injury or property damage may result.
- Do not locate obstacles in the route. The panel may fall, and injury or property damage may result.
- Do not bend or damage the wires. The wires may be broken and the panel may fall, and injury or property damage may result.
- Do not put objects on the panel, or otherwise production malfunctioning may result.
- Do not use an unstable stand at the time of operating or maintaining the air conditioner, or otherwise you may topple over or injury yourself.
- Locate the remote controller in places out of reach of children. The wrong operation of the remote controller may result in injury.

-  To avoid oxygen depletion, ensure that the room is adequately ventilated if equipment such as a burner is used together with the air conditioner.
- Before cleaning, be sure to stop unit operation and turn off the circuit breaker. Otherwise, an electric shock and injury may result.
- Only connect the air conditioner to the specified power supply circuit. Power supplies other than the one specified may result in electric shock, overheating and fires.
- Arrange the drain hose to ensure smooth drainage. Imperfect drainage may cause wetting of the building, furniture, etc.
- Do not place objects in direct proximity of the outdoor unit and do not let leaves and other debris accumulate around the unit. Leaves are a hotbed for small animals which can enter the unit. Once inside the unit, such animals can cause malfunctions, smoke or fire if they come into contact with electrical parts.
- Do not place objects around the indoor unit.  
Doing so may have an adverse influence on the performance, product quality, and life of the air conditioner.
- This appliance is not intended to be used by persons with reduced physical, sensory or mental capabilities, or with lack of operation knowledge, unless they have been given supervision or instruction concerning the appliance use by person responsible for their safety. Keep out of children's reach to ensure that they do not play with the appliance.

### Precautions relating to area surrounding the indoor and outdoor units

- Be sure to follow the instructions below.
  - The indoor unit is at least 1m away from any television or radio set (unit may cause interference with the picture or sound).
  - Refrain from using the units in areas prone to high levels of oily smoke, such as a kitchen. Water leakage may result.

# Names of Parts

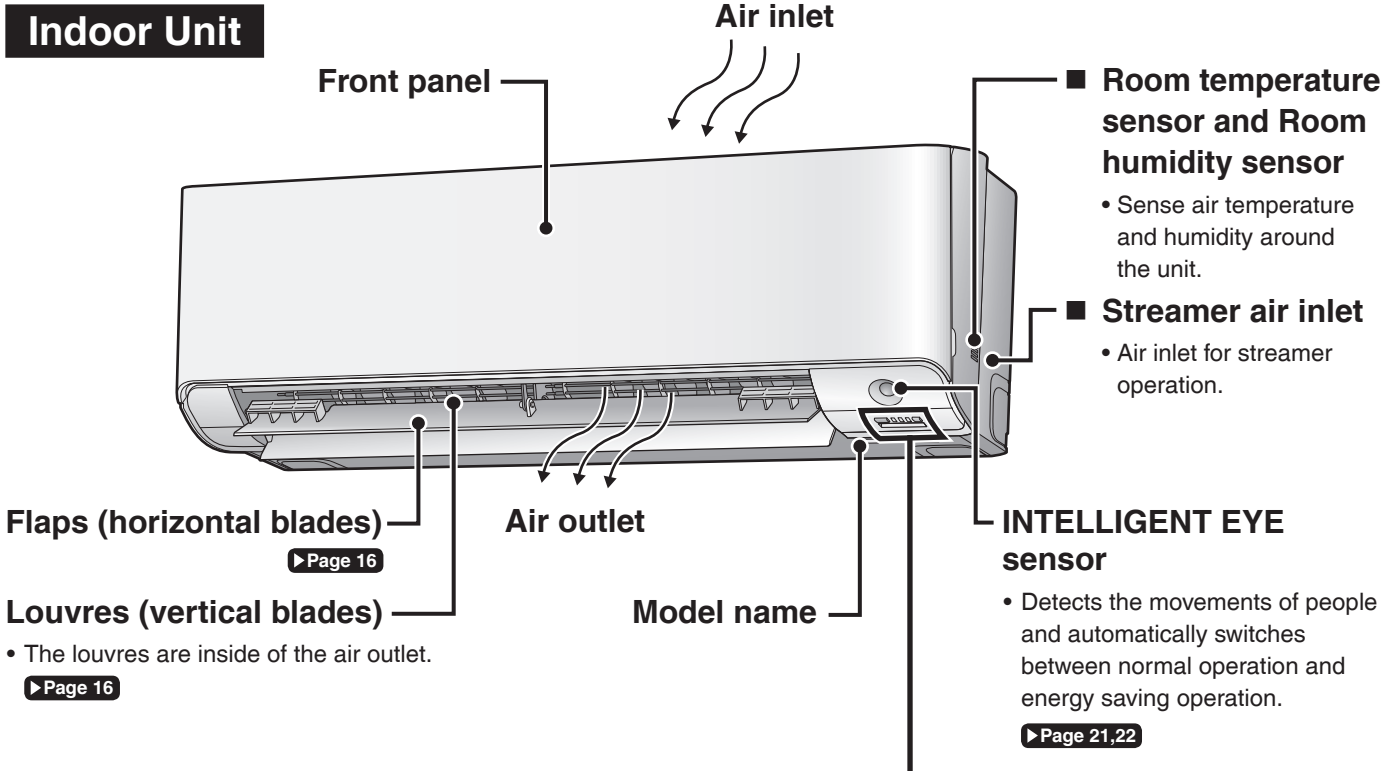

## Display

**MOLD PROOF lamp (Green)**  
▶ Page 17

**TIMER lamp (Orange)**  
▶ Page 25,26,27,30,32

**Indoor unit ON/OFF switch and OPERATION lamp (Green)**

- Press this switch once to start operation. Press once again to stop it.
- For the operation mode setting, refer to the following table.

Model	Mode	Temperature setting	Airflow rate
FTXM20/25/35/46	AUTO	25.0°C	AUTO
FTKM20/25/35/46	COOL	22.0°C	AUTO

This switch can be used when the remote controller is missing or out of batteries.

**STREAMER lamp (Green)**  
▶ Page 19

**Wireless LAN connecting adapter lamp (Orange)**  
▶ Page 34

**Signal receiver**

- It receives signals from the remote controller.
- When the unit receives a signal, you will hear a beep sound.

Case	Sound type
Operation start	beep-beep
Setting change	beep
Operation stop	long beep

### List of lamps

Lamp	Colour	State	Description
OPERATION lamp	green	Lights up	The air conditioner is running.
		Blinks	Check the error code.
TIMER lamp	orange	Lights up	TIMER is set. ▶ Page 25,26,27,30,32
MOLD PROOF lamp	green	Lights up	MOLD PROOF operation. ▶ Page 17
STREAMER lamp	green	Lights up	STREAMER operation. ▶ Page 19
Wireless LAN connecting adapter lamp	orange	Lights up	Wireless LAN connecting adapter operation. ▶ Page 34
		Blinks	Wireless LAN connecting adapter is connected. ▶ Page 34

■ Open the front panel

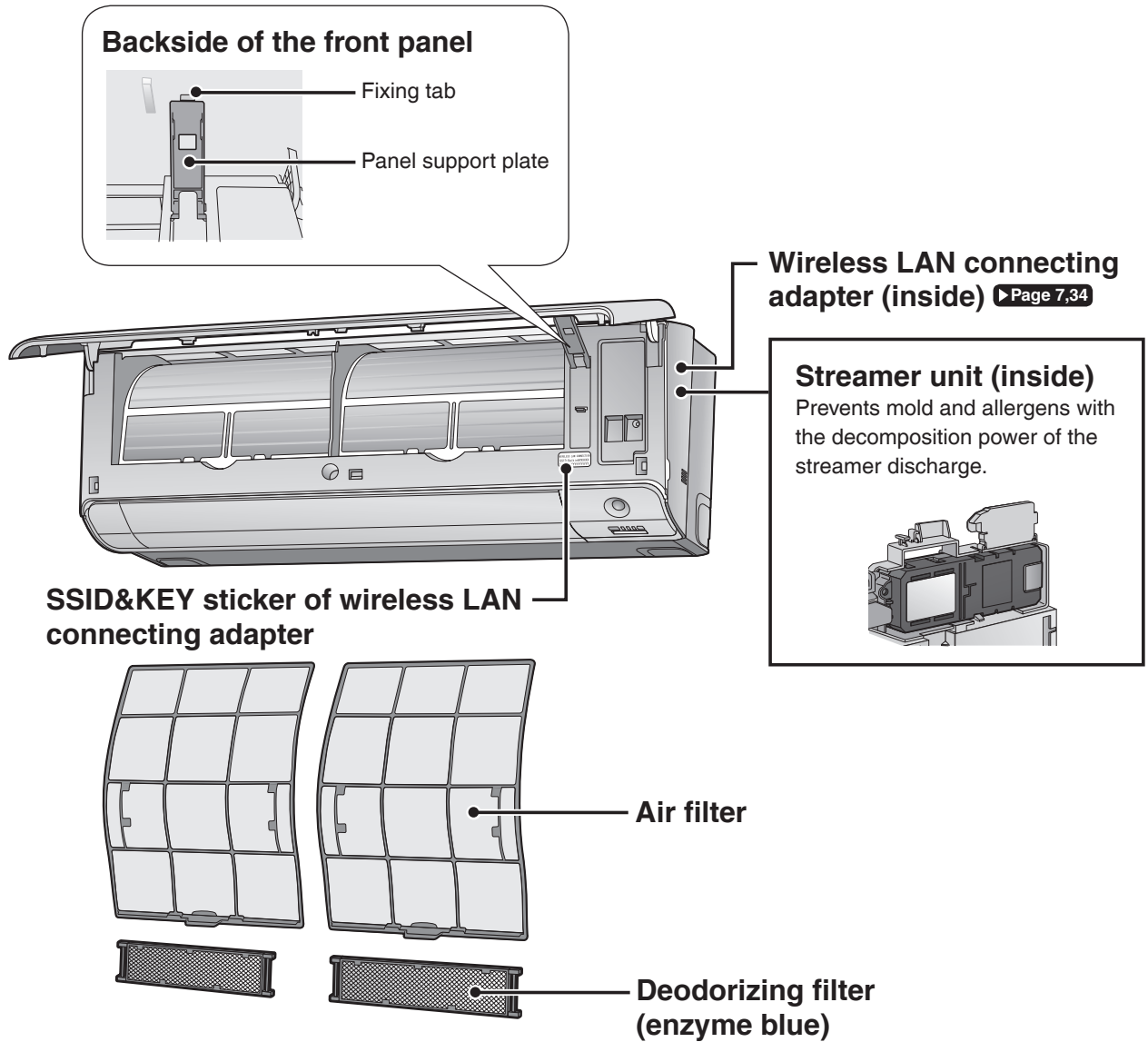

**Outdoor Unit**

• The appearance of the outdoor unit may differ between different models.

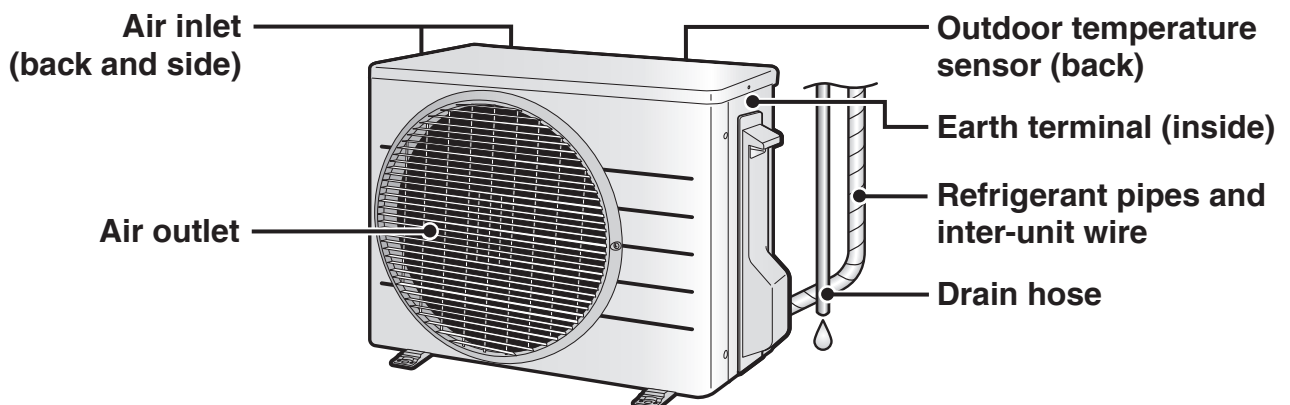

# Names of Parts

## Wireless LAN connecting adapter

The wireless LAN connecting adapter function requires the DAIKIN Mobile Controller application for connecting to the air conditioner and controlling it via your smartphone or tablet over your network.

### ATTENTION

- Attach the sticker to the sticker attachment area on the cover page of the operation manual and keep it safe, as in the detail below:

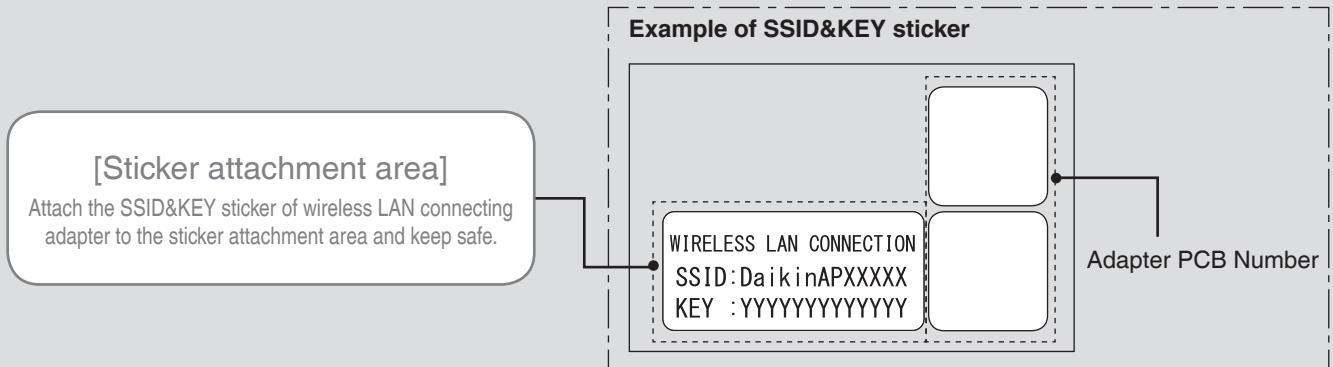

#### [About the SSID and KEY]

- The [SSID] and [KEY] shown on the SSID&KEY sticker are necessary when connecting the air conditioner to a smartphone via wireless LAN.

## Configuration

- The user is responsible for providing the following items before using this product:
  - Smartphone or tablet (Supported OS versions: Android 4.1.2 or higher; iOS 10.0 or higher. For the latest compatibility information, refer to the web site at <http://www.daikintha.com/product/dmobile/compatible> .)
  - Internet line and communicating device (Modem/router or similar device)
  - Wireless LAN access point
  - Application name: [DAIKIN Mobile Controller] (free)  
(application version 4.0 or higher is needed to control this product)  
For details on the installation method for the DAIKIN Mobile Controller application, please see [▶Page 34](#) .

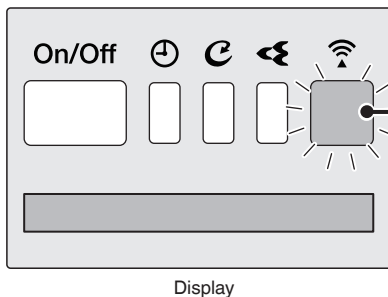

### Wireless LAN connecting adapter lamp (Orange)

- The wireless LAN connecting adapter lamp lights when connecting to a router (Wireless LAN access point). Please see [▶Page 34](#) .
- For wireless LAN connecting adapter operation, please see [▶Page 35](#) .

## NOTE

### Notes on the wireless LAN connecting adapter

- Do not use this product near a microwave oven. (This can affect wireless LAN communications.)
- While the wireless LAN connecting adapter operates, it may affect persons using cardiac pacemakers or defibrillators. This product may cause electromagnetic interference.
- While the wireless LAN connecting adapter operates, it may affect automatic doors or fire alarm equipment. This product may cause faulty behaviour of the equipment.
- For the latest details about installation of the wireless LAN connecting adapter and applicable units, refer to the web site <http://www.daikintha.com/product/dmobile> .



## Remote Controller

### Signal transmitter



Receiver

- To use the remote controller, aim the transmitter at the indoor unit. If there is anything blocking the signals between the unit and the remote controller, such as a curtain, the unit may not operate.
- The maximum transmission distance is about 7m.

### Display (LCD)

- Displays the current settings. (In this illustration, each section is shown with all its displays on for the purpose of explanation.) **(Explained by ARC466A76)**
- For ARC466A77, the display is as follows:

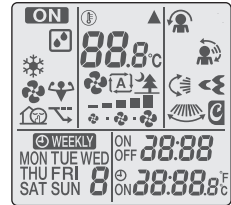

### FAN setting button

- Selects the airflow rate setting. ▶ Page 15

### POWERFUL button and Wireless LAN button

#### POWERFUL button

- POWERFUL operation. ▶ Page 23

#### Wireless LAN button (push 5 seconds)

- Wireless LAN connection. ▶ Page 35

### TEMPERATURE adjustment button

- Changes the temperature setting. ▶ Page 14

### ON/OFF button

- Press this button once to start operation. Press once again to stop it. ▶ Page 13

### Front cover

- Open the front cover. ▶ Page 9

For FTXM20/25/35/46	ARC466A76
For FTKM20/25/35/46	ARC466A77

# Names of Parts

## ■ Open the front cover

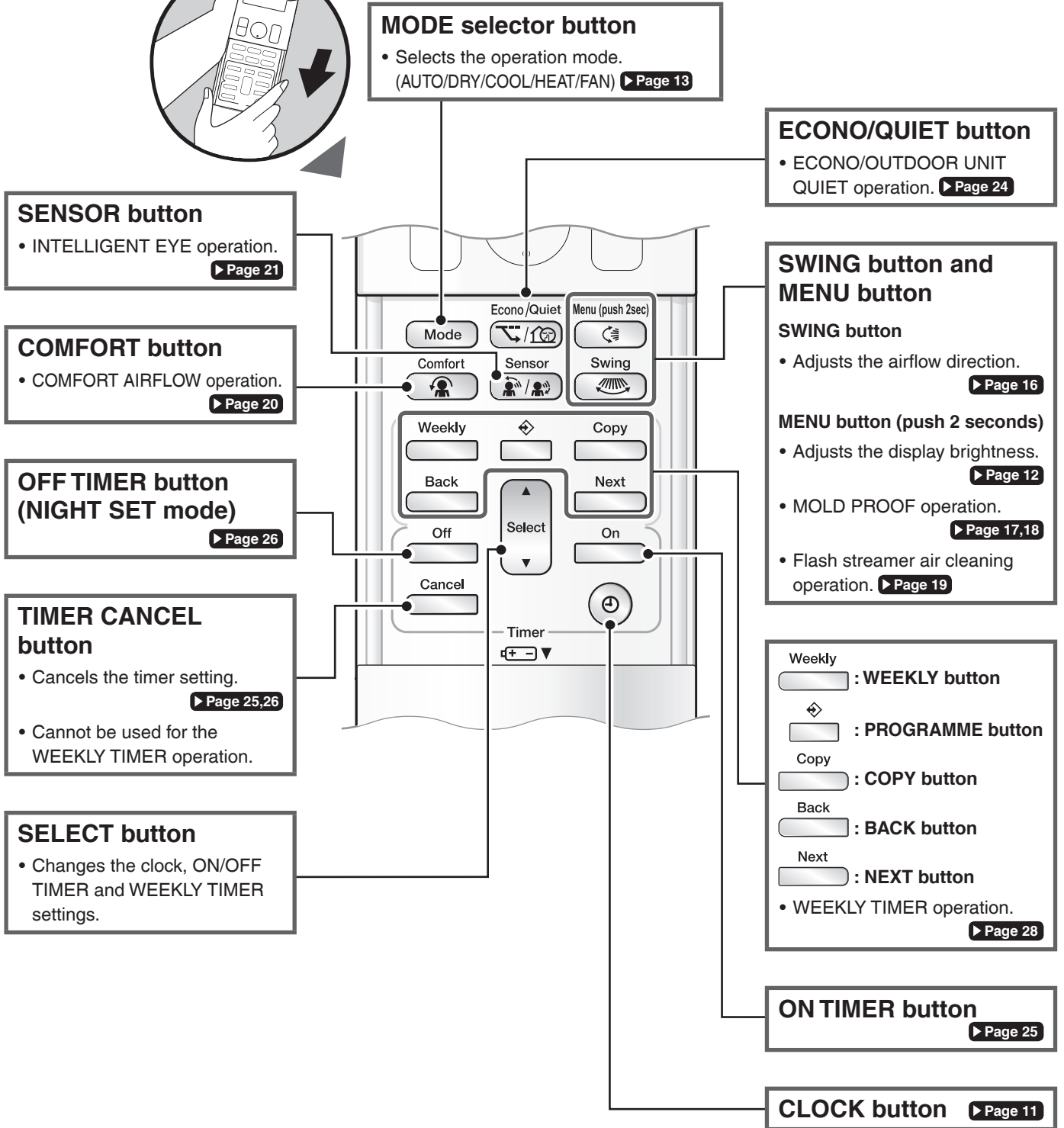
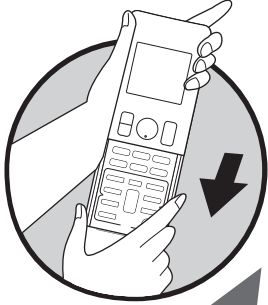

# Preparation Before Operation

## CAUTION

Incorrect handling of batteries can result in injury from battery leakage, rupturing or heating, or lead to equipment failure.

Please observe the following precautions and use safely.

- If the alkaline solution from the batteries should get in the eyes, do not rub the eyes. Instead, immediately flush the eyes with tap water and seek the attention of a medical professional.
- Keep batteries out of reach of children. In the event that batteries are swallowed, seek the immediate attention of a medical professional.
- Do not expose batteries to heat or fire. Do not disassemble or modify batteries. The insulation or gas release vent inside the battery may be damaged, resulting in battery leakage, rupturing, or heating.
- Do not damage or peel off labels on the batteries.

### ■ To insert the batteries

1. Slide the front cover to take it off.
2. Insert 2 dry batteries AAA.LR03 (alkaline).
3. Replace the front cover.

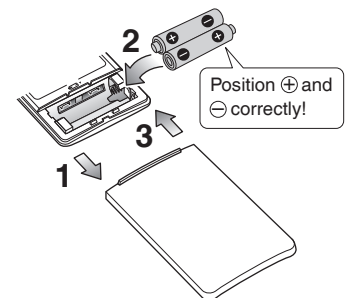

### ■ To fix the remote controller holder to a wall

1. Choose a place from where the signals reach the unit.
2. Fix the holder to a wall, a pillar, or similar location with the screws supplied with the holder.
3. Place the remote controller in the remote controller holder.

### ■ To attach the deodorizing filter (enzyme blue)

- If attaching the separately sold filters, attach them before turning the power on. [▶ Page 40](#)

### ■ Turn on the circuit breaker

- After the power is turned on, the flaps of the indoor unit open and close once to set the reference position.

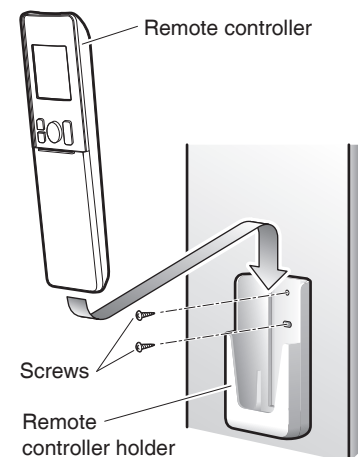

## NOTE

### Notes on batteries

- To avoid possible injury or damage from battery leakage or rupturing, remove the batteries when not using the product for long periods of time.
- The standard replacement time is 1 year. Both batteries should be replaced at the same time. Be sure to replace them with new size AAA.LR03 (alkaline) batteries.
- When battery power has run out, the LCD will begin blinking as an alert that the batteries need replacing. In some cases, when battery consumption is accelerated owing usage conditions, signal reception may decline before the LCD begins blinking.
- The batteries supplied with the remote controller are for initial operation. The batteries may run out in less than 1 year.
- The usable period of the batteries may be short depending on the manufactured date of the air conditioner.

### Notes on remote controller

- Do not drop the remote controller. Do not get it wet.
- Dust on the signal transmitter or receiver will reduce the sensitivity. Wipe off dust with soft cloth.
- Signal communication may be disabled if an electronic-starter-type fluorescent lamp (such as inverter-type lamps) is in the room. Consult the shop if that is the case.
- If the remote controller signals happen to operate another appliance, move that appliance to somewhere else, or consult the service shop.

# Preparation Before Operation

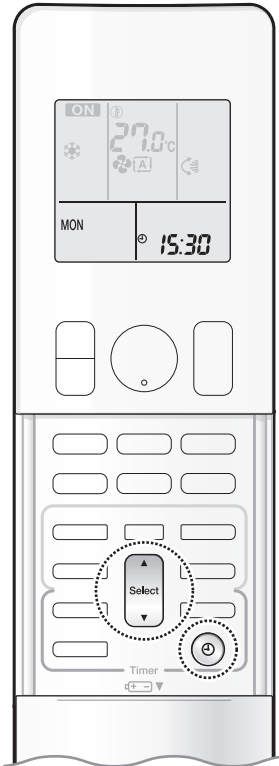

## ■ To set the clock

**1. Press**  .

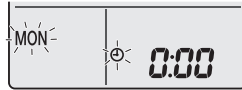

“0:00” appears on the LCD.  
“-MON-” and “☀” blink.

**2. Press**  to set the current day of the week.

Display	Day of the week
MON	Monday
TUE	Tuesday
WED	Wednesday
THU	Thursday
FRI	Friday
SAT	Saturday
SUN	Sunday

**3. Press**  .



“☀” blinks.

**4. Press**  to set the clock to the present time.

- Holding down ▲ or ▼ rapidly increases or decreases the displayed time.

**5. Press**  .

- Point the remote controller at the indoor unit when pressing the button.



“☀” blinks.

## NOTE

### Note on setting the clock

- If the indoor unit's internal clock is not set to the correct time, the ON/OFF TIMER and WEEKLY TIMER will not operate punctually.

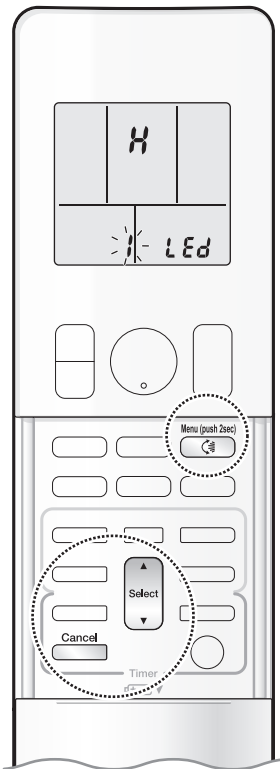

■ **To set the brightness of the indoor unit lamps**

Adjust the brightness of the indoor unit display as desired, or turn OFF the display.

■ **To set**

**1. Press**  **and hold the button for 2 seconds.**

- “LED” appears on the LCD.
- “H” (menu number) blinks.

**2. Press**  **or**  **and select menu number 1.**

**3. Press**  **to confirm the selected setting.**

**4. Press**  **or**  **and select the desired brightness.**

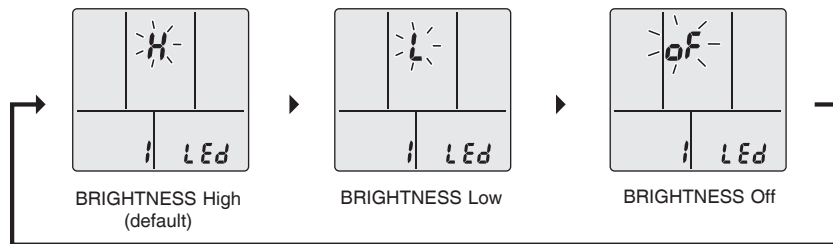

**5. Press**  **again.**

- Brightness will be set to the chosen value.

**6. Press**  **to return to the default screen.**

**NOTE**

**Note on setting brightness of the indoor unit lamps**

- The display automatically returns to the default screen after 60 seconds. To return to the default screen sooner, press  twice.





# AUTO · DRY · COOL · HEAT · FAN Operation

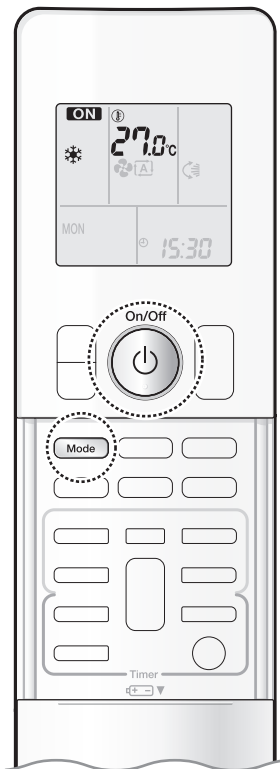

The air conditioner operates with the operation mode of your choice. From the next time on, the air conditioner will operate with the same operation mode.

## ■ To start

### 1. Press and select an operation mode.

- Each pressing of the button changes the mode setting in sequence.

**For FTXM20/25/35/46**

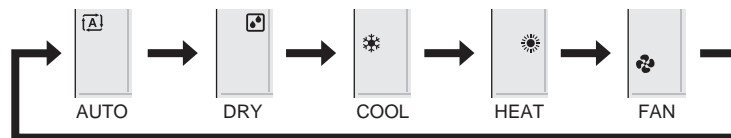

**For FTKM20/25/35/46**

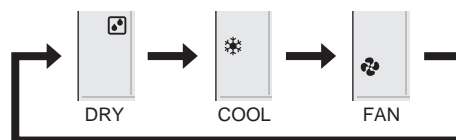

### 2. Press .

- “**ON**” appears on the LCD.
- The OPERATION lamp lights green.

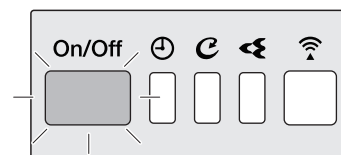

Display

## ■ To stop

### ▶ Press again.

- “**ON**” disappears from the LCD.
- The OPERATION lamp goes off.

## NOTE

### Notes on AUTO operation

- In AUTO operation, the system selects an appropriate operation mode (COOL or HEAT) based on the indoor temperature and starts the operation.
- The system automatically reselects setting at a regular interval to bring the indoor temperature to the user-setting level.

### Note on COOL operation

- This air conditioner cools the room by releasing the heat in the room outside. Therefore, the cooling performance of the air conditioner may be degraded if the outdoor temperature is high.

### Note on DRY operation

- Eliminates humidity while maintaining the indoor temperature as much as possible. It automatically controls temperature and airflow rate, so manual adjustment of these functions is unavailable.

### Notes on HEAT operation

- Since this air conditioner heats the room by taking heat from outdoor air to indoors, the heating capacity becomes smaller in lower outdoor temperatures. If the heating effect is insufficient, it is recommended to use another heating appliance in combination with the air conditioner.
- The heat pump system heats the room by circulating hot air around all parts of the room. After the start of HEAT operation, it takes some time before the room gets warmer.
- In HEAT operation, frost may occur on the outdoor unit and lower the heating capacity. In that case, the system switches into defrosting operation to take away the frost.

### Note on FAN operation

- This mode is valid for fan only.

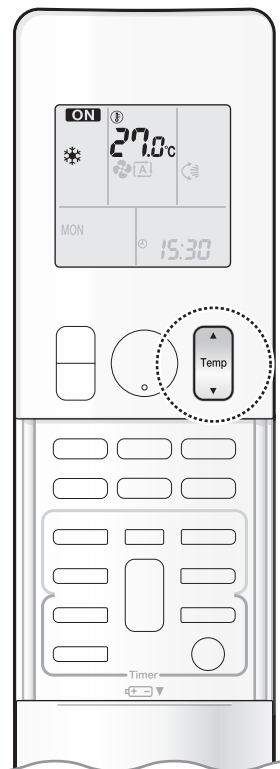

## ■ To change the temperature setting

Press  .

- Press ▲ to raise the temperature and press ▼ to lower the temperature. Each pressing of the button changes the temperature by 0.5°C.

COOL operation	HEAT operation	AUTO operation	DRY/FAN operation
18.0~32.0°C	10.0~30.0°C	18.0~30.0°C	The temperature setting cannot be changed.

## Tips for saving energy

### Keeping the temperature setting at a moderate level helps save energy.

- Recommended temperature setting for cooling: 26.0-28.0°C, for heating: 20.0-24.0°C

### Cover windows with a blind or a curtain.

- Blocking sunlight and air from outdoors increases the cooling (heating) effect.

### Keep the air filters clean.

- Clogged air filters cause inefficient operation and waste energy. Clean them once in about every 2 weeks. [▶ Page 39](#)

### If you are not going to use the air conditioner for a long period, for example in spring or autumn, turn off the circuit breaker.

- The air conditioner always consumes a small amount of electricity even while it is not operating.



# Adjusting the Airflow Rate

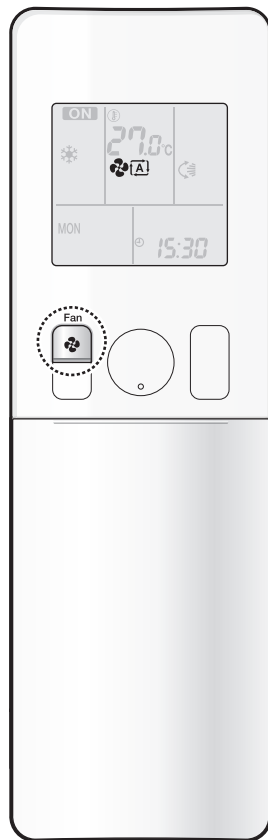



You can adjust the airflow rate to increase your comfort.

## ■ To adjust the airflow rate setting

▶ Press  .

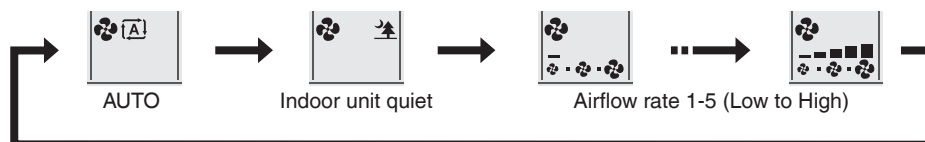
- Each pressing of the button changes the airflow rate setting in sequence.



- When the airflow is set to “”, quiet operation starts and noise from the indoor unit will become quieter.
- In the quiet operation mode, the airflow rate is set to a weak level.
- If the temperature does not reach the desired point, change the airflow rate setting.
- If COOL/DRY operation is started with airflow settings on “AUTO”, the indoor unit will initially deodorise, which functions to suppress any internal odours. As a result, the indoor unit will not emit air immediately. (Wait for about 1 minute.)
- At smaller airflow rates, the cooling (heating) effect is also smaller.



# Adjusting the Airflow Direction

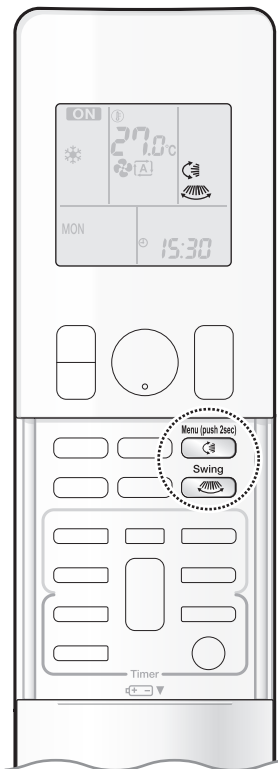

You can adjust the airflow direction to increase your comfort.

## ⚠ CAUTION

- Always use a remote controller to adjust the angles of the flaps and louvres.
  - If you attempt to move the flaps and louvres forcibly by hand when they are swinging, the mechanism may be damaged.
  - Inside the air outlet, a fan is rotating at a high speed.

## ■ To start auto swing

### Up and down airflow direction

▶ Press  .

- “” appears on the LCD.
- The flaps (horizontal blades) will begin to swing.

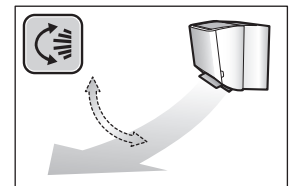

### Right and left airflow direction



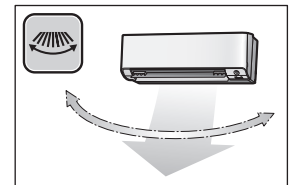

▶ Press  .

- “” appears on the LCD.
- The louvres (vertical blades) will begin to swing.



### The 3-D airflow direction

▶ Press  and  .

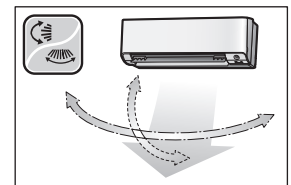

- “” and “” appear on the LCD.
- The flaps and louvres move in turn.
- To cancel 3-D airflow, press either  or  again. The flaps or louvres will stop moving.



## ■ To set the flaps or louvres at the desired position

- This function is effective while the flaps or louvres are in auto swing mode.

▶ Press  and  when the flaps or louvres reach the desired position.

- In the 3-D airflow, the flaps and louvres move in turn.
- “” or “” disappears from the LCD.

## NOTE

### Note on airflow direction setting

- The movable range of the flaps varies according to the operation mode.

### Note on 3-D airflow

- Using 3-D airflow circulates cold air, which tends to collect at the bottom of the room, and hot air, which tends to collect near the ceiling, throughout the room, preventing areas of cold and hot developing.

### Movable range of the flaps

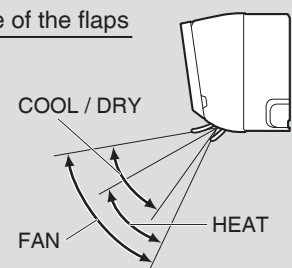

# MOLD PROOF Operation

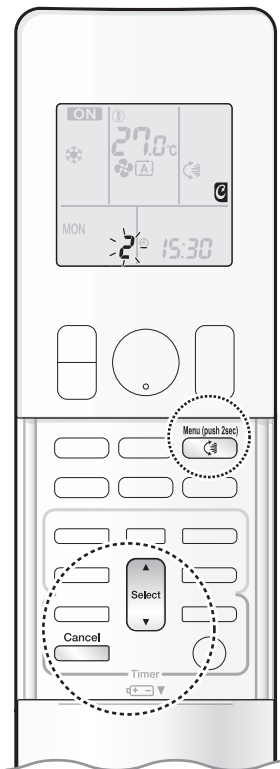



The inside of the air conditioner is dried to reduce the occurrence of mold and odour. When COOL or DRY operation is performed, condensation may occur inside the air conditioner and may cause mold or odour. It is recommended to dry the inside of the air conditioner using MOLD PROOF operation.

## [To operate automatically]

### ■ To set

**1. Press**  **and hold the button for 2 seconds.**

**2. Press**  **or**  **and select menu number 2.**

- “” appears on the LCD.
- “” (menu number) blinks.

**3. Press**  **to confirm the selected setting.**

**4. Press**  **or**  **to change the setting as follows:**

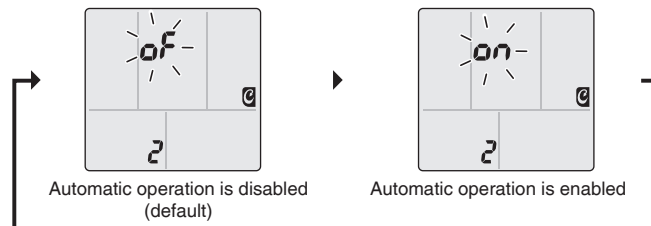

**5. Press**  **again.**

- Automatic MOLD PROOF operation will be enabled or disabled according to the chosen setting.
- If automatic MOLD PROOF operation is enabled, “” appears on the LCD and the MOLD PROOF lamp lights green when MOLD PROOF operation is in progress.
- The STREAMER lamp lights green and flash streamer air cleaning operation starts.

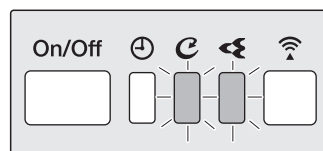

Display

**NOTE** **6. Press**  **to return to the default screen.**

#### Note on MOLD PROOF setting

- The display automatically returns to the default screen after 60 seconds. To return to the default screen sooner, press  twice.

#### Notes on MOLD PROOF operation

- When you want to stop MOLD PROOF operation midway, press  twice.
- After DRY or COOL operation stops, the air conditioner starts MOLD PROOF operation automatically, and then stops automatically 60 minutes later.
- This operation dries the inside of the air conditioner while streamer discharge is performed to reduce the development of mold and odour inside the air conditioner. But the function does not remove any adhered dust and mold.
- MOLD PROOF operation is not available when the unit is turned off using the OFF TIMER or turned off using a smartphone.



## NOTE

### Notes on MOLD PROOF operation

- The flaps may sometimes close to increase the drying effect inside the air conditioner.
- MOLD PROOF operation may not be performed if the COOL or DRY operation time is short.
- If MOLD PROOF operation does not suit your preference, set operation to "OFF". [▶ Page 17](#)

### Relation between MOLD PROOF operation and indoor unit lamps

Air conditioner	MOLD PROOF setting	MOLD PROOF lamp	STREAMER lamp
Operating (OPERATION lamp lights up)	MOLD PROOF is "ON"	Lights up	Depends on STREAMER setting
	MOLD PROOF is "OFF"	Goes off	
Not operating (OPERATION lamp goes off)	MOLD PROOF is "ON"	Lights up	Lights up



# FLASH STREAMER AIR CLEANING operation

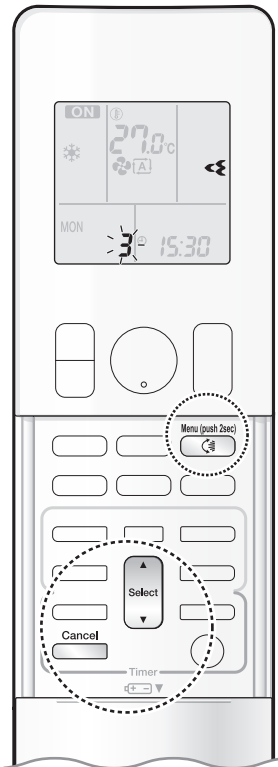

The streamer generates a high-speed electron stream with a high oxidizing power, reducing bad odours and viruses. Together with the deodorizing filter (enzyme blue) and the air filters, this function cleans the air in the room.

## ■ To set

**1. Press**  **and hold the button for 2 seconds.**

**2. Press**  **or**  **and select menu number 3.**

- “☄” appears on the LCD.

- “3” (menu number) blinks.

**3. Press**  **to confirm the selected setting.**

**4. Press**  **or**  **to change the setting as follows:**

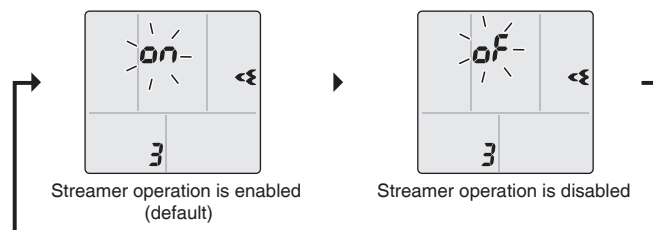

**5. Press**  **again.**

- Flash streamer air cleaning will be enabled or disabled according to the chosen setting.

- If STREAMER operation is enabled, “☄” appears on the LCD.

The STREAMER lamp lights green and flash streamer air cleaning operation starts.

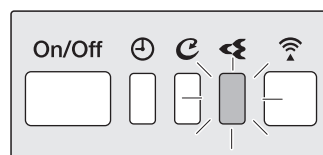

Display

**6. Press**  **to return to the default screen.**

## NOTE

### What is streamer discharge?

- This is a type of plasma discharge comprising high-speed electrons with a high oxidative capacity that is released within the unit. It decomposes odours and harmful gases. (The high-speed electrons are generated and then adsorbed within the unit ensure your safety.)

### Note on flash streamer air cleaning setting

- The display automatically returns to the default screen after 60 seconds. To return to the default screen sooner, press  twice.

### Notes on flash streamer air cleaning operation

- The streamer discharge may generate a fizzing sound, however this does not indicate a defect.
- Do not block the air inlets of the streamer with any objects (Fig.1). Impaired airflow may result in insufficient performance or trouble with streamer operation.

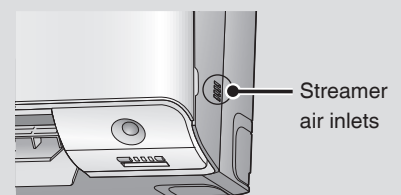
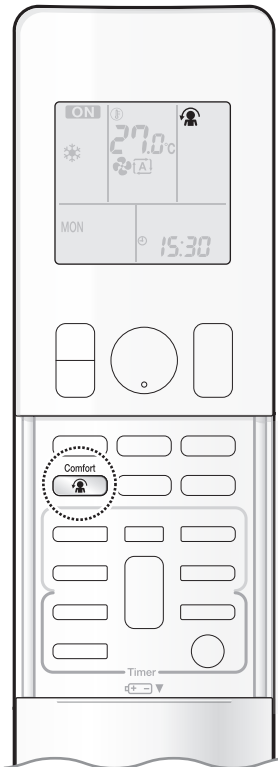

Fig. 1



# COMFORT AIRFLOW Operation



The flow of air will be in the upward direction while in COOL/DRY operation and in the downward direction while in HEAT operation, which will provide a comfortable wind that will not come in direct contact with people.

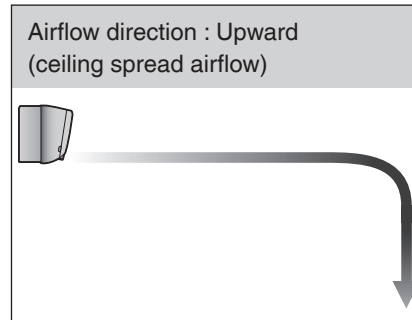

COOL and DRY operation

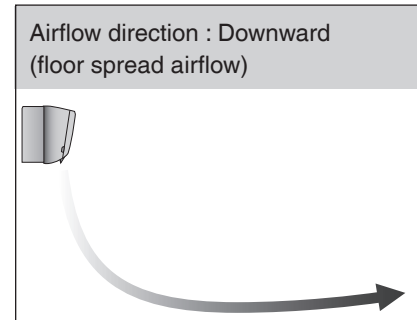

HEAT operation

## ■ To start

Press **Comfort** .

- “” appears on the LCD.

	COOL and DRY operation	HEAT operation	FAN operation
Flaps direction	Goes up	Goes down	Not available
Airflow rate	AUTO		

## ■ To cancel

Press **Comfort**  again.

- “” disappears from the LCD.
- The flaps will return to the position in memory from before COMFORT AIRFLOW operation.

## NOTE

### Notes on COMFORT AIRFLOW Operation

- POWERFUL operation and COMFORT AIRFLOW operation cannot be used at the same time.
- The airflow rate will be set to AUTO.
- If the upward and downward airflow direction is selected, the COMFORT AIRFLOW function will be canceled. Priority is given to the function of whichever button is pressed last.
- If there is an obstruction under the air conditioner when using heating, the airflow may not reach the center of the room and the room may be difficult to warm up.



# INTELLIGENT EYE Operation

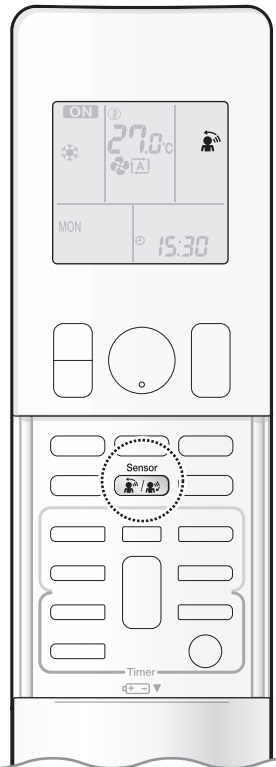

The INTELLIGENT EYE sensor detects human movement and adjusts airflow direction. It can be set to avoid people or to direct airflow specifically at people. If no one is in the room for more than 20 minutes, the operation automatically changes to energy saving operation.

## ⚠ CAUTION



- Do not place large objects near the INTELLIGENT EYE sensor. Also keep heating units and humidifiers outside the sensor's detection area. This sensor can detect undesirable objects.
- Do not hit or violently push the INTELLIGENT EYE sensor. This can lead to damage and malfunction.

## ■ To start

▶ Press  and select the desired mode.

- Each time  is pressed, a different setting option appears on the LCD.



- If both INTELLIGENT EYE operation and auto swing airflow directions (up and down or right and left) are set simultaneously, priority is given to auto swing airflow directions and INTELLIGENT EYE operation will be operated in energy saving operation only. (“” or “” will remain on the LCD.) To keep INTELLIGENT EYE operation active, do not use it in combination with auto swing airflow direction modes.

## ■ To cancel

▶ Press  until no icon is displayed.

## NOTE





### Notes on combining INTELLIGENT EYE operation and COMFORT AIRFLOW operation

- INTELLIGENT EYE operation can operate in combination with COMFORT AIRFLOW operation.
  - When the INTELLIGENT EYE operation is set to blow directly on people and COMFORT AIRFLOW operation is activated simultaneously, the air conditioner tracks you horizontally, without the air blowing directly on you.
- The airflow rate will be set to AUTO. If the up and down airflow direction is selected, the COMFORT AIRFLOW operation will be canceled. Priority is given to the function of whichever button is pressed last.

## ■ How INTELLIGENT EYE operation works

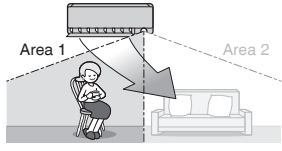
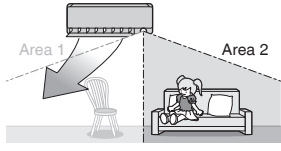
The INTELLIGENT EYE sensor detects human movement and adjusts the right and left airflow direction. If no one is in the room for more than 20 minutes, the operation automatically changes to energy saving operation. The INTELLIGENT EYE sensor works differently depending on the situation.

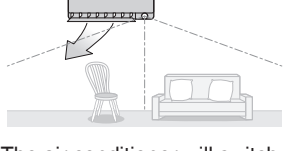
[Example]

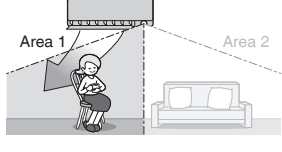
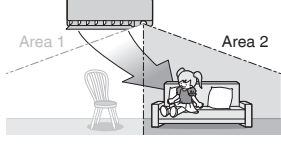
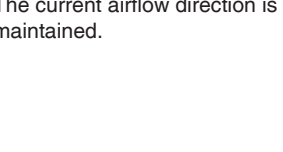
	A person is detected in area 1.	A person is detected in area 2.	People are detected in both areas.	No people are detected in the areas.
				
				<p>The air conditioner will switch to energy-saving mode after 20 minutes.</p>

\* The airflow direction may differ from the illustrated direction depending on the actions and movements of the people in the areas.

## INTELLIGENT EYE operation is useful for energy saving

### Energy saving operation

- If no presence detected in the room for 20 minutes, the energy saving operation will start.
- This operation changes the temperature by  $-2^{\circ}\text{C}$  in HEAT /  $+2^{\circ}\text{C}$  in COOL /  $+2^{\circ}\text{C}$  in DRY operation from the set temperature. When the room temperature exceeds  $30^{\circ}\text{C}$ , the operation changes the temperature by  $+1^{\circ}\text{C}$  in COOL /  $+1^{\circ}\text{C}$  in DRY operation from the set temperature.
- This operation decreases the airflow rate slightly in FAN operation only.

## NOTE

### Notes on INTELLIGENT EYE operation

- Application range is as follows.

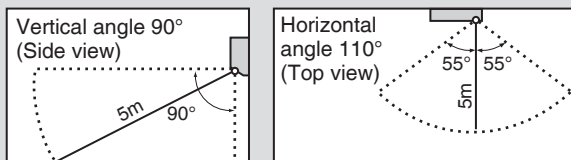

- While the air conditioner is in INTELLIGENT EYE operation, the louvres adjust the airflow direction if there are people in the sensing areas of the INTELLIGENT EYE so that the leftward or rightward airflow will not be directed to the people. If no people are detected in either area 1 or 2 for 20 minutes, the air conditioner switches to the energy-saving mode with the set temperature shifted by  $2^{\circ}\text{C}$ . The air conditioner may switch to the energy-saving operation even if there are people in the areas. This may occur depending on the clothes the people are wearing, if there is no movement of the people in the areas.
- The airflow direction from the louvres will be leftward if there are people in both areas 1 and 2. The air will also flow left if there is a person right in front of the sensor as the sensor judges that there are people in both areas.
- Due to the position of the sensor, people might be exposed to the airflow of the indoor unit if they are close to the front side of the indoor unit. If there are people close to the front side of the indoor unit or in both areas, it is recommended to use the COMFORT AIRFLOW and INTELLIGENT EYE operations simultaneously. Using both modes together, the air conditioner will not direct the airflow towards the people.
- The sensor may not detect moving objects further than 5m away. (Please see the application range)
- Sensor detection sensitivity changes according to the indoor unit location, the speed of passers-by, temperature range, etc.
- The sensor could also mistakenly detect pets, sunlight, fluttering curtains and light reflected off of mirrors as passers-by.
- NIGHT SET mode  Page 26 will not switch on during use of INTELLIGENT EYE operation.





# POWERFUL Operation

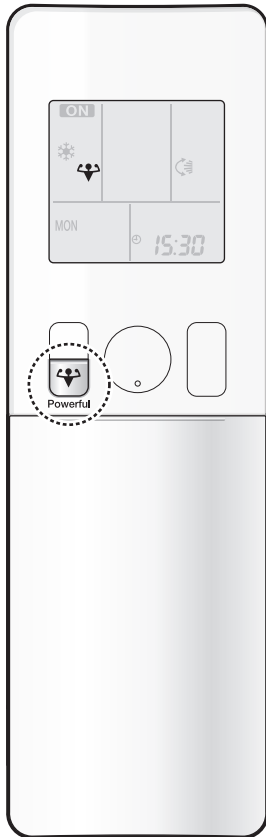

POWERFUL operation quickly maximises the cooling (heating) effect in any operation mode. In this mode, the air conditioner operates at maximum capacity.

## ■ To start

▶ Press  during operation.

- “” appears on the LCD.
- POWERFUL operation ends in 20 minutes. Then the system automatically operates again with the previous settings which were used before POWERFUL operation.



## ■ To cancel

▶ Press  again.

- “” disappears from the LCD.

## NOTE

### Notes on POWERFUL operation

- Pressing  causes the settings to be cancelled, and “” disappears from the LCD.
- POWERFUL operation will not increase the capacity of the air conditioner if the air conditioner is already in operation with its maximum capacity demonstrated.
  - **In COOL, HEAT and AUTO operation**  
To maximise the cooling (heating) effect, the capacity of outdoor unit increases and the airflow rate becomes fixed at the maximum setting. The temperature and airflow settings cannot be changed.
  - **In DRY operation**  
The temperature setting is lowered by 2.5°C and the airflow rate is slightly increased.
  - **In FAN operation**  
The airflow rate is fixed at the maximum setting.

### Regarding the combination of POWERFUL and other operations

POWERFUL + COMFORT AIRFLOW	
POWERFUL + ECONO	Not available*
POWERFUL + OUTDOOR UNIT QUIET	

\*Priority is given to the function of whichever button is pressed last.



# ECONO / OUTDOOR UNIT QUIET Operation

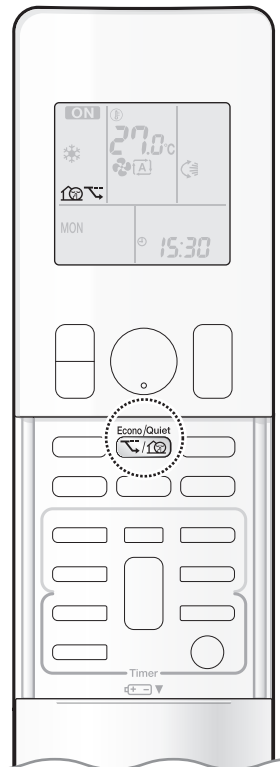

ECONO operation enables efficient operation by limiting the maximum power consumption. This function is useful to prevent the circuit breaker from tripping when the unit operates alongside other appliances on the same circuit.

OUTDOOR UNIT QUIET operation lowers the noise level of the outdoor unit by changing the frequency and fan speed of the outdoor unit. This function is convenient during the night-time operation.

## ■ To start

▶ Press  and select the desired mode.

- Each time  is pressed, a different setting option appears on the LCD.





## ■ To cancel

▶ Press  until no icon is displayed.

## NOTE

### Notes on ECONO operation

- This operation is performed with lower power and therefore may not provide a sufficient cooling (heating) effect.
- Pressing  causes the settings to be cancelled, and “” disappears from the LCD.
- If the power consumption level is already low, switching to ECONO operation will not reduce the power consumption.

### Notes on OUTDOOR UNIT QUIET operation

- Even if the operation is stopped by using the remote controller or the indoor unit ON/OFF switch when using OUTDOOR UNIT QUIET operation, “” will remain displayed on the remote controller.
- OUTDOOR UNIT QUIET operation will not reduce the frequency nor fan speed if they already are operating at reduced levels.
- This operation is performed with lower power and therefore may not provide a sufficient cooling (heating) effect.

### Possible combinations of ECONO / OUTDOOR UNIT QUIET operation and basic operations

	Operation mode				
	AUTO	DRY	COOL	HEAT	FAN
ECONO	✓	✓	✓	✓	—
OUTDOOR UNIT QUIET	✓	—	✓	✓	—



# ON/OFF TIMER Operation

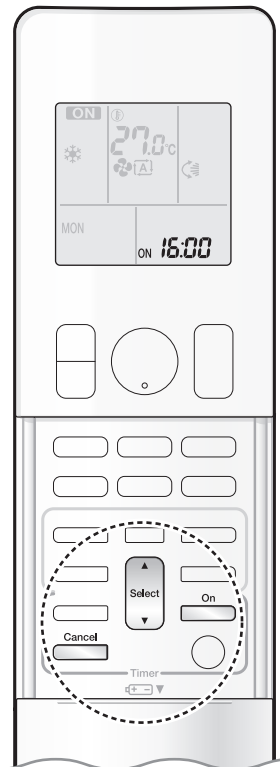

Timer functions are useful for automatically switching the air conditioner on or off at night or in the morning. You can also use the ON TIMER and OFF TIMER together.

## [ON TIMER with a 24 hour clock display] (24 HOUR ON/OFF TIMER)

### ■ To set

- Check that the clock is correct.  
If not, set the clock to the present time. [▶Page 11](#)

**1. Press** .



“6:00” appears on the LCD.  
“ON” blinks.

- “⌚” and day of the week disappear from the LCD.

**2. Press** **until the time setting reaches the point you like.**

- Each pressing of either button increases or decreases the time setting by 10 minutes. Holding down either button changes the setting rapidly.

**3. Press** **again.**

- “ON” and setting time appear on the LCD.
- The TIMER lamp lights orange.

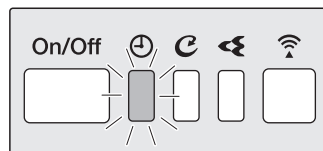

Display

### ■ To cancel

**▶ Press** .

- “ON” and setting time disappear from the LCD.
- “⌚” and day of the week appear on the LCD.
- The TIMER lamp goes off.

## NOTE

### Note on TIMER operation

- When TIMER is set, the present time is not displayed.

### In the following cases, set the timer again.

- After the circuit breaker has turned off.
- After a power failure.
- After replacing the batteries in the remote controller.

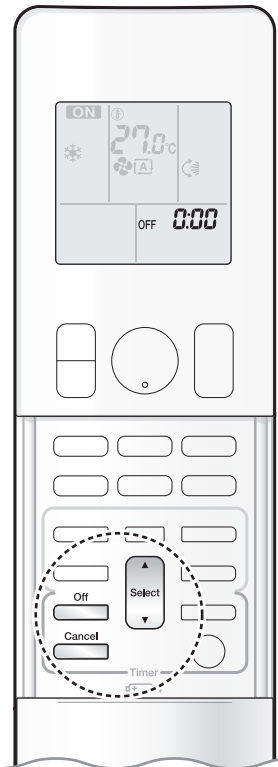

## [OFF TIMER with a 24 hour clock display] (24 HOUR ON/OFF TIMER)

### ■ To set

- Check that the clock is correct.  
If not, set the clock to the present time. ▶Page 11

#### 1. Press .

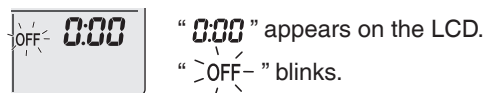

- “ ☉ ” and day of the week disappear from the LCD.

#### 2. Press until the time setting reaches the point you like.

- Each pressing of either button increases or decreases the time setting by 10 minutes. Holding down either button changes the time setting rapidly.

#### 3. Press again.

- “ OFF ” and setting time appear on the LCD.
- The TIMER lamp lights orange.

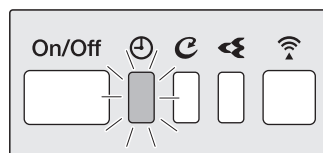

Display

### ■ To cancel

#### ▶ Press .

- “ OFF ” and setting time disappear from the LCD.
- “ ☉ ” and day of the week appear on the LCD.
- The TIMER lamp goes off.

## [ON/OFF TIMER combination]

### ■ To combine

- A sample setting for combining the 2 timers is shown below.

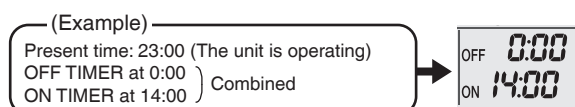

## NOTE

### NIGHT SET mode

- When the OFF TIMER is set, the air conditioner automatically adjusts the temperature setting (0.5°C up in COOL, 2.0°C down in HEAT) to prevent excessive cooling (heating) during sleeping hours.



# ON/OFF TIMER Operation

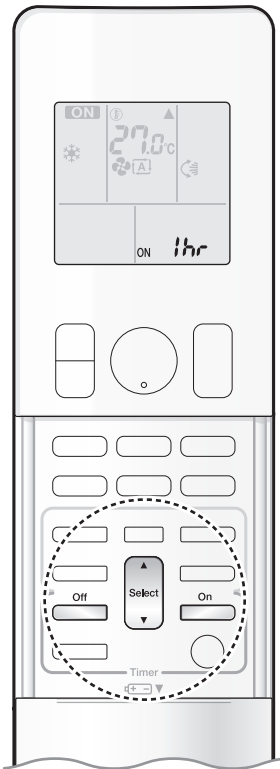

## [ON/OFF TIMER with an hours remaining display] (COUNT UP-DOWN ON/OFF TIMER)

- Check that the clock is correct. If not, set the clock to the present time. **▶Page 11**

**1. Press and hold  or  for about 5 seconds, when signal indicator (▲) blink, release your finger from the button.**

	For ON TIMER "1hr" appears on the LCD. "ON-" blinks.
	For OFF TIMER "1hr" appears on the LCD. "OFF-" blinks.

- "⌚" and day of the week disappear from the LCD.

**2. Press  until the time setting reaches the point you like.**

- Each pressing of the button increases or decreases the time setting by 1 hour.
- The time can be set between 1 and 12 hours.

**3. Press  or  again.**

- "ON" and "OFF", and setting time appear on the LCD.
- The TIMER lamp lights orange.
- To change the display mode from COUNT UP-DOWN ON/OFF TIMER to 24 HOUR ON/OFF TIMER, repeat **STEP 1**, and continue from **STEP 2** of "24 HOUR ON/OFF TIMER". **▶Page 25, 26**
- Timer display mode cannot be changed while "ON-" or "OFF-" are blinking. Press  or  to stop the blinking.

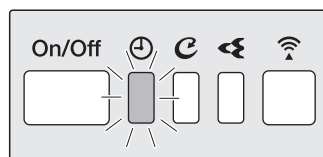

Display

## ■ Combining display modes

- Different display modes (24 HOUR ON/OFF TIMER and COUNT UP-DOWN ON/OFF TIMER) can be used for the ON TIMER and OFF TIMER simultaneously.

(Example)

Present time: 22:00 (The unit is operating) OFF T MER at 1:00 (3 hours after present time) ON T MER at 6:00 (8 hours after present time)	→	OFF 3hr ON 6:00	OFF 1:00 ON 8hr	OFF 3hr ON 8hr
--	---	--------------------	--------------------	-------------------

## NOTE

### Note on COUNT UP-DOWN ON/OFF TIMER

- After setting, the time displayed on the LCD will automatically count down by 1 hour for every 1 hour that passes.  
For example, if the OFF TIMER is set to 3 hours, the display will change as follows: 3hr → 2hr → 1hr → blank (OFF)

### Switching between ON/OFF TIMER display modes (24 hour clock and hours remaining display)

- When changing timer display modes (from 24 HOUR ON/OFF TIMER to COUNT UP-DOWN ON/OFF TIMER or vice versa), the timer cancels. The timer must be set again to activate it.



# WEEKLY TIMER Operation

Up to 4 timer settings can be saved for each day of the week. This is convenient to adapt the WEEKLY TIMER to your family's life style.

## ■ Setting example of the WEEKLY TIMER

The same timer settings are used from Monday through Friday, while different timer settings are used for the weekend.

<p><b>[Monday]</b></p>	<p>Make timer settings for programmes 1-4. ▶ <b>Page 29</b></p> <p><b>Programme 1</b>      <b>Programme 2</b>      <b>Programme 3</b>      <b>Programme 4</b></p> <p>ON                      OFF                      ON                      OFF</p>
<p><b>[Tuesday to Friday]</b></p>	<p>Use the copy mode to make settings for Tuesday to Friday, because these settings are the same as those for Monday. ▶ <b>Page 31</b></p> <p><b>Programme 1</b>      <b>Programme 2</b>      <b>Programme 3</b>      <b>Programme 4</b></p> <p>ON                      OFF                      ON                      OFF</p>
<p><b>[Saturday]</b></p>	<p>No timer settings</p>
<p><b>[Sunday]</b></p>	<p>Make timer settings for programmes 1-4. ▶ <b>Page 29</b></p> <p><b>Programme 1</b>      <b>Programme 2</b>      <b>Programme 3</b>      <b>Programme 4</b></p> <p>ON                      OFF                      OFF                      ON</p>

- Up to 4 reservations per day and 28 reservations per week can be set using the WEEKLY TIMER. The effective use of the copy mode simplifies timer programming.
- The use of ON-ON-ON-ON settings, for example, makes it possible to schedule operating mode and set temperature changes. Furthermore, by using OFF-OFF-OFF-OFF settings, only the turn off time of each day can be set. This will turn off the air conditioner automatically if you forget to turn it off.



# WEEKLY TIMER Operation

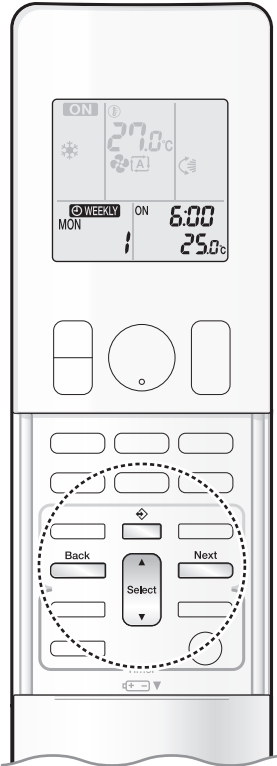

## ■ To use WEEKLY TIMER operation

### Setting mode

- Make sure the day of the week and time are set.  
If not, set the day of the week and time. ▶Page 11

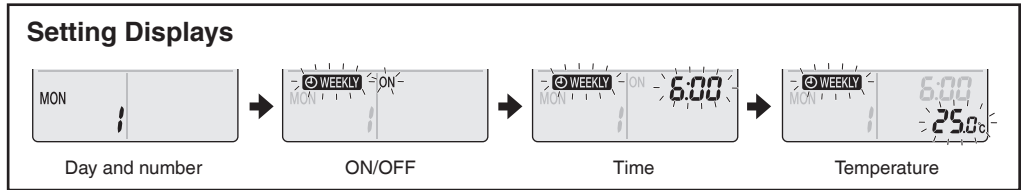
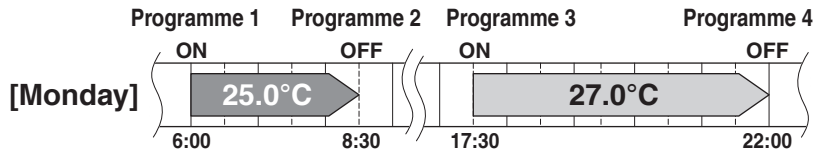

### 1. Press .

- The day of the week and the reservation number of the current day will be displayed.
- 1 to 4 settings can be made per day.

### 2. Press to select the desired day of the week and reservation number.

- Pressing changes the reservation number and the day of the week.

### 3. Press .

- The day of the week and reservation number will be set.
- “ ” and “ ” blink.

### 4. Press to select the desired mode.

- Pressing changes the “ ON ” or “ OFF ” setting in sequence.



- In case the reservation has already been set, selecting “ blank ” deletes the reservation.
- Proceed to **STEP 9** if “ blank ” is selected.
- To return to the day of the week and reservation number setting, press .

### 5. Press .

- The ON/OFF TIMER mode will be set.
- “ ” and the time blink.



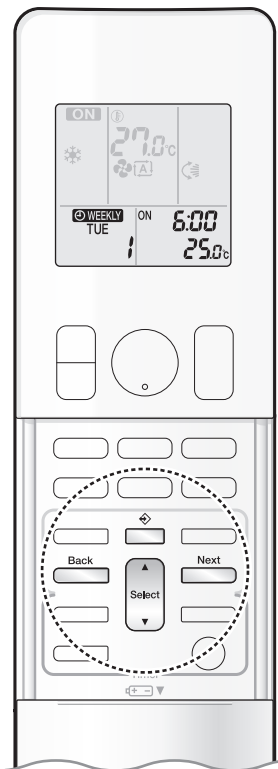





## 6. Press to select the desired time.

- The time can be set between 0:00 and 23:50 in 10-minute intervals.
- To return to the ON/OFF TIMER mode setting, press .
- Proceed to **STEP 9** when setting the OFF TIMER.

## 7. Press .

- The time will be set.
- “ WEEKLY” and the temperature blink.

## 8. Press to select the desired temperature.

- The temperature can be set between 10.0°C and 32.0°C.  
COOL or AUTO: The unit operates at 18.0°C even if it is set to 10.0°C to 17.0°C.  **Page 14**  
HEAT or AUTO: The unit operates at 30.0°C even if it is set to 31.0°C to 32.0°C.  **Page 14**
- To return to the time setting, press .
- The set temperature is only displayed when the mode setting is on.

## 9. Press .

- The temperature will be set and go to the next reservation setting.
- The temperature is set while in ON TIMER operation, and the time is set while in OFF TIMER operation.
- The next reservation screen will appear.
- To continue further settings, repeat the procedure from **STEP 4**.

## 10. Press to complete the setting.

- Be sure to direct the remote controller toward the indoor unit and check for a receiving tone and blinking of the OPERATION lamp.
- “ WEEKLY” appears on the LCD and WEEKLY TIMER operation is activated.
- The TIMER lamp lights orange.

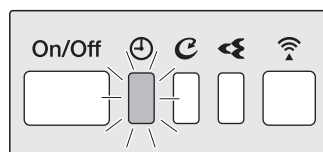





Display

- A reservation made once can be easily copied and the same settings used for another day of the week. Refer to **Copy mode**.  **Page 31**

## NOTE

### Notes on WEEKLY TIMER operation

- Do not forget to set the clock on the remote controller first.  **Page 11**
- The day of the week, ON/OFF TIMER mode, time and set temperature (only for ON TIMER mode) can be set with the WEEKLY TIMER. Other settings for the ON TIMER are based on the settings just before the operation.
- WEEKLY TIMER and ON/OFF TIMER operation cannot be used at the same time. The ON/OFF TIMER operation has priority if it is set while WEEKLY TIMER is still active. The WEEKLY TIMER will enter the standby state, and “ WEEKLY” will disappear from the LCD. When the ON/OFF TIMER is up, the WEEKLY TIMER will automatically become active.
- Only the time and set temperature with the WEEKLY TIMER are sent with the . Set the WEEKLY TIMER only after setting the operation mode, the airflow rate and the airflow direction ahead of time.
- Turning off the circuit breaker, power failure, and other similar events will render operation of the indoor unit's internal clock inaccurate. Reset the clock.  **Page 11**
-  can be used only for the time and temperature settings. It cannot be used to go back to the reservation number.



# WEEKLY TIMER Operation

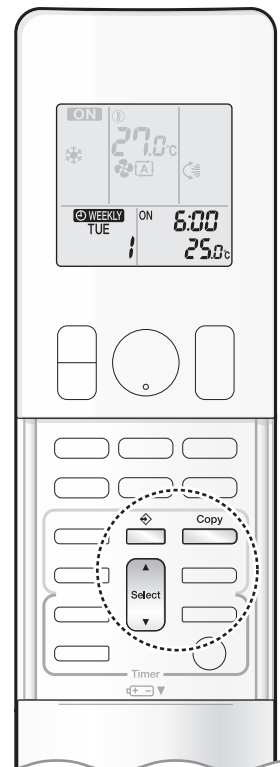

## Copy mode

- A reservation made once can be copied to another day of the week. The whole reservation of the selected day of the week will be copied.

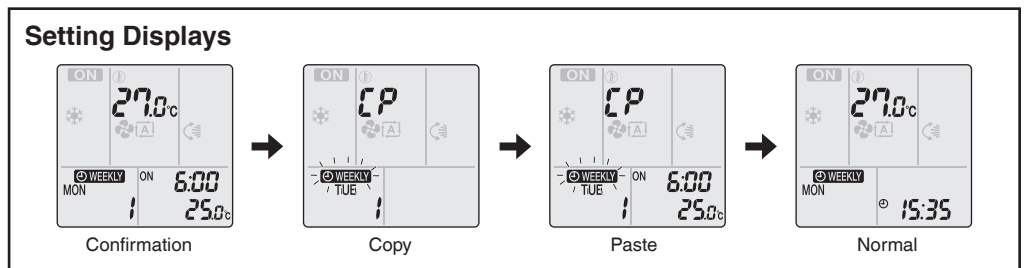
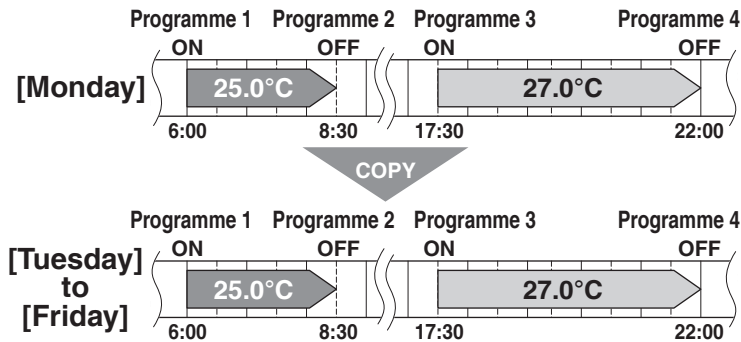

1. Press .
2. Press to confirm the day of the week to be copied.
3. Press .
  - The whole reservation of the selected day of the week will be copied.
4. Press to select the destination day of the week.
5. Press .
  - The reservation will be copied to the selected day of the week. The whole reservation of the selected day of the week will be copied.
  - To continue copying the settings to other days of the week, repeat **STEP 4** and **STEP 5**.
6. Press to complete the setting.
  - “ WEEKLY” appears on the LCD and WEEKLY TIMER operation is activated.

## NOTE

### Note on COPY MODE

- The entire reservation of the source day of the week is copied in the copy mode.
- In the case of making a reservation change for any day of the week individually after copying the content of weekly reservations, press and change the settings in the steps of **Setting mode** . [▶Page 29](#)

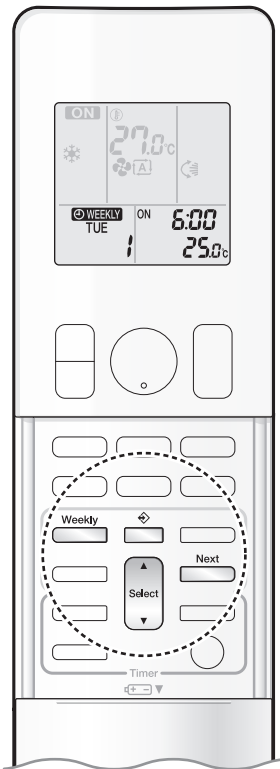

## ■ Confirming a reservation

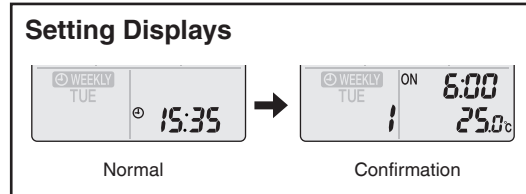

- The reservation can be confirmed.



### 1. Press .

- The day of the week and the reservation number of the current day will be displayed.

### 2. Press to select the day of the week and the reservation number to be confirmed.

- Pressing  displays the reservation details.
- To change the confirmed reserved settings, select the reservation number and press  . The mode is switched to setting mode. Proceed to **Setting mode STEP 4.** [▶Page 29](#)

### 3. Press to exit the confirmation mode.

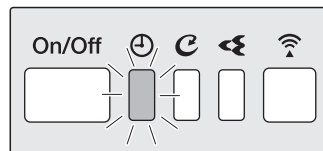

- “  ” appears on the LCD and WEEKLY TIMER operation is activated.
- The TIMER lamp lights orange.



Display

## ■ To deactivate WEEKLY TIMER operation

### ▶ Press while “ ” is displayed on the LCD.

- “  ” disappears from the LCD.
- The TIMER lamp goes off.
- To reactivate the WEEKLY TIMER operation, press  again.
- If a reservation deactivated with  is activated once again, the last reservation mode will be used.

## NOTE

- If not all the reservation settings are reflected, deactivate the WEEKLY TIMER operation once. Then press  again to reactivate the WEEKLY TIMER operation.



# WEEKLY TIMER Operation

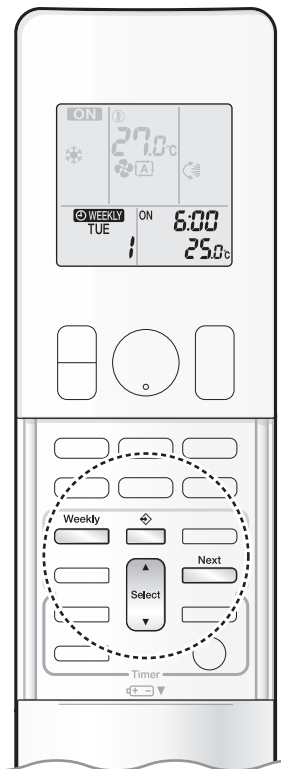

## ■ To delete a reservation

### An individual reservation

**1. Press** .

- The day of the week and the reservation number will be displayed.

**2. Press** **to select the day of the week and the reservation number to be deleted.**

**3. Press** .

- “ WEEKLY-” and “ ON-” or “ OFF-” blink.

**4. Press** **until no icon is displayed.**

- Pressing changes the ON/OFF TIMER mode in sequence.
- Selecting “blank” will cancel any reservation you may have.



**5. Press** .

- The selected reservation will be deleted.

**6. Press** .

- If there are still other reservations, WEEKLY TIMER operation will be activated.

### Reservations for each day of the week

- This function can be used for deleting reservations for each day of the week.
- It can be used while confirming or setting reservations.

**1. Press** .

- The day of the week and the reservation number will be displayed.

**2. Press** **to select the day of the week to be deleted.**

**3. Hold** **for about 5 seconds.**

- The reservation of the selected day of the week will be deleted.

**4. Press** .

- If there are still other reservations, WEEKLY TIMER operation will be activated.

### All reservations

**Hold** **for about 5 seconds with the normal display.**

- Be sure to direct the remote controller toward the indoor unit and check for a receiving tone.
- This operation cannot be used for the WEEKLY TIMER setting display.
- All reservations will be deleted.



# Wireless LAN connection

## Please note

- Turn off the air conditioner before setting up wireless connection.

Prior to setting up, please make sure your device is ready to connect. You may refer to the indoor unit LED table for guidance.

### Check the indoor unit LED.

Wireless LAN connecting adapter lamp	Status
Blinks for one second	<ul style="list-style-type: none"> <li>• The wireless LAN connecting adapter is ready to connect.</li> </ul>
No blinking/no light	<ul style="list-style-type: none"> <li>• The wireless LAN connecting adapter is disabled.</li> <li>• Malfunction in communication between the indoor unit and the wireless LAN connecting adapter.</li> </ul> <p>Please refer to the troubleshooting guide or contact the store where you bought the air conditioner to request a repair service.</p>
Lamp stays lit	<ul style="list-style-type: none"> <li>• The wireless LAN connecting adapter is connected to a modem/router.</li> </ul>

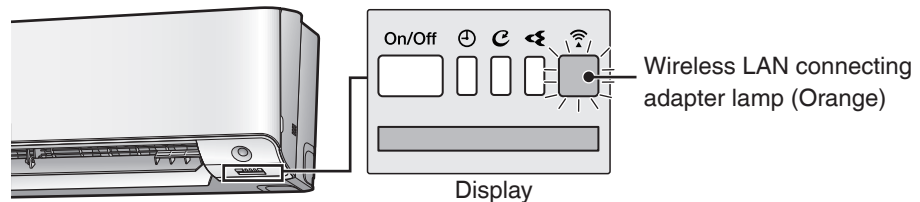

## Wireless LAN connection

Web site: <http://www.daikintha.com/product/dmobile>

For more information on the latest version of wireless LAN control, please refer to the above website.

## Application software installation

- Before downloading the application software for installation, please read “Configuration” on [Page 7](#).

### For Android phones

- 1) Open [Google Play].
- 2) Search using the application name: [DAIKIN Mobile Controller].
- 3) Follow the on-screen instructions for installation.



### For iOS phones

- 1) Open [App Store].
- 2) Search using the application name: [DAIKIN Mobile Controller].
- 3) Follow the on-screen instructions for installation.



## Setting

### Connect the wireless LAN connecting adapter to your home network.

- The wireless LAN connecting adapter will communicate with the smart devices in your home network via a modem, router, or a similar device.

There are two options for connecting the wireless LAN connecting adapter to your smart phone or tablet:

- 1) Simple connection (WPS connection), if there is a WPS button on the router, [Page 36](#).
- 2) Access point connection (AP connection), if there is no WPS button on the router, [Page 37](#).

For more information and Frequently Asked Questions, please refer to:

<http://www.daikintha.com/product/dmobile>

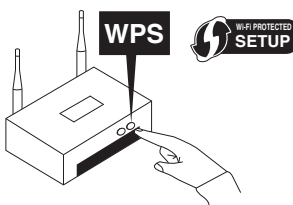

## NOTE

### Note on wireless LAN connection

- For more information on how the wireless LAN connecting adapter operates, please see [Page 35-37](#).



# Wireless LAN connection

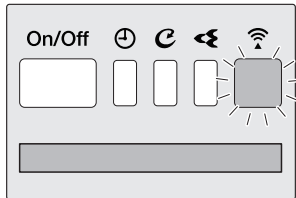
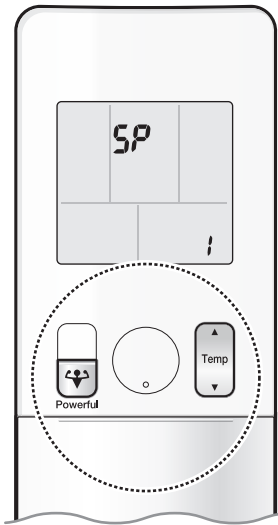

Display

## Enabling/disabling the wireless LAN connecting adapter

### ■ To enable

**1.** While operation is stopped, press  and hold the button for 5 seconds.

- “SP” appears on the LCD.
- “” (SP menu) blinks.



**2.** Press  or  and select SP menu .

**3.** Press  to confirm the selected setting.

- “▲” blinks briefly.
- The wireless LAN connecting adapter lamp (orange) blinks for one second.



**4.** Press  to return to the default screen.

### ■ To disable

**1.** While operation is stopped, press  and hold the button for 5 seconds.

- “SP” appears on the LCD.
- “” (SP menu) blinks.



**2.** Press  or  and select SP menu .

**3.** Press and hold  for 2 seconds to confirm the selected setting.

- “▲” blinks briefly.
- The wireless LAN connecting adapter lamp (orange) goes off.

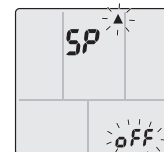

**4.** Press  to return to the default screen.

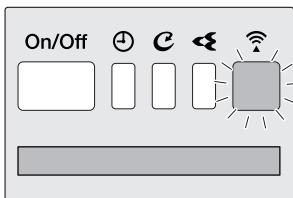
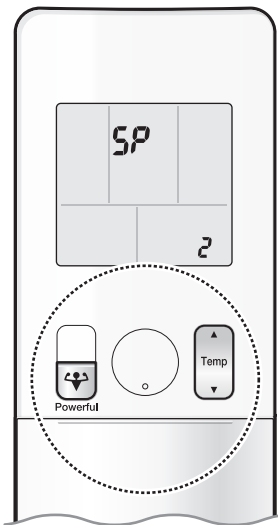

Display



Fig. 1

### To connect the wireless LAN connecting adapter to your home network

The wireless LAN connecting adapter can be connected to your home network by means of:

- Simple connection (WPS connection), if there is a WPS button on the router.
- Access point connection (AP connection), if there is no WPS button on the router.

#### ■ Simple connection (WPS connection)

If there is a WPS button on your Wi-Fi router, please follow the below steps.

**1. While operation is stopped, press  and hold the button for 5 seconds.**

- “SP” appears on the LCD.
- “” (SP menu) blinks.

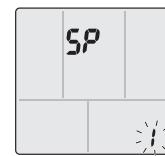

**2. Press  or  and select SP menu .**

**3. Press  to confirm the selected setting.**

- “▲” blinks briefly.
- The wireless LAN connecting adapter lamp (orange) blinks more quickly.



**4. Press the WPS button on your communication device (e.g. router) within approximately one minute. Please refer to the manual of your communication device.**

- The wireless LAN connecting adapter lamp (orange) stays lit. If you fail to connect, refer to NOTE.

**5. Press  to return to the default screen.**

**6. Connect your smart phone to your home network.**

**7. Open the Home screen of the DAIKIN Mobile Controller application. The air conditioner will be listed there (Fig. 1).**

#### NOTE

##### Note on simple connection (WPS connection)

- If you fail to connect (the wireless LAN connecting adapter lamp (orange) continues to blink), repeat steps 1-5.

Alternatively, try connecting via your device directly. Please refer to “Access point connection (AP connection)”. [▶ Page 37](#)





# Wireless LAN connection

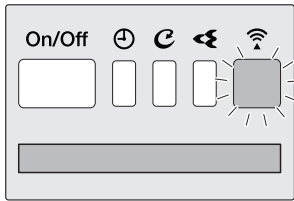

Display

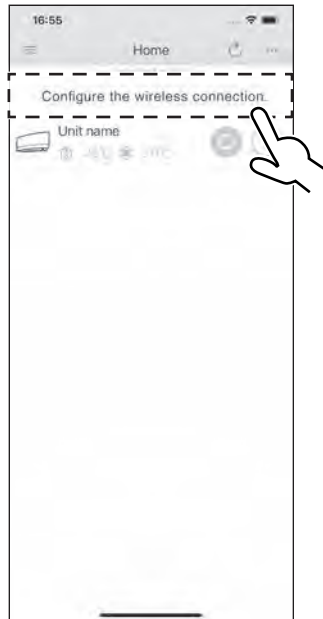
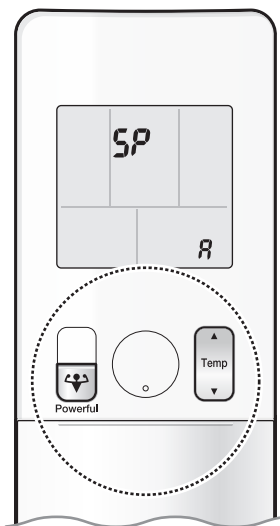

Fig. 2



## ■ Access point connection (AP connection).

If your home Wi-Fi router does not have a WPS button, you can connect your smart phone directly to the wireless LAN connecting adapter in order to set up a connection to your home network by following these steps.  
– This step requires SSID number and KEY located on the indoor unit or on the cover of the manual.

### 1. Connect the wireless LAN connecting adapter to a smart phone or tablet.

View available Wi-Fi networks on your smart phone or tablet and connect to the SSID (DaikinAP\*\*\*\*\*) printed out on the sticker. SSID and KEY are located on the indoor unit or on the cover of the manual, as shown in the below image.

- Sticker on the indoor unit
- SSID&KEY sticker
- Sticker on the cover of the manual

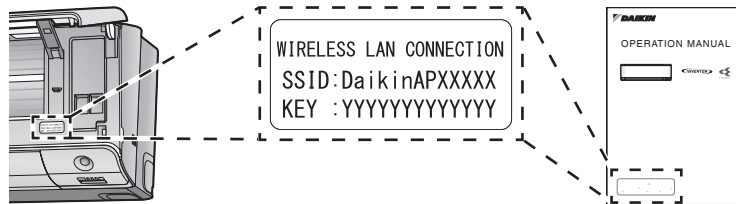

### 2. Open the DAIKIN Mobile Controller application and select “Configure the wireless connection” (Fig. 2) and connect to your home network as per the on-screen instructions.

- The wireless LAN connecting adapter lamp (orange) stays lit. If you fail to connect, refer to NOTE.

### 3. Connect your smart phone to your home network.

### 4. Open the Home screen of the DAIKIN Mobile Controller application. The air conditioner will be listed there.

**Reset connection setting to factory defaults.**

#### Please note

When the device is reset, out-of-home user account and wireless LAN connection setting will be changed back to the factory defaults.

## ■ To reset

### 1. While operation is stopped, press and hold the button for 5 seconds.

- “SP” appears on the LCD.
- “” (SP menu) blinks.



### 2. Press or and select SP menu .

### 3. Press and hold for 2 seconds to confirm the selected setting.

- “▲” blinks briefly.
- The wireless LAN connecting adapter lamp (orange) blinks for one second.

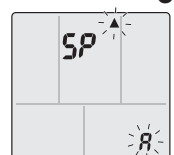

### 4. Press to return to the default screen.

## NOTE

#### Note on access point connection (AP connection)

- If you fail to connect (the wireless LAN connecting adapter lamp (orange) continues to blink), repeat steps 1-2.

# Care and Cleaning

## ⚠ CAUTION

- Before cleaning, be sure to stop the operation and turn off the circuit breaker.
- Do not touch the aluminum fins of the indoor unit. If you touch those parts, this may cause an injury.

### ■ Quick reference

#### Cleaning parts

##### Front panel

- Wipe it with a soft damp cloth.
- Only neutral detergent may be used.

**If dirty**



##### Air filter

- Vacuum dust or wash the filter.

**Once every 2 weeks**

▶ Page 39

##### Indoor unit, outdoor unit and remote controller

- Wipe them with a soft cloth.

**If dirty**

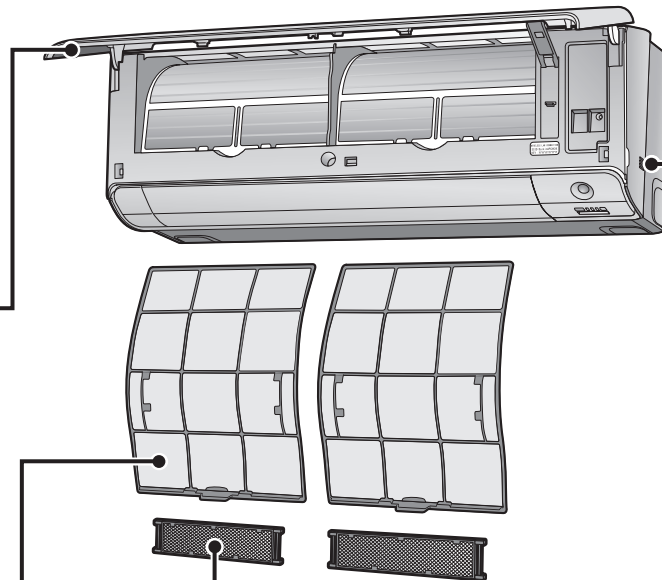

##### Streamer air inlet

- Do not place objects around the indoor unit. Doing so may have an adverse influence on the performance, product quality, and life of the streamer.

#### Deodorizing filter (enzyme blue)

To purchase the filters (Table 1) or to purchase the another type, contact the dealer where you bought the air conditioner. The method of cleaning and replacement of the filters may differ depending on the model. Refer to the label attached to the separately sold filters themselves.

**Table 1**

Item	Part No.
Air quality filter (enzyme blue with PM2.5) - without frame (set of 2)	BAFP094A43
Deodorizing filter (enzyme blue) - without frame (set of 2)	BAFP094A41
Dust collection filter (PM 2.5) - without frame (set of 2)	BAFP046A41
Titanium apatite deodorizing filter - without frame (set of 2)	KAF970A46

#### Deodorizing filter (enzyme blue), Titanium apatite deodorizing filter.

- Vacuum dust or replace the filter.

[Cleaning]

**Once every 6 months**

▶ Page 40

[Replacement]

**Once every 3 years**

▶ Page 40

#### Air quality filter (enzyme blue with PM2.5), Dust collection filter (PM 2.5)

- No cleaning is required. Please replace the filter every 6 months. ▶ Page 40

## NOTE

**For cleaning, do not use any of the following:**

- Water hotter than 40°C
- Volatile liquid such as benzene, petrol and thinner
- Polishing compounds
- Rough materials such as a scrubbing brush

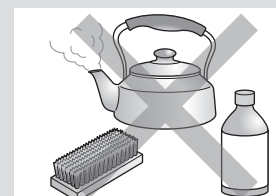

# Care and Cleaning

## ■ Air filter

### 1. Open the front panel.

- Hold the front panel by the sides and open it.

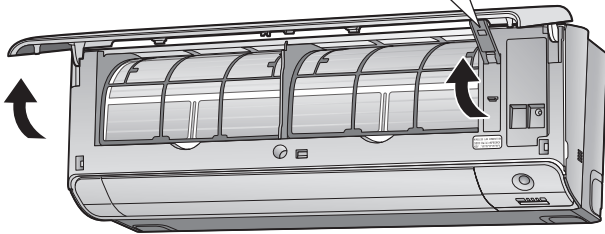
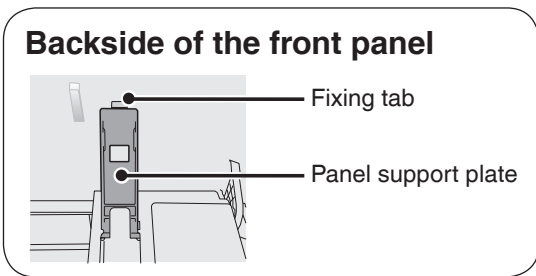

### 2. Pull out the air filters.

- Push the filter tab at the centre of each air filter a little upwards, then pull it down.

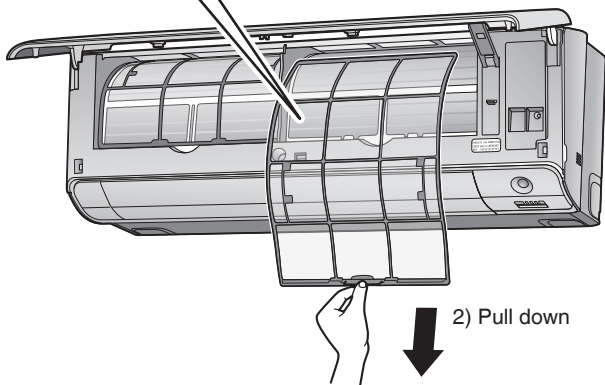
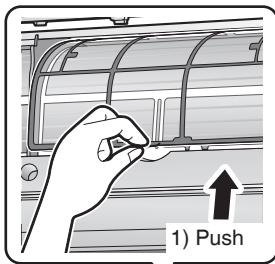

### 3. Wash the air filters with water or clean them with vacuum cleaner.

- It is recommended to clean the air filters every 2 weeks.

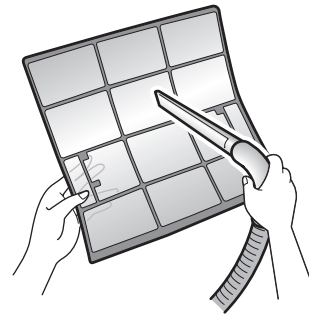

#### If the dust does not come off easily

- Wash the air filters with neutral detergent thinned with lukewarm water, then dry them up in the shade.

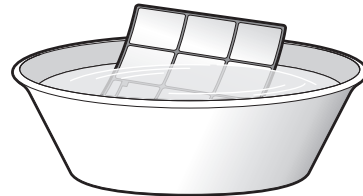

### 4. Reattach the filters.

### 5. Close the front panel slowly.

- Press the panel at both sides and the centre.

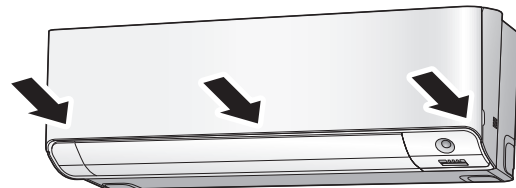

- Make sure that the front panel is securely fixed.

## ■ Filter (small)

\* For the applicable filter type, please refer to **▶Page 38**.

### Attaching

**1. Open the front panel and pull out the air filters.** **▶Page 39**

**2. Insert the filter.**

- Check that the filters are inserted securely under the tabs.

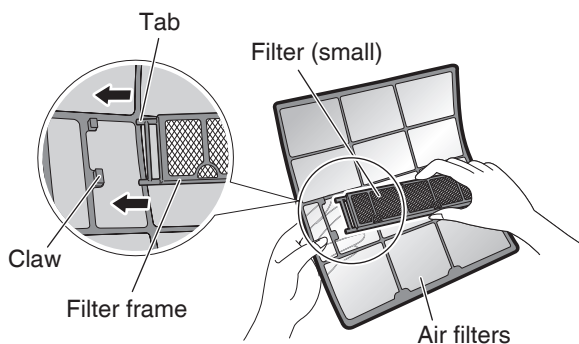

### Cleaning and Replacement

**1. Open the front panel and pull out the air filters.** **▶Page 39**

**2. Take off the filter.**

- Hold the recessed parts of the frame and unhook the 4 claws.
- Remove the filters from the tabs.

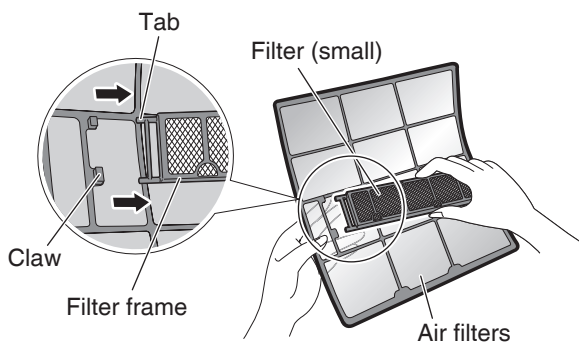

## NOTE

- Operation with dirty filters:
  - cannot deodorise the air,
  - cannot clean the air,
  - results in poor heating or cooling,
  - may cause odour.
- Dispose of old filters as non-flammable waste.

**3. Clean or replace.**

[Cleaning]

■ Deodorizing filter (enzyme blue) : Blue / Titanium apatite deodorizing filter : Blue-Black

**3-1 Vacuum dust, and soak in lukewarm water or water for about 10 to 15 minutes if very dirty.**

**3-2 After washing, shake off remaining water and let them dry in the shade.**

- This filter can be renewed by washing it with water once **every 6 months** and we recommend replacing it once **every 3 years**.
- Do not wiring out the filter when removing water from it.

■ Air quality filter (enzyme blue with PM2.5) : Blue-White/ Dust collection filter (PM 2.5) : White

- Do not wash the filters as this will reduce their efficiency.
- It is recommended to replace it once **every 6 months**.

[Replacement]

**Remove each filter from the front grille by detaching them from the 6 tabs and then install the new filters.**

- Do not throw away the filter frame.
- Reuse the filter frame when replacing the filter.

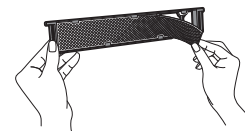

- When attaching the filter, check that the filter is properly set in the tabs.

**4. Set the filters as they were and close the front panel.**

- Press the front panel at both sides and the center.

# Care and Cleaning

## ■ Prior to a long period of non-use

- 1. Operate the MOLD PROOF mode.** ▶Page 17
- 2. After operation stops, turn off the circuit breaker for the room air conditioner.**
- 3. Clean the air filters and reattach them.** ▶Page 39
- 4. To prevent battery leakage, take out the batteries from the remote controller.**

## ■ We recommend periodical maintenance

- In certain operating conditions, the inside of the air conditioner may get foul after several seasons of use, resulting in poor performance. It is recommended to have periodical maintenance by a specialist in addition to regular cleaning by the user.
- For specialist maintenance, please contact the dealer where you bought the air conditioner.
- The maintenance cost must be borne by the user.

# FAQ

## Indoor unit

### The flaps do not start swinging immediately.

- The air conditioner is adjusting the position of the flaps. The flaps will start moving soon.

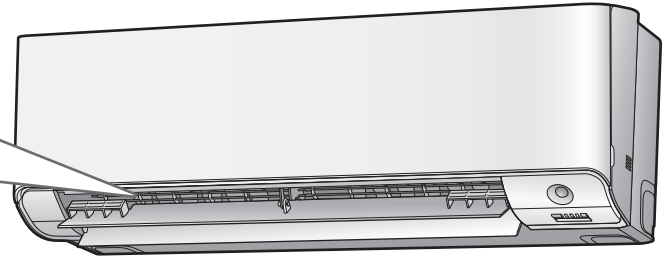

### The air conditioner stops generating airflow during HEAT operation.

- Once the set temperature is reached, the airflow rate is reduced and operation stopped in order to avoid generating a cool airflow. Operation will resume automatically when the indoor temperature falls.

### HEAT operation stops suddenly and a flowing sound is heard.

- The outdoor unit is defrosting. HEAT operation starts after the frost on the outdoor unit has been removed. This can take about 4 to 12 minutes.

### Operation does not start soon.

- When  was pressed soon after operation was stopped.
- When the mode was reselected.
  - This is to protect the air conditioner. You should wait for about 3 minutes.

## Commonly occurring sounds.

### ■ A sound like flowing water

- This sound is generated because the refrigerant in the air conditioner is flowing.
- This is a pumping sound of the water in the air conditioner and can be heard when the water is pumped out from the air conditioner during COOL or DRY operation.
- This sound is generated during COOL operation on outdoor ambient lower than 12°C when outdoor fan stop for keep pressure.

### ■ Blowing sound

- This sound is generated when the flow of the refrigerant in the air conditioner is switched over.

### ■ Ticking sound

- This sound is generated when the cabinet and frame of the air conditioner slightly expand or shrink as a result of temperature changes.

### ■ Whistling sound

- This sound is generated when refrigerant flows during defrosting operation.

### ■ Clicking sound during operation or idle time

- This sound is generated when the refrigerant control valves or the electrical parts operate.

### ■ Clapping sound

- This sound is heard from the inside of the air conditioner when the exhaust fan is activated while the room doors are closed. Open the window or turn off the exhaust fan.

### ■ Hissing/Cracking sound

- The sound of the streamer discharge. It is not a malfunction.

## Outdoor unit

### The outdoor unit emits water or steam.

- In HEAT operation
  - The frost on the outdoor unit melts into water or steam when the air conditioner is in defrosting operation.
- In COOL or DRY operation
  - Moisture in the air condenses into water on the cool surface of the outdoor unit piping and drips.

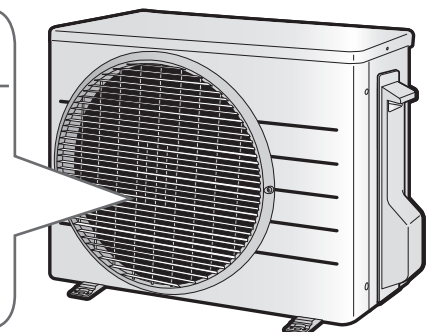

- The appearance of the outdoor unit may differ between different models.

# Troubleshooting

Before making an inquiry or a request for repair, please check the following.  
If the problem persists, consult your dealer.



## Not a problem

This case is not a problem.



## Check

Please check again before requesting repairs.

## Air conditioner

### The air conditioner does not operate

Case	Description / what to check
OPERATION lamp is off.	<ul style="list-style-type: none"> <li>Has the circuit breaker been tripped or the fuse blown?</li> <li>Is there a power failure?</li> <li>Are batteries set in the remote controller?</li> </ul>
OPERATION lamp is blinking.	<ul style="list-style-type: none"> <li>Turn off the power with the circuit breaker and restart operation with the remote controller. If the OPERATION lamp is still blinking, check the error code and consult your dealer. <a href="#">▶ Page 46</a></li> </ul>

### The air conditioner suddenly stops operating

Case	Description / what to check
OPERATION lamp is on.	<ul style="list-style-type: none"> <li>To protect the system, the air conditioner may stop operating after sudden large voltage fluctuations. It automatically resumes operation in about 3 minutes.</li> </ul>
OPERATION lamp is blinking.	<ul style="list-style-type: none"> <li>Is there anything blocking the air inlet or air outlet of the indoor unit or outdoor unit? Stop operation and after turning off the circuit breaker, remove the obstruction. Then restart operation with the remote controller. If the OPERATION lamp is still blinking, check the error code and consult your dealer. <a href="#">▶ Page 46</a></li> </ul>

### The air conditioner does not stop operating

Case	Description / what to check
The air conditioner continues operating even after operation is stopped.	<ul style="list-style-type: none"> <li><b>Immediately after the air conditioner is stopped</b> <ul style="list-style-type: none"> <li>The outdoor unit fan continues rotating for about another 1 minute to protect the system.</li> </ul> </li> <li><b>While the air conditioner is not in operation</b> <ul style="list-style-type: none"> <li>When the outdoor temperature is high, the outdoor unit fan may start rotating to protect the system.</li> </ul> </li> </ul>
	<ul style="list-style-type: none"> <li>MOLD PROOF operation is being performed. It is possible to stop MOLD PROOF operation while it is in progress. (If this does not suit your preferences, set MOLD PROOF to "Off".)</li> </ul>

### The room does not cool down/warm up

Case	Description / what to check
Air does not come out.	<ul style="list-style-type: none"> <li><b>In HEAT operation</b> <ul style="list-style-type: none"> <li>The air conditioner is warming up. Wait for about 1 to 4 minutes.</li> <li>During defrosting operation, hot air does not flow out of the indoor unit.</li> </ul> </li> <li><b>In COOL or DRY operation</b> <ul style="list-style-type: none"> <li>If COOL/DRY operation is started with airflow settings on "AUTO", the indoor unit will initially deodorise, which functions to suppress any internal odours. As a result, the indoor unit will not emit air immediately. (Wait for about 1 minute.)</li> </ul> </li> <li><b>When the air conditioner operates immediately after the circuit breaker is turned on</b> <ul style="list-style-type: none"> <li>The air conditioner is preparing to operate. Wait for about 3 to 15 minutes.</li> </ul> </li> </ul>
Air does not come out / Air comes out.	<ul style="list-style-type: none"> <li><b>Is the airflow rate setting appropriate?</b> <ul style="list-style-type: none"> <li>Is the airflow rate setting low, such as "Indoor unit quiet" or "Airflow rate 1"? Increase the airflow rate setting.</li> </ul> </li> <li><b>Is the set temperature appropriate?</b></li> <li><b>Is the adjustment of the airflow direction appropriate?</b></li> </ul>
Air comes out.	<ul style="list-style-type: none"> <li>Is there any furniture directly under or beside the indoor unit?</li> <li>Is the air conditioner in ECONO operation or OUTDOOR UNIT QUIET operation? <a href="#">▶ Page 24</a></li> <li>Are the air filters dirty?</li> <li>Is there anything blocking the air inlet or air outlet of the indoor unit or outdoor unit?</li> <li>Is a window or door open?</li> <li>Is an exhaust fan turning?</li> </ul>
The room temperature does not reach the set temperature.	<ul style="list-style-type: none"> <li>If the air coming out of the air conditioner is blowing against a wall, the set temperature may not be reached correctly.</li> </ul>



## Air conditioner

### Mist comes out

Case	Description / what to check
Mist comes out of the indoor unit.	<input checked="" type="checkbox"/> • This happens when the air in the room is cooled into mist by the cold airflow during COOL or other operation.

### Remote controller

Case	Description / what to check
The unit does not receive signals from the remote controller or has a limited operating range.	<input checked="" type="checkbox"/> • The batteries may be exhausted. Replace both batteries with new dry batteries AAA.LR03 (alkaline). For details, refer to “Preparation Before Operation”. ▶Page 10 <input checked="" type="checkbox"/> • Signal communication may be disabled if an electronic-starter-type fluorescent lamp (such as inverter-type lamps) is in the room. Consult your dealer if that is the case. <input checked="" type="checkbox"/> • The remote controller may not function correctly if the transmitter is exposed to direct sunlight.
LCD is faint, is not working, or the display is erratic.	<input checked="" type="checkbox"/> • The batteries may be exhausted. Replace both batteries with new dry batteries AAA.LR03 (alkaline). For details, refer to “Preparation Before Operation”. ▶Page 10
The LCD is blinking and the remote controller cannot be operated.	<input checked="" type="checkbox"/> • Battery power has run out. Replace both batteries at the same time with new size AAA.LR03 (alkaline) batteries. Leaving exhausted batteries in the remote controller can result in injury due to battery leakage, rupturing or heating, or lead to equipment failure. (Even when the LCD is blinking, the OFF button remains functional.)
Other electric devices start operating.	<input checked="" type="checkbox"/> • If the remote controller activates other electric devices, move them away or consult your dealer.

### Air has an odour

Case	Description / what to check
The air conditioner gives off an odour.	<input checked="" type="checkbox"/> • The room odour absorbed in the unit is discharged with the airflow. We recommend that you have the indoor unit cleaned. Please consult your dealer. <input checked="" type="checkbox"/> • Due to streamer discharge, the air outlet may emit a slight odour as trace amounts of ozone are generated. However, the amount is negligible and is not harmful to your health.

### Display lamps

Case	Description / what to check
The OPERATION lamp is off, but the air conditioner is operating.	<input type="checkbox"/> • Is the display brightness set to “Off”?
	<input checked="" type="checkbox"/> • MOLD PROOF operation is being performed. It is possible to stop MOLD PROOF operation while it is in progress. (If this does not suit your preferences, set MOLD PROOF to “Off”.)
The display lamps on the main unit are dark.	<input type="checkbox"/> • Is the display brightness set to “Low”?

### Streamer air cleaning operation

Case	Description / what to check
The sound of streamer discharge can no longer be heard.	<input checked="" type="checkbox"/> • If the airflow becomes weak, the streamer discharge stops.

### Others

Case	Description / what to check
The air conditioner suddenly starts behaving strangely during operation.	<input type="checkbox"/> • The air conditioner may malfunction due to lightning or radio. If the air conditioner malfunctions, turn off the power with the circuit breaker and restart the operation with the remote controller.
The ON/OFF TIMER does not operate according to the settings.	<input checked="" type="checkbox"/> • Check if the ON/OFF TIMER and the WEEKLY TIMER are set to the same time. Change or deactivate the settings in the WEEKLY TIMER. ▶Page 28,29,30

## NOTE

### Note on the operating conditions

- If operation continues under any conditions other than those listed in the table,
  - A safety device may activate to stop the operation.
  - Dew may form on the indoor unit and drip from it when COOL or DRY operation is selected.

Mode	Operating conditions
COOL / DRY	Outdoor temperature: –10.0~46.0°C Indoor temperature: 18.0~32.0°C Indoor humidity: 80% max.
HEAT	Outdoor temperature: –15.0~24.0°C Indoor temperature: 10.0~30.0°C

# Troubleshooting

## Wireless LAN connecting adapter

The following table provides brief descriptions of how to handle problems or carry out connection setting. Refer to the FAQ on our web site for more details.

### Wireless LAN connection

When this happens	Explanation and where to check
The device (air conditioner) cannot be found on the device list screen.	<ul style="list-style-type: none"> <li>✓ Carry out connection setting again.</li> <li>Move the router (wireless LAN access point) close to the indoor unit.</li> <li>There is a possibility that you are using an unsupported smart phone or router (wireless LAN access point). For details, refer to the web site.</li> </ul>
Even if the wireless LAN connecting adapter lamp is lit, operation from outside the home is not possible.	<ul style="list-style-type: none"> <li>✓ Communication between the router and the internet connection may not be working. Please confirm.</li> </ul>
The wireless LAN connecting adapter lamp does not blink or light.	<ul style="list-style-type: none"> <li>? The wireless LAN connecting adapter is disabled.</li> <li>Malfunction in communication between the indoor unit and the wireless LAN connecting adapter.</li> <li>There may be a problem with your device. Please contact the store where you bought the air conditioner to request a repair service.</li> </ul>
None of the above work.	<ul style="list-style-type: none"> <li>? Refer to the FAQ on: <a href="http://www.daikinthal.com/product/dmobile">http://www.daikinthal.com/product/dmobile</a></li> </ul>

For instructions about how to operate the DAIKIN Mobile Controller application, please refer to the operation manual at <http://www.daikinthal.com/product/dmobile>

### ■ Call your dealer immediately

#### WARNING

**When an abnormality (such as a burning smell) occurs, stop operation and turn off the circuit breaker.**

- Continued operation in an abnormal condition may result in problems, electric shock or fire.
- Consult the dealer where you bought the air conditioner.

**Do not attempt to repair or modify the air conditioner by yourself.**

- Incorrect work may result in electric shock or fire.
- Consult the dealer where you bought the air conditioner.

### If one of the following symptoms occurs, call your dealer immediately.

- The power cord is abnormally hot or damaged.
- An abnormal sound is heard during operation.
- The circuit breaker, a fuse, or the earth leakage circuit breaker cuts off the operation frequently.
- A switch or a button often fails to work properly.
- There is a burning smell.
- Water leaks from the indoor unit.

Turn off the circuit breaker and call your dealer.



#### ■ After a power failure

- The air conditioner automatically resumes operation in about 3 minutes. Please wait for a while.

#### ■ Lightning

- If there is a risk lightning could strike in the neighbourhood, stop operation and turn off the circuit breaker to protect the system.

### ■ Disposal requirements

- Dismantling of the unit and handling of the refrigerant, oil and other parts should be done in accordance with the relevant local and national regulations.

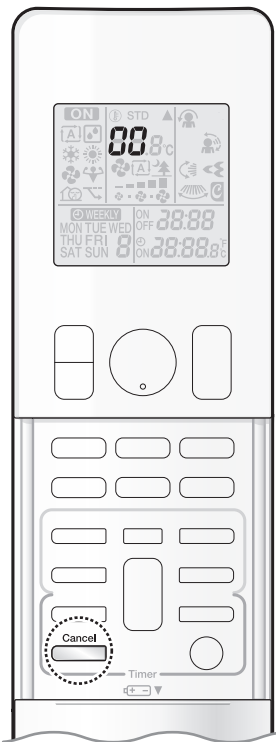

### ■ Fault diagnosis by remote controller

- In case the air conditioner is malfunctioning, you can check the error code via the remote controller before consulting with service personnel and informing them of the malfunction code.

**1.** When  is held down for about 5 seconds, “00” blinks in the temperature display section.

**2.** Press  repeatedly until a long beep is produced.

- The code indication changes as shown below, and notifies you with a long beep.

	CODE	MEANING
SYSTEM	00	NORMAL
	UA	INDOOR-OUTDOOR UNIT COMBINATION FAULT
	U0	REFRIGERANT SHORTAGE
	U2	DROP VOLTAGE OR MAIN CIRCUIT OVERVOLTAGE
	U4	FAILURE OF TRANSMISSION (BETWEEN INDOOR UNIT AND OUTDOOR UNIT)
INDOOR UNIT	A1	INDOOR PCB DEFECTIVENESS
	A5	HIGH PRESSURE CONTROL OR FREEZE-UP PROTECTOR
	A6	FAN MOTOR FAULT
	C4	FAULTY HEAT EXCHANGER TEMPERATURE SENSOR
	C9	FAULTY SUCTION AIR TEMPERATURE SENSOR
	CC	FAULTY HUMIDITY SENSOR
OUTDOOR UNIT	EA	COOLING-HEATING SWITCHING ERROR
	E1	CIRCUIT BOARD FAULT
	E5	OL STARTED
	E6	FAULTY COMPRESSOR START UP
	E7	DC FAN MOTOR FAULT
	F3	HIGH TEMPERATURE DISCHARGE PIPE CONTROL
	F6	HIGH PRESSURE CONTROL (IN COOLING)
	F8	OPERATION HALT DUE TO COMPRESSOR INTERNAL TEMPERATURE
	H0	SENSOR FAULT
	H6	OPERATION HALT DUE TO FAULTY POSITION DETECTION SENSOR
	H8	DC CURRENT SENSOR FAULT
	H9	FAULTY SUCTION AIR TEMPERATURE SENSOR
	J3	FAULTY DISCHARGE PIPE TEMPERATURE SENSOR
	J6	FAULTY HEAT EXCHANGER TEMPERATURE SENSOR
	J8	FAULTY LIQUID PIPE TEMPERATURE SENSOR
	L3	ELECTRICAL PARTS HEAT FAULT
L4	HIGH TEMPERATURE AT INVERTER CIRCUIT HEATSINK	
L5	OUTPUT OVERCURRENT	
P4	FAULTY INVERTER CIRCUIT HEATSINK TEMPERATURE SENSOR	

### NOTE

- A short beep and 2 consecutive beeps indicate non-corresponding codes.
- To cancel the code display, hold  down for about 5 seconds. The code display also clears if no button is pressed for 1 minute.

# Quick Reference

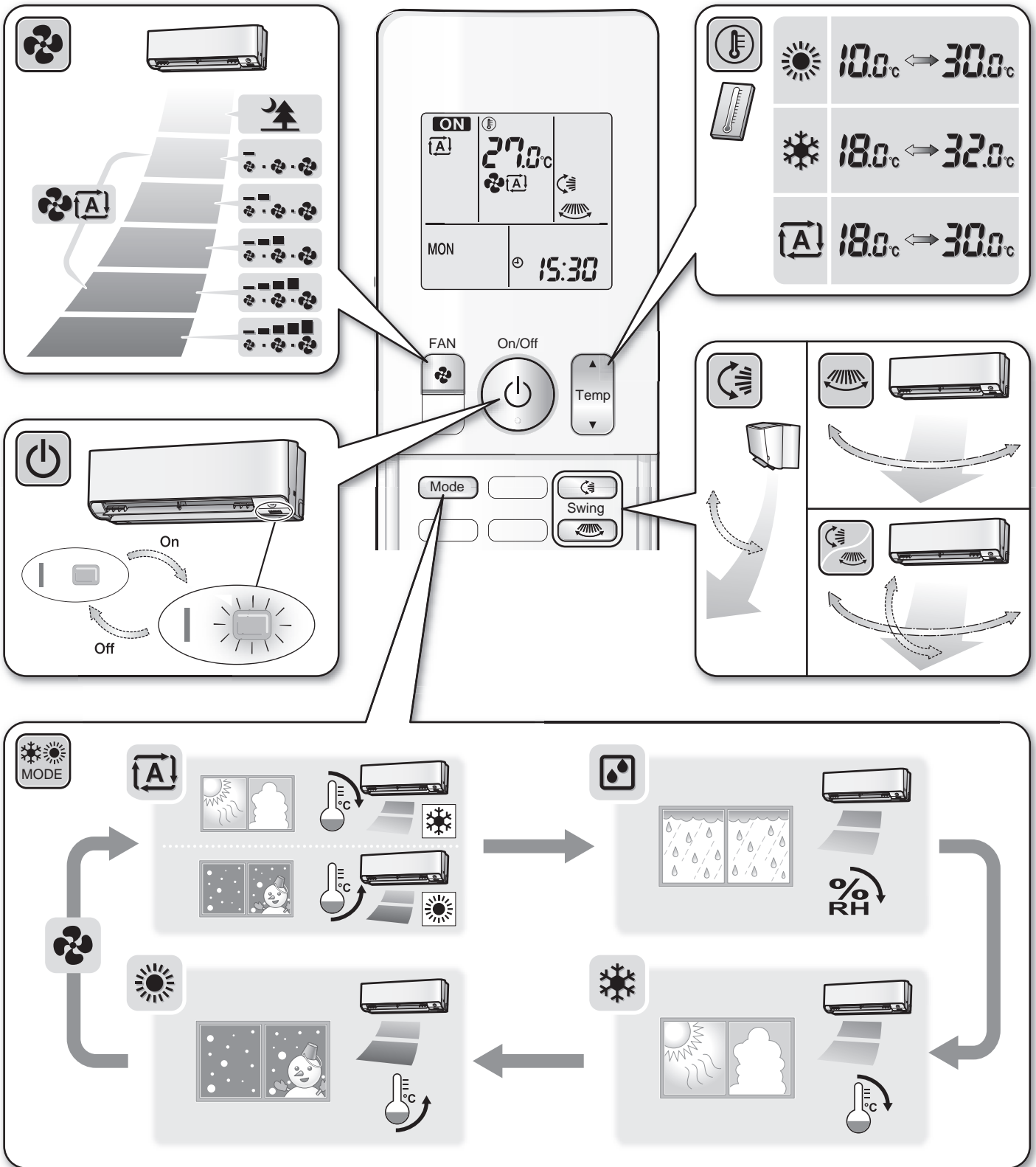

## DAIKIN INDUSTRIES, LTD.

Head office:  
 Umeda Center Bldg., 2-4-12, Nakazaki-Nishi,  
 Kita-ku, Osaka, 530-8323 Japan

Tokyo office:  
 JR Shinagawa East Bldg., 2-18-1, Konan,  
 Minato-ku, Tokyo, 108-0075 Japan  
<https://www.daikin.com>



The two-dimensional bar code is a manufacturing code.

3P651499-1 M21N017 (2106)HT