

DAIKIN

DAIKIN ROOM AIR CONDITIONER

OPERATION MANUAL

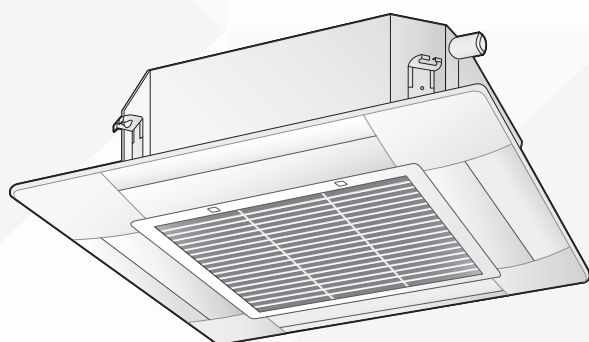

INVERTER

Enjoy year-round comfort.

MODELS

**FFA25RV1A
FFA35RV1A
FFA50RV1A
FFA60RV1A**

Contents

| | | | |
|--------------------------------|----------|-------------------------------|----------|
| ■ Read Before Operation | | ■ Care | |
| Safety Precautions..... | 1 | Care and Cleaning..... | 7 |
| Names of Parts | 4 | ■ When the Need Arises | |
| ■ Multi Connection | | Troubleshooting | |
| Note for Multi System | 5 | 10 | |

Safety Precautions



Read the precautions in this manual carefully before operating the unit.



This appliance is filled with R32.

- Keep this manual where the user can easily find it.
- The precautions described herein are classified as WARNING and CAUTION. They both contain important information regarding safety. Be sure to observe all precautions without fail.

WARNING

Failure to follow these instructions properly may result in personal injury or loss of life.

CAUTION

Failure to follow these instructions properly may result in property damage or personal injury, which may be serious depending on the circumstances.



Never attempt.



Be sure to follow the instructions.



Be sure to establish an earth connection.

- After reading, keep this manual in a convenient place so that you can refer to it whenever necessary. If the equipment is transferred to a new user, be sure also to hand over the manual.

Safety Precautions



WARNING



- Do not use means to accelerate the defrosting process or to clean, other than those recommended by the manufacturer.
- The appliance must be stored in a room without continuously operating ignition sources (for example: open flames, an operating gas appliance or an operating electric heater).
- Do not pierce or burn.
- Be aware that refrigerants may not contain an odour.
- The appliance must be installed, operated and stored in a room with a floor area larger than 8.3m². Maintain an installation height of 2.5m or more from the floor surface to the bottom of the appliance. If the size of the room where the appliance is to be installed has less than the indicated minimum floor area, install it in a well ventilated room.
- To avoid fire, explosion or injury, do not operate the unit when harmful gases (e.g. flammable or corrosive) are detected near the unit.
- Be aware that prolonged, direct exposure to cool or warm air from the air conditioner, or to air that is too cool or too warm, can be harmful to your physical condition and health.
- Do not place objects, including rods, your fingers, etc., in the air inlet or outlet. Product damage or personal injury may result due to contact with the air conditioner's high-speed fan blades.
- Do not attempt to repair, dismantle, reinstall or modify the air conditioner yourself as this may result in water leakage, electric shock or fire hazards.
- Do not use flammable spray near the air conditioner, or otherwise fire may result.
- Do not use a refrigerant other than the one indicated on the outdoor unit (R32) when installing, moving or repairing. Using other refrigerants may cause trouble or damage to the unit, and personal injury.
- To avoid electric shock, do not operate with wet hands.
- Do not start or stop operating the air conditioner with the power supply circuit breaker turned ON or OFF. Otherwise, fire or water leakage may result. Furthermore, the fan will rotate abruptly if power failure compensation is enabled, which may result in injury.



- Beware of fire in case of refrigerant leakage. If the air conditioner is not operating correctly, i.e. not generating cool or warm air, refrigerant leakage could be the cause. Consult your dealer for assistance. The refrigerant within the air conditioner is safe and normally does not leak. However, in the event of a leakage, contact with a naked burner, heater or cooker may result in generation of noxious gas. Do not use the air conditioner until a qualified service person confirms that the leakage has been repaired.
- Do not attempt to install or repair the air conditioner yourself. Improper workmanship may result in water leakage, electric shock or fire hazards. Please contact your local dealer or qualified personnel for installation and maintenance work.
- If the air conditioner is malfunctioning (giving off a burning odour, etc.), turn off power to the unit and contact your local dealer. Continued operation under such circumstances may result in a failure, electric shock or fire hazards.
- Be sure to install an earth leakage circuit breaker. Failure to install an earth leakage circuit breaker may result in electric shock or fire.
- Consult the dealer if the air conditioner submerges owing to a natural disaster, such as a flood or typhoon. Do not operate the air conditioner in that case, or otherwise a malfunction, electric shock, or fire may result.



- Be sure to earth the unit. Do not earth the unit to a utility pipe, lightning conductor or telephone earth lead. Imperfect earthing may result in electric shock.

Safety Precautions



CAUTION



- Do not use the air conditioner for purposes other than those for which it is intended. Do not use the air conditioner for cooling precision instruments, food, plants, animals or works of art as this may adversely affect the performance, quality and/or longevity of the object concerned.
- Do not expose plants or animals directly to the airflow from the unit as this may cause adverse effects.
- Do not place appliances that produce naked flames in places exposed to the airflow from the unit as this may impair combustion of the burner.
- Do not block the air inlets nor outlets. Impaired airflow may result in insufficient performance or trouble.
- Do not sit on the outdoor unit, put things on the unit, or pull the unit. Doing so may cause accidents, such as falling or toppling down, thus resulting in injury, product malfunctioning, or product damage.
- Do not place objects that are susceptible to moisture directly beneath the indoor or outdoor units. Under certain conditions, condensation on the main unit or refrigerant pipes, air filter dirt or drain blockage may cause dripping, resulting in fouling or failure of the object concerned.
- After prolonged use, check the unit stand and its mounts for damage. If they are left in a damaged condition, the unit may fall and cause injury.
- To avoid injury, do not touch the air inlet or aluminium fins of the indoor or outdoor units.
- The appliance is not intended for use by unattended young children or infirm persons. Impairment of bodily functions and harm to health may result.
- Children should be supervised to ensure that they do not play with the unit or its remote controller. Accidental operation by a child may result in impairment of bodily functions and harm health.
- Avoid impacts to the indoor and outdoor units, or otherwise product damage may result.
- Do not place flammable items, such as spray cans, within 1m of the air outlet.
The spray cans may explode as a result of hot air from the indoor or outdoor units.
- Be careful not to let pets urinate on the air conditioner. Urination on the air conditioner may result in electric shock or fire.
- Do not wash the air conditioner with water, as this may result in electric shock or fire.
- Do not place water containers (vases, etc.) above the unit, as this may result in electric shock or fire hazards if they should topple over.
- Do not insert the batteries in the wrong polarity (+/-) orientation as this may result in short circuiting, fire, or battery leakage.
- Do not remove the outdoor unit's fan guard.
The guard protects against the unit's high speed fan, which may cause injury.
- Do not place heaters directly below the unit, as resulting heat can cause deformation.
- Do not leave the remote controller wherever there is a risk of wetting.
If water gets into the remote controller there is a risk of electrical leakage and damage to electronic components.



- To avoid oxygen depletion, ensure that the room is adequately ventilated if equipment such as a burner is used together with the air conditioner.
- Before cleaning, be sure to stop unit operation and turn off the circuit breaker. Otherwise, an electric shock and injury may result.
- Only connect the air conditioner to the specified power supply circuit. Power supplies other than the one specified may result in electric shock, overheating and fires.
- Arrange the drain hose to ensure smooth drainage. Imperfect drainage may cause wetting of the building, furniture, etc.
- Do not place objects in direct proximity of the outdoor unit and do not let leaves and other debris accumulate around the unit. Leaves are a hotbed for small animals which can enter the unit. Once inside the unit, such animals can cause malfunctions, smoke or fire if they come into contact with electrical parts.
- Do not place objects around the indoor unit.
Doing so may have an adverse influence on the performance, product quality, and life of the air conditioner.
- This appliance is not intended to be used by persons with reduced physical, sensory or mental capabilities, or with lack of operation knowledge, unless they have been given supervision or instruction concerning the appliance use by person responsible for their safety. Keep out of children's reach to ensure that they do not play with the appliance.
- For care and cleaning, call service personnel.
- Never touch the internal parts of the controller.
Touching certain internal parts will cause electric shock and damage to the unit. Please consult your dealer about checking and adjustment of internal parts.

FFP001

This is an appliance that is not accessible to the general public.

Precautions relating to area surrounding the indoor and outdoor units

- Be sure to follow the instructions below.
 - The indoor unit is at least 1m away from any television or radio set (unit may cause interference with the picture or sound).
 - Refrain from using the units in areas prone to high levels of oily smoke, such as a kitchen.
Water leakage may result.

Names of Parts

Indoor Unit

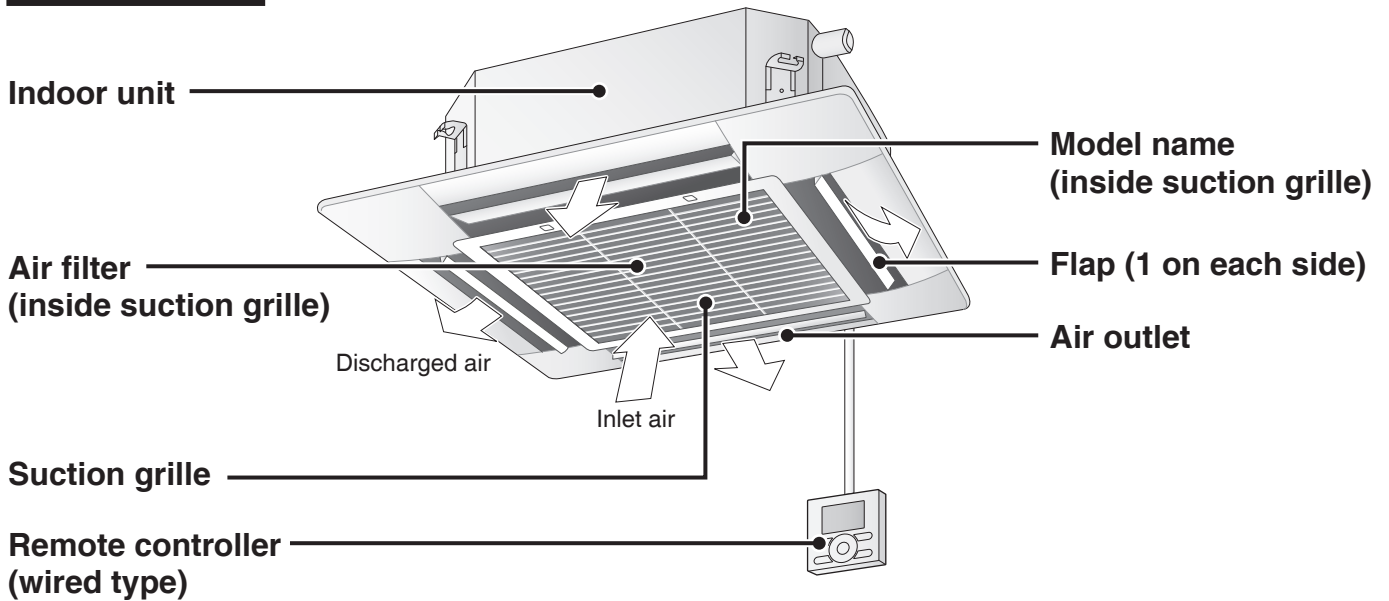

• The appearance of the remote controller may differ between different models.

Decoration panel

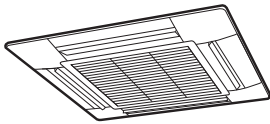

Remote controller

Wired type

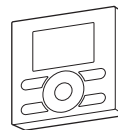

Wireless type



• For details on remote controller operation, refer to the operation manual included with the remote controller.

Outdoor Unit

• The appearance of the outdoor unit may differ between different models.

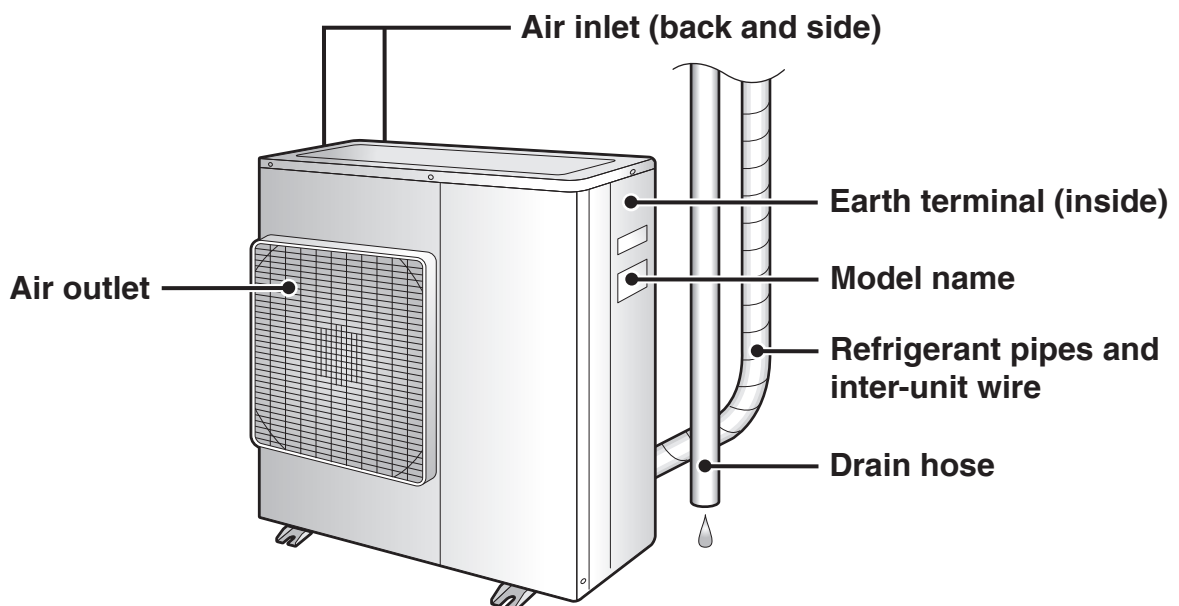

Note for Multi System

A multi system has one outdoor unit connected to multiple indoor units.

Selecting the operation mode

When the priority room setting is active but the set unit is not operating or when the priority room setting is inactive

When more than one indoor unit is operating, priority is given to the first unit that was turned on.

In this case, set the units that are turned on later to the same operation mode as the first unit.

Otherwise, they will enter the standby state, and when using the wired remote controller the centralized control icon “” will light up; this does not indicate malfunction.

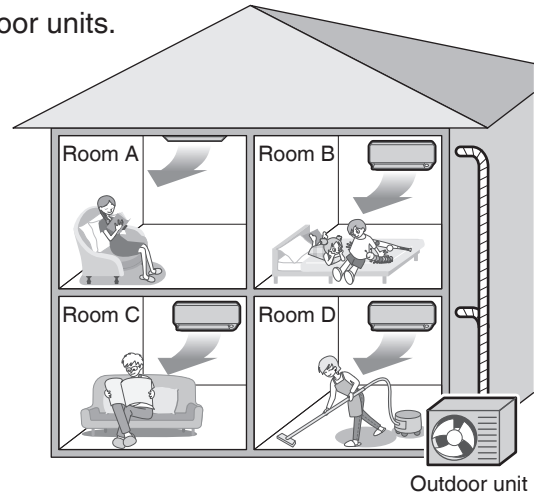

NOTE

Notes on operation mode for a multi system

- COOL, DRY and FAN operation may be used at the same time.
- AUTO operation automatically selects COOL operation or HEAT operation based on the indoor temperature. Therefore, AUTO operation is available when selecting the same operation mode as that of the room with the first unit to be turned on.

CAUTION

- Normally, the operation mode in the room where the unit is first started is given priority, but the following situations are exceptions to this rule. If the operation mode of the first room is FAN operation, then using HEAT operation in any room after this will give priority to HEAT operation. In this situation, the indoor unit operating in FAN mode will switch to standby, and when using the wired remote controller the centralized control icon “” will light up.

With the priority room setting active

Refer to “**Priority room setting**” on the next page.

NIGHT QUIET mode (Available only for COOL operation)

NIGHT QUIET mode requires initial programming during installation. Please consult your retailer or dealer for assistance.

NIGHT QUIET mode reduces the operation noise of the outdoor unit during the night-time hours to prevent annoyance to neighbours.

- NIGHT QUIET mode is activated when the temperature drops 6°C or more below the highest temperature recorded that day. When the temperature difference between the current outdoor temperature and the maximum outdoor temperature becomes less than 4°C, this function will be cancelled.
- NIGHT QUIET mode slightly reduces the cooling efficiency of the unit.

OUTDOOR UNIT QUIET operation (Function unavailable in the FFA series)

For details on OUTDOOR UNIT QUIET operation, refer to the operation manual included with the remote controller.

When the priority room setting is active but the set unit is not operating or when the priority room setting is inactive

When using the OUTDOOR UNIT QUIET operation feature with a multi system, set all indoor units to OUTDOOR UNIT QUIET operation using their remote controllers.

When cancelling OUTDOOR UNIT QUIET operation, simply cancel the mode on one of the operating indoor units using their remote controller.

However OUTDOOR UNIT QUIET operation will remain displayed on the remote controllers for the other rooms.

We recommend you cancel operation in all rooms using their remote controllers.

With the priority room setting active

Refer to “**Priority room setting**” on the next page.

COOL/HEAT mode lock

The COOL/HEAT mode lock requires initial programming during installation. Please consult your authorized dealer for assistance. The COOL/HEAT mode lock sets the unit forcibly to either COOL or HEAT operation. This function is convenient when you wish to set all indoor units connected to the multi system to the same operation mode.

NOTE

- The COOL/HEAT mode lock cannot be activated together with the priority room setting.

Priority room setting

The priority room setting requires initial programming during installation. Please consult your authorized dealer for assistance. The room designated as the priority room takes priority in the following situations.

Operation mode priority

- As the operation mode of the priority room takes precedence, you can select a different operation mode from other rooms.

[Example]

- Room A is the priority room in this example.

When COOL operation is selected in room A while operating the following modes in room B, C and D:

| Operation mode in room B, C and D | Status of room B, C and D when the unit in room A is in COOL operation |
|-----------------------------------|---|
| COOL or DRY or FAN | The current operation mode is maintained. |
| HEAT | The unit enters the standby mode. Operation resumes when the room A unit stops operating. |
| AUTO | If the unit is set to COOL operation, it continues. If the unit is set to HEAT operation, it enters the standby mode. Operation resumes when the room A unit stops operating. |

Priority when SUPER POWERFUL / HEAT PLUS operation is used (Function unavailable in the FFA series)

[Example]

- Room A is the priority room in this example.

The indoor units in rooms A, B, C and D are all operating. If the unit in room A enters SUPER POWERFUL / HEAT PLUS operation, operation capacity will be concentrated in room A. In such a case, the cooling (heating) efficiency of the units in room B, C and D may be slightly reduced.

Priority when OUTDOOR UNIT QUIET operation is used (Function unavailable in the FFA series)

[Example]

- Room A is the priority room in this example.

Just by setting the unit in room A to QUIET operation, the air conditioner starts OUTDOOR UNIT QUIET operation. You do not have to set all the indoor units in operation to OUTDOOR UNIT QUIET operation.

Care and Cleaning

WARNING

- Only a qualified service person is allowed to perform maintenance.
- Before cleaning, be sure to stop unit operation and turn off the circuit breaker.
Otherwise, an electric shock and injury may result.
- Contact a qualified person regarding the attachment of accessories and be sure to use only accessories specified by the manufacturer.
If an accessory is attached incorrectly, water leakage, an electric shock, or fire may result.

CAUTION

- When cleaning, use a sturdy and stable stand and watch your step.
- Make sure to firmly support the suction grille with your hand while performing maintenance tasks to prevent it from falling out.

■ Quick reference

Cleaning parts

Outside panel and flaps

- Wipe the parts with a soft cloth.
- When it is difficult to remove stains, use water or a neutral detergent.
- If the flaps are stained severely, contact your dealer and have the flaps replaced.

If dirty

Air filter

- Vacuum dust or wash the filter.

When the air filter cleaning time indicator lamp on the decoration panel lights up or when "Time to clean filter" displays on the wired remote controller

▶ Page 8

Remote controller

- Wipe them with a soft cloth.

If dirty

Suction grille

- Wipe it with a soft damp cloth.

If dirty ▶ Page 9

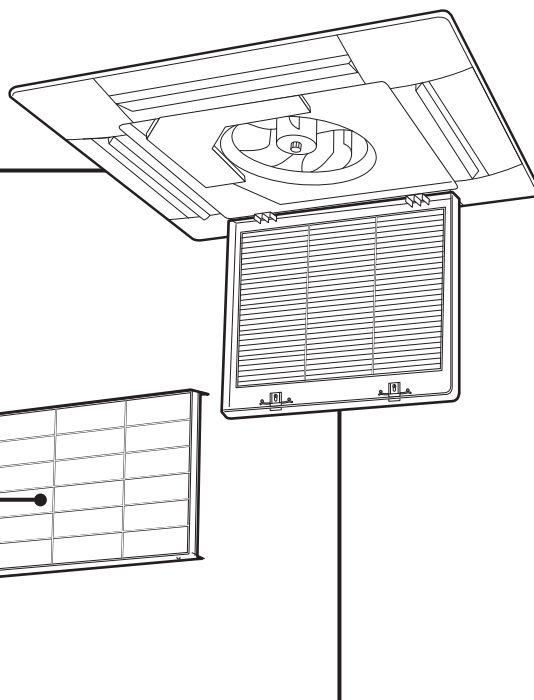

NOTE

For cleaning, do not use any of the following:

- Water hotter than 40°C
- Volatile liquid such as benzene, petrol and thinner
- Polishing compounds or liquid insecticide
- Rough materials such as a scrubbing brush

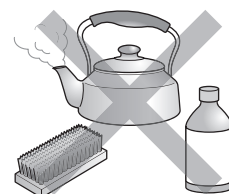

■ Cleaning the air filter

Clean the air filter when the air filter cleaning time indicator lamp on the decoration panel lights up or when "Time to clean filter" displays on the wired remote controller.

- If the unit is installed in a room where the impurity content of the air is high, clean the filter more frequently.
- If the filter has become difficult to clean, replace the air filter. (Additional air filter sold separately.)

1. Open the suction grille.

- Push the 2 catches away from you and slowly open the suction grille. (To close, perform the steps in reverse.)

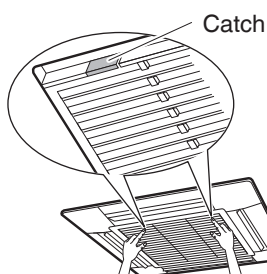

2. Remove the air filter.

- Pull the knobs of the air filter downward to disconnect the hooks, and remove the air filter.

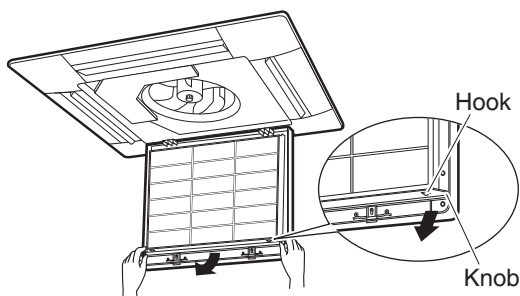

3. Clean the air filter with a vacuum cleaner or wash it with water.

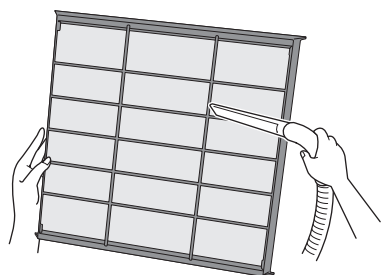

If the dust does not come off easily

- Wash the air filter using a soft brush and a neutral detergent, then let it dry in the shade.

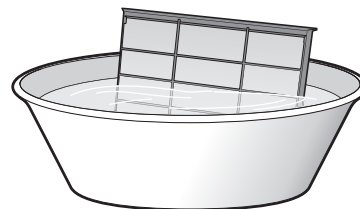

4. Reattach the air filter.

- 4-1 Hook one side of the air filter on to the protrusions on the suction grille.
- 4-2 Push the other side of the air filter into place.

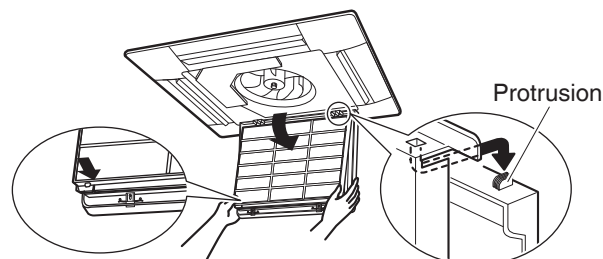

5. Close the suction grille.

- Refer to STEP 1.

6. After turning on the power, reset the filter sign in accordance with the instructions in the operation manual for the wired remote controller or wireless remote controller.

- The air filter cleaning time indicator lamp on the decoration panel turns off or "Time to clean filter" disappears from the display on the wired remote controller.

Care and Cleaning

■ Cleaning the suction grille

1. Open the suction grille.

- Push the 2 catches away from you and slowly open the suction grille. (To close, perform the steps in reverse.)

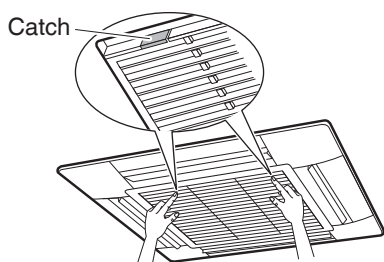

2. Remove the suction grille.

- Open the suction grille until it is 45 degrees to the ceiling and then lift it upward.

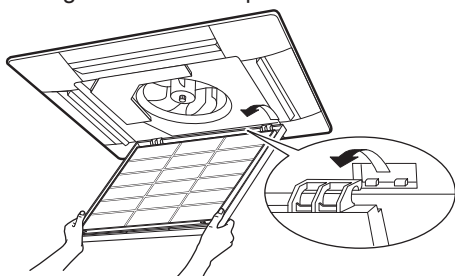

3. Remove the air filter. ▶Page 8

4. Clean the suction grille.

Wash with a soft bristle brush and a neutral detergent or water, and dry thoroughly.



• When very dirty

Directly apply the type of detergent used for cleaning ventilation fans or ovens, wait for about 10 minutes, and then rinse with water.

5. Reattach the air filter. ▶Page 8

6. Reattach the suction grille.

- Refer to STEP 2.

7. Close the suction grille.

- Refer to STEP 1.

■ Prior to a long period of non-use

1. Operate the FAN mode for several hours to dry out the inside.

- To start the operation, refer to the operation manual for the remote controller.

2. After operation stops, turn off the circuit breaker for the room air conditioner.

3. Clean the air filter and reattach it.

4. To prevent battery leakage, take out the batteries from the remote controller. (Only for the wireless remote controller)

■ We recommend periodical maintenance

- In certain operating conditions, the inside of the air conditioner may get foul after several seasons of use, resulting in poor performance. It is recommended to have periodical maintenance by a qualified contractor.
- For qualified contractor maintenance, please contact the dealer where you bought the air conditioner.

Troubleshooting

Before making an inquiry or a request for repair, please check the following.
If the problem persists, consult your dealer.



Not a problem

This case is not a problem.



Check

Please check again before requesting repairs.

| Case | Description / what to check |
|---|--|
| Operation does not start soon. <ul style="list-style-type: none"> When ON/OFF button was pressed soon after operation was stopped. When the mode was reselected. | <input checked="" type="checkbox"/> <ul style="list-style-type: none"> This is to protect the air conditioner. You should wait for about 3 minutes. |
| Air does not come out. | <input checked="" type="checkbox"/> <ul style="list-style-type: none"> In HEAT operation <ul style="list-style-type: none"> The air conditioner is warming up. Wait for about 1 to 4 minutes. During defrosting operation, hot air does not flow out of the indoor unit. When the air conditioner operates immediately after the circuit breaker is turned on <ul style="list-style-type: none"> The air conditioner is preparing to operate. Wait for about 3 to 20 minutes. |
| The heating operation stops suddenly and a flowing sound is heard. | <input checked="" type="checkbox"/> <ul style="list-style-type: none"> The system is taking away the frost on the outdoor unit. You should wait for about 4 to 12 minutes. |
| The outdoor unit emits water or steam. | <input checked="" type="checkbox"/> <ul style="list-style-type: none"> In HEAT mode <ul style="list-style-type: none"> The frost on the outdoor unit melts into water or steam when the air conditioner is in defrost operation. In COOL or DRY mode <ul style="list-style-type: none"> Moisture in the air condenses into water on the cool surface of outdoor unit piping and drips. |
| Mist comes out of the indoor unit. | <input checked="" type="checkbox"/> <ul style="list-style-type: none"> This happens when the air in the room is cooled into mist by the cold air flow during cooling operation. |
| The indoor unit gives out odour. | <input checked="" type="checkbox"/> <ul style="list-style-type: none"> This happens when smells of the room, furniture, or cigarettes are absorbed into the unit and discharged with the air flow. (If this happens, we recommend you to have the indoor unit washed by a technician. Consult the service shop where you bought the air conditioner.) |
| The outdoor fan rotates while the air conditioner is not in operation. | <input checked="" type="checkbox"/> <ul style="list-style-type: none"> After operation is stopped: <ul style="list-style-type: none"> The outdoor fan continues rotating for another 30 seconds for system protection. While the air conditioner is not in operation: <ul style="list-style-type: none"> When the outdoor temperature is very high, the outdoor fan starts rotating for system protection. |
| The operation stopped suddenly. (OPERATION lamp is on.) | <input checked="" type="checkbox"/> <ul style="list-style-type: none"> For system protection, the air conditioner may stop operating on a sudden large voltage fluctuation. It automatically resumes operation in about 3 minutes. |
| The air conditioner does not operate. (OPERATION lamp is off.) | <input type="checkbox"/> <ul style="list-style-type: none"> Hasn't a breaker turned OFF or a fuse blown? Isn't it a power failure? Are batteries set in the remote controller? Is the timer setting correct? |
| Cooling (Heating) effect is poor. | <input type="checkbox"/> <ul style="list-style-type: none"> Are the air filters clean? Is there anything blocking the air inlet or the outlet of the indoor and the outdoor units? Is the temperature setting appropriate? Are the windows and doors closed? Are the air flow rate and the air direction set appropriately? |
| Operation stops suddenly. (OPERATION lamp flashes.) | <input type="checkbox"/> <ul style="list-style-type: none"> Are the air filters clean? Is there anything blocking the air inlet or the outlet of the indoor and the outdoor units? Clean the air filters or take all obstacles away and turn the breaker OFF. Then turn it ON again and try operating the air conditioner with the remote controller. If the lamp still blinks, call the service shop where you bought the air conditioner. Are operation modes all the same for indoor units connected to outdoor units in the multi system? If not, set all indoor units to the same operation mode and confirm that the lamps blink. Moreover, when the operation mode is in "AUTO", set all indoor unit operation modes to "COOL" or "HEAT" for a moment and check again that the lamps are normal. If the lamps stop blinking after the above steps, there is no malfunction. |

Troubleshooting

| Case | Description / what to check |
|--|---|
| An abnormal functioning happens during operation. |  • The air conditioner may malfunction with lightning or radio waves. Turn the breaker OFF, turn it ON again and try operating the air conditioner with the remote controller. |

Notes on the operating conditions

- If operation continues under any conditions other than those listed in the table,
 - A safety device may activate to stop the operation.
 - Dew may form on the indoor unit and drip from it when COOL or DRY operation is selected.

| Mode | Operating conditions |
|-------------------|--|
| COOL / DRY | Outdoor temperature: [HEAT PUMP model]: –10.0-46.0°C [COOLING ONLY model]: 10.0-46.0°C Indoor temperature: 18.0-32.0°C Indoor humidity: 80% max. |
| HEAT | Outdoor temperature: –15-24°C Indoor temperature: 10-30°C |

■ Call your dealer immediately

WARNING

When an abnormality (such as a burning smell) occurs, stop operation and turn off the circuit breaker.

- Continued operation in an abnormal condition may result in problems, electric shock or fire.
- Consult the dealer where you bought the air conditioner.

Do not attempt to repair or modify the air conditioner by yourself.

- Incorrect work may result in electric shock or fire.
- Consult the dealer where you bought the air conditioner.

If one of the following symptoms takes place, call your dealer immediately.

- The power cord is abnormally hot or damaged.
- An abnormal sound is heard during operation.
- The circuit breaker, a fuse, or the earth leakage circuit breaker cuts off the operation frequently.
- A switch or a button often fails to work properly.
- There is a burning smell.
- Water leaks from the indoor unit.

Turn off the circuit breaker and call your dealer.



■ After a power failure

- The air conditioner automatically resumes operation in about 3 minutes. You should just wait for a while.

■ Lightning

- If there is a risk lightning could strike in the neighbourhood, stop operation and turn off the circuit breaker to protect the system.

■ Disposal requirements

- Dismantling of the unit, handling of the refrigerant, oil and other parts, should be done in accordance with the relevant local and national regulations.

Memo

Memo

DAIKIN INDUSTRIES, LTD.

Head office:

Umeda Center Bldg., 2-4-12, Nakazaki-Nishi,
Kita-ku, Osaka, 530-8323 Japan

Tokyo office:

JR Shinagawa East Bldg., 2-18-1, Konan,
Minato-ku, Tokyo, 108-0075 Japan
<http://www.daikin.com>



The two-dimensional bar code is
a manufacturing code.

3P472684-7 M16B254 (1708) HT

DAIKIN

WIRELESS REMOTE CONTROLLER KIT

OPERATION MANUAL

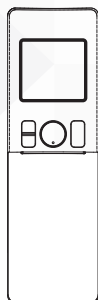

MODELS

BRC086A21

BRC086A22

Fig. 1-1

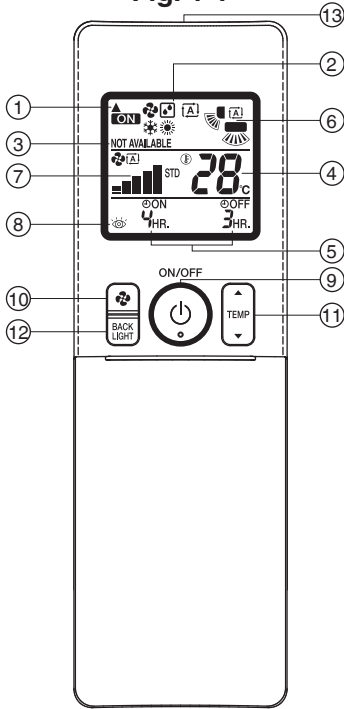

Fig. 1-2

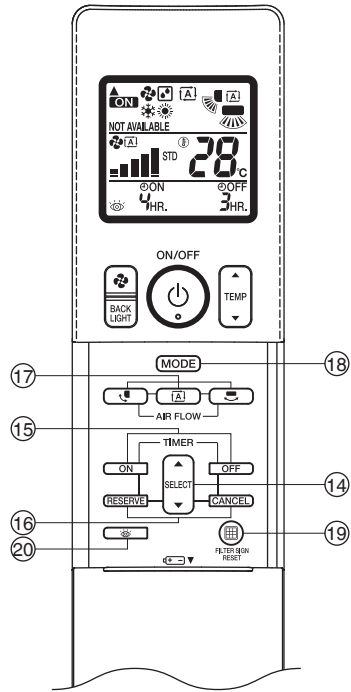
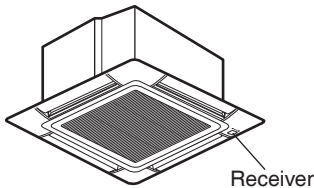
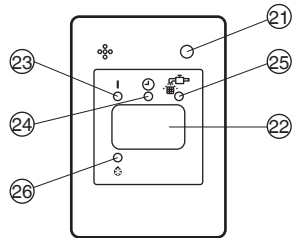

Fig. 2

CEILING MOUNTED CASSETTE TYPE (2x2)
(Sold separately)







SIGNAL RECEIVER UNIT SEPARATE TYPE
(Sold separately)



ACCESSORIES

Check if the following accessories are attached to this kit.

| | | | |
|----------|---|---|---|
| Name | (1) Wireless remote controller | (2) Remote controller holder | (3) Dry cell battery AAA. LR03 (alkaline) |
| Quantity | 1 | 1 | 2 |
| Shape |  |  |  |

| | | |
|----------|---|---|
| Name | (4) Operation manual | (5) Remote controller holder fixing screw M3 × 20L |
| Quantity | 1 | 2 |
| Shape |  |  |

PRIOR TO USE



This operation manual is exclusively for instructions on how to use the wireless remote controller. Read also the operation manual attached to the indoor unit and to the outdoor unit for safe usage of the system and maintenance.



CONTENTS

| | |
|---|--|
| ILLUSTRATIONS.....[1] | 6. INSTALLATION SITE.....5 |
| ACCESSORIES.....[2] | 7. OPERATION PROCEDURE.....5 |
| PRIOR TO USE.....1 | 8. OPERATION CHARACTERISTICS.....11 |
| 1. SAFETY PRECAUTIONS.....1 | 9. OPTIMUM OPERATION.....11 |
| 2. WHAT TO DO BEFORE OPERATION.....3 | 10. MAINTENANCE (FOR SERVICE PERSONNEL).....11 |
| 3. NAMES AND FUNCTIONS OF THE OPERATING SECTION (Refer to Fig. 1-1, 1-2, 2 on page [1]).....3 | 11. NOT MALFUNCTION OF THE AIR CONDITIONER.....11 |
| 4. HANDLING FOR WIRELESS REMOTE CONTROLLER.....4 | 12. HOW TO DIAGNOSE TROUBLE SPOTS.....11 |
| 5. OPERATION RANGE.....5 | 13. HOW TO CHECK THE INITIAL SET VALUE.....13 |

1. SAFETY PRECAUTIONS

- Keep this manual where the user can easily find it.
- The precautions described herein are classified as **WARNING** and **CAUTION**. They both contain important information regarding safety. Be sure to observe all precautions without fail.

| | |
|--|--|
|  WARNING |  CAUTION |
| Failure to follow these instructions properly may result in personal injury or loss of life. | Failure to follow these instructions properly may result in property damage or personal injury, which may be serious depending on the circumstances. |

| | | |
|---|---|---|
|  Never attempt. |  Be sure to follow the instructions. |  Be sure to establish an earth connection. |
|---|---|---|

- After reading, keep this manual in a convenient place so that you can refer to it whenever necessary. If the equipment is transferred to a new user, be sure also to hand over the manual.

WARNING



- Do not use means to accelerate the defrosting process or to clean, other than those recommended by the manufacturer.
- The appliance must be stored in a room without continuously operating ignition sources (for example: open flames, an operating gas appliance or an operating electric heater).
- Do not pierce or burn.
- Be aware that refrigerants may not contain an odour.
- To avoid fire, explosion or injury, do not operate the unit when harmful gases (e.g. flammable or corrosive) are detected near the unit.
- Be aware that prolonged, direct exposure to cool or warm air from the air conditioner, or to air that is too cool or too warm, can be harmful to your physical condition and health.
- Do not place objects, including rods, your fingers, etc., in the air inlet or outlet. Product damage or personal injury may result due to contact with the air conditioner's high-speed fan blades.
- Do not attempt to repair, dismantle, reinstall or modify the air conditioner yourself as this may result in water leakage, electric shock or fire hazards.
- Do not use flammable spray near the air conditioner, or otherwise fire may result.
- Do not use a refrigerant other than the one indicated on the outdoor unit when installing, moving or repairing. Using other refrigerants may cause trouble or damage to the unit, and personal injury.
- To avoid electric shock, do not operate with wet hands.



WARNING



- Beware of fire in case of refrigerant leakage. If the air conditioner is not operating correctly, i.e. not generating cool or warm air, refrigerant leakage could be the cause. Consult your dealer for assistance. The refrigerant within the air conditioner is safe and normally does not leak. However, in the event of a leakage, contact with a naked burner, heater or cooker may result in generation of noxious gas. Do not use the air conditioner until a qualified service person confirms that the leakage has been repaired.
 - Do not attempt to install or repair the air conditioner yourself. Improper workmanship may result in water leakage, electric shock or fire hazards. Please contact your local dealer or qualified personnel for installation and maintenance work.
 - If the air conditioner is malfunctioning (giving off a burning odour, etc.), turn off power to the unit and contact your local dealer. Continued operation under such circumstances may result in a failure, electric shock or fire hazards.
 - Be sure to install an earth leakage circuit breaker. Failure to install an earth leakage circuit breaker may result in electric shock or fire.
-
- Be sure to earth the unit. Do not earth the unit to a utility pipe, lightning conductor or telephone earth lead. Imperfect earthing may result in electric shock.



CAUTION



















- Do not use the air conditioner for purposes other than those for which it is intended. Do not use the air conditioner for cooling precision instruments, food, plants, animals or works of art as this may adversely affect the performance, quality and/or longevity of the object concerned.
 - Do not expose plants or animals directly to the airflow from the unit as this may cause adverse effects.
 - Do not place appliances that produce naked flames in places exposed to the airflow from the unit as this may impair combustion of the burner.
 - Do not block the air inlets nor outlets. Impaired airflow may result in insufficient performance or trouble.
 - Do not sit on the outdoor unit, put things on the unit, or pull the unit. Doing so may cause accidents, such as falling or toppling down, thus resulting in injury, product malfunctioning, or product damage.
 - Do not place objects that are susceptible to moisture directly beneath the indoor or outdoor units. Under certain conditions, condensation on the main unit or refrigerant pipes, air filter dirt or drain blockage may cause dripping, resulting in fouling or failure of the object concerned.
 - After prolonged use, check the unit stand and its mounts for damage. If they are left in a damaged condition, the unit may fall and cause injury.
 - To avoid injury, do not touch the air inlet or aluminium fins of the indoor or outdoor units.
 - The appliance is not intended for use by unattended young children or infirm persons. Impairment of bodily functions and harm to health may result.
 - Children should be supervised to ensure that they do not play with the unit or its remote controller. Accidental operation by a child may result in impairment of bodily functions and harm health.
 - Avoid impacts to the indoor and outdoor units, or otherwise product damage may result.
 - Do not place flammable items, such as spray cans, within 1m of the air outlet.
The spray cans may explode as a result of hot air from the indoor or outdoor units.
 - Be careful not to let pets urinate on the air conditioner. Urination on the air conditioner may result in electric shock or fire.
 - Do not wash the air conditioner with water, as this may result in electric shock or fire.
 - Do not place water containers (vases, etc.) above the unit, as this may result in electric shock or fire hazards if they should topple over.
 - Do not insert the batteries in the wrong polarity (+/-) orientation as this may result in short circuiting, fire, or battery leakage.
-
- To avoid oxygen depletion, ensure that the room is adequately ventilated if equipment such as a burner is used together with the air conditioner.
 - Before cleaning, be sure to stop unit operation and turn off the circuit breaker. Otherwise, an electric shock and injury may result.
 - Only connect the air conditioner to the specified power supply circuit. Power supplies other than the one specified may result in electric shock, overheating and fires.
 - Arrange the drain hose to ensure smooth drainage. Imperfect drainage may cause wetting of the building, furniture, etc.
 - Do not place objects in direct proximity of the outdoor unit and do not let leaves and other debris accumulate around the unit. Leaves are a hotbed for small animals which can enter the unit. Once inside the unit, such animals can cause malfunctions, smoke or fire if they come into contact with electrical parts.
 - Do not place objects around the indoor unit.
Doing so may have an adverse influence on the performance, product quality, and life of the air conditioner.
 - This appliance is not intended to be used by persons with reduced physical, sensory or mental capabilities, or with lack of operation knowledge, unless they have been given supervision or instruction concerning the appliance use by person responsible for their safety. Keep out of children's reach to ensure that they do not play with the appliance.

2. WHAT TO DO BEFORE OPERATION

Refer to the operation manual attached to the indoor unit.

3. NAMES AND FUNCTIONS OF THE OPERATING SECTION (Refer to Fig. 1-1, 1-2, 2 on page [1])

| | |
|----|---|
| 1 | DISPLAY “▲” (SIGNAL TRANSMISSION) This blinks when a signal is being transmitted. |
| 2 | DISPLAY “ “ “ “ “ ” (OPERATION MODE) This display shows the current OPERATION MODE. Operation modes supported depend on the model that is connected. |
| 3 | DISPLAY “NOT AVAILABLE” (displayed when operation is not supported) When a button for a function that is not supported on the connected model is pressed, this displays for 2 seconds. |
| 4 | DISPLAY “ 28.0 °C ” (SET TEMPERATURE) This display shows the set temperature. |
| 5 | DISPLAY “ ON ” / “ OFF ” (PROGRAMMED TIME) This display shows PROGRAMMED TIME of the air conditioner start or stop. |
| 6 | DISPLAY “ ” (AIRFLOW BLADE) Refer to page 8, 9. |
| 7 | DISPLAY “ ” (FAN SPEED) The display shows the set fan speed. |
| 8 | DISPLAY “ ” (INSPECTION) When the INSPECTION BUTTON is pressed, the display shows the system mode is in. Do not operate this button during normal use. |
| 9 | ON/OFF BUTTON Press the button and the air conditioner will start. Press the button again and the air conditioner will stop. |
| 10 | FAN SPEED CONTROL BUTTON Press this button to select the fan speed. |
| 11 | TEMPERATURE SETTING BUTTON Use this button for SETTING TEMPERATURE. |
| 12 | BACKLIGHT BUTTON Press this button to turn the backlight on or off. |
| 13 | SIGNAL TRANSMITTER This sends the signals to the indoor unit. |

| | |
|----|--|
| | PROGRAMMING TIMER BUTTON |
| 14 | Use this button for programming “START and/ or STOP” time. |
| | TIMER MODE ON/OFF BUTTON |
| 15 | Refer to page 9. |
| | TIMER RESERVE/CANCEL BUTTON |
| 16 | Refer to page 9. |
| | AIRFLOW DIRECTION ADJUST BUTTON |
| 17 | Refer to page 8. |
| | OPERATION MODE SELECTOR BUTTON Press this button to select OPERATION MODE. |
| 18 | “  ” (COOLING), “  ” (HEATING), “  ” (AUTOMATIC), “  ” (FAN), “  ” (PROGRAMME DRY). |
| | FILTER SIGN RESET BUTTON |
| 19 | Refer to the section of MAINTENANCE in the operation manual attached to the indoor unit. |
| | INSPECTION BUTTON |
| 20 | This button is used only by qualified service persons for maintenance purposes. Do not operate this button during normal use. |
| | EMERGENCY OPERATION SWITCH |
| 21 | This switch is readily used if the remote controller does not work. |
| | RECEIVER |
| 22 | This receives the signals from the remote controller. |
| | OPERATING INDICATOR LAMP (Red) |
| 23 | This lamp stays lit while the air conditioner runs. It flashes when the air conditioner is in trouble. |
| | TIMER INDICATOR LAMP (Green) |
| 24 | This lamp stays lit while the timer is set. |
| | AIR FILTER CLEANING TIME INDICATOR LAMP (Red) |
| 25 | Lights up when it is time to clean the air filter. |
| | DEFROST OPERATION LAMP (Orange) |
| 26 | Lights up when the defrosting operation has started. |

NOTE 

- For the sake of explanation, all indications are shown on the display in **Fig. 1** contrary to actual running situations.
- **Fig. 1-2** shows the remote controller with the front cover opened.
- If the AIR FILTER CLEANING TIME INDICATOR LAMP lights up, clean the air filter as explained in the operation manual attached to the indoor unit.
- After cleaning and reinstalling the air filter, press the FILTER SIGN RESET BUTTON on the remote controller. The AIR FILTER CLEANING TIME INDICATOR LAMP on the receiver will go out.
- The DEFROST OPERATION LAMP will flash when the power is turned on. This is not a malfunction.
- Do not place the remote controller where subject to direct sunlight. The display of the remote controller will get discolored and may fail to display information.

[CAUTIONS]

Make sure to turn off the unit and disconnect the power supply circuit breaker when taking care of the air conditioner.

Unless the power supply is disconnected, it may cause electric shock and injuries.

4. HANDLING FOR WIRELESS REMOTE CONTROLLER

[Precautions in handling remote controller]
Direct the transmitting part of the remote controller to the receiving part of the air conditioner.

If something blocks the transmitting and receiving path of the indoor unit and the remote controller as curtains, it will not operate.

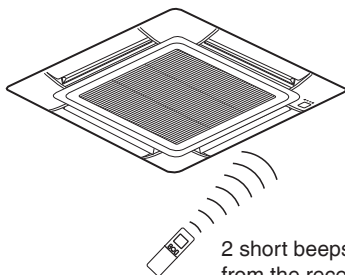

2 short beeps from the receiver indicates that the transmission is properly done.

Types of receiving tone

The following receiving tones sound when remote controller signals are detected by the receiver.

2 SHORT BEEPS:

Signal from the remote controller was received successfully.

1 LONG BEEP:

(Error tone) The selected function is not supported on this indoor unit.

3 SHORT BEEPS:

(Error tone) Setting/change cannot be made using this remote controller as centralised control is in operation.

NOTE 

- After settings are changed or operation is turned ON/OFF, make sure that the receiving tone of the indoor unit makes a beeping sound.

The maximum transmitting distance is 7 to 9m.

This depends on the installation condition of the indoor unit.

Do not drop or get it wet.

It may be damaged.

Never press the button of the remote controller with a hard, pointed object.

The remote controller may be damaged.

Installation site

- It is possible that signals will not be received in rooms that have electronic fluorescent lighting. Please consult with your local dealer before buying new fluorescent lights.
- If the remote controller operated some other electrical apparatus, move that machine away or consult your local dealer.
- Do not install the remote controller in places exposed to direct sunlight. Doing so could result in discolouration and failure of the LCD.

[CAUTIONS]

Incorrect handling of batteries can result in injury from battery leakage, rupturing or heating, or lead to equipment failure.

Please observe the following precautions and use safely.

- If the alkaline solution from the batteries should get in the eyes, do not rub the eyes. Instead, immediately flush the eyes with tap water and seek the attention of a medical professional.
- Keep batteries out of reach of children. In the event that batteries are swallowed, seek the immediate attention of a medical professional.
- Do not expose batteries to heat or fire. Do not disassemble or modify batteries. The insulation or gas release vent inside the battery may be damaged, resulting in battery leakage, rupturing, or heating.
- Do not damage or peel off labels on the batteries.

To insert the batteries

Position ⊕ and ⊖ correctly!

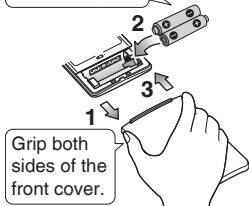

To attach the remote controller holder to a wall

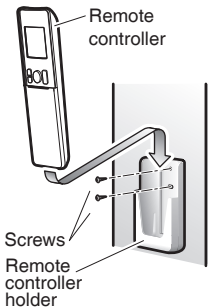

1. Slide the front cover to take it off.
2. Insert 2 dry batteries AAA. LR03 (alkaline).
3. Replace the front cover.

1. Choose a place from where the signals reach the unit.
2. Attach the holder to a wall, a pillar, or similar location with the screws supplied with the holder.
3. Place the remote controller in the remote controller holder.

NOTE

Notes on batteries

- To avoid possible injury or damage from battery leakage or rupturing, remove the batteries when not using the product for long periods of time.
- The standard replacement time is about 1 year. Both batteries should be replaced at the same time. Be sure to replace them with new size AAA.LR03 (alkaline) batteries.
- The batteries supplied with the remote controller are for initial operation. The batteries may run out in less than 1 year.

[CAUTIONS]

- **Replace all batteries at the same time, do not use new and old batteries intermixed.**
- **In case the remote controller is not used for a long time take out all batteries in order to prevent liquid leak of the battery.**

IN THE CASE OF CENTRALIZED CONTROL SYSTEM

If the indoor unit is under centralized control, it is necessary to switch the remote controller's setting.

In this case, contact your local dealer.

5. OPERATION RANGE

If the temperature or the humidity is beyond the operation range*, safety devices may work and the air conditioner may not operate, or sometimes, water may drop from the indoor unit.

*Refer to the operation range shown in the operation manual attached to the indoor or outdoor unit.

6. INSTALLATION SITE

Refer to operation manual attached to the indoor unit.

7. OPERATION PROCEDURE

- Operation procedure varies with heat pump type and cooling only type. Contact your local dealer to confirm your system type.
- To protect the unit, turn on the main power switch 6 hours before operation.
- Do not shut off the power supply during seasonal use of the air conditioner. This is required in order to activate the air conditioner smoothly.
- If the main power supply is turned off during operation, operation will restart automatically after the power turns back on again.

COOLING, HEATING, AUTOMATIC, FAN, AND DRY OPERATION

Operate in the following order.

- Operation modes supported depend on the model that is connected.
- For cooling only type, "COOLING", and "FAN" and "DRY" operation are able to select.

FOR SYSTEMS WITHOUT COOL/HEAT CHANGEOVER REMOTE CONTROL SWITCH

Refer to Fig. 1-2 on page [1]



OPERATION MODE SELECTOR

Press **OPERATION MODE SELECTOR** button several times and select the **OPERATION MODE** of your choice as follows.

- **COOLING OPERATION** "❄️"
The recommended set temperature is 26 to 28°C.
- **HEATING OPERATION** "🔥"
The recommended set temperature is 18 to 23°C.
- **AUTOMATIC OPERATION** "🏠"
 - In this operation mode, COOLING/HEATING changeover is automatically conducted.
 - AUTOMATIC OPERATION controls the temperature based on the set temperature, so it maintains a comfortable temperature throughout the year.
<Example>
When the indoor temperature decreases to 23°C or less when the set temperature is at 25°C in the AUTOMATIC COOLING OPERATION, the operation is changed over to the AUTOMATIC HEATING OPERATION. When the indoor temperature reaches 27°C or more, the operation is changed over to the AUTOMATIC COOLING OPERATION.
- **FAN OPERATION** "🌀"
Air in the room is circulated.
- **DRY OPERATION** "📺"
 - This operation is to decrease the humidity in your room with the minimum temperature decrease.
 - The set point is the air temperature when starting operation by DRY operation.
 - Micro computer automatically determines TEMPERATURE and FAN SPEED.
 - DRY operation will not activate when room temperature is 16°C or less.

2



ON/OFF

Press **ON/OFF** button.

OPERATING INDICATOR LAMP (Red) lights up or goes off and the system starts or stops OPERATION.

- The fan may keep on running for about 1 minute after the heating operation stops for removing the heat in the indoor unit.

NOTE 📌

- Do not turn OFF power immediately after the unit stops. Then, wait no less than 5 minutes. Water is leaking or there is something else wrong with the unit.

■ CHARACTERISTICS OF THE COOLING OPERATION (COOLING OPERATION AND AUTOMATIC COOLING OPERATION)

- After continuous operation with the airflow horizontally or downward, the air conditioner operates with different airflow direction for a certain period of time to prevent condensation build-up on the airflow direction blades. (The remote controller displays the airflow direction that is set.)
- If the COOLING OPERATION is used when the indoor temperature is low, frost adheres to the heat exchanger of the indoor unit. This can decrease the cooling capacity. In this case, the system automatically switches to DEFROST OPERATION for a while.
During DEFROST OPERATION, the low fan speed is used to prevent the discharge of melt water. (The remote controller displays the fan speed that is set.)
- When the outside temperature is high, it takes some time until the indoor temperature reaches the set temperature.

■ CHARACTERISTICS OF THE HEATING OPERATION (HEATING OPERATION AND AUTOMATIC HEATING OPERATION)

START OF OPERATION

- It generally takes a longer time for indoor temperature of the HEATING OPERATION to reach the set temperature compared to the COOLING OPERATION. It is advisable to start operation in advance using the TIMER OPERATION.

After operation is stopped

- The fan operates for about 1 minute to dispel heat inside the indoor unit.

Perform the following operation to prevent heating capacity decrease and discharge of cool air.

AT THE START OF OPERATION AND AFTER DEFROST OPERATION

- A warm air circulating system is employed, and therefore it takes some time until the entire room is warmed up after the start of operation.
- The indoor fan runs to discharge a gentle wind automatically until the temperature inside the air conditioner reaches a certain level. At this time, the DEFROST OPERATION LAMP on the light receiving unit indicator lights. Leave it as it stands and wait for a while.
(The remote controller displays the fan speed that is set.)
- The air discharge direction becomes horizontal to prevent a draft of cool air to the inhabitants.
(The remote controller will display the set airflow direction.)

DEFROST OPERATION (Frost removal operation for the outdoor unit)

- As the frost on the coil of an outdoor unit increase, heating effect decreases and the system goes into the DEFROST OPERATION.
- The warm air stops, and the DEFROST OPERATION LAMP on the light receiving unit turn on. (The remote controller displays the fan speed that is set.)
- After maximum 10 minutes of the DEFROST OPERATION, the air conditioner returns to the HEATING OPERATION.
- The airflow direction becomes horizontal. (The remote controller displays the airflow direction that is set.)
- During or after the DEFROST OPERATION, white mist comes out from the air inlet or outlet of the air conditioner.
- A hissing and “Shuh” sound may be heard during this particular operation.

Regarding outside air temperature and heating capacity

- The heating capacity of the air conditioner declines as the outside air temperature falls. In such a case, use the air conditioner in combination with other heating systems. (When a combustion appliance is used, ventilate the room regularly.)
Do not use the combustion appliance where the air from the air conditioner is blown directly toward it.
- When the warm air stays under the ceiling and your feet are cold, we recommend that you use a circulator (a fan to circulate the air inside the room). For details, consult your local dealer.
- When the indoor temperature exceeds the set temperature, the indoor unit discharges a gentle breeze (switches to gentle wind). The airflow direction becomes horizontal. (The remote controller displays the fan speed and airflow direction that are set.)

FAN OPERATION

- Only the fan inside the indoor unit operates, and the air in the room is circulated.

■ CHARACTERISTICS OF THE DRY OPERATION

- This operation lowers the humidity without lowering the indoor temperature. The indoor temperature when the operation button is pressed will be the set temperature. At this time, the fan speed and temperature are set automatically, so the remote controller does not display the fan speed and set temperature. To efficiently lower the indoor temperature and humidity, first use the COOLING OPERATION to lower the indoor temperature, and then use the DRY OPERATION. When the indoor temperature is lowered, airflow from the indoor unit may stop.
- When operating continuously at downward airflow direction, air blows in the automatically set direction for a period of time to prevent condensation on the horizontal blades.
- If the DRY OPERATION is used when the indoor temperature is low, frost forms on the heat exchanger of the indoor unit. In this case, the system automatically switches to the DEFROST OPERATION for a while.

ADJUSTMENT

For programming TEMPERATURE, FAN SPEED and AIRFLOW DIRECTION, follow the procedure shown below.

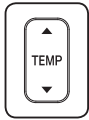

TEMPERATURE SETTING

Press TEMPERATURE SETTING button and programme the set temperature.

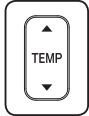

Each time this button is pressed, set temperature rises 1°C.

Each time this button is pressed, set temperature lowers 1°C.

- Temperature cannot be set in FAN OPERATION and DRY OPERATION modes.

In case of AUTOMATIC OPERATION

- In AUTOMATIC OPERATION mode, the relative temperature as compared to the standard set temperature is displayed.

| Remote controller display | Set temperature [°C] |
|---------------------------|----------------------|
| STD -3 | 19 |
| STD -2 | 20 |
| STD -1 | 21 |
| STD | 22 |
| STD +1 | 23 |
| STD +2 | 24 |
| STD +3 | 25 |

NOTE

- The set temperature range of the remote controller is 16°C to 32°C.



FAN SPEED CONTROL

Press FAN SPEED CONTROL button.

Fan speed can be selected.

- The micro computer may sometimes control the fan speed in order to protect the unit.
- The fan speed may be changed automatically depending on the indoor temperature. The fan may be stopped, but this is normal.
- It may take some time until the airflow switch is completed, but this is normal.
- Fan speeds supported depend on the model that is connected.
- In “ [A]” (Auto), the fan speed is adjusted according to the set temperature and the temperature in the room. However, in FAN OPERATION mode, fan speed is fixed.

- The fan speed will not be displayed if the indoor unit does not have fan speed control function.



UP AND DOWN AIRFLOW DIRECTION ADJUSTMENT

The up/down airflow direction position switches each time the up/down airflow direction button is pressed.

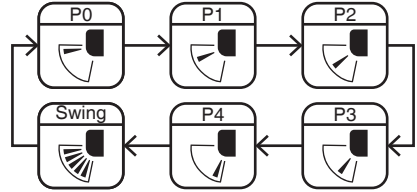

Movement of the airflow direction blades

Under the operating conditions described below, airflow direction is controlled automatically, so it may differ from the airflow direction displayed on the remote controller.

| | | |
|----------------------|--|--|
| Operating conditions | When the room temperature is higher than the set temperature (for HEATING OPERATION) | The air is blown horizontally so that the airflow is not directed at the body. |
| | When HEATING OPERATION starts and when in DEFROST OPERATION mode (for HEATING OPERATION) | The air is blown horizontally so that the cold airflow is not directed at the body. |
| | During continuous operation with the air blowing downward or horizontally | The air conditioner operates with a different airflow direction for a certain period of time to prevent condensation build-up on the airflow direction blades. |

- * HEATING OPERATION mode includes cases in which operation is set to “ [A]”.

Description of airflow direction settings and operation

The range of movement of the airflow direction blades varies by indoor unit model. Consult the dealer of purchase for details.

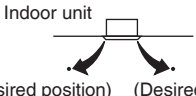
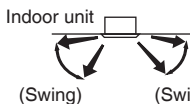
| | |
|----------------------------|---|
| Airflow direction settings | <ul style="list-style-type: none"> ■ Ceiling Mounted Cassette (Round Flow, 4-way Flow, 2-way Flow) ■ 4-Way Blow Ceiling Suspended |
| | Up/down airflow |
| Fixed | <p>The airflow direction can be fixed in any position in the range Position 0 to Position 4.</p> <div style="text-align: center;">  <p>Indoor unit</p> <p>(Desired position) (Desired position)</p> </div> |
| Swing | <p>The airflow direction blades automatically move up and down within the range of Position 0 to Position 4.</p> <div style="text-align: center;">  <p>Indoor unit</p> <p>(Swing) (Swing)</p> </div> |
| Automatic | <p>The airflow direction changes automatically according to the temperature of the room. However, during FAN OPERATION, the airflow direction is set to Position 0. * Depending on the model, it may not be possible to use this function.</p> |

PROGRAMME TIMER OPERATION

Operate in the following order.

- The timer is operated in the following 2 ways. Programming the stop time (⊖ OFF)
.... The air conditioner stops operating after the set time has elapsed.
Programming the start time (⊕ ON)
.... The air conditioner starts operating after the set time has elapsed.
- The start and the stop time can be simultaneously programmed.
- The timer setting is effective only once. When using the TIMER operation every day, the setting is required before each use.

Setting the timer

1 TIMER MODE ON/OFF

Press the **TIMER MODE ON/OFF** button.

The display flashes.

For setting the timer stop "⊖ OFF"

For setting the timer start "⊕ ON"

2



PROGRAMMING TIMER

Press the **PROGRAMMING TIMER** button and set the time for stopping or starting the air conditioner.

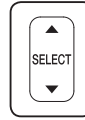

When this button is pressed, the time advances by 1 hour.

When this button is pressed, the time goes backward by 1 hour.

- Keep pressing the button to change the setting time continuously.
- The timer can be programmed a maximum of 72 hours.

3



TIMER RESERVE

Press the **TIMER RESERVE** button.

The timer setting procedure ends.

The display changes from flashing light to a constant light.

- Make sure that the receiving tone of the indoor unit makes a beeping sound. If the receiving tone does not sound, cancel the timer according to the steps below, and then set the timer following steps ① to ③ above again.

Cancelling the timer

1



ON/OFF TIMER

When the on **TIMER MODE ON/OFF** button is pressed, the screen display flashes as described below.

For the off timer "⊖ OFF"

For the on timer "⊕ ON"

2



TIMER CANCEL

When the **TIMER CANCEL** button is pressed, the timer setting that is blinking is cancelled.

- Check that the indoor unit's receiving tone beeps twice. If the receiving tone does not sound, select the timer you want to cancel again, and then cancel it.

For example.

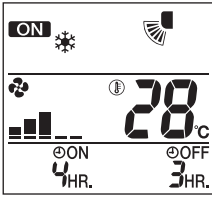

When the timer is programmed to stop the system after 3 hours and start the air conditioner after 4 hours, the air conditioner will stop after 3 hours and then 1 hour later the air conditioner will start.

NOTE

- After the timer is programmed, the display shows the remaining time.

EMERGENCY OPERATION

When the remote controller does not work due to battery failure or the absence thereof, use the switch on the receiver of the indoor unit. When the remote controller does not work, even if the batteries are replaced, contact your local dealer.

[START]

1 Press the **EMERGENCY OPERATION SWITCH** on the receiver.

- The air conditioner operates in the previous mode.
- The air conditioner operates with the previously set fan speed.

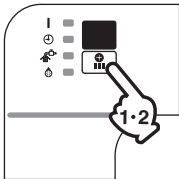

Location of this display varies by model. (Refer to Fig. 2 on page [1])

[STOP]

2 Press the **EMERGENCY OPERATION SWITCH** again.

PRECAUTIONS FOR 2 REMOTE CONTROLLER CONTROL SYSTEM

This system provides 2 other control systems beside individual control (1 remote controller controls 1 indoor unit) system. Confirm the following if your system is of the following control system type.

■ 2 remote controller control system

2 remote controllers (wired and wireless) control 1 indoor unit.

The air conditioner follows individual operation.

- Cannot have 2 remote controller control system with only wireless remote controllers. (It will be a 2 remote controller control system having 1 wired and 1 wireless remote controllers.)
- Under 2 remote controller control system, wireless remote controller cannot control timer operation.
- When set the timer by the wired remote controller, the **TIMER INDICATOR LAMP (Green)** of the receiver of the indoor unit is not light up.
- If the wired remote controller is used for operation, the display on the wireless remote controller does not change.

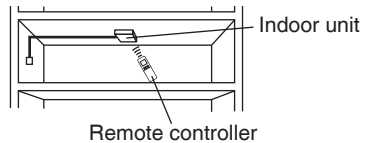

NOTE

- Contact your local dealer in case of changing the combination or setting of 2 remote controller control systems.
- Please do not change the combination and settings for the 2 remote controller control systems by yourself, but be sure to ask your local dealer.

8. OPERATION CHARACTERISTICS

Refer to the operation manual attached to the indoor unit.

9. OPTIMUM OPERATION

Refer to the operation manual attached to the indoor unit.

10. MAINTENANCE (FOR SERVICE PERSONNEL)

Refer to the operation manual attached to the indoor unit.

11. NOT MALFUNCTION OF THE AIR CONDITIONER

Refer to the operation manual attached to the indoor unit.

And the following symptoms do not indicate air conditioner malfunction

I. THE AIR CONDITIONER DOES NOT OPERATE

- **The receiving tone of the indoor unit makes a triple beeping sound (normally, “beep-beep”).**

This is because the air conditioner is under centralized control.

- **After the HEATING OPERATION is started, the DEFROST OPERATION LAMP located on the indoor unit lights up.**

The indoor fan runs to discharge a gentle wind automatically until the temperature inside the air conditioner reaches a certain level. At this time, the DEFROST OPERATION LAMP on the light receiving unit indicator lights. Leave it as it stands and wait for a while.

II. COOLING AND HEATING OPERATIONS CAN NOT BE SWITCHED

- **The receiving tone of the indoor unit makes a long beeping sound.**

An unavailable mode was set for the indoor unit under operation changeover control.

III. THERE IS NO DISPLAY OR ALL PARTS ARE DISPLAYED

- **When a button on the remote controller is pressed.**

The batteries have run out.

12. HOW TO DIAGNOSE TROUBLE SPOTS

I. IN CASE BESIDES EMERGENCY STOP

1. The air conditioner does not operate at all.

- Check if the receiver is exposed of sunlight or strong light. Keep receiver away from light.
- Check if there are batteries in the remote controller. Place the batteries.

2. The air conditioner operates but it does not sufficiently cool or heat.

- Check if the set temperature is not proper. (Refer to page 8)
- Check if the FAN SPEED is set to LOW SPEED. (Refer to page 8)
- Check if the airflow direction is not proper. (Refer to page 8, 9)

If the problem is not solved after checking the above points, please do not try to repair it yourself. In such cases, always consult your local dealer. At this time, please tell the symptom and model name (written on the manufacturer's label).

Contact your local dealer in the following case.



WARNING

When you detect a burning odour, shut OFF power immediately and contact your local dealer purchase. Using the equipment in anything but proper working condition can result in equipment damage, electric shock and/or a fire.

II. EMERGENCY STOP

When the air conditioner stops in emergency, the OPERATING INDICATOR LAMP on the indoor unit starts blinking. Take the following steps yourself to read the malfunction code that appears on the display. Contact your local dealer with this code. It will help pinpoint the cause of the trouble, speeding up the repair.

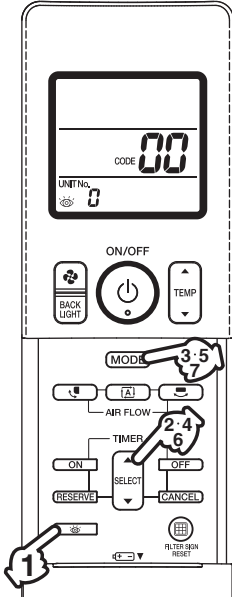

Press the **INSPECTION** button to select the inspection mode “”.

“” appears on display and blinks.
“UNIT No.” appears.



Press **PROGRAMMING TIMER** button and change the unit number.

Press to change the unit number until the indoor unit beeps and perform the following operation according to the number of beeps.

Number of beeps

3 short beeps..... Perform all steps from **3** to **6**.

1 short beep Perform **3** and **6** steps.

1 long beep Normal state



Press **OPERATION MODE SELECTOR** button.

“” on the left-hand of the malfunction code blinks.



Press **PROGRAMMING TIMER** button and change the malfunction code.

Press until the indoor unit beeps twice.



Press **OPERATION MODE SELECTOR** button.

“” on the right-hand of the malfunction code blinks.



Press **PROGRAMMING TIMER** button and change the malfunction code.

Press until the indoor unit makes a long beep. The malfunction code is fixed when the indoor unit makes a long beep.



Reset of the display

Press the **OPERATION MODE SELECTOR** button to get the display back to the normal state.

[Trouble]

The OPERATING INDICATOR LAMP of the indoor unit is flashing and the unit does not work at all. (Refer to page 3)

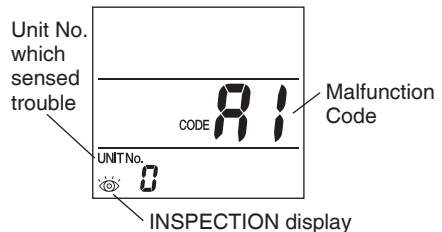

[Remedial action]

Check the malfunction code on the remote controller and contact your local dealer. (Refer to page 12)

13. HOW TO CHECK THE INITIAL SET VALUE

Further question regarding to the available functions, contact your local dealer with your initial setting value confirmed by using the remote controller with the following steps.



Press the **INSPECTION** button to select the inspection mode “”.

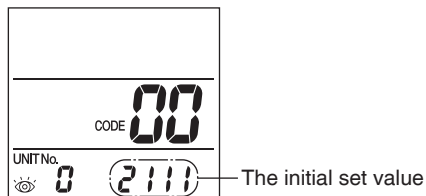

Press the  button **2 times** to return to normal operation mode.

DAIKIN INDUSTRIES, LTD.

Head office:
Umeda Center Bldg., 2-4-12, Nakazaki-Nishi,
Kita-ku, Osaka, 530-8323 Japan

Tokyo office:
JR Shinagawa East Bldg., 2-18-1, Konan,
Minato-ku, Tokyo, 108-0075 Japan
<http://www.daikin.com>



The two-dimensional bar code is
a manufacturing code.

3P477582-1

M16B306

(1707) HT