

**DAIKIN**

DAIKIN ROOM AIR CONDITIONER

# OPERATION MANUAL

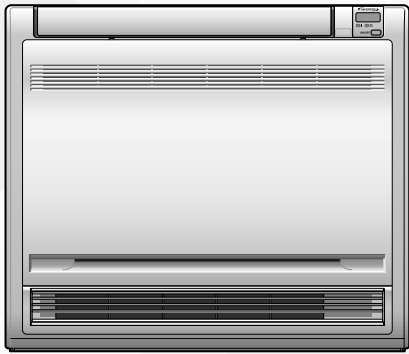

***INVERTER***

Enjoy year-round comfort.

## **MODELS**

**FVXS60LVMA  
FVXS71LVMA  
FVXS50RV1A**



# CONTENTS

## READ BEFORE OPERATION

Safety Precautions .....	2
Names of Parts .....	4
Preparation before Operation .....	8

## OPERATION

AUTO · DRY · COOL · HEAT · FAN Operation .....	10
Adjusting the Airflow Direction .....	12
POWERFUL Operation.....	14
OUTDOOR UNIT QUIET Operation .....	15
ECONO Operation.....	16
TIMER Operation.....	17
WEEKLY TIMER Operation .....	19

## CARE



Care and Cleaning.....	26
------------------------	----



## TROUBLESHOOTING

Troubleshooting .....	30
-----------------------	----

# Safety Precautions

- Keep this manual where the user can easily find it.
- Read the precautions in this manual carefully before operating the unit.
- The precautions described herein are classified as WARNING and CAUTION. They both contain important information regarding safety. Be sure to observe all precautions without fail.

 <b>WARNING</b>	 <b>CAUTION</b>
Failure to follow these instructions properly may result in personal injury or loss of life.	Failure to follow these instructions properly may result in property damage or personal injury, which may be serious depending on the circumstances.

 Never attempt.	 Be sure to follow the instructions.	 Be sure to establish an earth connection.
--	---	---

- After reading, keep this manual in a convenient place so that you can refer to it whenever necessary. If the equipment is transferred to a new user, be sure also to hand over the manual.

## **WARNING**



- To avoid fire, explosion or injury, do not operate the unit when harmful gases (e.g. flammable or corrosive) are detected near the unit.
- Be aware that prolonged, direct exposure to cool or warm air from the air conditioner, or to air that is too cool or too warm, can be harmful to your physical condition and health.
- Do not place objects, including rods, your fingers, etc., in the air inlet or outlet. Product damage or personal injury may result due to contact with the air conditioner's high-speed fan blades.
- Do not attempt to repair, dismantle, reinstall or modify the air conditioner yourself as this may result in water leakage, electric shock or fire hazards.
- Do not use flammable spray near the air conditioner, or otherwise fire may result.
- Do not use a refrigerant other than the one indicated on the outdoor unit (R410A) when installing, moving or repairing. Using other refrigerants may cause trouble or damage to the unit, and personal injury.
- To avoid electric shock, do not operate with wet hands.



- Beware of fire in case of refrigerant leakage. If the air conditioner is not operating correctly, i.e. not generating cool or warm air, refrigerant leakage could be the cause. Consult your dealer for assistance. The refrigerant within the air conditioner is safe and normally does not leak. However, in the event of a leakage, contact with a naked burner, heater or cooker may result in generation of noxious gas. Do not use the air conditioner until a qualified service person confirms that the leakage has been repaired.
- Do not attempt to install or repair the air conditioner yourself. Improper workmanship may result in water leakage, electric shock or fire hazards. Please contact your local dealer or qualified personnel for installation and maintenance work.
- If the air conditioner is malfunctioning (giving off a burning odour, etc.), turn off power to the unit and contact your local dealer. Continued operation under such circumstances may result in a failure, electric shock or fire hazards.
- Be sure to install an earth leakage circuit breaker. Failure to install an earth leakage circuit breaker may result in electric shock or fire.



- Be sure to earth the unit. Do not earth the unit to a utility pipe, lightning conductor or telephone earth lead. Imperfect earthing may result in electric shock.

## **CAUTION**



- Do not use the air conditioner for purposes other than those for which it is intended. Do not use the air conditioner for cooling precision instruments, food, plants, animals or works of art as this may adversely affect the performance, quality and/or longevity of the object concerned.
- Do not expose plants or animals directly to the airflow from the unit as this may cause adverse effects.
- Do not place appliances that produce naked flames in places exposed to the airflow from the unit as this may impair combustion of the burner.

## CAUTION



- Do not block the air inlets nor outlets. Impaired airflow may result in insufficient performance or trouble.
- Do not sit on the outdoor unit, put things on the unit, or pull the unit. Doing so may cause accidents, such as falling or toppling down, thus resulting in injury, product malfunctioning, or product damage.
- Do not place objects that are susceptible to moisture directly beneath the indoor or outdoor units. Under certain conditions, condensation on the main unit or refrigerant pipes, air filter dirt or drain blockage may cause dripping, resulting in fouling or failure of the object concerned.
- After prolonged use, check the unit stand and its mounts for damage. If they are left in a damaged condition, the unit may fall and cause injury.
- To avoid injury, do not touch the air inlet or aluminium fins of the indoor or outdoor units.
- The appliance is not intended for use by unattended young children or infirm persons. Impairment of bodily functions and harm to health may result.
- Children should be supervised to ensure that they do not play with the unit or its remote controller. Accidental operation by a child may result in impairment of bodily functions and harm health.
- Avoid impacts to the indoor and outdoor units, or otherwise product damage may result.
- Do not place flammable items, such as spray cans, within 1m of the air outlet.  
The spray cans may explode as a result of hot air from the indoor or outdoor units.
- Be careful not to let pets urinate on the air conditioner. Urination on the air conditioner may result in electric shock or fire.
- Do not wash the air conditioner with water, as this may result in electric shock or fire.
- Do not place water containers (vases, etc.) above the unit, as this may result in electric shock or fire hazards if they should topple over.
- Do not insert the batteries in the wrong polarity (+/-) orientation as this may result in short circuiting, fire, or battery leakage.



- To avoid oxygen depletion, ensure that the room is adequately ventilated if equipment such as a burner is used together with the air conditioner.
- Before cleaning, be sure to stop unit operation and turn off the circuit breaker. Otherwise, an electric shock and injury may result.
- Only connect the air conditioner to the specified power supply circuit. Power supplies other than the one specified may result in electric shock, overheating and fires.
- Arrange the drain hose to ensure smooth drainage. Imperfect drainage may cause wetting of the building, furniture, etc.
- Do not place objects in direct proximity of the outdoor unit and do not let leaves and other debris accumulate around the unit. Leaves are a hotbed for small animals which can enter the unit. Once inside the unit, such animals can cause malfunctions, smoke or fire if they come into contact with electrical parts.
- Do not place objects around the indoor unit.  
Doing so may have an adverse influence on the performance, product quality, and life of the air conditioner.
- This appliance is not intended to be used by persons with reduced physical, sensory or mental capabilities, or with lack of operation knowledge, unless they have been given supervision or instruction concerning the appliance use by person responsible for their safety. Keep out of children's reach to ensure that they do not play with the appliance.

FFP008

### Installation site

- To install the air conditioner in the following types of environments, consult your dealer.
  - Places with an oily environment or where steam or soot occurs.
  - Salty environments such as coastal areas.
  - Places where sulphide gas occurs such as hot springs.
  - Places where snow may block the outdoor unit.
- Be sure to follow the instructions below.
  - The indoor unit is at least 1m away from any television or radio set (unit may cause interference with the picture or sound).
  - The drain from the outdoor unit must be discharged to a place of good drainage.

### Consider nuisance to your neighbours from noises

- For installation, choose a place as described below.
  - A place solid enough to bear the weight of the unit and which does not amplify the operation noise or vibration.
  - A place from where the air discharged from the outdoor unit or the operation noise will not annoy your neighbours.

### Electrical work

- For the power supply, be sure to use a separate power circuit dedicated to the air conditioner.

### System relocation

- Relocating the air conditioner requires specialized knowledge and skills. Please consult your dealer if relocation is necessary for moving or remodelling.

# Names of Parts

## Indoor Unit

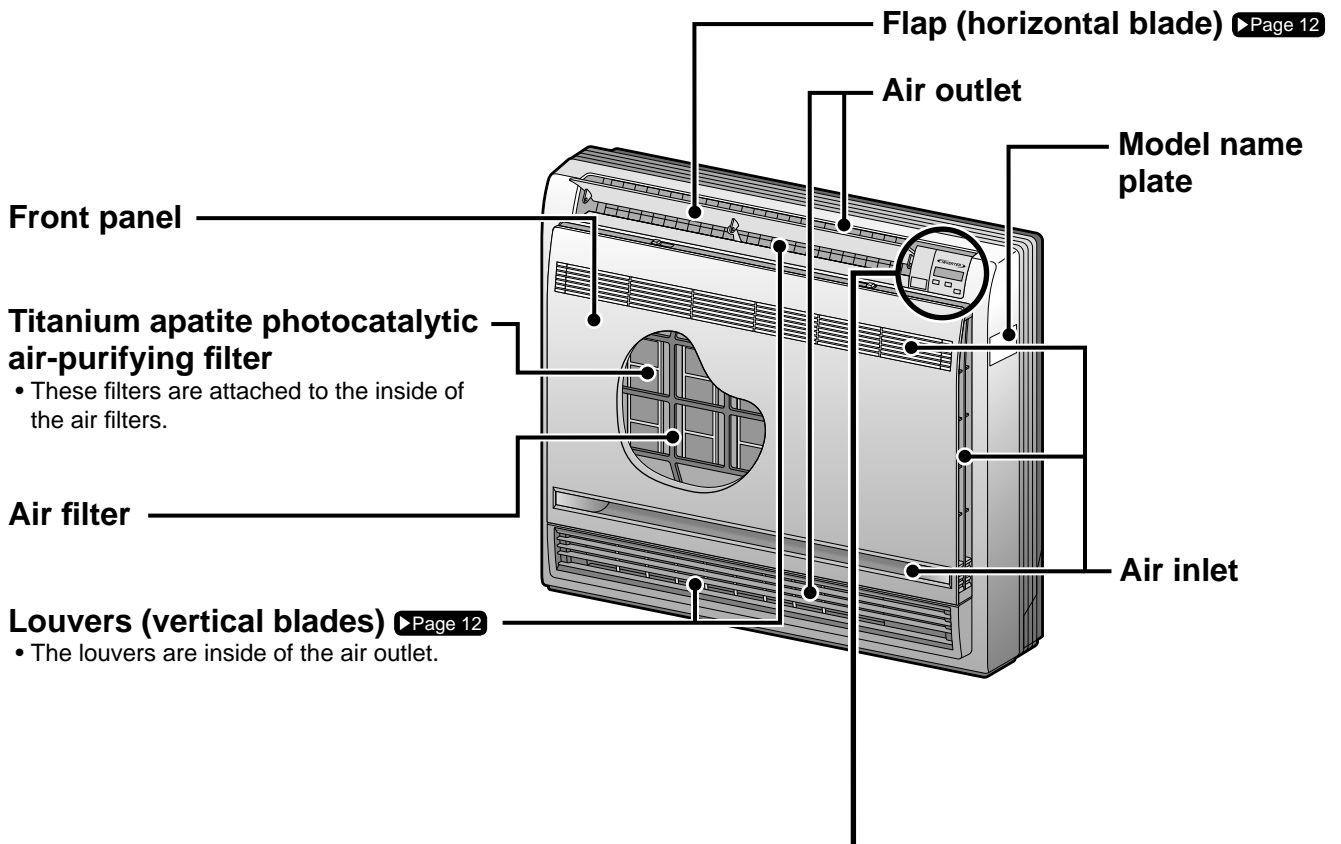

### Control panel

**OPERATION lamp (green)**

**TIMER lamp (yellow)** ▶Page 17

**Indoor unit ON/OFF switch**

- Push this switch once to start operation. Push once again to stop it.
- The operation mode refers to the following table.

Mode	Temperature setting	Airflow rate
AUTO	25°C	AUTO

- This switch is useful when the remote controller is missing.

**Signal receiver**

- It receives signals from the remote controller.
- When the unit receives a signal, you will hear a short beep.
  - Operation start ..... beep-beep
  - Settings changed ..... beep
  - Operation stop ..... long beep

## Open the front panel

- How to open the front panel: ▶Page 26

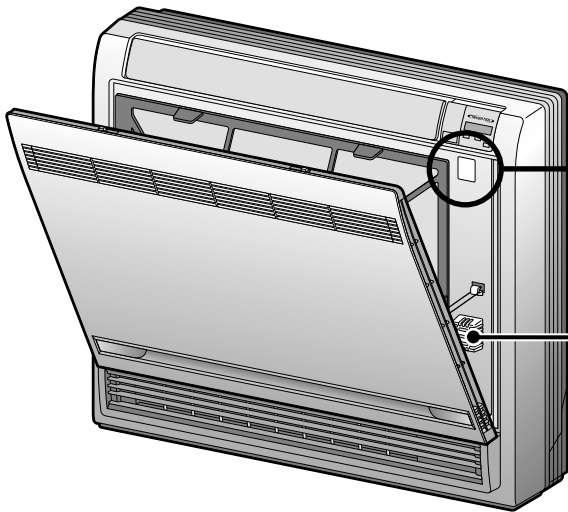

### Air outlet selection switch

▶Page 13

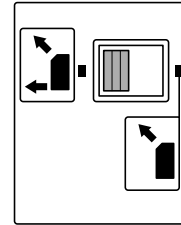

- This setting blows air from upper outlet only.



- This setting automatically decides a blow pattern depending on mode and conditions.
- This setting is recommended.
- The unit is shipped from the factory with this setting.

### Room temperature sensor

- It senses the air temperature around the unit.

## ⚠ CAUTION

- Before opening the front panel, be sure to stop the operation and turn the breaker off.
- Do not touch the metal parts on the inside of the indoor unit, as it may result in injury.

## Outdoor Unit

- Appearance of the outdoor unit may differ from some models.

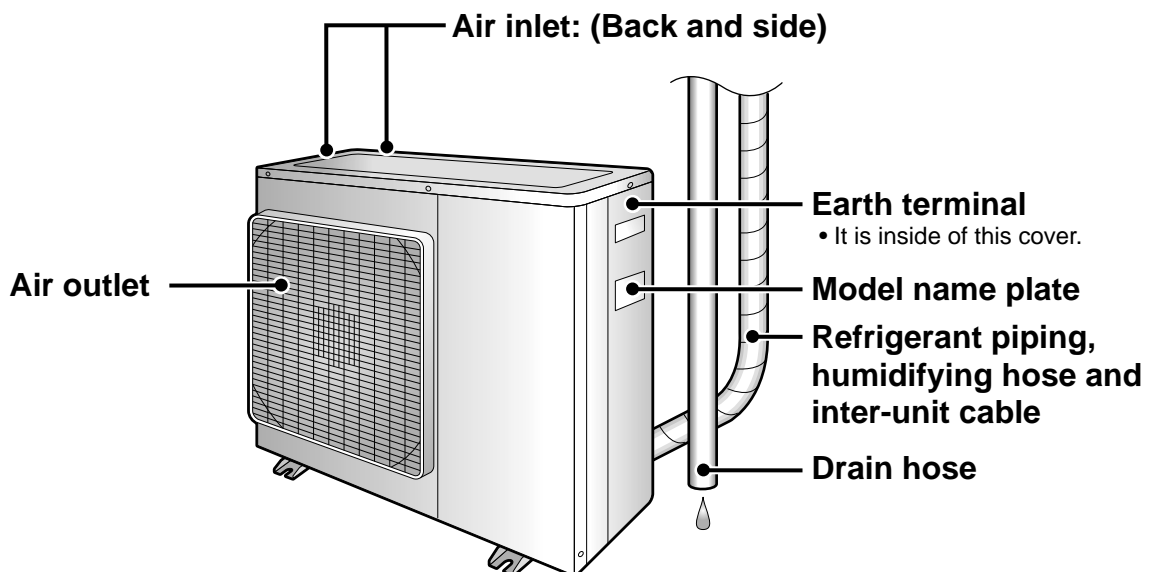

# Names of Parts

## Remote Controller: ARC452A2

### Signal transmitter

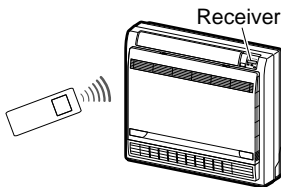

- To use the remote controller, aim the transmitter at the indoor unit. If there is anything blocking the signals between the unit and the remote controller, such as a curtain, the unit may not operate.
- Do not drop the remote controller. Do not get it wet.
- The maximum distance for communication is approximately 7m.

### FAN setting button

- It selects the airflow rate setting.

▶Page 11

### POWERFUL button

- POWERFUL operation ▶Page 14

### Display (LCD)

- It displays the current settings. (In this illustration, each section is shown with its displays on for the purpose of explanation.)

### TEMPERATURE adjustment buttons

- It changes the temperature setting.

▶Page 10

### ON/OFF button

- Press this button once to start operation.

Press once again to stop it. ▶Page 10

### Front cover

- Open the front cover. ▶Page 7

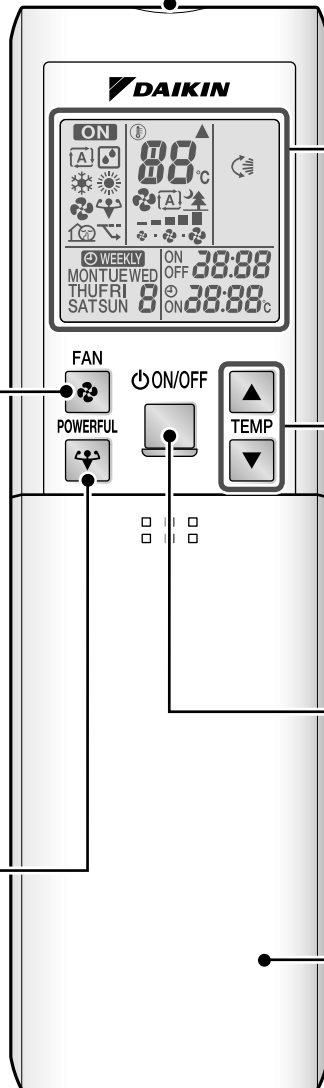



**Open the front cover**

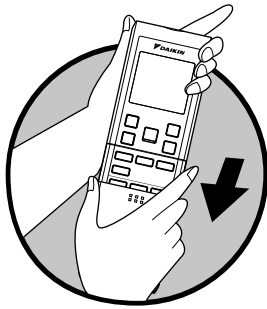

**MODE selector button**  
 • It selects the operation mode.  
 (AUTO/DRY/COOL/HEAT/FAN) ▶Page 10

**ECONO button**  
 • ECONO operation ▶Page 16

**SWING button**  
 • Adjusting the airflow direction  
 ▶Page 12

**QUIET button**  
 • OUTDOOR UNIT QUIET operation  
 ▶Page 15

WEEKLY : WEEKLY button  
 ◀▶ : PROGRAM button  
 COPY : COPY button  
 BACK : BACK button  
 NEXT : NEXT button  
 • WEEKLY TIMER operation  
 ▶Page 19

**ON TIMER button**  
 ▶Page 18

**CLOCK button** ▶Page 9

**OFF TIMER button**  
 ▶Page 17

**TIMER CANCEL button**  
 • It cancels the timer setting.  
 ▶Page 17,18  
 • It cannot be used for the WEEKLY TIMER operation.

**SELECT button**  
 • It changes the ON/OFF TIMER and WEEKLY TIMER settings.  
 ▶Page 17,18,19

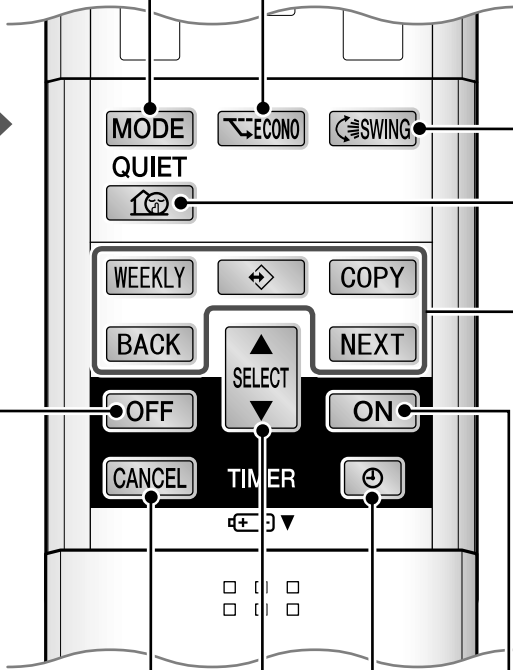

# Preparation before Operation

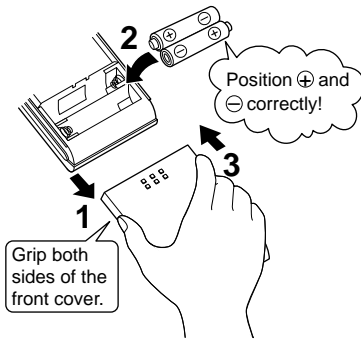

## ■ To set the batteries

1. Slide the front cover to take it off.
2. Set 2 dry batteries AAA.LR03 (alkaline).
3. Set the front cover as before.

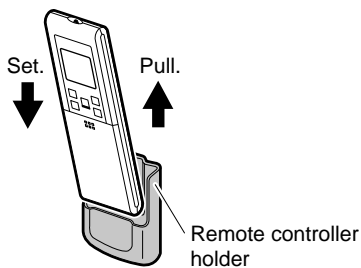

## ■ To fix the remote controller holder on the wall

1. Choose a place from where the signals reach the unit.
2. Fix the holder to a wall, a pillar, etc. with the screws supplied with the holder.
3. Place the remote controller in the remote controller holder.

## ■ Turn the breaker on

- After the power is turned on, the flap of the indoor unit opens and closes once to set the reference position.

## NOTE

### ■ Notes on batteries

- When replacing the batteries, use batteries of the same type, and replace the both old batteries together.
- When the system is not used for a long time, take the batteries out.
- The batteries will last for approximately 1 year. If the remote controller display begins to fade and the degradation of reception performance occurs within a year, however, replace both batteries with new, size AAA.LR03 (alkaline).
- The attached batteries are provided for the initial use of the system.  
The usable period of the batteries may be short depending on the manufactured date of the air conditioner.

### ■ Notes on remote controller

- Never expose the remote controller to direct sunlight.
- Dust on the signal transmitter or receiver will reduce the sensitivity. Wipe off dust with soft cloth.
- Signal communication may be disabled if an electronic-starter-type fluorescent lamp (such as inverter-type lamps) is in the room. Consult the shop if that is the case.
- If the remote controller signals happen to operate another appliance, move that appliance to somewhere else, or consult the service shop.

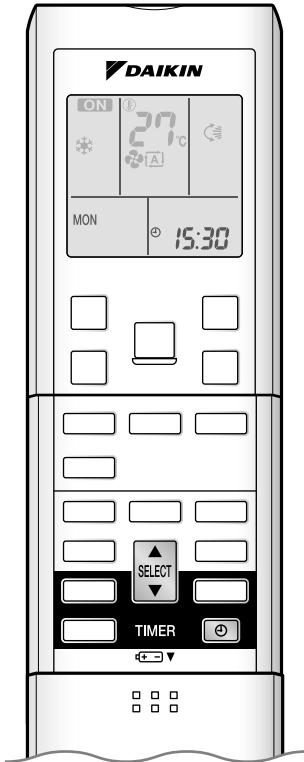

## ■ To set the clock

1. Press .

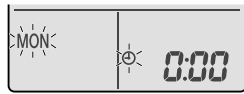

"0:00" is displayed.

"MON" and "🕒" blink.

2. Press  to set the current day of the week.

3. Press .



"🕒" blinks.

4. Press  to set the clock to the present time.

- Holding down  button rapidly increases or decreases the time display.

5. Press .

- Point the remote controller at the indoor unit when pushing the buttons when setting the indoor unit's internal clock.



"🕒" blinks.

## NOTE

- If the indoor unit's internal clock is not set to the correct time, ON/OFF TIMER and WEEKLY TIMER will not operate punctually.

### ■ Tips for saving energy

- Be careful not to cool (heat) the room too much.  
Keeping the temperature setting at a moderate level helps save energy.
- Cover windows with a blind or a curtain.  
Blocking sunlight and air from outdoors increases the cooling (heating) effect.
- A clogged air filter causes inefficient operation and wastes energy. Clean it once every 2 weeks.

#### Recommended temperature setting

For cooling: 26-28°C

For heating: 20-24°C

### ■ Please note

- The air conditioner always consumes a small amount of electricity even while it is not operating.
- If you are not going to use the air conditioner for a long period, for example in spring or autumn, turn the breaker off.
- Use the air conditioner in the following conditions.

Mode	Operating conditions	If operation is continued out of this range
COOL	Outdoor temperature : 10-46°C Indoor temperature : 18-32°C Indoor humidity : 80% max.	<ul style="list-style-type: none"> <li>• A safety device may work to stop the operation.</li> <li>• Condensation may occur on the indoor unit and drip.</li> </ul>
HEAT	Outdoor temperature : -15-24°C Indoor temperature : 10-30°C	<ul style="list-style-type: none"> <li>• A safety device may work to stop the operation.</li> </ul>
DRY	Outdoor temperature : 10-46°C Indoor temperature : 18-32°C Indoor humidity : 80% max.	<ul style="list-style-type: none"> <li>• A safety device may work to stop the operation.</li> <li>• Condensation may occur on the indoor unit and drip.</li> </ul>

- Operation outside this humidity or temperature range may cause a safety device to disable the system.

# AUTO · DRY · COOL · HEAT · FAN Operation

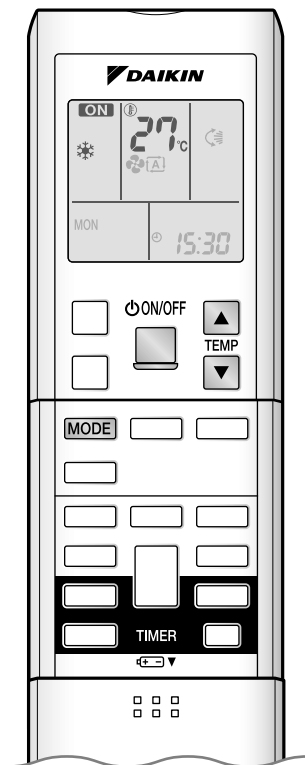

The air conditioner operates with the operation mode of your choice. From the next time on, the air conditioner will operate with the same operation mode.

## ■ To start operation

### 1. Press **MODE** and select an operation mode.

- Each pressing of the button advances the mode setting in sequence.

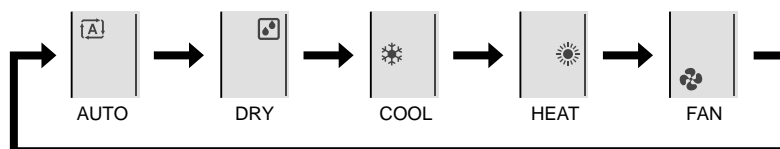

### 2. Press **ON/OFF**.

- “ON” is displayed on the LCD.
- The OPERATION lamp lights green.

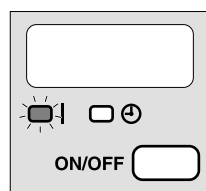

Control panel

## ■ To stop operation

Press **ON/OFF** again.

- “ON” disappears from the LCD.
- The OPERATION lamp goes off.

## ■ To change the temperature setting

Press **TEMP** (up arrow) or **TEMP** (down arrow).

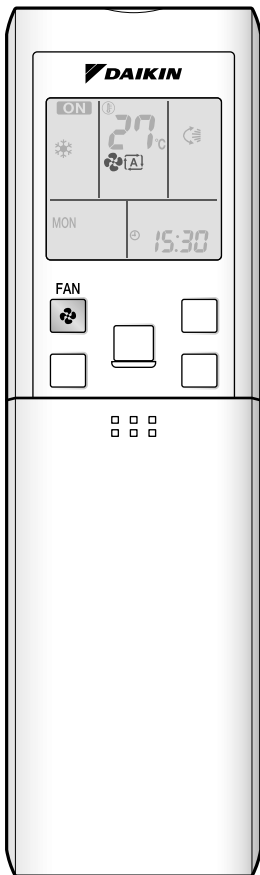

- The displayed items on the LCD will change whenever either one of the buttons is pressed.

	DRY or FAN operation	COOL operation	HEAT operation	AUTO operation
The temperature setting is not variable.		18-32°C	10-30°C	18-30°C
		Press ▲ to raise the temperature and press ▼ to lower the temperature.		



## ■ To change the airflow rate setting

Press .

DRY operation	AUTO or COOL or HEAT or FAN operation
The airflow rate setting is not variable.	Five levels of airflow rate setting from “  ” to “  ” plus “  ” and “  ” are available. 

- Indoor unit quiet operation.  
When the airflow is set to “”, the noise from the indoor unit will become quieter. Use this when making the noise quieter. The unit might lose capacity when the airflow rate is set to a weak level.
- Each pressing of the button advances the airflow rate setting in sequence.



## NOTE

### ■ Notes on HEAT operation

- Since this air conditioner heats the room by taking heat from outdoor air to indoors, the heating capacity becomes smaller in lower outdoor temperatures. If the heating effect is insufficient, it is recommended to use another heating appliance in combination with the air conditioner.
- The heat pump system heats the room by circulating hot air around all parts of the room. After the start of heating operation, it takes some time before the room gets warmer.
- In heating operation, frost may occur on the outdoor unit and lower the heating capacity. In that case, the system switches into defrosting operation to take away the frost.
- During defrosting operation, hot air does not flow out of indoor unit.

### ■ Note on COOL operation

- This air conditioner cools the room by releasing the heat in the room outside. Therefore, the cooling performance of the air conditioner may be degraded if the outdoor temperature is high.

### ■ Note on DRY operation

- The computer chip works to rid the room of humidity while maintaining the temperature as much as possible. It automatically controls temperature and airflow rate, so manual adjustment of these functions is unavailable.

### ■ Notes on AUTO operation

- In AUTO operation, the system selects an appropriate operation mode (COOL or HEAT) based on the room and outside temperatures and starts the operation.
- The system automatically reselects setting at a regular interval to bring the room temperature to user-setting level.
- If you do not like AUTO operation, manually change the set temperature.

### ■ Note on FAN operation

- This mode is valid for fan only.

### ■ Note on airflow rate setting

- At smaller airflow rates, the cooling (heating) effect is also smaller.

# Adjusting the Airflow Direction

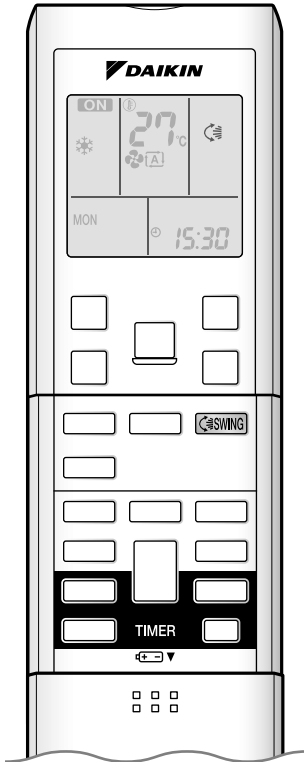

You can adjust the airflow direction to increase your comfort.

## Adjusting the upper and lower airflow direction

### ■ To adjust the flap (horizontal blade)

#### 1. Press .

- “” is displayed on the LCD and the flap will begin to swing.

#### 2. When the flap has reached the desired position, press once more.

- The flap will stop moving.
- “” disappears from the LCD.

## Adjusting the right and left airflow direction

### ■ To adjust the louvers (vertical blades)

Hold the knob and move the louvers.

(You will find a knob on the left-side and the right-side blades.)

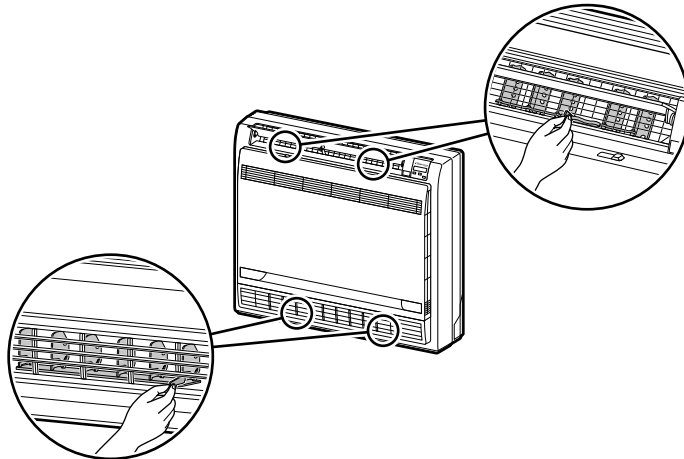

## CAUTION

- Do not try to adjust the flap by hand.  
If the flap is adjusted by hand, the mechanism may not operate properly or condensation may drip from the air outlet. If the flap is adjusted without using the remote controller, turn off the unit once, and use the remote controller to restart the unit.
- Be careful when adjusting the louvers. Inside the air outlet, a fan is rotating at a high speed.
- While the outdoor unit is not in operation because the indoor temperature becomes higher (or lower) than the set temperature, the flap will come to a stop.

## NOTE

### ■ Note on flap and louvers angle

- Unless “SWING” is selected, you should set the flap at a near-horizontal angle in FAN or HEAT operation and at a upward position in COOL or DRY operation to obtain the best performance.

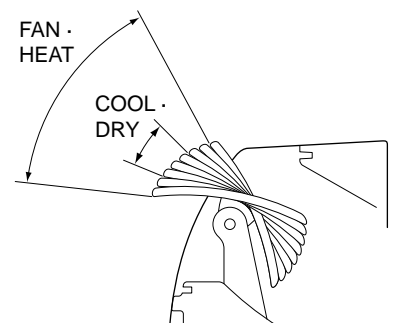











## ■ Air outlet selection

- Make air outlet selection according to what suits you. ▶Page 5

### When setting the air outlet selection switch to .

- Air conditioner automatically decides the appropriate blowing pattern depending on the operating mode/situation.

Mode	Situation	Blowing pattern	
COOL 	When the operation is activated or when the room is not fully cooled.		Air is emitted from the upper and lower air outlets in order to reach the set temperature quickly.
	When the room has become fully cool, or when 1 hour has passed since turning on the air conditioner.		Air is emitted only from the upper air outlet so that air does not come into direct contact with people and indoor temperature is equalized.
HEAT 	When the operation is activated or when air emitted is of low temperature.		Air is emitted only from the upper air outlet so that air does not come into direct contact with people.
	At times other than the above situations.		Air is emitted from the upper and lower air outlets so that warm air is spread throughout the whole room.
DRY 	Whenever in DRY mode.		Air is emitted only from the upper air outlet so that air does not come into direct contact with people.
FAN 	Whenever in FAN mode.		
AUTO 	Operates in the actual operation mode of the air conditioner according to the descriptions in this table. (COOL or HEAT)		

### When setting the air outlet selection switch to .

- Regardless of the operating mode or situation, air is emitted from the upper air outlet.
- Use this switch when you do not want air coming out of the lower air outlet. (While sleeping, etc.)

# POWERFUL Operation

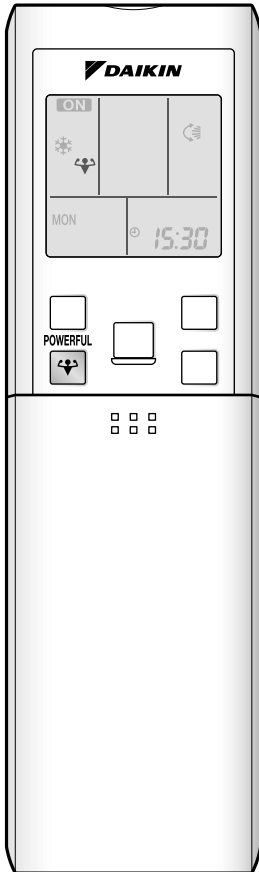

POWERFUL operation quickly maximizes the cooling (heating) effect in any operation mode. You can get the maximum capacity.

## ■ To start POWERFUL operation

Press  during operation.

- POWERFUL operation ends in 20 minutes. Then the system automatically operates again with the previous settings which were used before POWERFUL operation.
- “” is displayed on the LCD.
- When using POWERFUL operation, there are some functions which are not available.

## ■ To cancel POWERFUL operation

Press  again.

- “” disappears from the LCD.

## NOTE

### ■ Notes on POWERFUL operation

- POWERFUL operation cannot be used together with ECONO or QUIET operation. Priority is given to the function of whichever button is pressed last.
- POWERFUL operation can only be set when the unit is running. Pressing the operation stop button causes the settings to be canceled, and the “” disappears from the LCD.
- POWERFUL operation will not increase the capacity of the air conditioner if the air conditioner is already in operation with its maximum capacity demonstrated.
- **In COOL, HEAT and AUTO operation**  
To maximize the cooling (heating) effect, the capacity of outdoor unit is increased and the airflow rate is fixed to the maximum setting. The temperature and airflow settings are not variable.
- **In DRY operation**  
The temperature setting is lowered by 2.5°C and the airflow rate is slightly increased.
- **In FAN operation**  
The airflow rate is fixed to the maximum setting.



# OUTDOOR UNIT QUIET Operation

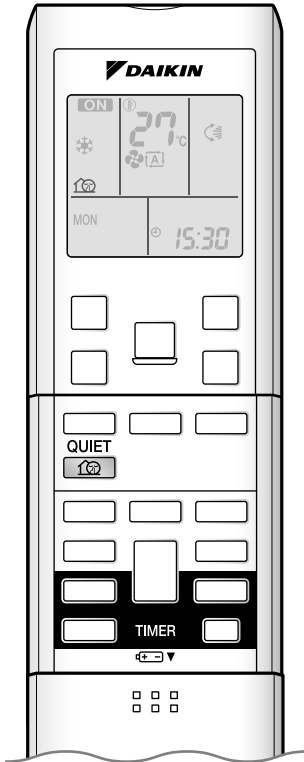

OUTDOOR UNIT QUIET operation lowers the noise level of the outdoor unit by changing the frequency and fan speed on the outdoor unit. This function is convenient during night.

## ■ To start OUTDOOR UNIT QUIET operation

Press .

- “” is displayed on the LCD.

## ■ To cancel OUTDOOR UNIT QUIET operation

Press  again.

- “” disappears from the LCD.

## NOTE

### ■ Notes on OUTDOOR UNIT QUIET operation

- This function is available in COOL, HEAT and AUTO operation.  
(This is not available in FAN and DRY operations.)
- POWERFUL operation and OUTDOOR UNIT QUIET operation cannot be used at the same time.  
Priority is given to the function of whichever button is pressed last.
- If operation is stopped using the remote controller or the indoor unit ON/OFF switch when using OUTDOOR UNIT QUIET operation, “” will remain on the remote controller display.
- OUTDOOR UNIT QUIET operation will drop neither the frequency nor fan speed if the frequency and fan speed have been already dropped low enough.

# ECONO Operation

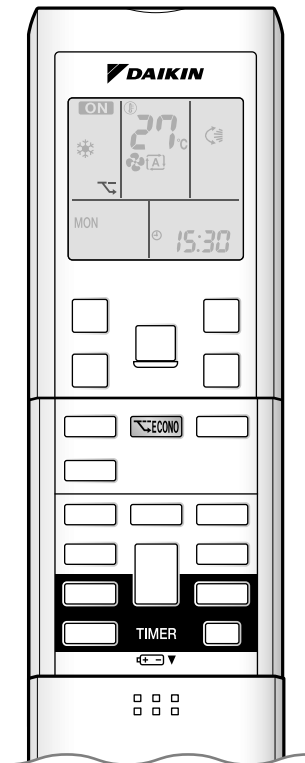

ECONO operation is a function which enables efficient operation by limiting the maximum power consumption value. This function is useful for cases in which attention should be paid to ensure a circuit breaker will not trip when the product runs alongside other appliances.

## ■ To start ECONO operation

Press  during operation.

- “” is displayed on the LCD.

## ■ To cancel ECONO operation

Press  again.

- “” disappears from the LCD.

Running current and power consumption

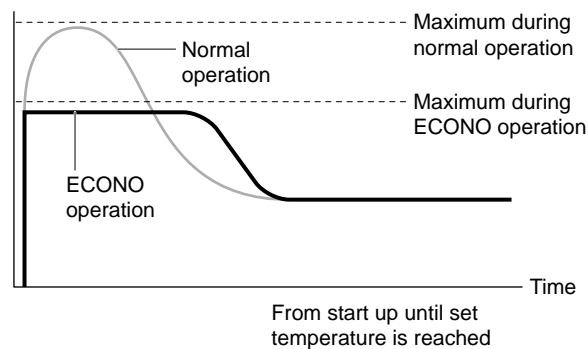

- This diagram is a representation for illustrative purposes only.

\* The maximum running current and power consumption of the air conditioner in ECONO operation vary with the connecting outdoor unit.

## NOTE

### ■ Notes on ECONO operation

- ECONO Operation can only be set when the unit is running. Pressing the operation stop button causes the settings to be canceled, and the “” disappears from the LCD.
- ECONO operation is a function which enables efficient operation by limiting the power consumption of the outdoor unit (operating frequency).
- ECONO operation functions in AUTO, COOL, DRY and HEAT operations.
- POWERFUL and ECONO operation cannot be used at the same time. Priority is given to the function of whichever button is pressed last.
- Power consumption may not drop even if ECONO operation is used if the level of power consumption is already low.

# TIMER Operation

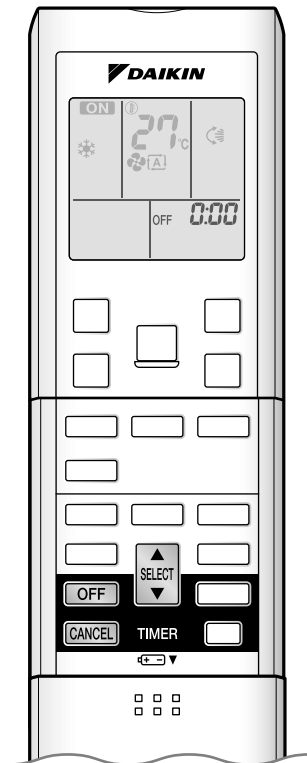

Timer functions are useful for automatically switching the air conditioner on or off at night or in the morning. You can also use OFF TIMER and ON TIMER in combination.

## ■ To use OFF TIMER operation

- Check that the clock is correct.  
If not, set the clock to the present time. ▶Page 9

### 1. Press **OFF**.



“0:00” is displayed.  
“OFF” blinks.

- “⌚” and day of the week disappear from the LCD.

### 2. Press **SELECT** until the time setting reaches the point you like.

- Each pressing of either button increases or decreases the time setting by 10 minutes.  
Holding down either button changes the setting rapidly.

### 3. Press **OFF** again.

- “OFF” and setting time are displayed on the LCD.
- The TIMER lamp lights yellow.

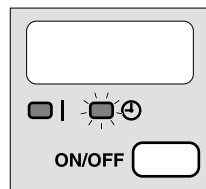

Control panel

## ■ To cancel OFF TIMER operation

### Press **CANCEL**.

- “OFF” and setting time disappear from the LCD.
- “⌚” and day of the week are displayed on the LCD.
- The TIMER lamp goes off.

## NOTE

### ■ Notes on TIMER operation

- When TIMER is set, the present time is not displayed.
- Once you set ON/OFF TIMER, the time setting is kept in the memory. (The memory is canceled when remote controller batteries are replaced.)
- When using the ON/OFF TIMER to start/stop operation, the actual operation start/stop time may differ from the time set. (Maximum of about 10 minutes)

### ■ NIGHT SET MODE

- When the OFF TIMER is set, the air conditioner automatically adjusts the temperature setting (0.5°C up in COOL, 2.0°C down in HEAT) to prevent excessive cooling (heating) for your pleasant sleep.

# TIMER Operation

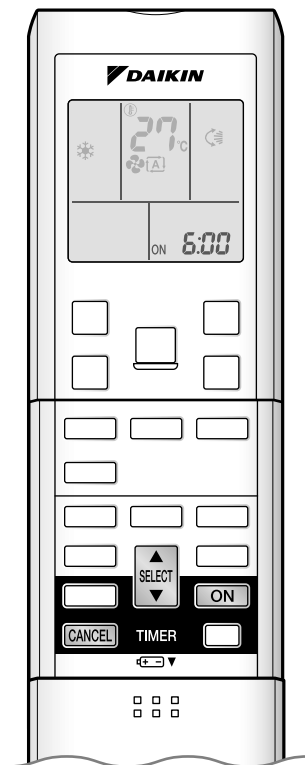

## ■ To use ON TIMER operation

- Check that the clock is correct.  
If not, set the clock to the present time. ▶Page 9

### 1. Press **ON**.



"6:00" is displayed.

"ON" blinks.

- "⌚" and day of the week disappear from the LCD.

### 2. Press **SELECT** until the time setting reaches the point you like.

- Each pressing of either button increases or decreases the time setting by 10 minutes.  
Holding down either button changes the setting rapidly.

### 3. Press **ON** again.

- "ON" and setting time are displayed on the LCD.
- The TIMER lamp lights yellow.

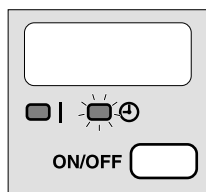

Control panel

## ■ To cancel ON TIMER operation

Press **CANCEL**.

- "ON" and setting time disappear from the LCD.
- "⌚" and day of the week are displayed on the LCD.
- The TIMER lamp goes off.

## ■ To combine ON TIMER and OFF TIMER

- A sample setting for combining the 2 timers is shown below.

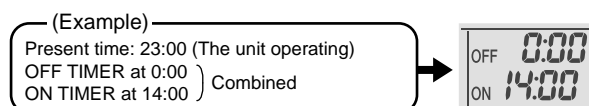

## ATTENTION

### ■ In the following cases, set the timer again.

- After a breaker has turned off.
- After a power failure.
- After replacing batteries in the remote controller.

# WEEKLY TIMER Operation

Up to 4 timer settings can be saved for each day of the week. It is convenient if the WEEKLY TIMER is set according to the family's life style.

## ■ Using in these cases of WEEKLY TIMER

An example of WEEKLY TIMER settings is shown below.

**Example:** The same timer settings are made for the week from Monday through Friday while different timer settings are made for the weekend.

<p><b>[Monday]</b></p>	<p>Make timer settings up to programs 1-4. <a href="#">▶Page 20</a></p>
<p><b>[Tuesday] to [Friday]</b></p>	<p>Use the copy mode to make settings for Tuesday to Friday, because these settings are the same as those for Monday. <a href="#">▶Page 22</a></p>
<p><b>[Saturday]</b></p>	<p>No timer settings</p>
<p><b>[Sunday]</b></p>	<p>Make timer settings up to programs 1-4. <a href="#">▶Page 20</a></p>

- Up to 4 reservations per day and 28 reservations per week can be set in the WEEKLY TIMER. The effective use of the copy mode ensures ease of making reservations.
- The use of ON-ON-ON-ON settings, for example, makes it possible to schedule operating mode and set temperature changes. Furthermore, by using OFF-OFF-OFF-OFF settings, only the turn-off time of each day can be set. This will turn off the air conditioner automatically if the user forgets to turn it off.

# WEEKLY TIMER Operation

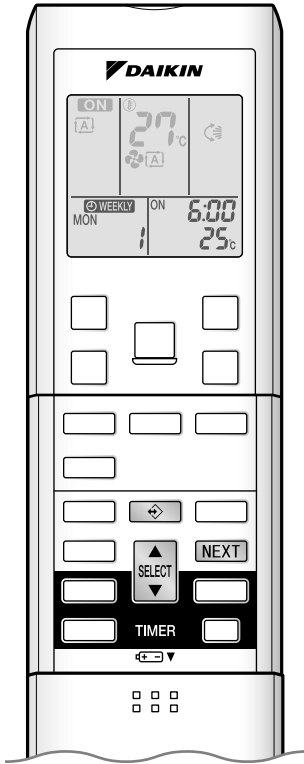

## ■ To use WEEKLY TIMER operation

### Setting mode

- Make sure the day of the week and time are set. If not, set the day of the week and time.

▶ Page 9

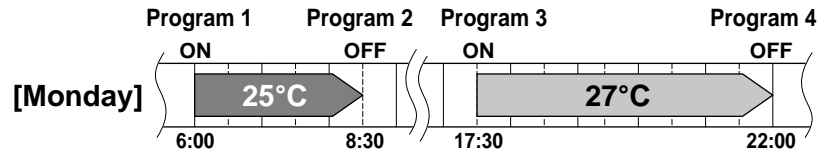

### Setting Displays

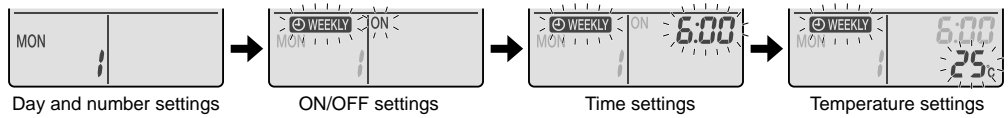

## 1. Press .

- The day of the week and the reservation number of the current day will be displayed.
- 1 to 4 settings can be made per day.

## 2. Press to select the desired day of the week and reservation number.

- Pressing  changes the reservation number and the day of the week.

## 3. Press .

- The day of the week and reservation number will be set.
- “WEEKLY” and “ON” blink.

## 4. Press to select the desired mode.

- Pressing  changes “ON” or “OFF” setting in sequence.



- In case the reservation has already been set, selecting “blank” deletes the reservation.
- Go to STEP 9 if “blank” is selected.

## 5. Press .

- The ON/OFF TIMER operation will be set.
- “WEEKLY” and the time blink.

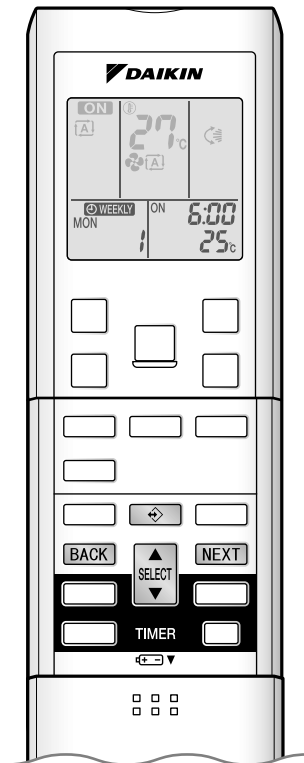

## 6. Press to select the desired time.

- The time can be set between 0:00 and 23:50 in 10 minute intervals.
- To return to the mode setting, press .
- Go to STEP 9 when setting the OFF TIMER.

## 7. Press .

- The time will be set.
- “ WEEKLY” and the temperature blink.

## 8. Press to select the desired temperature.

- The temperature can be set between 10°C and 32°C.  
Cooling: The unit operates at 18°C even if it is set at 10 to 17°C.  
Heating: The unit operates at 30°C even if it is set at 31 to 32°C.
- To return to the time setting, press .
- The set temperature is only displayed when the mode setting is on.

## 9. Press .

- Be sure to direct the remote controller toward the indoor unit and check for a receiving tone and flashing the OPERATION lamp.
- The temperature will be set and go to the next reservation setting.
- To continue further settings, repeat the procedure from STEP 4.
- The TIMER lamp lights yellow.

## 10. Press to complete the setting.

- “ WEEKLY” is displayed on the LCD and WEEKLY TIMER operation is activated.

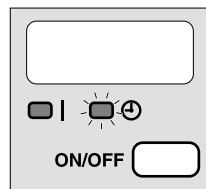





Control panel

- A reservation made once can be easily copied and the same settings used for another day of the week. Refer to **Copy mode** . 

## NOTE

### ■ Notes on WEEKLY TIMER operation

- Do not forget to set the clock on the remote controller first. 
- The day of the week, ON/OFF TIMER operation, time and set temperature (only for ON TIMER operation) can be set with WEEKLY TIMER. Other settings for ON TIMER are based on the settings just before the operation.
- Both WEEKLY TIMER and ON/OFF TIMER operation cannot be used at the same time. The ON/OFF TIMER operation has priority if it is set while WEEKLY TIMER is still active. The WEEKLY TIMER will go into standby state, and “ WEEKLY” will disappear from the LCD. When ON/OFF TIMER is up, the WEEKLY TIMER will automatically become active.
- Only the time and set temperature set with the weekly timer are sent with the .
- Set the weekly timer only after setting the operation mode, the fan strength, and the fan direction ahead of time.
- Shutting the breaker off, power failure, and other similar events will render operation of the indoor unit's internal clock inaccurate. Reset the clock. 
- The  can be used only for the mode, time and temperature settings. It cannot be used to go back to the reservation number.

# WEEKLY TIMER Operation

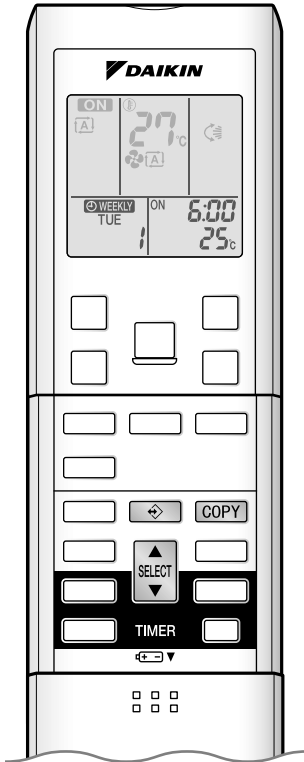

## Copy mode

- A reservation made once can be copied another day of the week. The whole reservation of the selected day of the week will be copied.

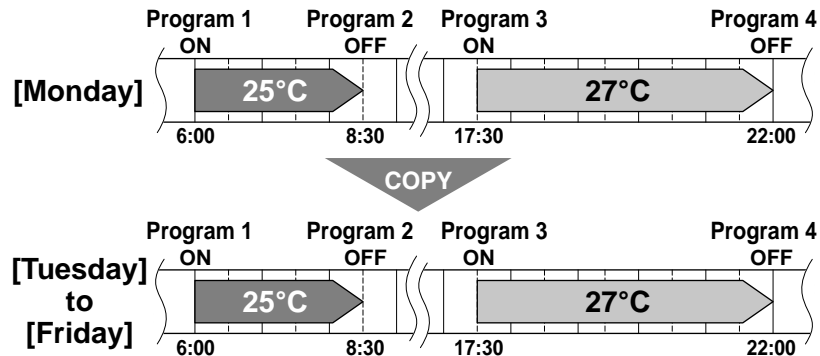

## Setting Displays

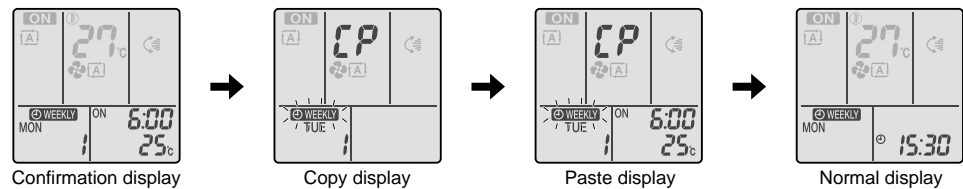

1. Press .
2. Press to confirm the day of the week to be copied.
3. Press to activate copy mode.
  - The whole reservation of the selected day of the week will be copied.
4. Press to select the destination day of the week.
5. Press .
  - The reservation will be copied to the selected day of the week. The whole reservation of the selected day of the week will be copied.
  - To continue copying the settings to other days of the week, repeat STEP 4 and STEP 5.
6. Press to complete the setting.
  - “ WEEKLY” is displayed on the LCD and WEEKLY TIMER operation is activated.

## NOTE

### ■ Note on copy mode

- The entire reservation of the source day of the week is copied in the copy mode.

In the case of making a reservation change for any day of the week individually after copying the content of weekly reservations, press and change the settings in the steps of **Setting mode** . ▶Page 20



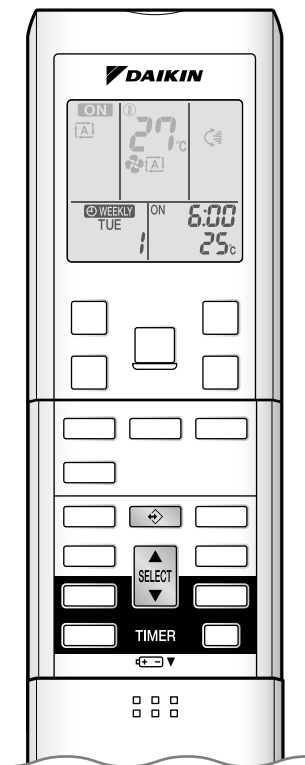

## ■ Confirming a reservation

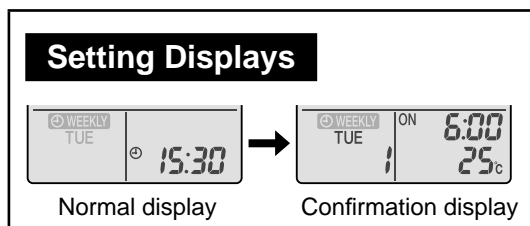

- The reservation can be confirmed.



### 1. Press .

- The day of the week and the reservation number of the current day will be displayed.

### 2. Press to select the day of the week and the reservation number to be confirmed.

- Pressing  displays the reservation details.
- To change the confirmed reserved settings, select the reservation number and press . The mode is switched to setting mode. Go to **Setting mode** STEP 4. 

### 3. Press to exit confirming mode.

- “ WEEKLY” is displayed on the LCD and WEEKLY TIMER operation is activated.
- The TIMER lamp lights yellow.

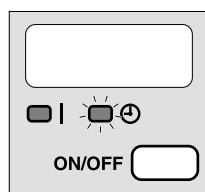

Control panel

# WEEKLY TIMER Operation

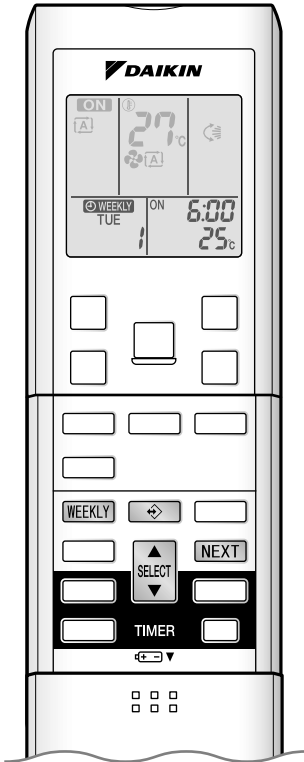

## ■ To deactivate WEEKLY TIMER operation

Press **WEEKLY** while “**WEEKLY**” is displayed on the LCD.



- “**WEEKLY**” will disappear from the LCD.
- The TIMER lamp goes off.
- To reactivate the WEEKLY TIMER operation, press **WEEKLY** again.
- If a reservation deactivated with **WEEKLY** is activated once again, the last reservation mode will be used.

## ■ To delete reservations



### The individual reservation

**1. Press** .

- The day of the week and the reservation number will be displayed.



**2. Press**  **SELECT**  to select the day of the week and the reservation number to be deleted.

**3. Press** **NEXT**.

- “**WEEKLY**” and “ON” or “OFF” blink.
- Pressing  **SELECT**  changes ON/OFF TIMER operation.
- The reservation will be no setting with selecting “blank”.

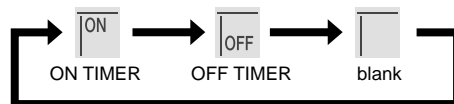
**4. Press**  **SELECT**  and select “blank”.



Pressing  **SELECT**  puts the sequence in reverse.

**5. Press** **NEXT**.

- The selected reservation is deleted.

**6. Press** .

- If there are still other reservations, WEEKLY TIMER operation will be activated.

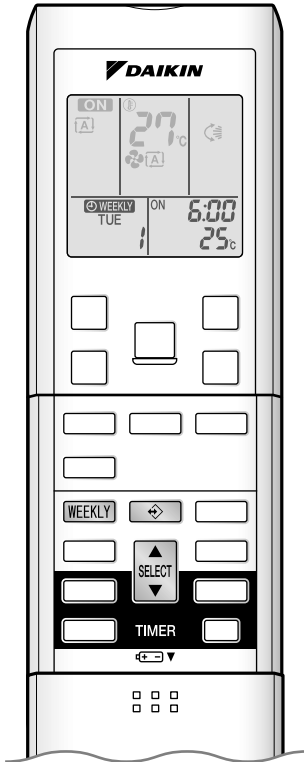

### The reservations for each day of the week

- This function can be used for deleting reservations for each day of the week.
- It can be used while confirming or setting reservations.

**1. Press**  .

- The day of the week and the reservation number will be displayed.

**2. Press**  to select the day of the week to be deleted.

**3. Hold**  for about 5 seconds.

- The reservation of the selected day of the week will be deleted.

**4. Press**  .

- If there are still other reservations, WEEKLY TIMER operation will be activated.

### All reservations

**Hold**  for 5 seconds.

- Be sure to direct the remote controller toward the indoor unit and check for a receiving tone.
- This operation is not effective while WEEKLY TIMER is being set.
- All reservations will be deleted.

# Care and Cleaning



## CAUTION

Before cleaning, be sure to stop the operation and turn the breaker off.

### Units

#### Indoor unit and remote controller

Wipe them with dry soft cloth.

### Front panel

#### 1. Open the front panel.

- Slide the 2 stoppers on the left and right sides inward until they click.

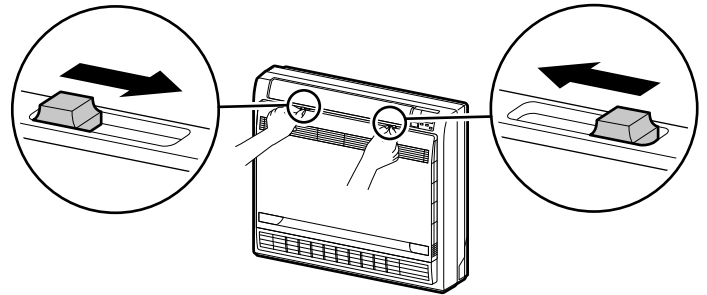

#### 2. Remove the front panel.

- Remove the 2 strings.
- Allowing the front panel to fall forward will enable you to remove it.

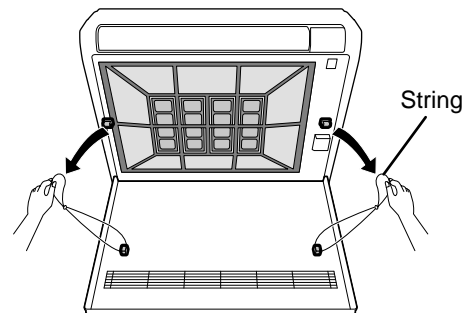

Place front panel in grooves.

#### 3. Clean the front panel.

- Wipe it with a soft cloth soaked in water.
- Only neutral detergent may be used.
- In case of washing the front panel with water, wipe it with dry soft cloth, dry it up in the shade after washing.

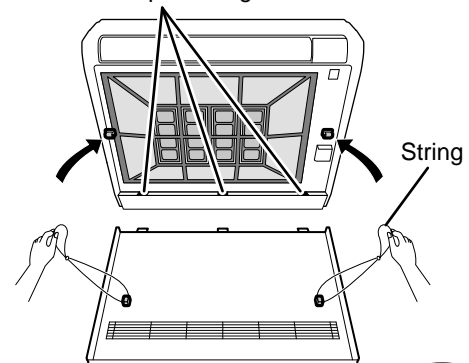

#### 4. Attach the front panel.

- Insert the front panel into the grooves of the unit (3 places).
- Attach the string to the right, inner-side of the front grille.
- Close the panel slowly.
- Slide the 2 stoppers on the left and right sides outward until they click.

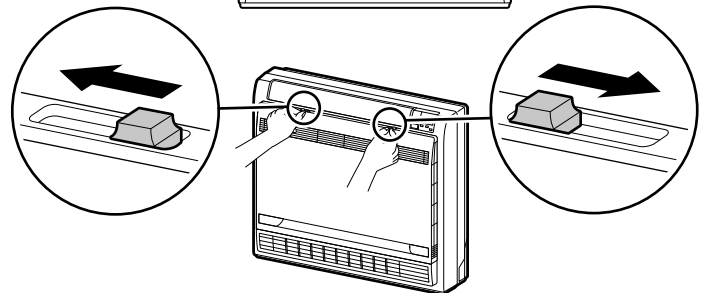

## CAUTION

- Do not touch the metal parts of the indoor unit. If you touch those parts, this may cause an injury.
- When removing or attaching the front panel, use a robust and stable stool and watch your steps carefully.
- When removing or attaching the front panel, support the panel securely with hand to prevent it from falling.
- For cleaning, do not use hot water above 40°C, benzene, gasoline, thinner, nor other volatile oils, polishing compound, scrubbing brushes, nor other hand stuff.
- After cleaning, make sure that the front panel is securely fixed.

## Filters

**1. Open the front panel.** ▶Page 26

**2. Remove the air filter.**

- Press the claws on the right and left of the air filter down slightly, then pull upward.

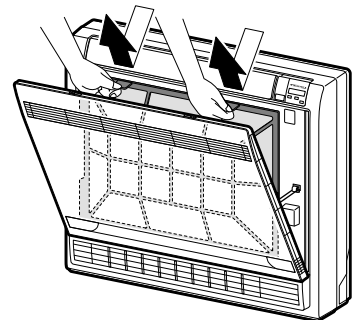

**3. Take off the titanium apatite photocatalytic air-purifying filter.**

- Hold the tabs of the frame, and remove the claws in 4 places.

**4. Clean or replace each filter.**

See figure.

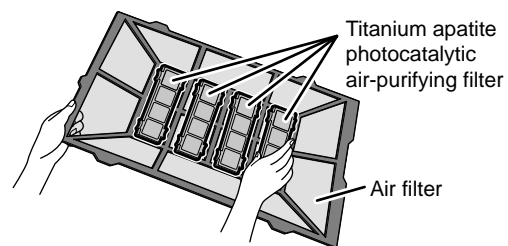

**5. Set the air filter and titanium apatite photocatalytic air-purifying filter as they were and close the front panel.**

- Operation without air filter may result in troubles as dust will accumulate inside the indoor unit.
- Insert the 2 tabs on the lower side of air filter into the body.
- Then, insert the 2 tabs on the upper side into the body.
- Insert the tab on the right side into the body.
- Close the panel slowly.
- Slide the 2 stoppers on the left and right sides outward until they click.

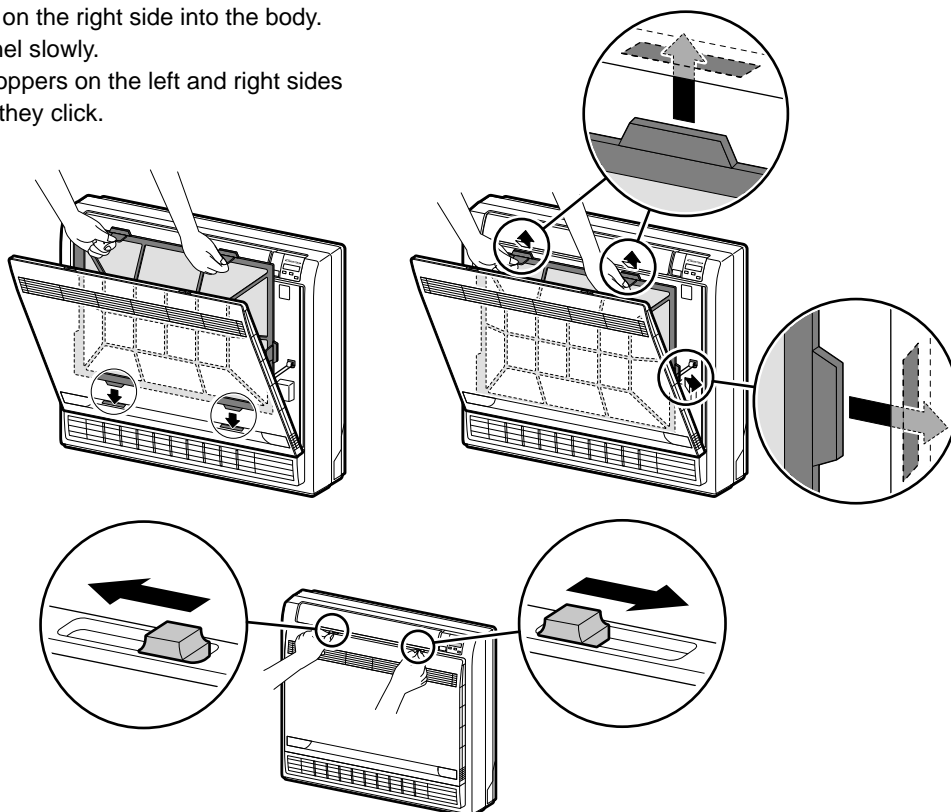

## ⚠ CAUTION

- Do not touch the aluminum fins by bare hand at the time of dismantling or mounting the filter.

# Care and Cleaning

## Air Filter

**Wash the air filter with water or clean them with vacuum cleaner.**

- If the dust does not come off easily, wash them with neutral detergent thinned with lukewarm water, then dry them up in the shade.
- It is recommended to clean the air filter every 2 weeks.

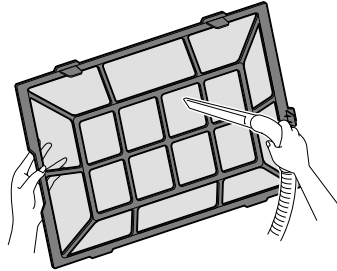

## CAUTION

- When cleaning the air filter, be careful not to damage or break the net of the filter.

## Titanium apatite photocatalytic air-purifying filter

The titanium apatite photocatalytic air-purifying filter can be renewed by washing it with water once every 6 months. We recommend replacing it once every 3 years. (Material : paper/polypropylene)

### [ Maintenance ]

**1. Vacuum dusts, and soak in warm water or water for about 10 to 15 minutes if dirt is heavy.**

- Do not remove filter from frame when washing with water.

**2. After washing, shake off remaining water and dry in the shade.**

- Since the material is made out of paper, do not wring out the filter when removing water from it.

### [ Replacement ]

**1. Remove the tabs on the filter frame and replace with a new filter.**

- Dispose of the old filter as flammable waste.

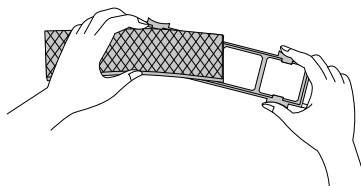

## NOTE

- Operation with dirty filters:
  - 1) cannot deodorize the air,
  - 2) cannot clean the air,
  - 3) results in poor heating or cooling,
  - 4) may cause odour.
- To order a titanium apatite photocatalytic air-purifying filter, contact the service shop where you bought the air conditioner.
- Dispose of old filters as flammable waste.

Item	Part No.
Titanium apatite photocatalytic air-purifying filter (without frame) 2 sets	KAF968B42

## ATTENTION



- Do not throw away the filter frame. Reuse the filter frame when replacing the titanium apatite photocatalytic air-purifying filter.

## CHECK

- Check that the base, stand and other fittings of the outdoor unit are not decayed or corroded.
- Check that nothing blocks the air inlets and the outlets of the indoor unit and the outdoor unit.
- Check that the drain comes smoothly out of the drain hose during COOL or DRY operation.
  - If no drain water is seen, water may be leaking from the indoor unit. Stop operation and consult the service shop if this is the case.

### Before a long idle period.

## 1. Operate the “FAN only” for several hours on a fine day to dry out the inside.

- Press **MODE** and select “” operation.
- Press  and start the operation.

## 2. After operation stops, turn off the breaker for the room air conditioner.

## 3. Clean the air filter and set it again.

## 4. Take out batteries from the remote controller.

# Troubleshooting

## These cases are not troubles.

The following cases are not air conditioner troubles but have some reasons. You may just continue using it.

Case	Explanation
<b>Operation does not start soon.</b> <ul style="list-style-type: none"> <li>When ON/OFF button was pressed soon after operation was stopped.</li> <li>When the mode was reselected.</li> </ul>	<ul style="list-style-type: none"> <li>This is to protect the air conditioner. You should wait for about 3 minutes.</li> </ul>
<b>Hot air does not flow out soon after the start of HEAT operation.</b>	<ul style="list-style-type: none"> <li>The air conditioner is warming up. You should wait for 1 to 4 minutes. (The system is designed to start discharging air only after it has reached a certain temperature.)</li> </ul>
<b>The HEAT operation stops suddenly and a flowing sound is heard.</b>	<ul style="list-style-type: none"> <li>The system is taking away the frost on the outdoor unit. You should wait for about 4 to 12 minutes.</li> </ul>
<b>A sound is heard.</b>	<ul style="list-style-type: none"> <li> <b>■ A sound like a flow of water</b> <ul style="list-style-type: none"> <li>This sound is generated because the refrigerant in the air conditioner is flowing.</li> <li>This is a pumping sound of the water in the air conditioner and heard when the water is pumped out from the air conditioner in cooling or drying operation.</li> <li>The refrigerant flows in the air conditioner even if the air conditioner is not working when the indoor units in other rooms are in operation.</li> </ul> </li> <li> <b>■ Blowing sound</b> <ul style="list-style-type: none"> <li>This sound is generated when the flow of the refrigerant in the air conditioner is switched over.</li> </ul> </li> <li> <b>■ Ticking sound</b> <ul style="list-style-type: none"> <li>This sound is generated when the size of the air conditioner slightly expands or shrinks as a result of temperature changes.</li> </ul> </li> <li> <b>■ Clicking sound during operation or idle time</b> <ul style="list-style-type: none"> <li>This sound is generated when the refrigerant control valves or the electrical parts operate.</li> </ul> </li> <li> <b>■ Clopping sound</b> <ul style="list-style-type: none"> <li>This sound is heard from the inside of the air conditioner when the exhaust fan is activated while the room doors are closed. Open the window or turn off the exhaust fan.</li> </ul> </li> </ul>
<b>The outdoor unit emits water or steam.</b>	<ul style="list-style-type: none"> <li> <b>■ In HEAT operation</b> <ul style="list-style-type: none"> <li>The frost on the outdoor unit melts into water or steam when the air conditioner is in defrost operation.</li> </ul> </li> <li> <b>■ In COOL or DRY operation</b> <ul style="list-style-type: none"> <li>Moisture in the air condenses into water on the cool surface of outdoor unit piping and drips.</li> </ul> </li> </ul>
<b>Mist comes out of the indoor unit.</b>	<ul style="list-style-type: none"> <li> <b>■ This happens when the air in the room is cooled into mist by the cold airflow during cooling operation.</b> </li> <li> <b>■ This is because the air in the room is cooled by the heat exchanger and becomes mist during defrost operation.</b> </li> </ul>
<b>The indoor unit gives out odour.</b>	<ul style="list-style-type: none"> <li> <b>■ This happens when smells of the room, furniture, or cigarettes are absorbed into the unit and discharged with the airflow.</b>                      (If this happens, we recommend you to have the indoor unit washed by a technician. Consult the service shop where you bought the air conditioner.)                 </li> </ul>



Case	Explanation
The outdoor fan rotates while the air conditioner is not in operation.	<ul style="list-style-type: none"> <li>■ After operation is stopped: <ul style="list-style-type: none"> <li>• The outdoor fan continues rotating for another 60 seconds for system protection.</li> </ul> </li> <li>■ While the air conditioner is not in operation: <ul style="list-style-type: none"> <li>• When the outdoor temperature is very high, the outdoor fan starts rotating for system protection.</li> </ul> </li> </ul>
The operation stopped suddenly. (OPERATION lamp is on.)	<ul style="list-style-type: none"> <li>• For system protection, the air conditioner may stop operating on a sudden large voltage fluctuation. It automatically resumes operation in about 3 minutes.</li> </ul>
No remote controller signals are displayed. The remote controller sensitivity is low. The display is low in contrast or blacked out. The display runs out of control.	<ul style="list-style-type: none"> <li>• The batteries are dying and the remote controller is malfunctioning. Replace all the batteries with new size batteries, AAA.LR03 (alkaline). For details, refer to set the batteries of this manual. ▶Page 8</li> </ul>
The ON/OFF TIMER does not operate according to the settings.	<ul style="list-style-type: none"> <li>• Check if the ON/OFF TIMER and the WEEKLY TIMER are set to the same time. Change or disable the settings in the WEEKLY TIMER. ▶Page 20</li> </ul>

## Check again.

Please check again before calling a repair person.

Case	Check
The air conditioner does not operate. (OPERATION lamp is off.)	<ul style="list-style-type: none"> <li>• Hasn't a breaker turned off or a fuse blown?</li> <li>• Isn't it a power failure?</li> <li>• Are batteries set in the remote controller?</li> <li>• Is the timer setting correct?</li> </ul>
Cooling (Heating) effect is poor.	<ul style="list-style-type: none"> <li>• Is the air filter clean?</li> <li>• Is there anything blocking the air inlet or the outlet of the indoor and the outdoor units?</li> <li>• Is the temperature setting appropriate?</li> <li>• Are the windows and doors closed?</li> <li>• Are the airflow rate and the air direction set appropriately?</li> </ul>
Operation stops suddenly. (OPERATION lamp flashes.)	<ul style="list-style-type: none"> <li>• Is the air filter clean? Clean the air filter.</li> <li>• Is there anything blocking the air inlet or the outlet of the indoor and the outdoor units? Turn the breaker off and take all obstacles away. Then turn it on again and try operating the air conditioner with the remote controller. If the lamp still flashes, call the service shop where you bought the air conditioner.</li> </ul>
An abnormal functioning happens during operation.	<ul style="list-style-type: none"> <li>• The air conditioner may malfunction with lightning or radio waves. Turn the breaker off, turn it on again and try operating the air conditioner with the remote controller.</li> </ul>
The flap does not start swinging immediately.	<ul style="list-style-type: none"> <li>• The air conditioner is adjusting the flap position. The flap will start moving soon.</li> </ul>

# Troubleshooting

## Call the service shop immediately.

### WARNING

■ **When an abnormality (such as a burning smell) occurs, stop operation and turn the breaker off.**

Continued operation in an abnormal condition may result in troubles, electric shocks or fire.  
Consult the service shop where you bought the air conditioner.

■ **Do not attempt to repair or modify the air conditioner by yourself.**

Incorrect work may result in electric shocks or fire.  
Consult the service shop where you bought the air conditioner.

## If one of the following symptoms takes place, call the service shop immediately.

- The power cord is abnormally hot or damaged.
- An abnormal sound is heard during operation.
- The safety breaker, a fuse, or the earth leakage breaker cuts off the operation frequently.
- A switch or a button often fails to work properly.
- There is a burning smell.
- Water leaks from the indoor unit.

Turn the breaker off and call the service shop.



■ **After a power failure**

The air conditioner automatically resumes operation in about 3 minutes. You should just wait for a while.

■ **Lightning**

If lightning may strike the neighbouring area, stop operation and turn the breaker off for system protection.

## Disposal requirements.

- Dismantling of the unit, treatment of the refrigerant, oil and eventual other parts, should be done in accordance with the relevant local and national regulations.

## We recommend periodical maintenance.

In certain operating conditions, the inside of the air conditioner may get foul after several seasons of use, resulting in poor performance. It is recommended to have periodical maintenance by a specialist aside from regular cleaning by the user. For specialist maintenance, contact the service shop where you bought the air conditioner. The maintenance cost must be borne by the user.

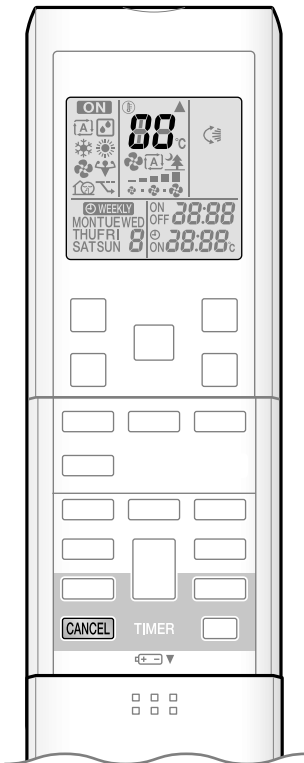

## ■ Fault diagnosis by remote controller

- In the ARC452A series, the temperature display sections on the main unit indicate corresponding codes.

**1.** When **CANCEL** is held down for 5 seconds, a “00” indication flashes on the temperature display section.

**2.** Press **CANCEL** repeatedly until a continuous beep is produced.

- The code indication changes as shown below, and notifies with a long beep.

	CODE	MEANING
SYSTEM	00	NORMAL
	UA	INDOOR-OUTDOOR UNIT COMBINATION FAULT
	U0	REFRIGERANT SHORTAGE
	U2	DROP VOLTAGE OR MAIN CIRCUIT OVERVOLTAGE
	U4	FAILURE OF TRANSMISSION (BETWEEN INDOOR UNIT AND OUTDOOR UNIT)
INDOOR UNIT	A1	INDOOR PCB DEFECTIVENESS
	A5	HIGH PRESSURE CONTROL OR FREEZE-UP PROTECTOR
	A6	FAN MOTOR FAULT
	C4	FAULTY HEAT EXCHANGER TEMPERATURE SENSOR
OUTDOOR UNIT	C9	FAULTY SUCTION AIR TEMPERATURE SENSOR
	EA	COOLING-HEATING SWITCHING ERROR
	E1	CIRCUIT BOARD FAULT
	E5	OL STARTED
	E6	FAULTY COMPRESSOR START UP
	E7	DC FAN MOTOR FAULT
	E8	OVERCURRENT INPUT
	F3	HIGH TEMPERATURE DISCHARGE PIPE CONTROL
	F6	HIGH PRESSURE CONTROL (IN COOLING)
	H0	SENSOR FAULT
	H6	OPERATION HALT DUE TO FAULTY POSITION DETECTION SENSOR
	H8	DC CURRENT SENSOR FAULT
	H9	FAULTY SUCTION AIR TEMPERATURE SENSOR
	J3	FAULTY DISCHARGE PIPE TEMPERATURE SENSOR
	J6	FAULTY HEAT EXCHANGER TEMPERATURE SENSOR
	L3	ELECTRICAL PARTS HEAT FAULT
L4	HIGH TEMPERATURE AT INVERTER CIRCUIT HEATSINK	
L5	OUTPUT OVERCURRENT	
P4	FAULTY INVERTER CIRCUIT HEATSINK TEMPERATURE SENSOR	

## NOTE

- A short beep and 2 consecutive beeps indicate non-corresponding codes.
- To cancel the code display, hold the **CANCEL** down for 5 seconds. The code display also cancel itself if the button is not pressed for 1 minute.

# **DAIKIN INDUSTRIES, LTD.**

Head office:

Umeda Center Bldg., 2-4-12, Nakazaki-Nishi,  
Kita-ku, Osaka, 530-8323 Japan

Tokyo office:

JR Shinagawa East Bldg., 2-18-1, Konan,  
Minato-ku, Tokyo, 108-0075 Japan  
<http://www.daikin.com>



The two-dimensional bar code is  
a manufacturing code.

3P278434-5C M16B096 (1608) HT