



MODEL: **SPJ-GDG-3EB-MARKER**
 MATERIAL: **Solid Brass**
 FINISH SHOWN: **Matte Bronze**
 ELECTRICAL: **8-15V, 120V**
 WATTAGE: **2W**
 ENGINE: **FB-2W-CYL-TA16**
 LUMENS: **150**
 OPTIC: **Flood**
 MOUNTING: **Recessed**

FINISHES

- Matte Bronze (MBR)
- Verde (V)
- Moss (M)
- Black (B)
- Rusty (R)
- Satin Brass (SB)
- Aged Brass (AG)
- Raw Copper (RC)
- Natural Copper (NC)

PVD PREMIUM

- PVD Polished (PVDP)
- PVD Satin (PVDS)
- PVD Graphite (PVDG)
- PVD Bronze (PVDBZ)
- PVD Black (PVDBL)

WATTAGE LUMENS

- 1W 80
- 2W 150
- 3W 200
- 6W 300

Custom lumen packages are available upon request

COLOR TEMPERATURE

- 2200K 5000K
- 2700K 6500K
- 3000K RGBW
- 4000K

Custom options are available

ELECTRICAL

- 8-15V 120V

OPTICS

- SPOT 19d
- FLOOD 38d
- WIDE FLOOD 54d
- WIDE ANGLE FLOOD 120d

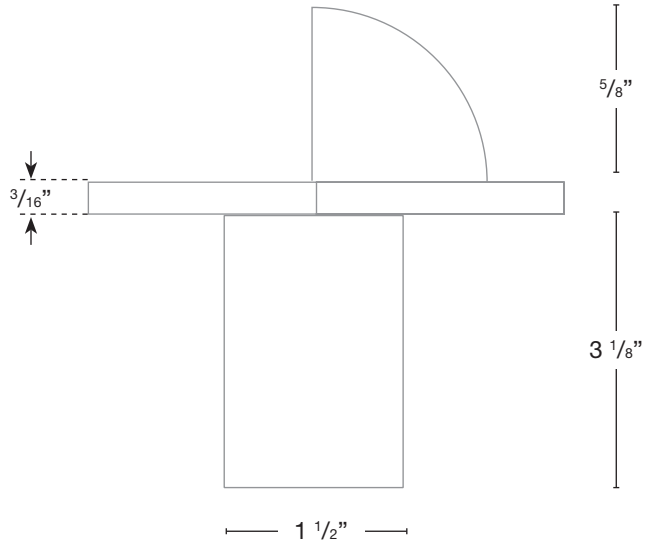
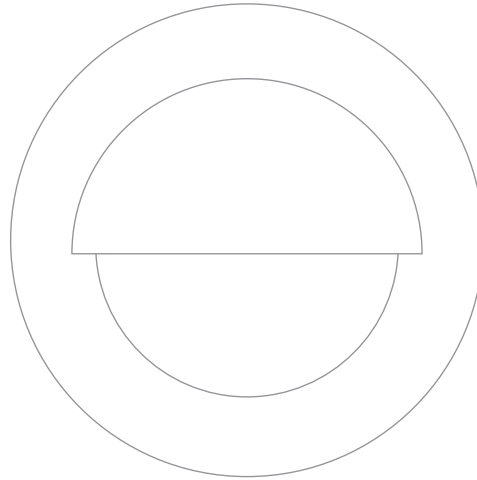

Concrete Pour Sleeve

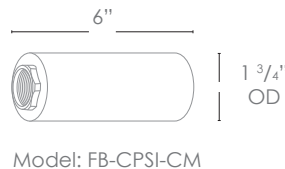
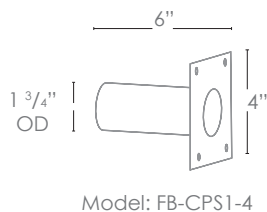
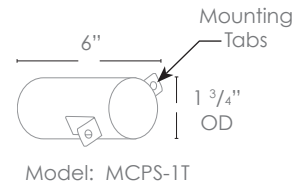
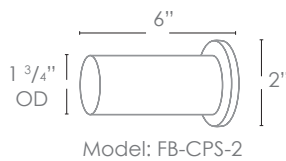
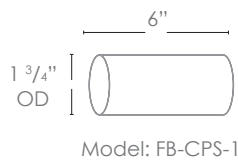

Wet Listed



Ordering Example

Customer Approval

Date

SPJ-GDG-3EB-MARKER-MBR-2W-27K-8-15V