

SPJ04-05

Garden Lantern

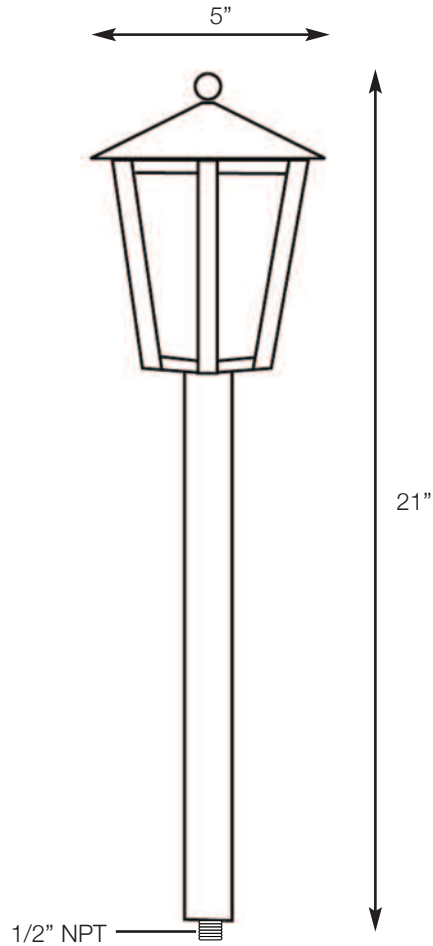

- MODEL:** SPJ04-05
- MATERIAL :** Solid Brass
- FINISH :** Specify
- GLASS :** Specify
- ELECTRICAL :** 12v or 120v
- SOCKET :** (1) Light Candelabra
- LAMP :** Specify
- MOUNTING :** 1/2" NPT Perma Post Recommended SPJ19-03

DRAWN BY: MMC

BASE DESIGN: SPJ

DATE: 01-10-10

SPJ LIGHTING INC.

2107 Chico Avenue
South El Monte, CA 91733
(800) 469-3637 FAX: (626) 433-4839