

PRODUCT: SPJ-PCL-B26-SM

WEIGHT: 20 lbs.



Wet Listed



QUANTITY: ___

CONCRETE COLOR:

- COAST
- CONCRETE
- CARBON
- CLAY
- BARK

CONCRETE TEXTURE:

- ETCHED
- POLISHED

LIGHT ENGINE:

- 2W 125 LUMENS
- 8W 300 LUMENS

SEALER: STD. SEALER 4200

GENERAL PRODUCT NOTES:

E = EXPOSED FINISHED SURFACE

INSTALLATION IS REQUIRED BY OTHERS.

ALL EDGES TO BE EASED.

MANUFACTURING TOLERANCE $\pm 1/4"$.

2700K STANDARD ELECTRICAL TEMPERATURE: 8-15V

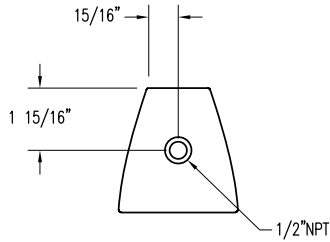

BOTTOM VIEW

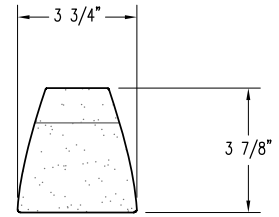

PLAN VIEW

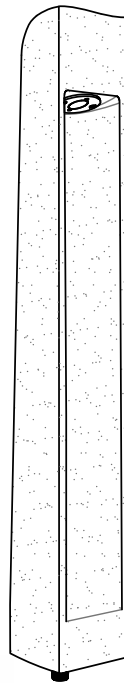

PERSPECTIVE VIEW

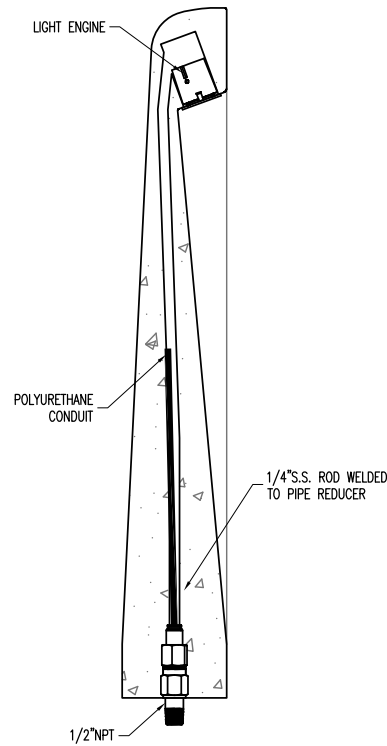

SECTION VIEW

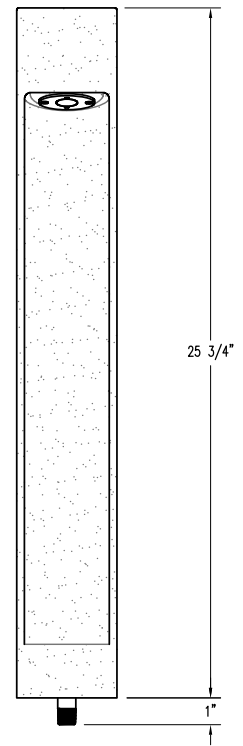

ELEVATION VIEW

<p>SPJ LIGHTING Inc. ARCHITECTURAL LANDSCAPE & OUTDOOR LIGHTING</p>	PLAN TYPE	CONSTRUCTION PLAN	DATE	FILE NO.	SHEET
	PRODUCT	SPJ-PCL-B26-SM PATHWAY LIGHT SURFACE MOUNT	11/2/20	008_ST-PL-B26-SM	1
	PROJECT NAME		SCALE	DRAWN BY:	OF
			2" = 1'	W.R.	2
			PC. NO.	QC ITEM NO.	



Wet Listed

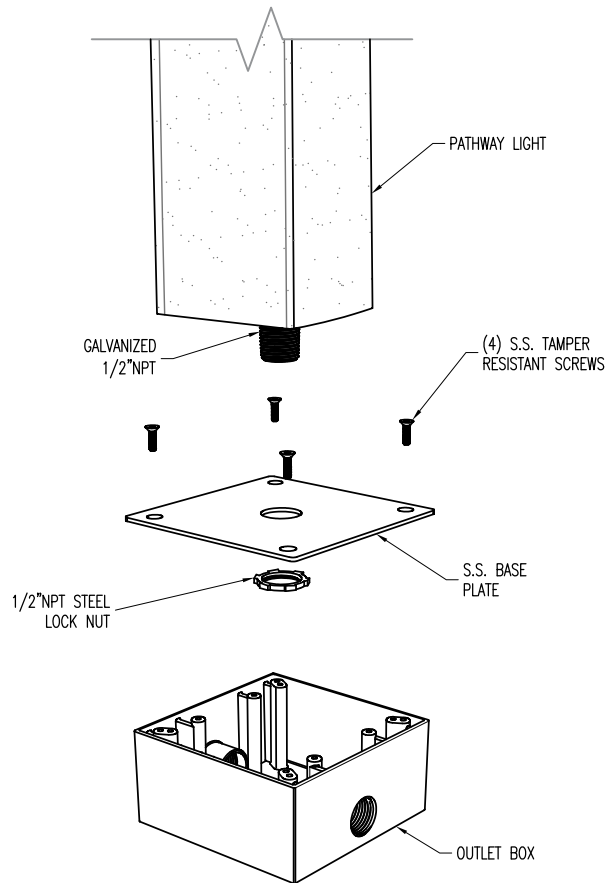

PERSPECTIVE VIEW
N.T.S.

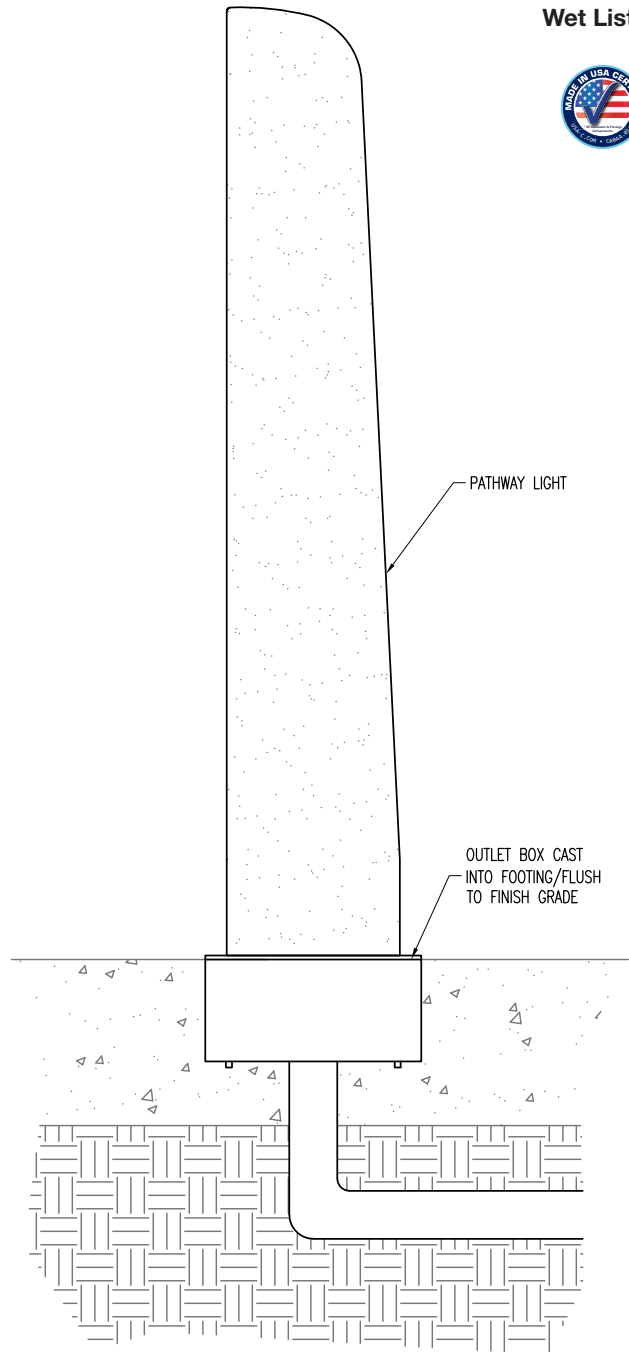

INSTALLATION SIDE VIEW
N.T.S.

<p>ARCHITECTURAL LANDSCAPE & OUTDOOR LIGHTING</p>	PLAN TYPE	INSTALLATION PLAN	DATE	FILE NO.	SHEET
	PRODUCT	SPJ-PCL-B26-SM PATHWAY LIGHT IN GROUND	11/2/20	008a_ST-PL-B26-SM	IN 2
	PROJECT NAME		SCALE	DRAWN BY:	OF
			3" = 1'	W.R.	2
			PC. NO.	QC ITEM NO.	