

PRODUCT: **PL-B20-IG**

WEIGHT: 15 lbs.



Certified by DarkSky.org

CONCRETE COLOR:

- COAST
- CONCRETE
- CARBON
- CLAY
- BARK

CONCRETE TEXTURE:

- ETCHED
- POLISHED

LIGHT ENGINE:

- 2W 125 LUMENS
- 8W 300 LUMENS

QUANTITY:     

SEALER: STD. SEALER 4200

**GENERAL PRODUCT NOTES:**

E = EXPOSED FINISHED SURFACE

INSTALLATION IS REQUIRED BY OTHERS.

ALL EDGES TO BE EASED.

MANUFACTURING TOLERANCE ±1/4".

2700K STANDARD ELECTRICAL TEMPERATURE: 8-15V

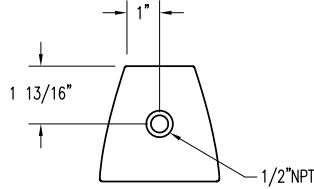

BOTTOM VIEW

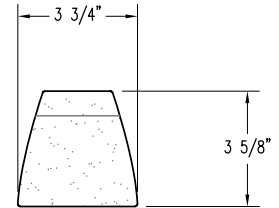

PLAN VIEW

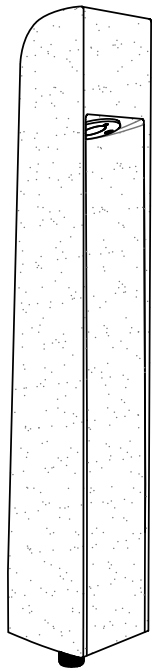

PERSPECTIVE VIEW

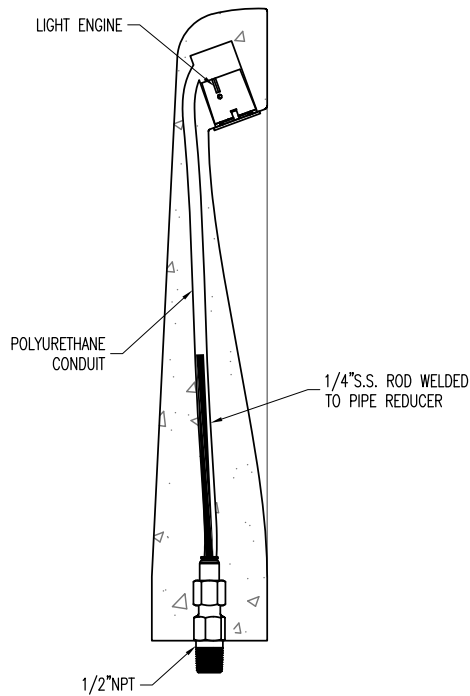

SECTION VIEW

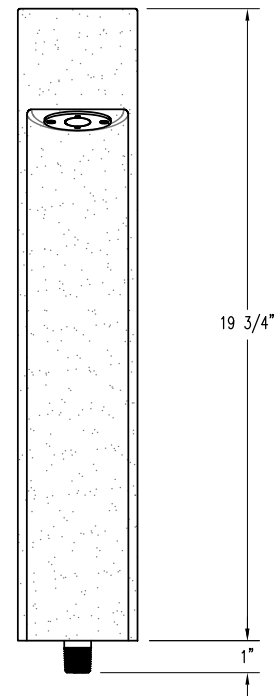

ELEVATION VIEW

**SPJ** LIGHTING Inc.  
ARCHITECTURAL LANDSCAPE & OUTDOOR LIGHTING

PLAN TYPE	CONSTRUCTION PLAN	DATE	11/2/20	FILE NO.	005_ST-PL-B20-IG	SHEET	1
PRODUCT	PL-B20-IG   PATHWAY LIGHT   IN GROUND	SCALE	2" = 1'	DRAWN BY:	W.R.	OF	2
PROJECT NAME		PC. NO.		QC ITEM NO.			

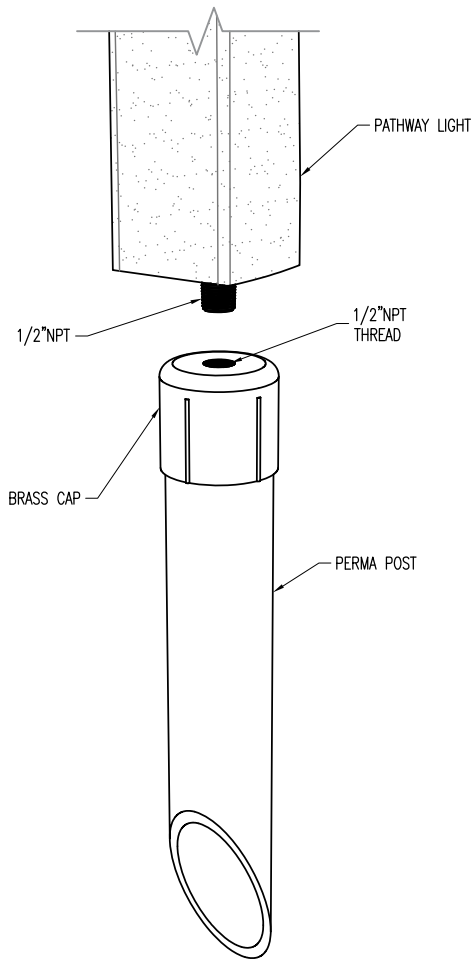

PERSPECTIVE VIEW  
N.T.S.

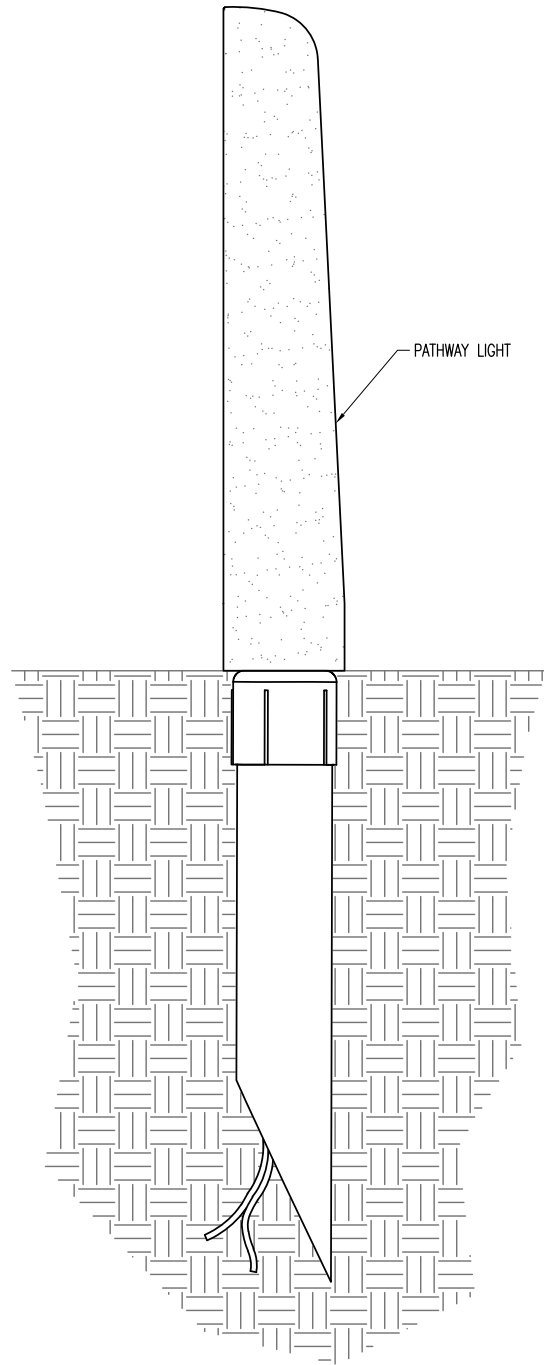

INSTALLATION SIDE VIEW  
N.T.S.

 ARCHITECTURAL LANDSCAPE & OUTDOOR LIGHTING	PLAN TYPE	INSTALLATION PLAN	DATE	FILE NO.	SHEET
	PRODUCT	PL-B20-IG   PATHWAY LIGHT   IN GROUND	11/2/20	005a_ST-PL-B20-IG IN	2
	PROJECT NAME		SCALE	DRAWN BY:	OF
			3" = 1'	W.R.	2
			PC. NO.	QC ITEM NO.	