

PRODUCT: SPJ-PCL-A18-IG

WEIGHT: 9 lbs.



Wet Listed



CONCRETE COLOR: COAST CONCRETE CARBON CLAY BARK
 CONCRETE TEXTURE: ETCHED POLISHED
 LIGHT ENGINE: 2W 125 LUMENS 8W 300 LUMENS
 QUANTITY: _____
 SEALER: STD. SEALER 4200

GENERAL PRODUCT NOTES:

E = EXPOSED FINISHED SURFACE
 INSTALLATION IS REQUIRED BY OTHERS.
 ALL EDGES TO BE EASED.
 MANUFACTURING TOLERANCE ±1/4".
 2700K STANDARD ELECTRICAL TEMPERATURE: 8-15V

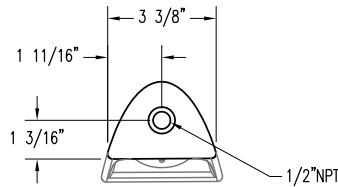

BOTTOM VIEW

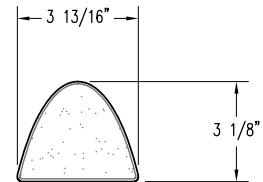

PLAN VIEW

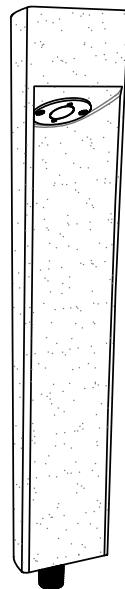

PERSPECTIVE VIEW

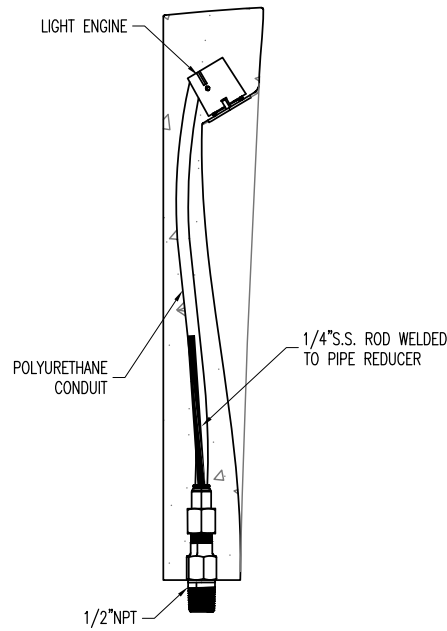

SECTION VIEW

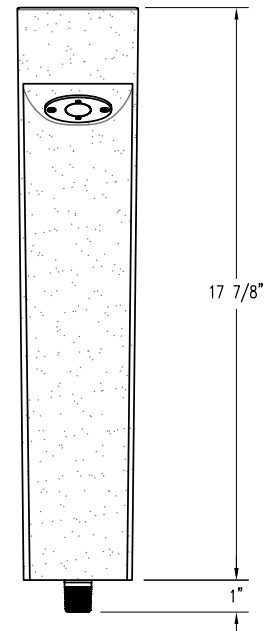

ELEVATION VIEW

<p>ARCHITECTURAL LANDSCAPE & OUTDOOR LIGHTING</p>	PLAN TYPE	CONSTRUCTION PLAN	DATE	11/2/20	FILE NO.	001_ST-PL-A18-IG	SHEET	1
	PRODUCT	SPJ-PCL-A18-IG PATHWAY LIGHT SURFACE MOUNT	SCALE	2" = 1'	DRAWN BY:	W.R.	OF	2
	PROJECT NAME		PC. NO.		QC ITEM NO.			



Wet Listed

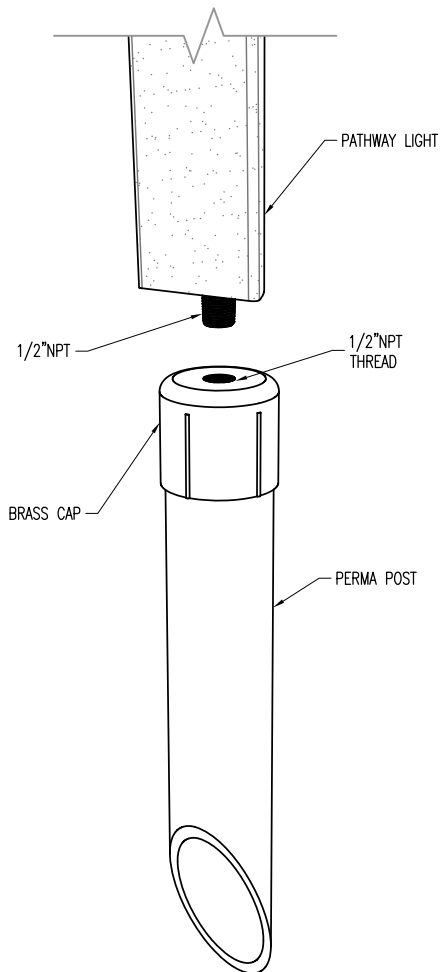

PERSPECTIVE VIEW
N.T.S.

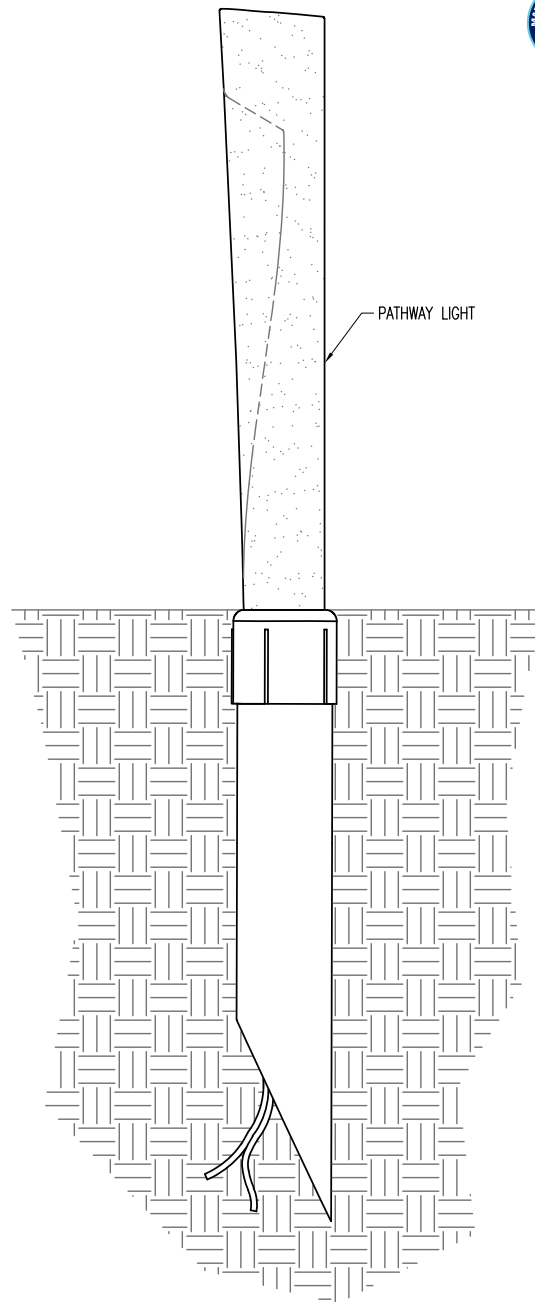

INSTALLATION SIDE VIEW
N.T.S.

<p>ARCHITECTURAL LANDSCAPE & OUTDOOR LIGHTING</p>	PLAN TYPE	INSTALLATION PLAN	DATE	FILE NO.	SHEET
	PRODUCT	SPJ-PCL-A18-IG PATHWAY LIGHT SURFACE MOUNT	11/2/20	001a_ST-PL-A18-IG IN	2
	PROJECT NAME		SCALE	DRAWN BY:	OF
			3" = 1'	W.R.	2
			PC. NO.	QC ITEM NO.	