

FLYBOX®



VOLT-AMP
(Omnia57 family)

**Installation and User Manual, Safety
Instructions and Warning Booklet**

**This product is not TSO'd and cannot be installed into
traditional FAA Part 23 and similarly Type-Certificate Aircraft**

Document A2019VOLT-AMP
Revision# 1.0, 02/2019
For firmware version 1.0

SECTIONS

INTRODUCTION

IMPORTANT NOTICE AND WARNINGS

INDEX

OMNIA57 FAMILY SYSTEM OVERVIEW

MECHANICAL INSTALLATION

ELECTRICAL INSTALLATION

INSTRUMENT SETTINGS

OPERATING INSTRUCTIONS

TECHNICAL SPECIFICATIONS

WARRANTY

DISCLAIMER

Examples of different configurations

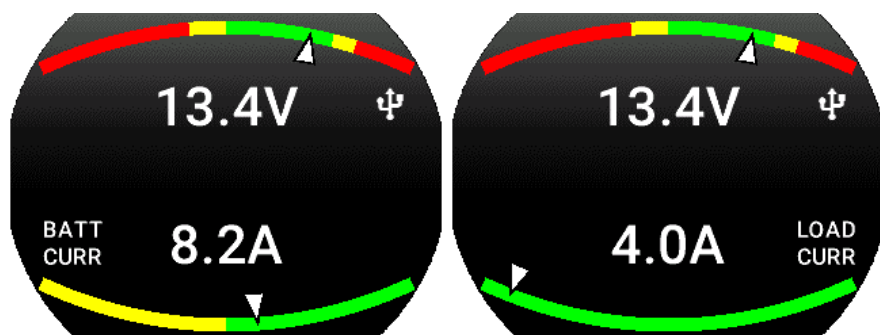
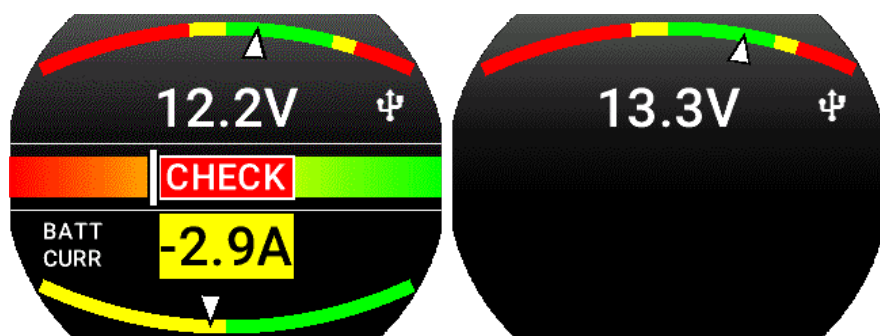
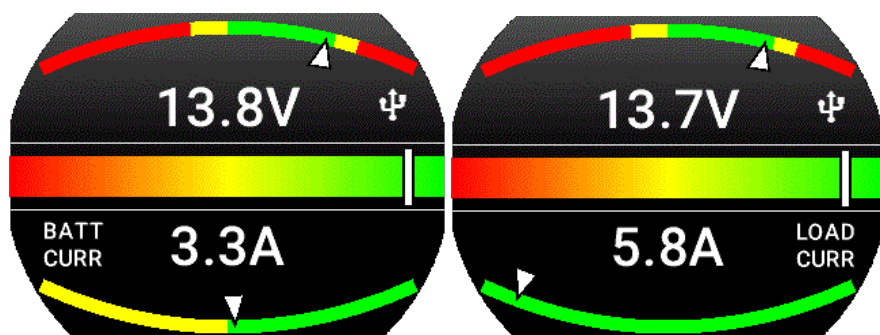

Thank you for purchasing a Flybox® **Omnia57** instrument.

Our intent in developing the **Omnia57** instrument family was to create a light and compact product, powerful and easy to install and use.

The **Omnia57** instrument family is equipped with a state-of-the-art highly visible display, a powerful 32 bit microcontroller and the latest generation of solid state sensors to ensure reliability and accuracy over time.

The owner has the possibility to keep the instrument software up-to-date by downloading the latest available revision from the www.flyboxavionics.it website and installing it using a USB pen drive.

We are confident our products will be satisfactory and will make your flying experience a pleasant one.

Symbols used in the Installation and User Manual, Safety Instructions and Warning Booklet



NOTE: Used to highlight important information.



CAUTION: Used to warn the user, it indicates a potentially hazardous situation or improper use of the product.



WARNING: Used to indicate a dangerous situation that can cause personal injury or death if the instruction is disregarded.



WARNING: These instructions must be provided to users before use, and retained for ready reference by the user. The user must read, understand (or have explained) and heed all instructions and warnings supplied with this product and with those products intended for use in association with it. Always keep a copy of the Installation and User Manual, Safety Instructions and Warning Booklet on the aircraft. In case of change of ownership, the Installation and User Manual, Safety Instructions and Warning Booklet must be delivered together with all of the other papers.



WARNING: Read the Installation and User Manual, Safety Instructions and Warning Booklet before installing the device on your aircraft and follow the procedure described therein.



WARNING: This device is intended to be installed on NON-TYPE CERTIFIED AIRCRAFT ONLY, as it does NOT require any air operator's certificate. Refer to your national aviation authorities to check if this device can be installed on your aircraft.



WARNING: It is the owner's responsibility to test this device before operating the aircraft and to make sure nobody is using it unless properly instructed and authorized to do so.



WARNING: Once the installation process is completed, it is extremely important to test the device before taking off to make sure it works properly. Therefore, we strongly suggest to double check all of the electronic instruments available on the aircraft and to turn them on to verify they function correctly.



WARNING: This device is operated through a software which from time to time can be updated and/or subject to change. Please, always refer to the Installation and User Manual, Safety Instructions and Warning Booklet for the last updated version of the software available at www.flyboxavionics.it



WARNING: It is the responsibility of the installer to properly install the device on the aircraft. In case of calibration, or any technical or functional customization of the device, the responsibility lies with the individual who carried out such operation.

FAILURE TO DO SO MAY RESULT IN SERIOUS INJURY
OR DEATH.



WARNING: If this product is not used correctly, or it is subjected to additions or alterations, the effectiveness of this device may be considerably reduced.



WARNING: Alterations, additions, or repairs not performed by the instrument manufacturer or by a person or organization authorized by the manufacturer shall negate any warranty.



WARNING: Do NOT rely on the Omnia57 Fuel L-P device ONLY to determine the level of the fuel available in the tanks.



WARNING: The unit isn't waterproof. Serious damage could occur if the unit is exposed to water or spray jets.



NOTE: The consumer decides of his own free will if the purchased product is suitable and safe for his need. If the consumer does not agree with the notices contained in this Installation and user Manual, Safety Instructions and Warning Booklet, do not install this instrument in his aircraft.



NOTE: Flybox Avionics reserves the right to change or improve its products as well as terms, conditions, and notices under which their products are offered without prior notice.



NOTE: The Installation and User Manual, Safety Instructions and Warning Booklet will be updated annually if needed.

All changes or updates will be published on our website www.flyboxavionics.com in the "support" section.



NOTE: Upon receipt of the instrument it is advisable to register on our website www.flyboxavionics.it in the "product registration" section.

The Registration data will be used only to send important news or information about available firmware updates or to communicate safety information about the instrument.

INDEX

SECTION 1 - Omnia57 Family System overview.....	1
1.1 - Construction Features	1
1.2 - Ergonomics.....	1
1.3 - Interconnection Ability	2
1.4 - Easy Software Update	3
1.5 - Easy Datalog Saving	3
1.6 - Interfaces	4
SECTION 2 - Mechanical installation.....	5
2.1 - Mechanical Dimensions.....	5
2.2 - Sensors Installation.....	7
SECTION 3 - Electrical Installation.....	8
3.1 - Rear Panel Connections.....	8
3.2 - 22 Pole Female Connector Wiring.....	9
3.3 - 22 Pole Connector Table.....	10
3.4 - Current Sensors Connections.....	11
3.5 - CAN bus Connection Wiring.....	14
3.6 - CAN Bus Connector Tables.....	15
SECTION 4 - Instrument settings.....	16
4.1 - Minimum Settings Before First Use.....	16
4.2 - Panel Indicators And Commands.....	17
4.3 - Setup Menu Navigation.....	18
4.4 - Main Setup Menu... ..	19
4.4.1 - Gauges Submenu.....	21

4.4.2 - Volt Submenu..... 22

4.4.3 - Ampere Submenu..... 26

4.4.4 - Indicator Mode..... 29

4.4.5 - Diagnostic Mode..... 30

4.6 - Offset 1 Calibration..... 33

4.7 - Offset 2 Calibration 35

4.8 - Backlight Submenu..... 37

SECTION 5 - Operating Instructions..... 40

5.1 - Firmware Upgrade..... 40

5.2 - Backup/Restore..... 43

5.3 - Use Of The Instrument..... 45

5.4 - Logger..... 48

TECHNICAL SPECIFICATIONS..... 49

CLEANING..... 49

WARRANTY..... 50

TERM OF USE AND DISCLAIMER..... 51

OMNIA57 FAMILY SYSTEM OVERVIEW

The **Omnia57** instrument family has many innovative features, common to all models as described below.

1.1 CONSTRUCTION FEATURES

Omnia57 instrument family is built from solid aluminum alloy, CNC milled and powder coated to last a long time over the years always showing a new appearance.

1.2 ERGONOMICS

- Large 2.4 inch TFT display, 320x240 Pixels, 1000 nits, antiglare surface, sunlight readable, wide temperature range.
- A high quality knob encoder with push button for easy access to all features.
- Backlight auto dimming feature with one optional sensor for all the Omnia57 installed in the panel.

1.3 INTERCONNECTION ABILITY

All the instruments of the **Omnia57** family can be connected together to form a communication network, making some data exchange operations simpler.

The software update of a **Omnia57** instrument connected in group takes place through the CAN bus communication with the instrument that has the USB pen drive connected. This means that the USB connection is made to a single instrument, and the information will be forwarded via CAN bus to or from all the others in the group.

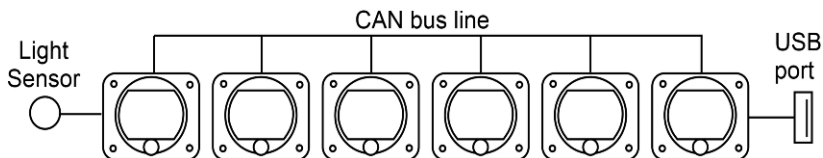

Up to 16 Omnia57 can be connected together through the CAN 1 bus.

The configuration data and the data logger of the interconnected instruments are saved or restored via CAN bus on the same USB pen drive. A single brightness sensor can provide information to all the connected instruments to automatically adjust the backlight intensity.

1.4 EASY SOFTWARE UPDATE

The user can download any new firmware, when available, from Flybox website, connect a USB pen drive to the instrument and freely update it with the last features.

With one USB connection only, it will be possible to update every instrument installed in the panel. If more Omnia57 are installed and properly connected, they will search for the right firmware through the CAN bus.

1.5 EASY DATALOG SAVING

Easy logging of the data for debug purpose. If needed, each **Omnia57** unit can save a last flight log on the USB pen drive. The user can then send the log via e-mail to Flybox support for a help/support request.

1.6 INTERFACES

All the **Omnia57** instruments have the following common interfaces:

2 separate CAN BUS: they can be used to connect the **Omnia57** instruments together, to interface them with other Flybox instruments or with external devices like Engines ECUs or new devices that will be possibly developed in the future.

2 RS232 serial ports: used to connect the **Omnia57** instruments to an external GPS (when applicable). This feature appears in some models only.

1 Sensor Light Input: if connected, it allows the automatic light intensity adjustment, one sensor for all the instruments.

2 Power outputs for sensors: one 12 V 500mA@60°C and the other 5 V 350 mA@60°C, both protected from short circuit.

If the current on one of the outputs is too high, a caution message will appear.

Caution!
High current PIN 2

1 Alarm output: all the **Omnia57** instruments can activate an external warning device like a lamp or a small relay through this NPN transistor output.

Omnia57 VOLT-AMP - Installation and User Manual,
Safety Instructions and Warning Booklet

MECHANICAL INSTALLATION

2.1 MECHANICAL DIMENSIONS

The **Omnia57 Fuel VOLT-AMP** instrument fits in a standard 2 ¼" (57 mm) panel cutout; it's recommended to choose a position that permits optimal display visibility. It's furnished with four M4 screws to install it to the panel, if you use other screws consider that the maximum thread length inside the instrument body is 10mm (see the picture below).

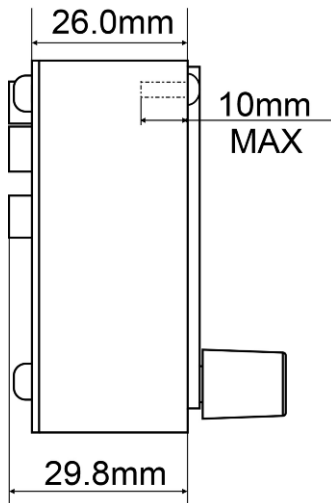

Omnia57 VOLT-AMP - Installation and User Manual,
Safety Instructions and Warning Booklet

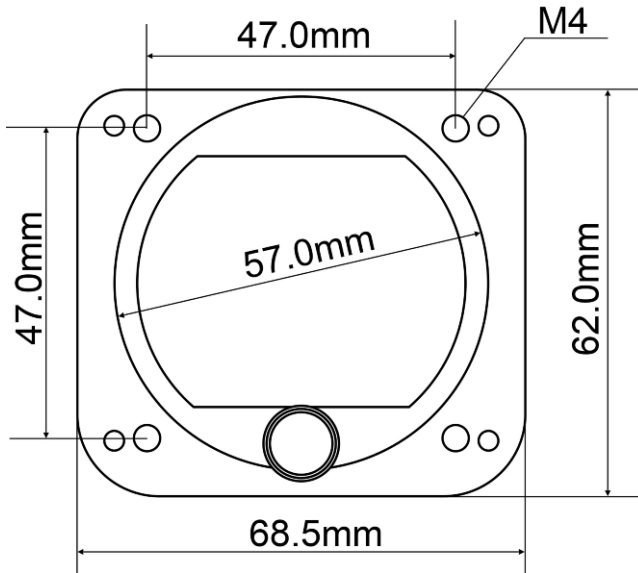

NOTE: For an installation without interference, consider making a hole of at least 57.5 mm diameter

2.2 SENSORS INSTALLATION

Omnia57 VOLT-AMP has 3 analog inputs. One is for a Voltage source and two can read one or two Flybox current sensors code 601060 and 601061.

The voltage input can be connected to the +V bus behind the instrument panel or directly to the battery. Connection through 1 A fuse is recommended.

The Flybox current sensors are supplied bare and must be installed insulating them from other metallic parts and protected from moisture.

Usually they are installed behind the instrument panel or in the engine compartment and covered by a simple plastic sheet or cover.

Another way to insulate them is using a piece of shrinking tube.

ELECTRICAL INSTALLATION

3.1 REAR PANEL CONNECTIONS

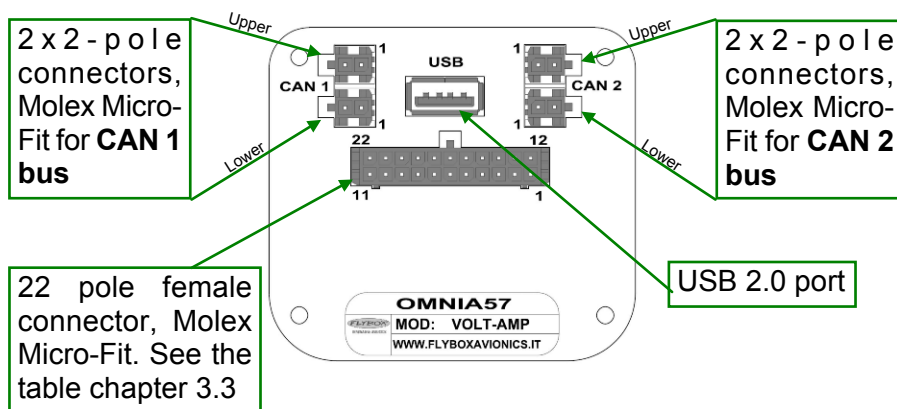

The required connectors and terminals are supplied with the instrument.

The manufacturer's codes are:

- Molex P/N 43025-0200 (2 pole housing)
- Molex P/N 43025-2200 (22 pole housing)
- Molex P/N 43030-0007 (female crimp terminal)

The terminals can be crimped with:

- Flybox Professional Crimping Tool cod. 603000
- Molex tool P/N 63819-0000

Omnia57 VOLT-AMP - Installation and User Manual,
Safety Instructions and Warning Booklet

3.2 - (22 POLE) FEMALE CONNECTOR WIRING

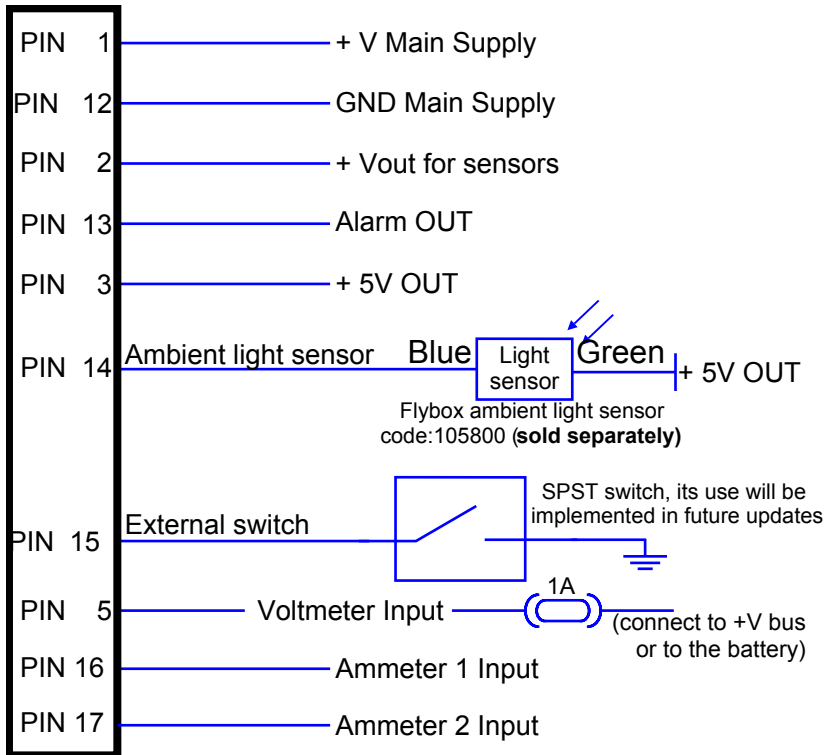

⚠ WARNING: Voltage peaks on the supply line exceeding the operating limits can damage the device.

Omnia57 VOLT-AMP - Installation and User Manual,
 Safety Instructions and Warning Booklet

3.3 - (22 POLE) CONNECTOR TABLE

PIN	I/O	Signal
1	I	+V Main supply, 10-30Vdc, with a proper breaker
2	O	Vout for sensors, it delivers the same voltage supplied on the Pin 1, short circuit protected and limited to 500mA
3	O	5V out for sensor, short circuit protected and limited to 350mA
5	I	Voltmeter input (connect to the battery or the Main +V bus through 1A fuse)
12	I	GND main supply
13	O	Alarm Out, NPN 300 mA (not protected)
14	I	Ambient light sensor input
15	I	External switch
16	I	Ammeter 1 input (Battery Current Only)
17	I	Ammeter 2 input (Loads Current Only)

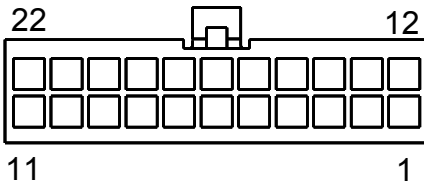

Molex P/N 43025-2200 (22 pole housing). View from wire insertion side.

3.4 CURRENT SENSORS CONNECTIONS

The sensor measure the current flowing through the A+/A- poles in both direction. Use a cable of suitable section and power terminals suitable for the sensor.

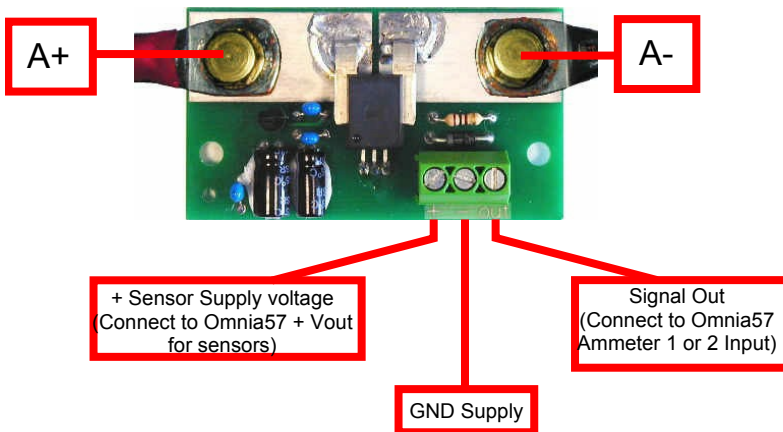

NOTE 1: use sensors which support the voltage supplied to PIN 1 only.

Two models from Flybox are available

Code 601060: +/- 50A 15V max

Code 601061: +/- 50A 30V max

Omnia57 VOLT-AMP - Installation and User Manual,
Safety Instructions and Warning Booklet

The current sensor supplied by Flybox® is able to measure current between -50 and +50 Amperes. It must not be installed between battery and starter circuit because of the high current flowing into this path. The current sensors can be installed in these two positions as shown in the simplified electrical diagram below:

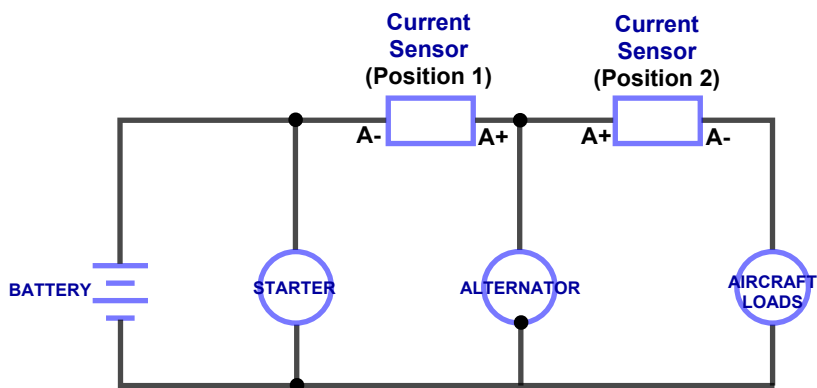

Position 1: in this position the current sensor measures current flow into or out of your battery (indicator show both positive and negative currents).

Position 2: in this position the current sensor measures the current flowing into the aircraft loads.

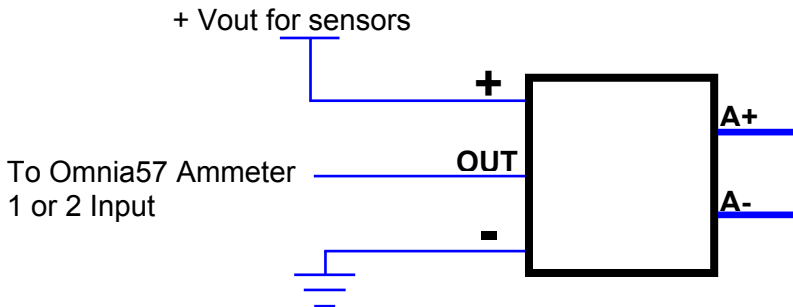

Flybox Ammeter sensor connection.

Optional Ammeter sensor
Flybox code: 601060, 601061 (**sold separately**)



WARNING: Secure all wires securely and check that non-insulated terminals cannot touch or short-circuit other metal objects in the aircraft. Improper installation of the ammeter shunt may result in high current flow, electrical system failure, or fire.

3.5 CAN BUS CONNECTION WIRING

Pin 2  Molex P/N 43025-0200 (2 pole housing). View from wire insertion side
Pin 1 

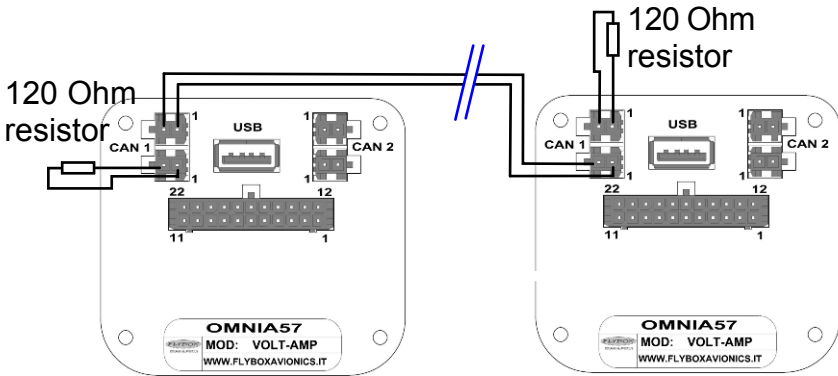

CAN bus Wiring Information

The basic electrical architecture of a CAN bus consists of a single twisted or shielded wire pair with a device connected at each end. Each end must be terminated with a 120 ohm resistor, Flybox code 105810. Up to 16 Omnia57 can be connected together through CAN 1 bus. Ready-made termination resistors and wiring for connecting several Omnia57 together are available in different lengths: 25cm, 50cm, 100cm.

See the website www.flyboxavionics.it for details and how to order.

Omnia57 VOLT-AMP - Installation and User Manual,
Safety Instructions and Warning Booklet

3.6 - (2 POLE) CAN BUS CONNECTOR TABLES

PIN	I/O	Signal
1	I/O	CAN 1 H Internally connected with the Pin 1-CAN 1 H (Lower connector)
2	I/O	CAN 1 L Internally connected with the Pin 2-CAN 1 L (Lower connector)

2 Pole **CAN 1** Lower Connector

PIN	I/O	Signal
1	I/O	CAN 1 H Internally connected with the Pin 1-CAN 1 H (Upper connector)
2	I/O	CAN 1 L Internally connected with the Pin 2-CAN 1 L (Upper connector)

2 Pole **CAN 2** Upper Connector

PIN	I/O	Signal
1	I/O	CAN 2 L Internally connected with the Pin 1 CAN 2 L (Lower connector)
2	I/O	CAN 2 H Internally connected with the Pin 2 CAN 2 H (Lower connector)

2 Pole **CAN 2** Lower Connector

PIN	I/O	Signal
1	I/O	CAN 2 L Internally connected with the Pin 1 CAN 2 L (Upper connector)
2	I/O	CAN 2 H Internally connected with the Pin 2 CAN 2 H (Upper connector)

INSTRUMENT SETTINGS

4.1 MINIMUM SETTINGS BEFORE FIRST USE



CAUTION: Before using the **Omnia57 VOLT-AMP** in flight for the first time, you must set at least the following parameters (as explained in the instructions on the following pages):

- Set the thresholds for the Volt gauge.
- Set the alarms parameters for the Volt gauge.
- Enable the Ampere gauge if you want to activate it.
- If using the Ampere gauge, enabled the used sensors.
- Set the mode for the AMP gauge.
- For the AMP gauge set the startup parameter.
- For the AMP gauge set the Offset parameter for all the enabled sensors.
- Check if the indications are correct for all the enabled gauges.



WARNING: In the absence of the above operations, or if they are not performed correctly, you can not consider as reliable the indications of the instrument.

4.2 PANEL INDICATORS & COMMANDS

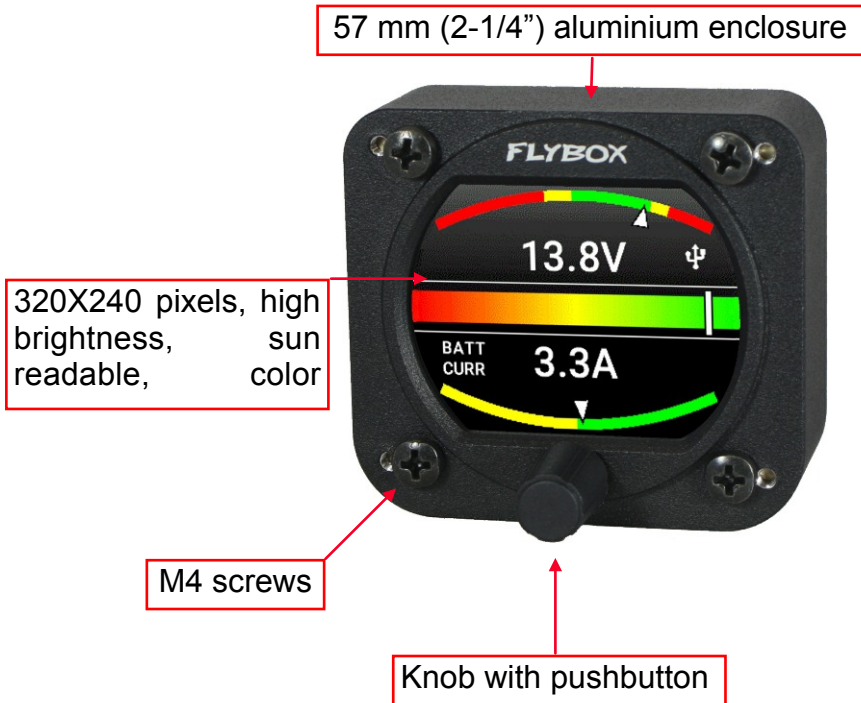

The knob can be rotated to select the functions and increment or decrement the values while pressing it to confirm.

4.3 SETUP MENU NAVIGATION

Navigation through the menus is very simple and fast using the knob:

- Press the knob for 1 second to enter in the Setup Menu. The menu automatically disappears if you don't press or rotate the knob for 5 seconds.
- Rotate the knob to navigate through menus and submenus items.
- The setup system is organized in menus and submenus; a submenu is a term used to describe a menu that is contained within another menu.
- Press the knob to enter in the selected item.
- The knob can be rotated to select the functions and increment or decrement the values while pressing it to confirm. To exit without changing while editing a number or multiple choice, keep pressed the knob for 3 seconds.
- The first items on every menu are Exit or Back. "Exit" is used to quit the Setup and go directly to the main screen, "Back" is used to go back to the previous level.

4.4 MAIN SETUP MENU

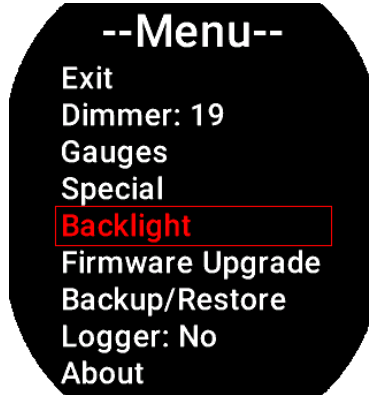

Exit: confirm to “exit” from the setup menu and go back to the main screen.

Dimmer: adjust display brightness from 1 (min brightness) to 19 (max brightness). Default value=19. The adjustment works both in Manual or in Automatic mode.

Gauges: select to set the 4 tanks gauge setup and the fuel pressure gauge setup. Go to chapter **4.4.1** for a full description.

Special: enter to restore the default settings. **Caution:** This operation returns the instrument to the factory settings. All settings, except for calibration data, will be erased. **It will require double confirmation.**

Backlight: set the backlight in “Manual” or “Automatic” mode. Go to chapter **4.8** for a full description.

Firmware Upgrade: enter to upgrade the firmware. Go to chapter **5.1** for a full description.

Backup/Restore: enter to save and load settings. Go to chapter **5.2** for a full description.

Logger: enable to save a flight session data. Go to chapter **5.4** for a full description.

About: enter to see instrument information.



About Page Example

4.4.1 Gauges Submenu



Back: confirm to go back to previous menu.

Exit: confirm to go directly to the main screen.

Volt: enter to setup the Voltmeter parameters. Go to chapter **4.4.2** for a full description.

Ampere: enter to setup the Ampmeter parameters. Go to chapter **4.4.3** for a full description.

4.4.2 Volt Submenu



Back: confirm to go back to previous menu.

Exit: confirm to go directly to the main screen.

Filter: set the fluctuation speed of the fuel level readings.

Default = 10

Min = 1 (faster)

Max = 100 (slower)

Thresholds: set all the thresholds for the Volt gauge.

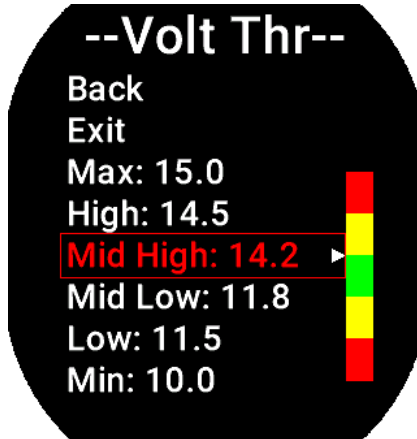

Rotate the knob to highlight the threshold you want to change, push and change the value, push again to confirm.



NOTE: Start to change the maximum threshold and then the lower threshold.



NOTE: To make a colored portion disappear, give the same value to the low and high thresholds of that color.



CAUTION: The Voltmeter is set to default values that may not be suitable for your system. The values set are for a 14V installation. It is mandatory to check the set values and eventually modify them according to your needs.

Alarms: enter to go to the alarm menu.

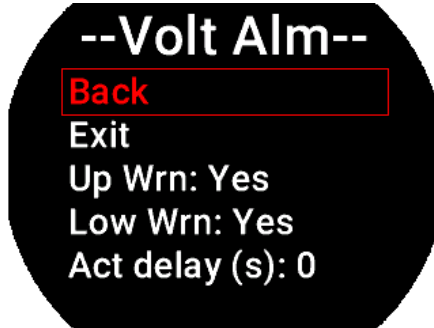

Back: go back to previous menu.

Exit: confirm to go directly to the main screen.

Up Wrn: select “Yes” to enable or select “No” to disable the High threshold alarm output.

Low Wrn: select “Yes” to enable or select “No” to disable the Low threshold alarm output.

Act delay: Select a delay in seconds before the alarm is triggered. When a warning threshold is reached, the alarm output will be activated after the set time. This option can be useful to avoid continuous alarms when the measured value is close to the set threshold value.

Default = 0s
Min = 0s (faster)
Max = 10s (slower)

Omnia57 VOLT-AMP - Installation and User Manual,
Safety Instructions and Warning Booklet

The alarm is only triggered if the Warning parameter is set to "Yes". The alarm event triggers both the flashing message on the screen and the alarm output. Both can be reset by pressing the knob but the rectangle behind number remains in red.

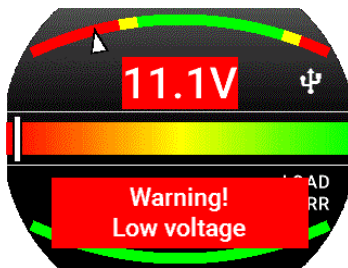

Before resetting



After resetting with the knob

4.4.3 Ampere Submenu

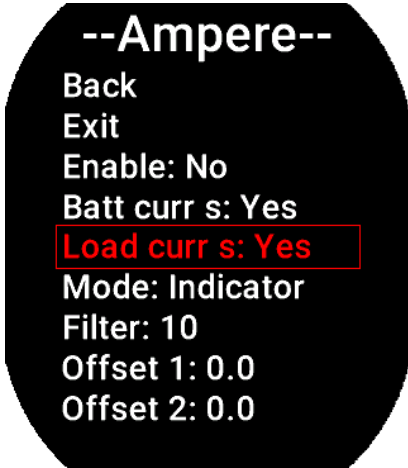

Back: confirm to go back to previous menu.

Exit: confirm to go directly to the main screen.

Enable: select “Yes” to enable all the Ampere gauges, “No” to disable them.



NOTE: Each time a new gauge is enabled this message will appear to remind the installer that it is his responsibility to make the correct settings before continuing.



Push and accept to continue.

Batt current s: select “Yes” if a Battery Current sensor is installed, “No” if not installed. See the **Table n. 1** for a full description.

Load current s: select “Yes” if a Battery Current sensor is installed, “No” if not installed. See the **Table 1** for a full description.

Mode: set this parameter to “Indicator” or “Diagnostic” mode. Go to chapters **4.4.4** and **4.4.5** for a full description.

Startup: this parameter will be visible only if “Battery current” and “Load current” are both enabled. It specifies which of the 2 to show when the instrument is switched on.

Filter: set the fluctuation speed of the current readings.

Default = 10



Min = 1 (faster)

Max = 100 (slower)

Offset 1: set the Offset value for the Ammeter 1. Go to chapter **4.6** for a full description.

Offset 2: set the Offset value for the Ammeter 2. Go to chapter **4.7** for a full description.

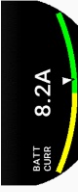
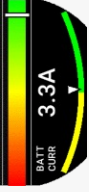
Table 1

Amperometer Gauge Functions	Sensor probe required on Input 1	Sensor probe required on Input 2	Graphic representation
- Indicator Loadmeter - (Measure the Loads current)		YES	
- Indicator Ammeter - (Measure Battery current)	YES		
- Diagnostic - (Diagnoses the state of the electrical power)	YES		
- Diagnostic + Loadmeter - (Diagnoses the state of the electrical power + measure the loads current)	YES	YES	

4.4.4 "Indicator" mode

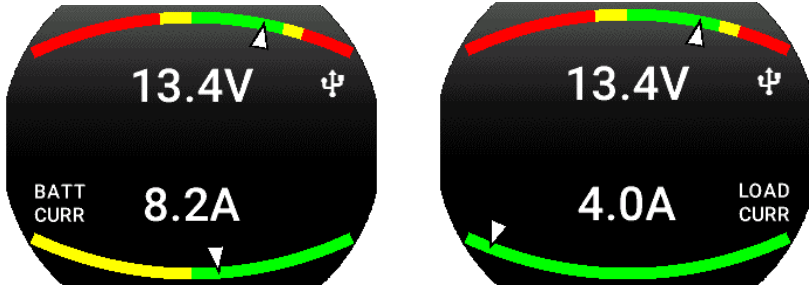

If the "indicator" mode is selected, the ammeters indication are as in the figures above. The indicators are equivalent to a traditional ammeter, without any alarm and any diagnostic function.

It will be possible to install only the battery current indicator or the load current indicator or both.

If both current sensors are installed, it will be possible to display one or the other by turning the knob to the right or to the left.

4.4.5 "Diagnostic" mode

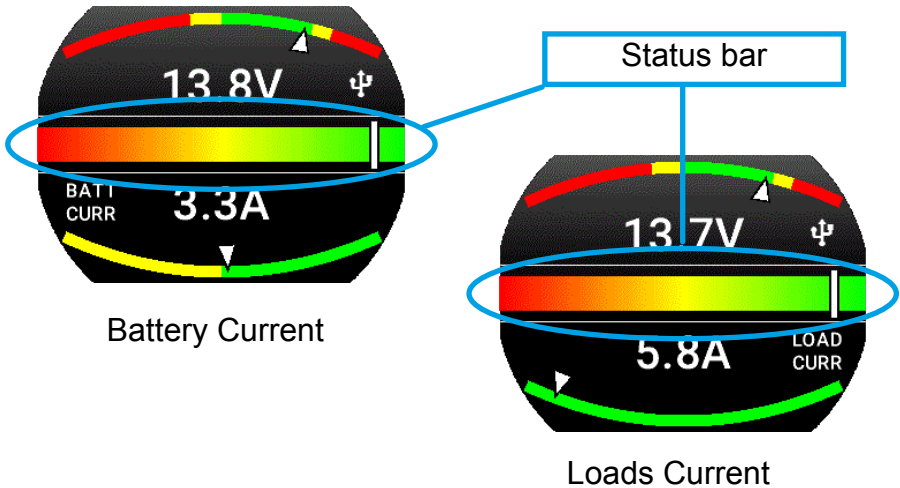

If the "Diagnostic" mode is selected, the ammeters indication are as in the figures above.

A central coloured bar appears, representing the health state of the on-board electrical system.

If both current sensors are installed, it will be possible to display the battery current or the loads current by turning the knob. If only one current sensor is installed, rotating the know will have no effect.

Important considerations

In Diagnostic mode, the instrument allows to monitor both the voltage and the current flow into or out of the battery. These are represented by the upper and lower arc (when it's showing the Ammeter) respectively.

These two measures can provide important information on the state of health of the electrical system if analyzed with a good algorithm as in the case of **Omnia57 VOLT-AMP**.

If the status bar needle moves but still remains in the green arc, the system is functioning correctly.

If any of the 3 needles moves towards its yellow or red zone, it indicates a probable malfunction and it is therefore advisable to investigate the possible causes of the anomaly.



CAUTION: When the flashing word "CHECK" appears in the central bar, it means that the battery is supplying current to the loads that for some reason are no longer supplied by the on-board generator. In this situation, the battery charge is destined to drop dramatically, according to the status and efficiency of the battery and proportionally to the active loads.

In a electrical system there can be many variables such as the type of generator and regulator, the type of battery (lead, lithium, other), the state of charge of the battery itself and others.

Keep in mind that for these reasons, the system does not give absolute indications of a malfunction, however, if the indicator of the central bar moves to the yellow area, with reasonable certainty you may have a problem that must be better investigated.



NOTE: Given the flat discharge curve of the lithium batteries, the diagnosis system may not be particularly efficient with these because the voltage remains at its rated value until shortly before the charge is exhausted and the voltmeter remains at correct values until the last moment.

4.6 Offset 1 calibration

To achieve maximum accuracy in current measurements, it may be necessary to perform a calibration of the current sensor. The calibration will correct any differences that may exist between different sensors and wiring.

Follow these steps:

1 - Connect only the 3 wires (+, -, OUT) from the current sensor to the instrument, leaving disconnected the 2 power cables "A+" and "A-".

2 - Now it's required to turn-on the instrument, so temporarily connect together the two cable disconnected from "A+" and "A-". Be careful to isolate them from metal objects while performing the calibration.

3 - Turn-on the instrument and read the numeric value for the battery current indicator. If it's zero there is no need to calibrate the Offset 1.

4 - If it's different from zero, go to **SETUP > GAUGE > AMPERE > Offset 1** and click the knob.

A message indicating you are modifying the offset will appear, confirm "YES". The new Offset is now set.

5 - Return to the main screen and check if the procedure has taken effect. On the ammeter you should read zero.

6 - Turn-off the **Omnia57 VOLT-AMP** and restore the harness reconnecting the two cables “A+” and “A-” to the current sensor.

Below is an example of a calibration screens

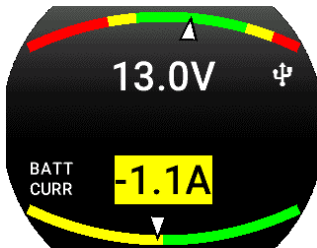

The ammeter shows an incorrect offset of -1.1A while it should be 0.



During the calibration process the message shows that an Offset of 1.1A is being set. Confirm “Yes” to proceed.

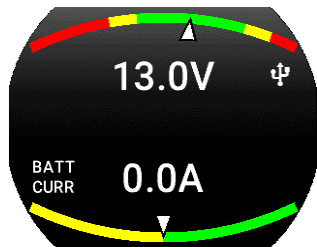

After calibration of the offset, the display is now correct.

Omnia57 VOLT-AMP - Installation and User Manual,
Safety Instructions and Warning Booklet

4.7 Offset 2 calibration

To achieve maximum accuracy in current measurements, it may be necessary to perform a calibration of the current sensor. The calibration will correct any differences that may exist between different sensors and wiring.

Follow these steps:

1 - Connect only the 3 wires (+, -, OUT) from the current sensor to the instrument, leaving disconnected the 2 power cables "A+" and "A-".

2 - Now it's required to turn-on the instrument, so temporarily connect together the two cable disconnected from "A+" and "A-". Be careful to isolate them from metal objects while performing the calibration.

3 - Turn-on the instrument and read the numeric value for the current indicator. If it's zero there is no need to calibrate the Offset 2.

If it's different from zero, go to **SETUP > GAUGE > AMPERE > Offset 2** and click the knob.

A message indicating you are modifying the offset will appear, confirm "YES". The new Offset is now set.

4 - Return to the main screen and check if the procedure has taken effect. On the loadmeter you should read zero.

5 - Turn-off the **Omnia57 VOLT-AMP** and restore the harness reconnecting the two cables “A+” and “A-” to the current sensor.

Below is an example of a calibration screens

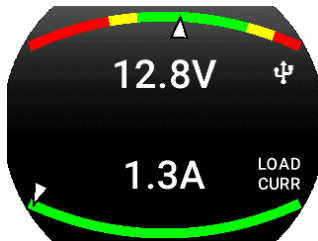

The loadmeter shows an incorrect offset of +1.3A while it should be 0.



During the calibration process the message shows that an Offset of -1.3A is being set. Confirm “Yes” to proceed.

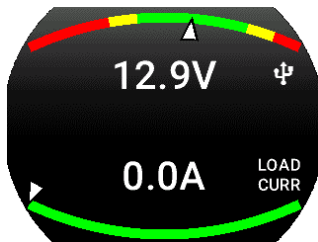

After calibration of the offset, the display is now correct.

4.8 Backlight Submenu



Back: go back to previous menu.

Exit: confirm to go directly to the main screen.

Mode: select to chose from “Manual” and “Auto”. When in “Manual” mode, the brightness can be changed with the dimmer function from the main menu, from 1 (min brightness) to 19 (max brightness). Default value=19. Selecting “Auto” new parameters will appear in the list:

Source: set how the instrument reads the ambient brightness. Choose "Sens" to read the brightness from the sensor connected to the instrument itself or "CAN" to read the ambient brightness from the CAN bus if the brightness sensor is connected to another Omnia57 instrument connected in cluster.

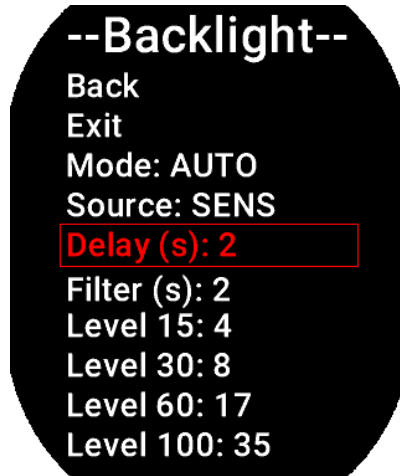

Delay (s): It introduces a delay to the variation of the backlight, it can be useful to avoid continuous changes in brightness when the sensor is hit by light and shadow alternately.

Default= 2 s
Min= 1 s (faster)
Max= 10 s (slower)

Filter (s): The filter slows down the response to changes in external brightness, it raises the value to slow down, lowers it to speed them up.

Default = 2 s
Min = 1 s (faster)
Max 30 s (slower)

This function assigns the amount of light read by the sensor to the target brightness (Level 15 = 15% brightness).

Once all 4 points have an assigned value, the brightness will change according to the amount of light read, interpolating it between the segments that are created.

Level 15: 4

Level 30: 8

Level 60: 17

Level 100: 35

Defaults values

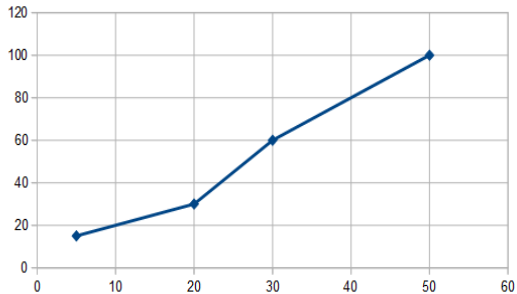

OPERATING INSTRUCTIONS

5.1 FIRMWARE UPGRADE

The **Omnia57 VOLT-AMP** software can be easily updated with new versions, when available. To check if a new software version is available, see www.flyboxavionics.it under support > software page.

Download the new version and after unpacking it, copy it to a USB stick, possibly free from other files.

To update the instrument it is necessary to connect the USB stick to the instrument you want to update or to any other instrument of the Omnia57 series installed and clustered via the CAN bus, following the procedure below:

- connect the usb stick to the instrument
- From the main menu of the instrument you want to upgrade select “Firmware Upgrade”.

If the USB stick is not yet plugged-in, a message advising you to insert will appear:



Omnia57 VOLT-AMP - Installation and User Manual,
Safety Instructions and Warning Booklet

If already plugged-in, a message indicating the file and the version will appear:



Select and confirm the software you want to write, the following screen will appear:



In case you are installing a version prior to the installed one, a different message will inform that you are **downgrading** and not upgrading the software. Confirm "Yes" to proceed, "No" to exit without writing any software.

(DEV. NAME) is the name of the instrument being update.

Wait until this message will appear and then remove the USB stick. The instrument will reboot with the new software.



Note: if the USB stick is installed on a device other than the one you are updating, the following messages will appear on the 2 devices:

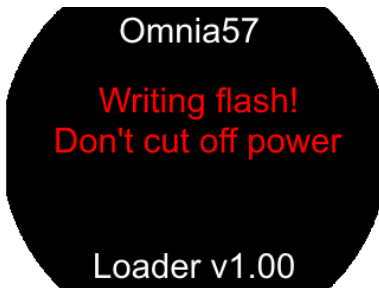

Device is being Update

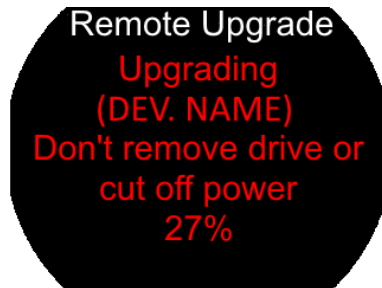

Remote device where the USB is connected

5.2 Backup / Restore

All set parameters and calibrations made in the instrument can be saved in a backup file. This can be useful if you need to restore all the parameters in a new instrument, for example in case of replacement, or if you need help from the instrument manufacturer. In this case, simply send the backup file saved on the USB stick to the Flybox support service. To backup or restore the parameters it is necessary to connect a USB stick to the instrument you want to backup/restore or to any other instrument of the Omnia57 series installed and clustered via the CAN bus.

From the main menu of the instrument you want to backup or restore the parameters, choose “Backup/Restore”. If the USB stick is not plugged-in yet , a message advising you to insert it will appear



Select “Backup” and push the knob to write the file on the USB stick. When the file is written, this message will appear:

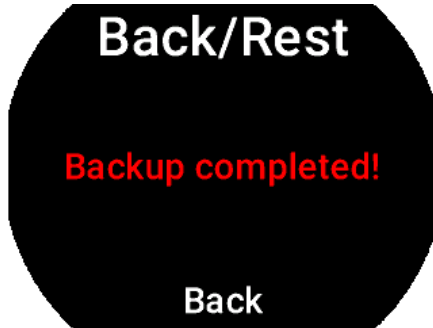

Select “Restore” and push the knob to load the previously saved parameters into the instrument.



Push the knob to reboot, the new parameters are now loaded in the instrument.

5.3 USE OF THE INSTRUMENT

When switched-ON, the display will immediately show the main page with the enabled gauges.



NOTE: The first time you switch-ON the **Omnia57 VOLT-AMP**, only the Voltmeter gauge is enabled. If you want to use the Ammeters too, you need to enable and calibrate them as explained in chapters **4.4.3** to **4.7**.

The following example refers to the complete installation of battery current sensor and load current sensor.

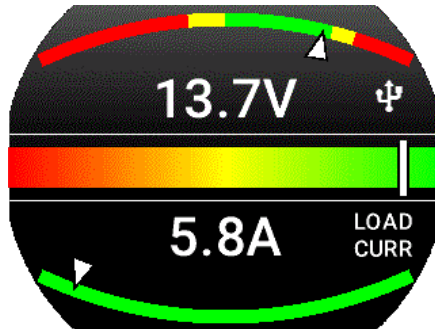

NOTE: It is normal that with the engine off, the indication of the status bar gives alarm indications, in fact in this condition the battery voltage is lower and the battery itself is supplying the energy required by the loads on. In a normal situation, as soon as the engine is started and the generator is enabled, the alarms disappear.

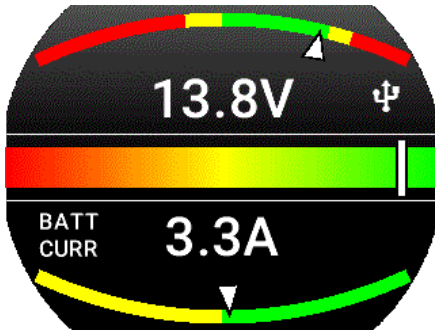

In the picture on the left the health status is green (OK), in fact the voltage is at 13.8V and the battery is charging.

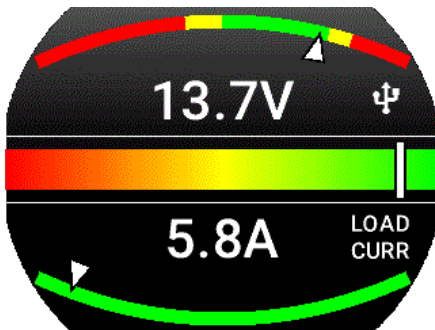

In the picture on the left the health status is green (OK), in fact the voltage is at 13.8V and the loads are absorbing 5.8A.

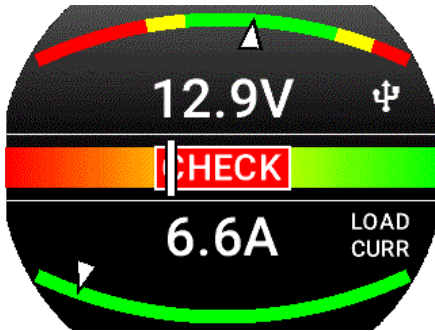

In the picture on the left the health status is yellow, the label CHECK is flashing because the voltage is dropped to 12.9V indicating a possible

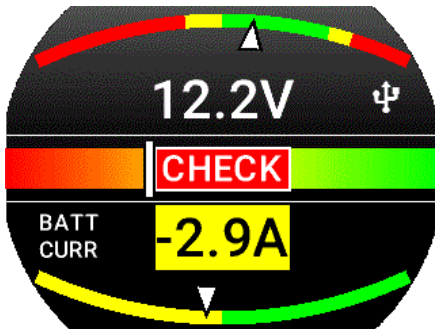

In the picture on the left the health status is yellow, the CHECK label flashes because the voltage has dropped to 12.2V and it is only the battery that supplies current to the loads.

A probable cause is that the on-board generator no longer works and in this way the battery is destined to discharge completely in a time that may depend on various factors such as the number of loads on, the age of the battery, its capacity and its life condition.

5.4 Logger

The Logger can be useful for storing flight data on the USB stick, for example to ask for assistance in case of problems.

The data will be stored at 1 second samples and written on a file with some information of the instrument that generated them.

When the USB flash drive is plugged-in to the device to be logged or to any other instrument of the Omnia57 series installed and clustered via the CAN bus, a white icon will appear on the display indicating that the flash drive is connected.

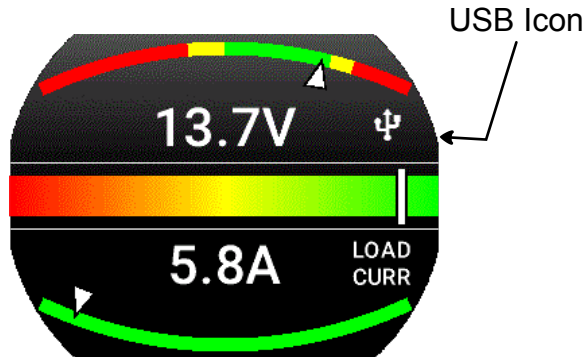

To activate the Logger choose “Yes” from the Main Menu>Logger. The icon will turn **green** when the file is being written and **red** when the Logger is enabled but the USB stick is not connected.

TECHNICAL SPECIFICATIONS

- Graphic TFT LCD with backlight and coated glass, dimensions 29x18mm.
- Standard mounting 2 1/4" (57mm).
- Powder painted aluminium case.
- Dimensions: 60 x 60 x 40 mm.
- Weight: 140g.
- 3 analog input, one for voltage sensing and two for Flybox current sensors.
- Supply voltage: 10 ~ 30 V=.
- Supply current: 60mA.
- Open-collector alarm output (max 300mA, active low). This output can also be used to send a tone in the intercom, using the Flybox optional device code 105899.
- Operating temperature range: -20 ~ +70°C.
- Humidity: 90% max (without condensation).
- Communication through 2 CAN bus.
- USB port: for USB 2.0

CLEANING

The screen is very sensitive to some cleaning materials and should be cleaned with a clean, damp cloth only.

One Year Warranty:

Product support and warranty information can be found at www.flyboxavionics.it.

Flybox® warrants this Product to be free from defects in materials and workmanship for 12 months from date of delivery. The inactivity of the Products determined by periods of repair does not involve the extension of the warranty period.

This warranty covers only defects in material and workmanship found in the products under normal use and service when the product has been properly installed and maintained. This warranty does not cover failures due to abuse, misuse, accident, improper maintenance, failures to follow improper instructions or due to unauthorized alterations or repairs or use with equipments with which the Products is not intended to be used. Flybox®, after verification of the complaint and confirmation that the defect is covered by warranty, at its sole discretion, will either replace or repair the Products at no costs for the customer. Alterations, additions, or repairs not performed by the manufacturer shall negate any warranty. This warranty doesn't cover cosmetic or incidental damages. Shipping costs, taxes, custom fee, any other duties and any costs incurred while removing, reinstalling or troubleshooting the Products, shall be at customer's charge.

TO THE EXTENT PERMITTED BY LAW, THE WARRANTIES AND REMEDIES CONTAINED HEREIN ARE EXCLUSIVE AND IN LIEU OF ALL OTHER WARRANTIES EXPRESS, IMPLIED, OR STATUTORY, INCLUDING ANY LIABILITY ARISING UNDER ANY WARRANTY OF MERCHANTABILITY OR FITNESS FOR A PARTICULAR PURPOSE, STATUTORY OR OTHERWISE. THIS WARRANTY GIVES YOU SPECIFIC LEGAL RIGHTS, WHICH MAY VARY BASED ON YOUR JURISDICTION.

TO THE EXTENT PERMITTED BY LAW, IN NO EVENT SHALL UPRIGHT BE LIABLE FOR ANY INCIDENTAL, SPECIAL, INDIRECT, OR CONSEQUENTIAL DAMAGES, WHETHER RESULTING FROM THE USE, MISUSE, OR INABILITY TO USE THIS PRODUCT. SOME JURISDICTIONS DO NOT ALLOW THE EXCLUSION OF INCIDENTAL OR CONSEQUENTIAL DAMAGES, SO THE ABOVE LIMITATIONS MAY NOT APPLY TO YOU.

Out of warranty repairs

Products that can not be repaired under warranty as out of the maximum term or that do not work for reasons that would have been covered by warranty, can be repaired at a flat rate as described on the site. For out-of-warranty eligible damages, the repair must be assessed for each individual case.

Omnia57 VOLT-AMP - Installation and User Manual,
Safety Instructions and Warning Booklet

Term of Use and Disclaimer

Limitation of Liability

In no event shall MICROEL s.r.l. be liable for any direct, indirect, punitive, incidental, special consequential damages whatsoever arising out of or connected with the use or misuse of its products.

Entire Obligation

The TERM OF USE, WARRANTY AND DISCLAIMER document states the entire obligation of MICROEL S.r.l. with respect to the products. If any part of this disclaimer is determined to be void, invalid, unenforceable or illegal, including, but not limited to the warranty disclaimers and liability disclaimers and liability limitations set forth above, then the invalid or unenforceable provision will be deemed superseded by a valid, enforceable provision that most closely matches the intent of the original provision and the remainder of the agreement shall remain in full force and effect.

General

This disclaimer statement is governed by the laws of ITALY. You hereby consent to the exclusive jurisdiction and venue of the Courts of competent jurisdiction, ITALY, in all disputes arising out of or relating to the use of this product. Use of this product is unauthorized in any jurisdiction that does not give effect to all provisions of these terms and conditions, including without limitation this paragraph.

Date	Revision	Description
02/2019	1.0	First release

Flybox® reserves the right to change the terms, conditions, and notices under which their products are offered without prior notice”.

WARNING: All photos, data, drawings, instruments layouts, technical solutions and data representation you find in this document or watching at FLYBOX® instruments working and/or you can access by means of any other media, including web sites, are sole property of MICROEL s.r.l., cannot be copied or imitate without a written permission of MICROEL s.r.l. itself and are protected by law, even by means of extended international copyright and/or specific patents deposited. Any infringement of this statement and of MICROEL s.r.l. intellectual property will be prosecuted.

©2019 Microel s.r.l. – all rights reserved.

Flybox® is a registered brand of Microel s.r.l.- Italy
www.flyboxavionics.it

MICROEL s.r.l.
Via Mortara 192-194
27038 Robbio (PV) - ITALY
Tel +39-0384-670602 - Fax +39-0384-671830