

SPDC-1570-5-PG

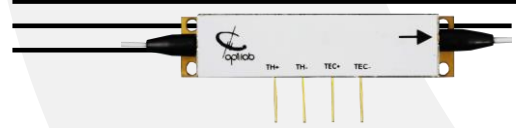

1570 nm type-II SPDC, Device

OVERVIEW

SPDC-1570-5-PG is a packaged 5mm length Periodically Poled Lithium Niobate (PPLN) waveguide chip designed to operate at 1570 nm. This device may be used for Spontaneous Parametric Down-Conversion (SPDC) to create a pair of polarization correlated photon-pairs for Quantum Light Source (QLS) applications. Due to its well confined waveguide structure in Z-cut Lithium Niobate, the SPDC-1570-5-PG allows high power density to enhance the frequency conversion efficiency at wavelengths around 1570 nm when pumped by a 785 nm laser. The spectrum may be tuned by either slightly tuning the pump laser wavelength or by adjusting the temperature of the SPDC-1570-5-PG. Additional operating wavelengths with for Type-II SPDC may be ordered by contacting Optilab directly.

FEATURES

- Designed for Type-II SPDC
- Spatially Uniformed PPLN
- PM Fiber Pigtailed In/Out
- Polarization-Correlated Photon Pairs
- Built-in TEC & Heat Sink
- Titanium In-diffused Waveguide
- High Brightness
- Optimized for Conversion Efficiency & Loss

APPLICATIONS

- Quantum Photon Pair Generation
- Heralded Single Photon Source (HSPS)
- Fiber Based Quantum Optics
- Quantum Light Source (QLS)
- Quantum Key Distribution (QKD)
- EPR Photon Source

FUNCTION DIAGRAM

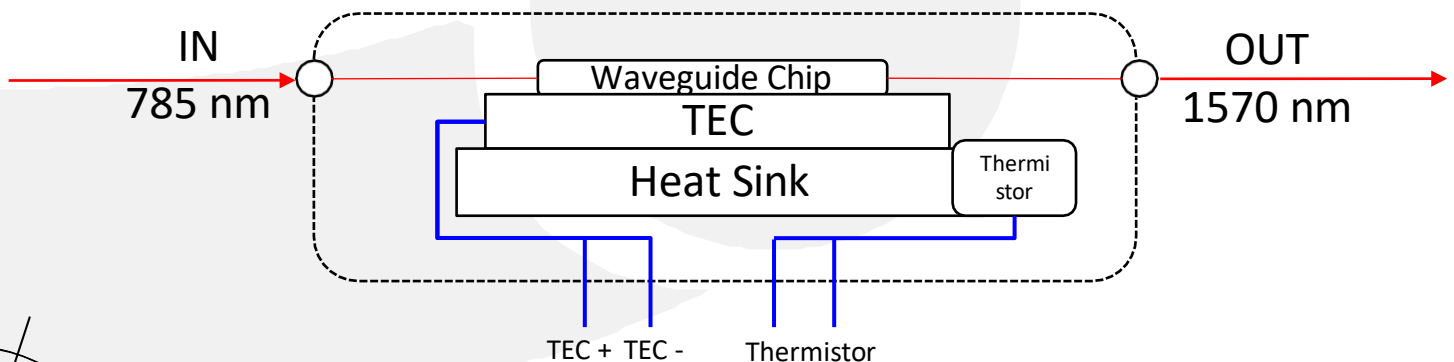

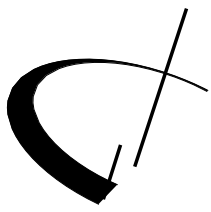

SPDC-1570-5-PG

SPECIFICATIONS

GENERAL

Substrate	Z-cut, X-propagation PPLN
Waveguide	Titanium In-diffusion
Pump Power @ CW	≤ 30 mW
Avg. pump Power @ pulsed pump*	≤ 50 mW
Degeneracy Bandwidth @ 1570nm FWHM	2.5 nm
Insertion Loss	≤ 2.5 dB (2.0 dB typical) @ 1570 nm
Input Fiber Type	PM850
Output Fiber Type	PM1550
In/Output Connector Type	FC/APC
Dimension	50 mm (L) x 18 mm (W) x 7.10 mm (H)
Operating Temperature	10 °C ~ + 60 °C
Storage Temperature	-20 °C ~ + 80 °C
TEC	
Resistance	10 kΩ @ 25 °C
Beta Value	825/85 - 3976 K
Operating Temperature Range	-40 °C ~ + 125 °C
Temperature Accuracy	± .1 from 0 - 70 °C

* Tested by femto-second laser under 76MHz repetition rate with pulse width of 600 fs.

SPDC

SPDC Operation	Type-II
Pump Wavelength	785 ± 1.5 nm
SPDC Degeneracy Wavelength	1570 ± 3 nm
SPDC Polarization	Cross Polarized
Photon-pair Generation Rate*	> 5 x 10 ⁶ Hz/mW
Brightness**	> 10 ⁶ Hz/mW/nm
SPDC Degeneracy Bandwidth	5.0 nm (typical) under CW pump
Temperature Tuning Coefficient	- 0.2 nm/°C

* Based on waveguide pump fundamental mode power = 1mW.

**According to the SPDC degeneracy bandwidth.



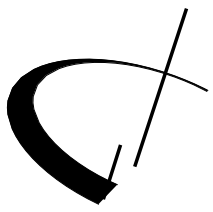

SPDC-1570-5-PG

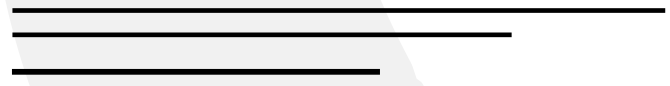

TEST DATA

SPDC WAVELENGTH

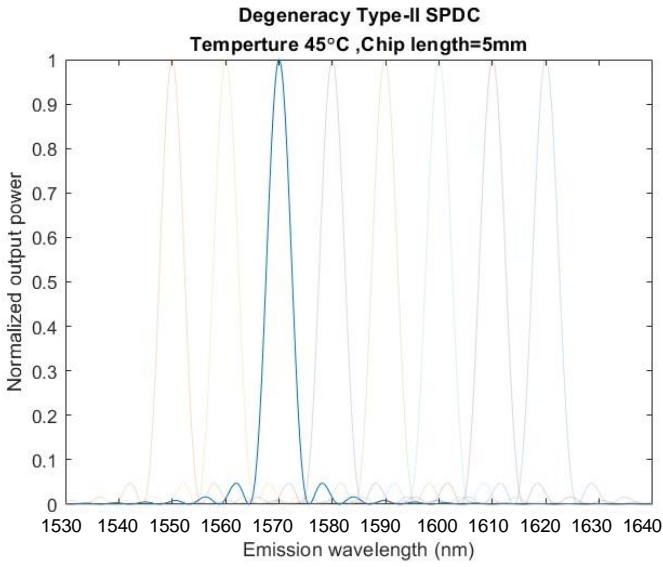

SPDC SPECTRUM

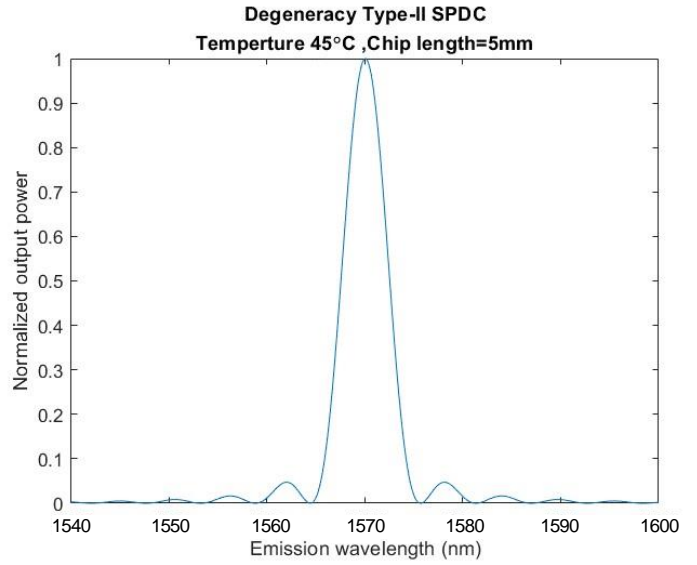

ORDERING OPTION

SPDC-XXXX-5-M

Wavelength (nm)

XXXX: 1530 1540 1550 1560
1570 1580 1590 1600

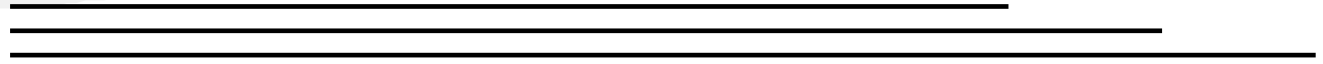

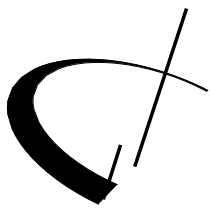

SPDC-1570-5-PG

MECHANICAL DRAWING

PINOUT	
PIN NO.	DESCRIPTION
1	THERMISTOR
2	THERMISTOR
3	TEC-
4	TEC+

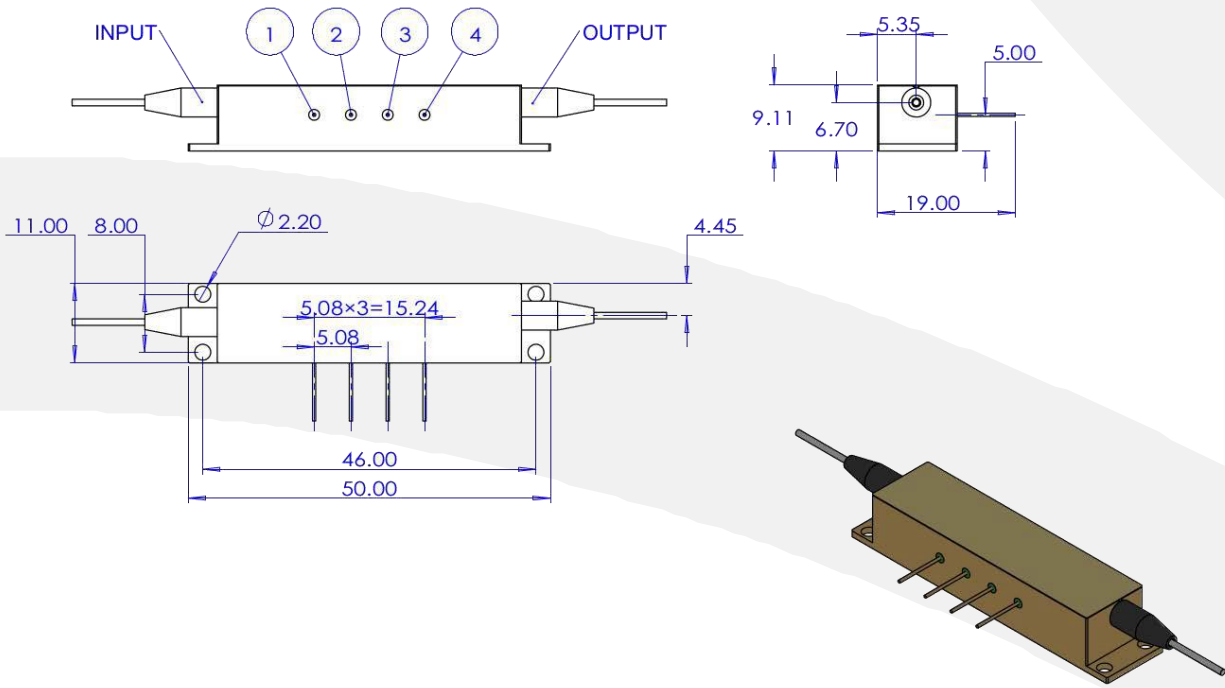

APPLICATION DIAGRAM EXAMPLE

Spontaneous Parametric Down-Conversion Typical Schematic Diagram

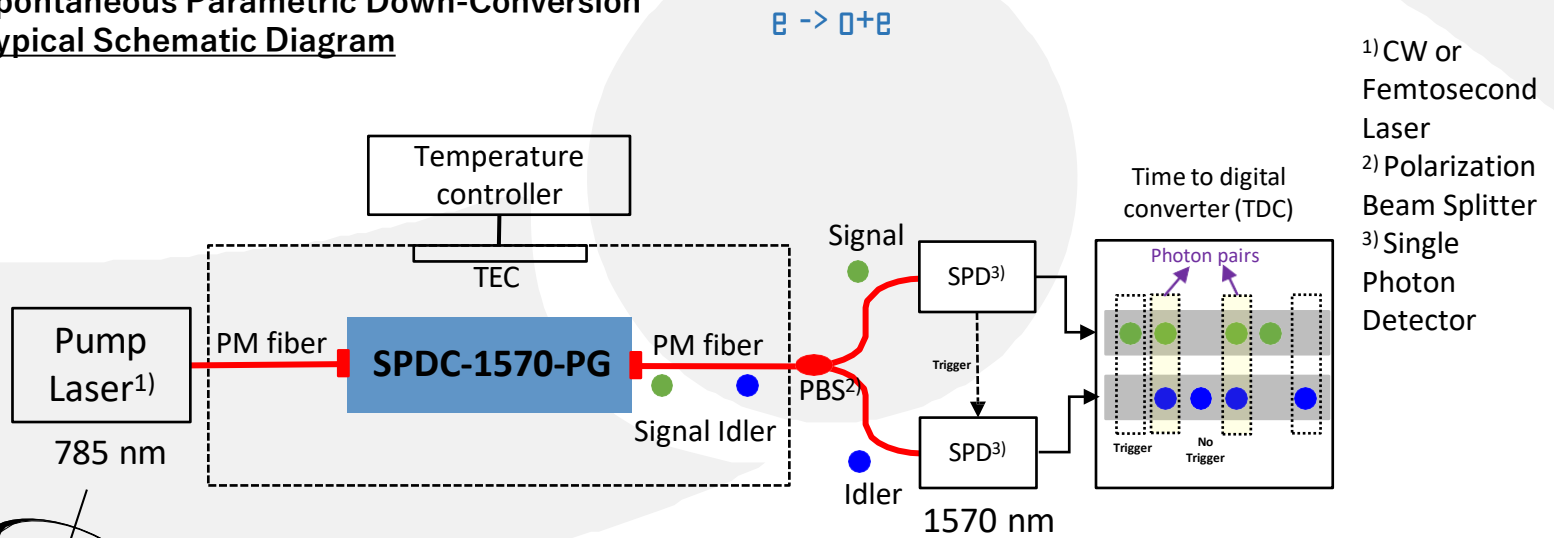

- 1) CW or Femtosecond Laser
- 2) Polarization Beam Splitter
- 3) Single Photon Detector



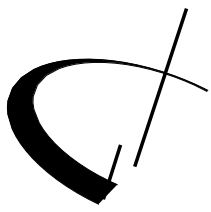

SPDC-1570-5-PG

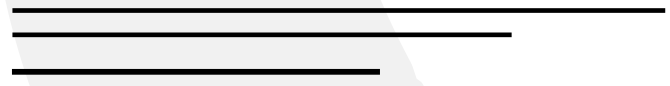

RELATED PRODUCTS

- SPDC-1570-5-BC



SPDC-1570-5-BC is a 5mm length Periodically Poled Lithium Niobate (PPLN) waveguide chip designed to operate at 1570 nm. Contact Optilab for more information

- PT-5000-MC



PT-5000-MC is a fully integrated Precision Temperature Controller designed for Optilab's SPDC / SFG 4 pins waveguide modules. Contact Optilab for more information.

