

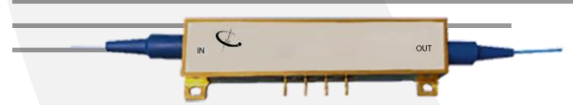

SFG-775-5-PG



Sum Frequency Generator Module for 775 nm

OVERVIEW

SFG-775-5-PG is a 5 mm Periodically Poled Lithium Niobate (PPLN) waveguide modules for near-IR, and mid-IR light generation. The module has a PPLN waveguide with built-in TEC and a Heatsink. A custom design of the poling period is available. This module may be pumped in 1550 nm wavelength window for up-conversion of photons to the 775 nm region. Due to the large nonlinear optical coefficient and the well confined optical waveguide structure in the Z-cut Lithium Niobate, the SFG-775-5-PG allows high up-conversion efficiency. The spectrum of the output may be tuned by either slightly tuning the pump laser wavelength or by adjusting the temperature of the SFG-775-5-PG. Please specify your pump and SHG/SFG/DFG wavelengths down to 775 nm when ordering modules.

FEATURES

- SFG/SHG/DFG
- Built-in TEC, Thermistor, Heatsink
- Spatially Uniformed PPLN
- PM Fiber Pigtailed In/Out
- Titanium In-diffused Waveguide
- High Conversion Efficiency
- Phase Matching

APPLICATIONS

- Quantum Light Source (QLS)
- Mid-IR Source
- SFG Spectroscopy
- Frequency Doubling
- Wavelength Conversion

FUNCTION DIAGRAM

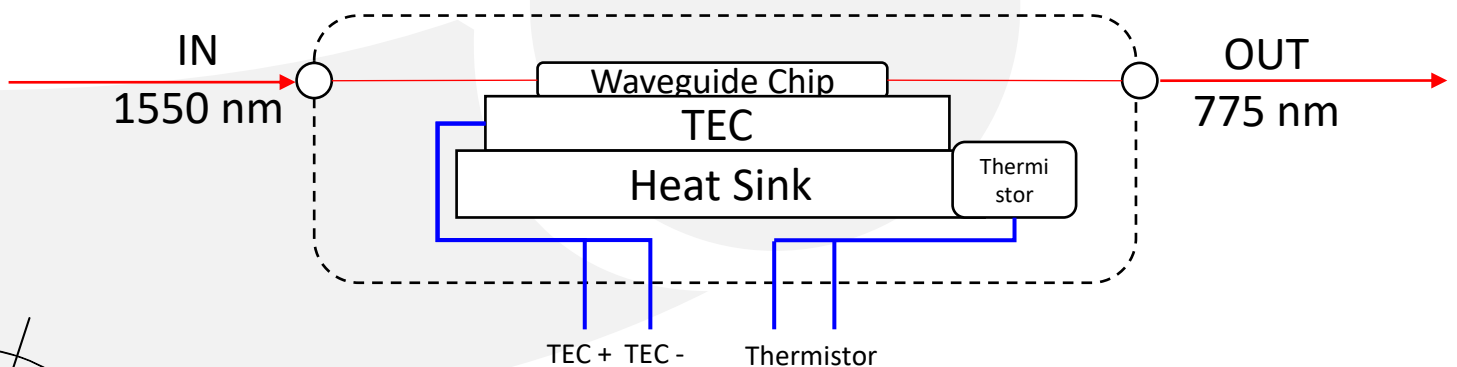

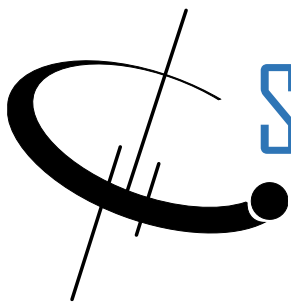

SFG-775-5-PG

SPECIFICATIONS

GENERAL

Substrate	Z-cut, X-propagation PPLN
Waveguide	Titanium In-diffusion
Pump Power Threshold @ CW	≤ 30 mW
Avg. pump Power @ pulsed pump*	≤ 50 mW
Degeneracy Bandwidth @ 1550nm FWHM	1.25 nm
Insertion Loss	≤ 2.5 dB (2.0 dB typical) @ 1550 nm
Input Fiber Type	PM1550
Output Fiber Type	PM85
In/Output Connector Type	FC/APC
Chip Dimension	5 mm (L) x 2 mm (W) x 1 mm (H)
Operating Temperature	10 °C ~ + 65 °C
Storage Temperature	-20 °C ~ + 80 °C

* Tested by femto-second laser under 76MHz repetition rate with pulse width of 600 fs.

TEC

Temperature Controller	Thermo Electric Type
TEC Current	2.5 A max.
Thermistor Resistance	10 kΩ @ 25 °C
β Value	825/85 - 3976 K
Operating Temperature Range	10 °C ~ 75 °C
Temperature Accuracy (w/Optilab TEC)	± 0.1 °C
Housing Material	Stainless Steel

SFG & SHG

SFG/SHG Operation	Type-II
Pump Wavelength	1550 ± 5 nm
SFG/SHG Wavelength	775 ± 2.5 nm
SFG/SHG Efficiency	> 30%
Temperature Tuning Coefficient	-0.2 nm/°C



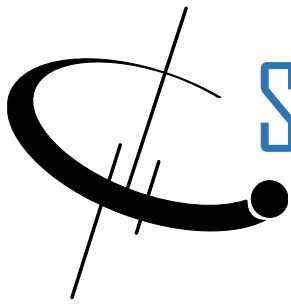

SFG-775-5-PG

TEST DATA

Temperature Tuning of SFG-775

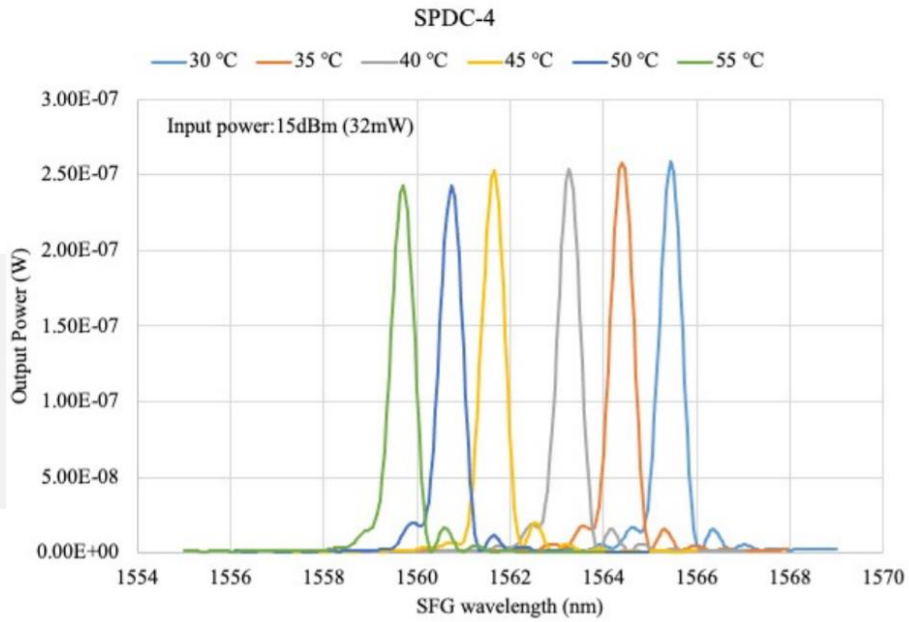

ORDERING OPTION

SFG-XXXX-5-M

Wavelength (nm)

XXXX: 765 770 775 780
785 795 800



SFG-775-5-PG

MECHANICAL DRAWING

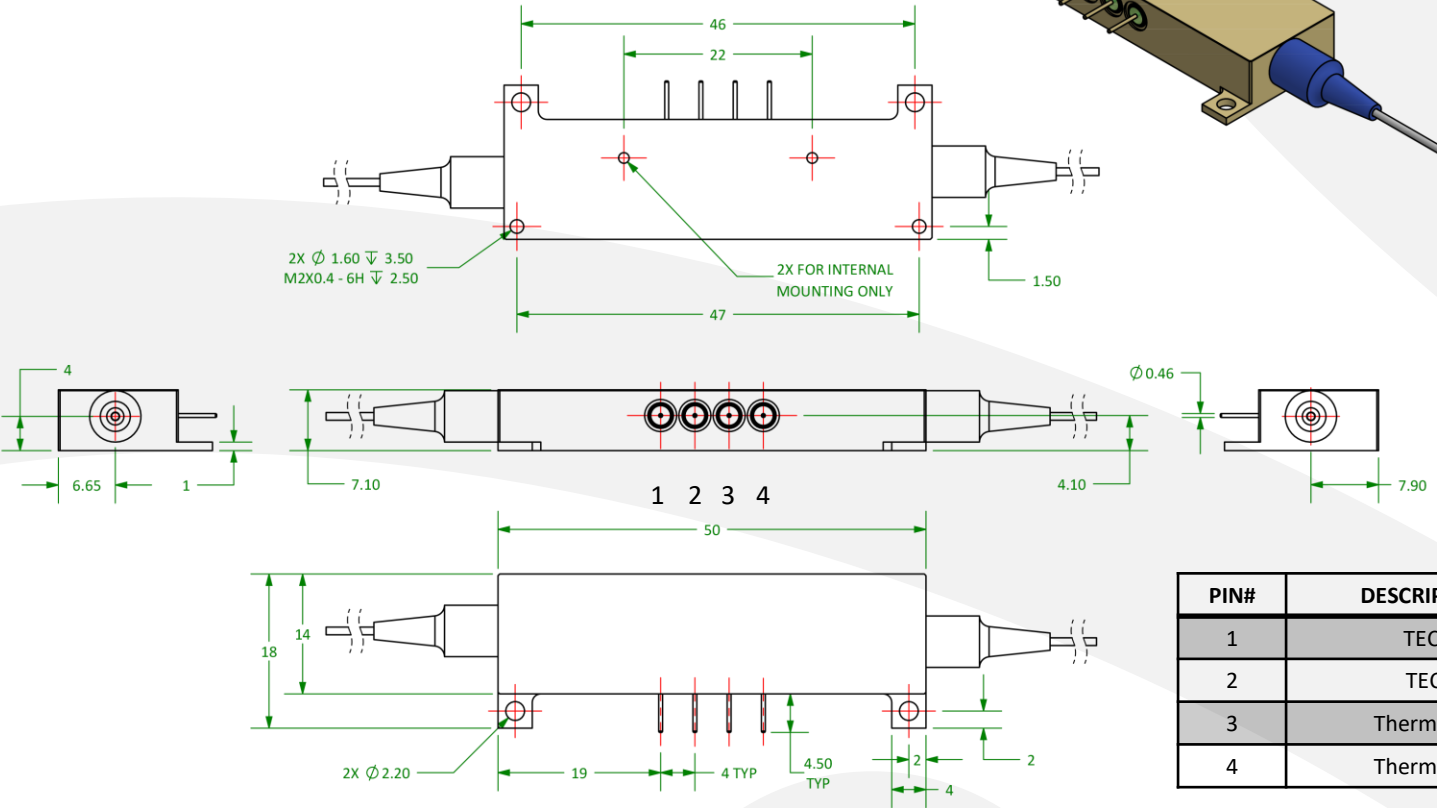
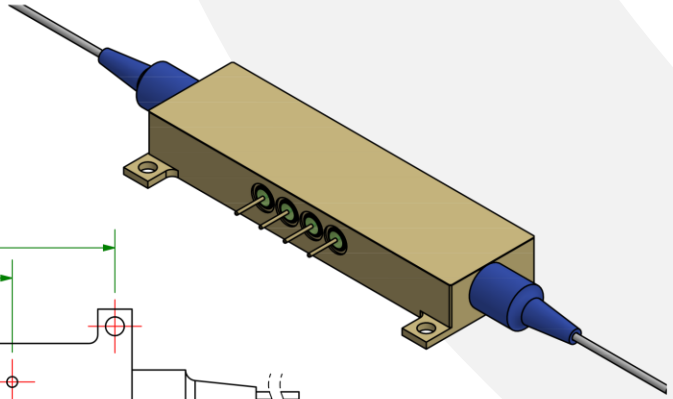

PIN#	DESCRIPTION
1	TEC+
2	TEC-
3	Thermistor
4	Thermistor

APPLICATION DIAGRAM

Sum Frequency Generator (Or SHG) Module Evaluation Setup Example

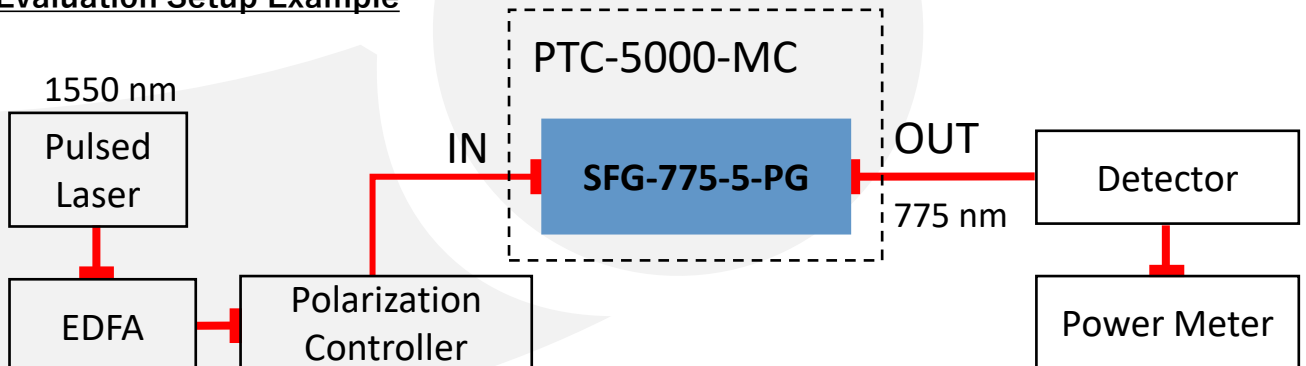

SFG-775-5-PG

RELATED PRODUCTS

- PT-5000-MC



PT-5000-MC is a fully integrated Precision Temperature Controller designed for Optilab's SPDC / SFG 4 pins waveguide modules. Contact Optilab for more information.

- SPDC-15XX-YY-M



SPDC-15XX-YY-M is a Periodically Poled Lithium Niobate (PPLN) waveguide module designed to operate at 15XX nm. Contact Optilab for more information

- FML-15-B



The Optilab FML-15-B Femtosecond Mode-Locked Laser (FML) Benchtop utilizes a proprietary Saturable Absorber (SA) for passive mode locking, It also can be used for SFG pulse source. Contact Optilab for more information

- PPL-1550-R



The Optilab PPL-1550-R is a programmable laser that produces picosecond pulses with electrical input pulses, It also can be used for SFG pulse source. Contact Optilab for more information

- NPL-37-B



The Optilab NPL-1550-37-R is a versatile high-power pulsed laser that is designed for research and development of pulse systems, It also can be used for SFG pulse source. Contact Optilab for more information

