

LTA-20

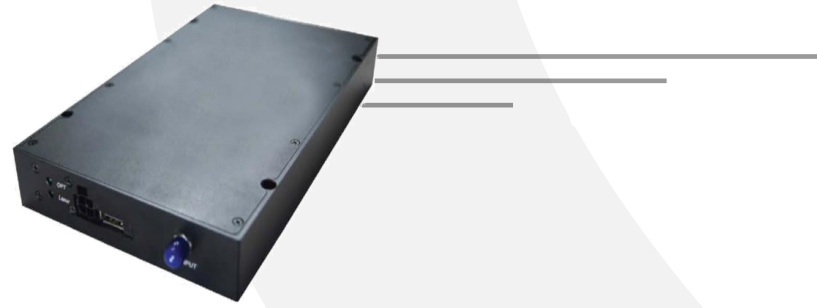

DEVICE

20 GHz Lightwave Transmitter Modulator for RFoF

OVERVIEW

The Optilab LTA-20 is a high performance Lightwave Transmitter Modulator designed for analog photonics applications from DC to 20 GHz. This unit includes a 18 GHz optical intensity modulator and an Automatic Bias Control (ABC) board with four different operating modes. The integrated internal DFB laser makes it a versatile solution for RFoF system integration. The LTA-20 requires a single ± 5 Volt DC power supply for operation. Contact Optilab for more information.

FEATURES

- 14 GHz S21 bandwidth modulator
- 1520 nm to 1610 nm wavelength range
- Automatic Bias Control w/ 4 mode operation
- Internal DFB laser up to 50 mW
- Customizable Options:
 - Low Drive Voltage
 - PM output
 - High Extinction Ratio (> 30 dB)

USE IN

- Sub-nanosecond pulse generation
- Optical communications to 25 Gb/s
- 20 GHz RFoF transmission
- Analog photonics
- RF/IF signal distribution
- Satellite communication

FUNCTIONAL DIAGRAM

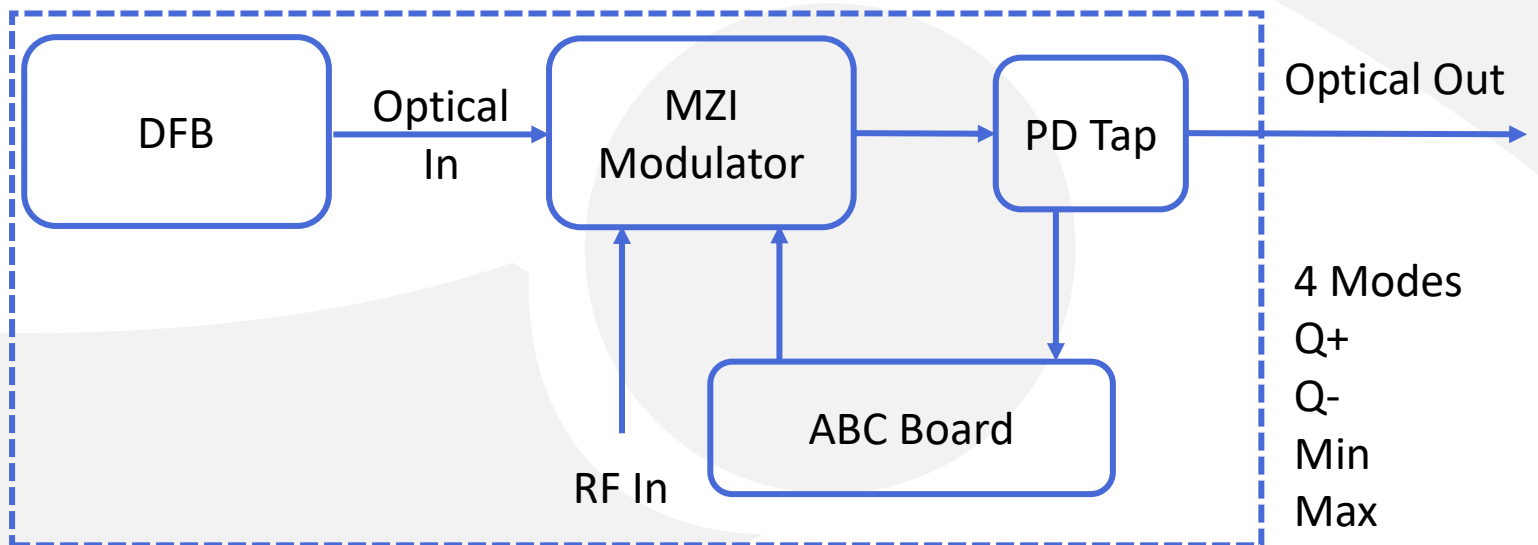

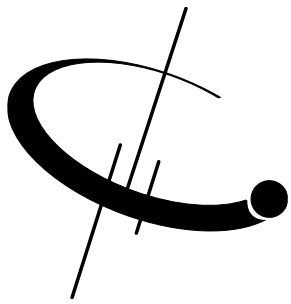

LTA-20

SPECIFICATIONS

Operating Wavelength	1520 nm to 1610 nm
Laser Source	Internal DFB laser, 1550 ± 10 nm; other wavelengths and narrow linewidth < 1 MHz are available
Laser Power Level	20, 30, 40, 50 mW
RF Return Loss	> 15 dB @ 10 GHz; > 10 dB @ 20 GHz
Impedance	50Ω
Operating Frequency Range	DC to 25 GHz
Input RF Voltage	27 dBm max.
Optical Output Level	6.5 dBm typ. With 20 mW DFB
S21 Bandwidth	3 dB, 14 GHz typ.
Modulator Bias Mode	4 Automatic bias control modes, selectable by software
Extinction Ratio	25 dB typ.; > 30 dB (HE version)
Modulator Voltage V_{PI}	7 V typ. @ 10 GHz; 5.5 V typ. @ 10 GHz (LD version)

GENERAL

ANALOG

IIP3 @ 7 GHz	32 dBm typ.; 29 dBm typ. (LD version)
1 dB Compression Point @ 10 GHz	16.5 dBm typ.; 14.5 dBm typ. (LD version)

MECHANICAL

Operating Temperature (standard)	-30 °C to +60 °C
Storage Temperature	-60 °C to +90 °C
Power Supply Requirements	± 5 V DC, 1 A typ.
Optical Connector	FC/APC
Fiber Type	SMF-28 output; PANDA output (PM version)
RF Input Connector	K connector
Power Connector	4 Pin Molex
Remote Control	USB 2.0 software included
Alarm	LED bias mode status
Dimensions	220 mm x 119 mm x 27 mm

BIAS CONTROL MODE

Mode	Operation Conditions
Q+	Set to quadrature point of positive slope for linear analog modulation
Q-	Set to quadrature point of negative slope for linear analog modulation
Min.	Set to min. point of operation for pulse generation or digital modulation
Max.	Set to max. point of operation for pulse generation or digital modulation



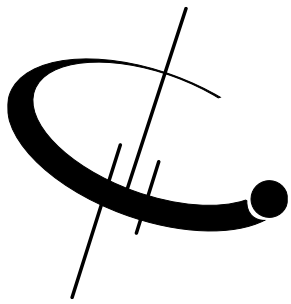

LTA-20

TYPICAL S21 AND S11 BANDWIDTH

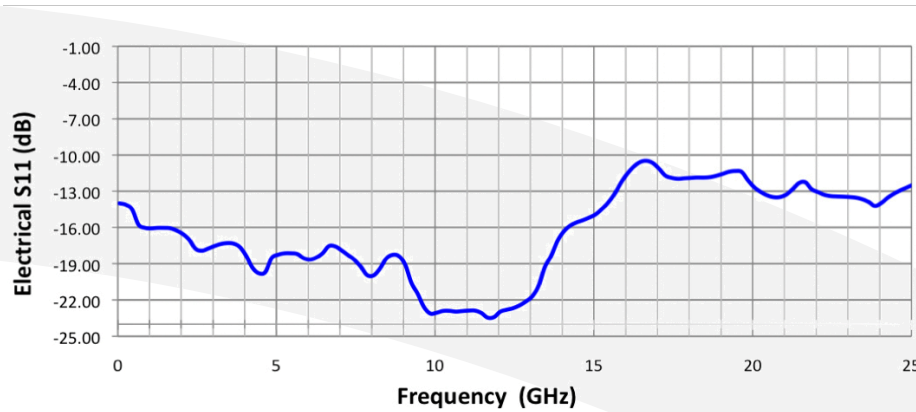
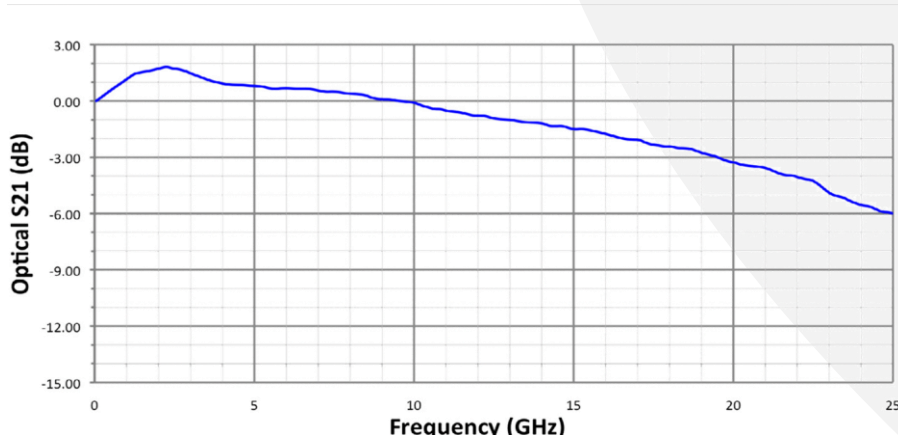

BIAS SETTING MODES FOR LTA

Based on sophisticated phase measurement of this small dither signal, LTA-20 provides four selectable operating modes: quadrature (Quad +), inverted quadrature (Quad -), minimum (Min), or maximum (Max) points.

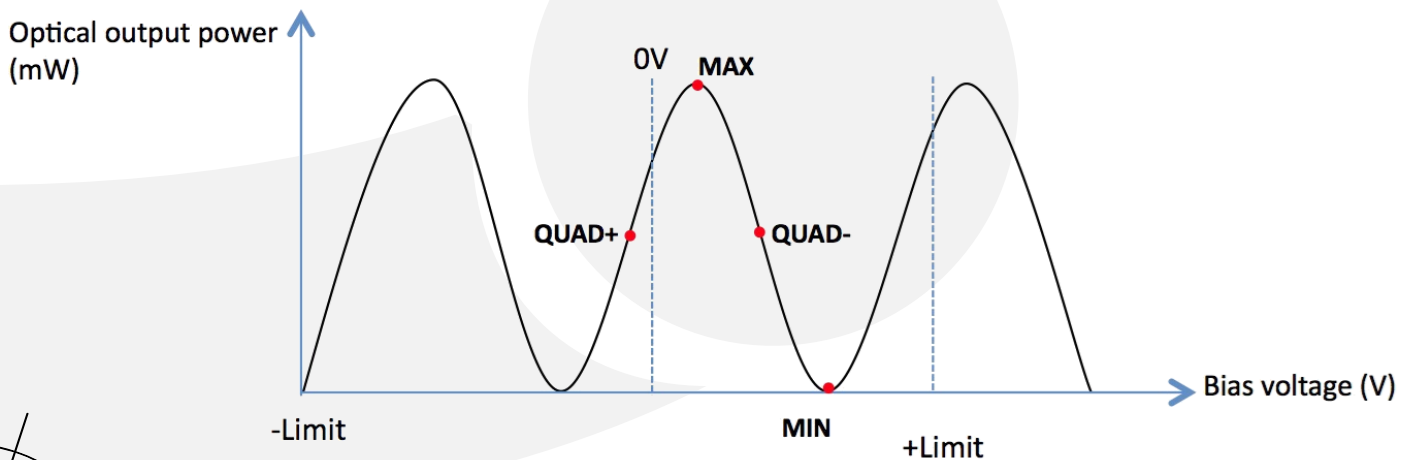

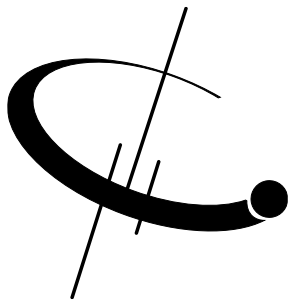

LTA-20

DETAILED LAYOUT



No.	Feature
1	Optical Output Port
2	RF Input Port
3	LED Indicators
4	DC Connection Port
5	USB Control and Monitor Port

MECHANICAL DRAWING

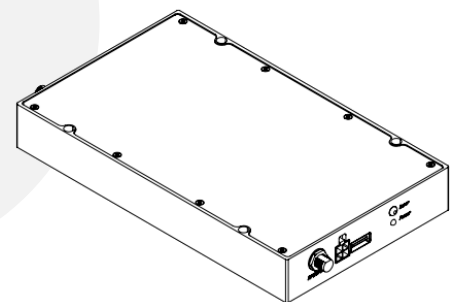
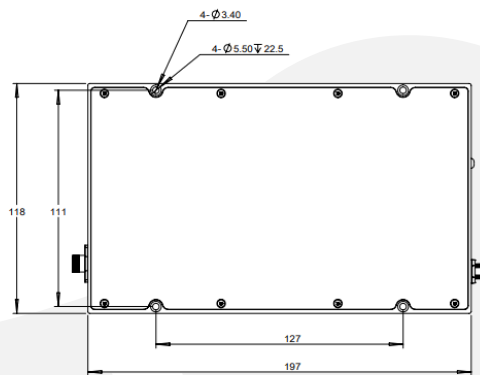
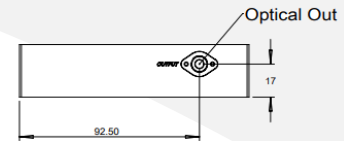
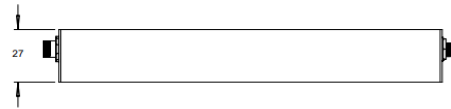
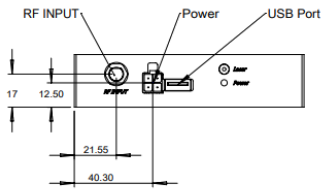

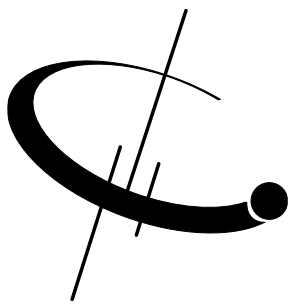

LTA-20

PRECISION POWER SUPPLY FOR LTA (OPTIONAL)

FRONT



BACK



General Specifications	
Parameters	Specifications
Input AC Voltage (VAC)	85-240
Input AC Current (A)	≤0.5
Input AC Frequency (HZ)	50-60
Transfer Efficiency	≤85%
DC Output Current (A)	4 A max.
DC Output Voltage (V)	±5 V
DC Voltage Ripple	≤2%
DC Connectors	Molex 4 Pin
Communication Connectors	DB-9 and USB 2.0
Dimensions (mm)	153x115x33

ORDERING OPTIONS

LTA-20-XX

- LD: Low Drive Voltage
- PM: Polarization Maintaining
- HE: High Extinction Ratio



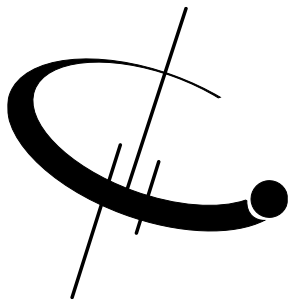

LTA-20

TYPICAL S21 AND S11 BANDWIDTH FOR LD VERSION

