

# DFB-1550-EAM-32

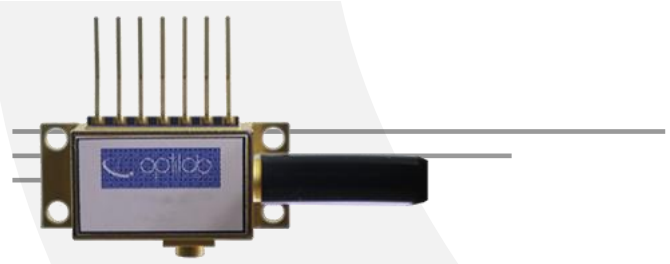

## EML DFB Laser Diode, 32 GHz, 5mW

### OVERVIEW

The Optilab DFB-1550-EAM-32 laser diode is a high performance and compact laser solution for applications. Consisting of a DFB laser with an integrated electro-absorption modulator (EAM), this allows for modulation speeds of over 32 GHz and digital 40 Gb/s applications on one 7-pin butterfly package device. It features a thermoelectric cooler (TEC), temperature thermistor, optical isolator and a GPO RF connector. contact Optilab for more information

### FEATURES

- 1550 nm DFB + EAM Modulator
- Hermetic, 7 pin butterfly package
- Single-mode fiber pigtail
- 32 GHz bandwidth
- 5 mW output power
- TEC Cooler

### APPLICATIONS

- Optical Communication
- RFoF
- Microwave Link
- Pulse Source

### PIN OUT

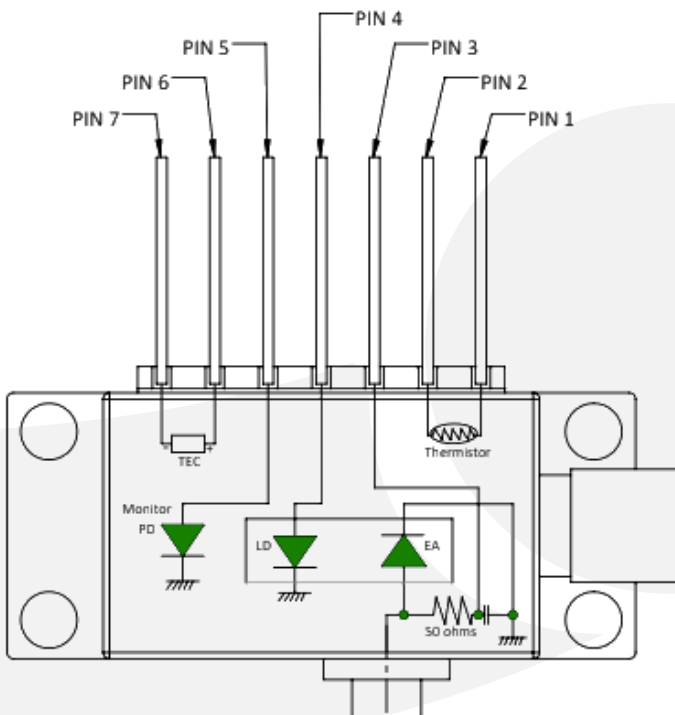

- 1 Thermistor
- 2 Thermistor
- 3 EA Bias
- 4 LD Anode
- 5 PD Anode
- 6 TEC Anode
- 7 TEC Cathode



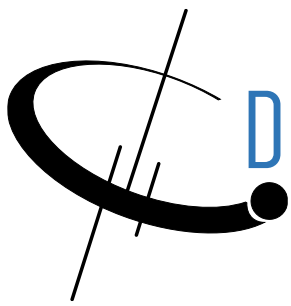

# DFB-1550-EAM-32



## SPECIFICATIONS

### GENERAL

Operating Wavelength Range	1538nm +/-10nm
Output Power	5 dBm min.
Side Mode Suppr. Ratio	40 dB.
Optical Isolation	30 dB min.
Operating Current	100 mA max.
Threshold Current	35 mA max.
Forward Voltage	2 V max.
Bandwidth	32 GHz typ.
Monitor Current	50 uA min.
Thermistor Resistance	3450 K
TEC Voltage	3 V max.
TEC Current	1.2 V max.

\*Vm : DC Bias applied to EA Modulator

### MECHANICAL

Operating Case Temperature	0 °C to +77 °C
Storage Temperature	-40 °C to +85 °C
Optical Connector	FC/APC
Fiber Type	SMF-28
RF Connector	GPPD male

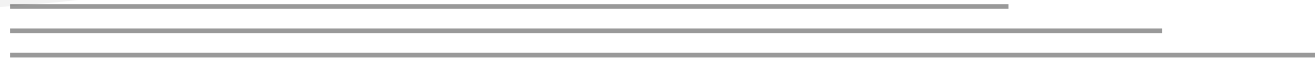

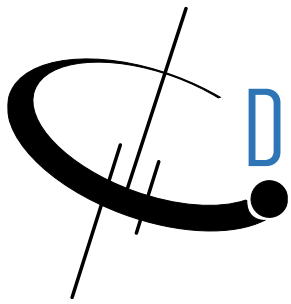

# DFB-1550-EAM-32

## TYPICAL FREQUENCY RESPONSE

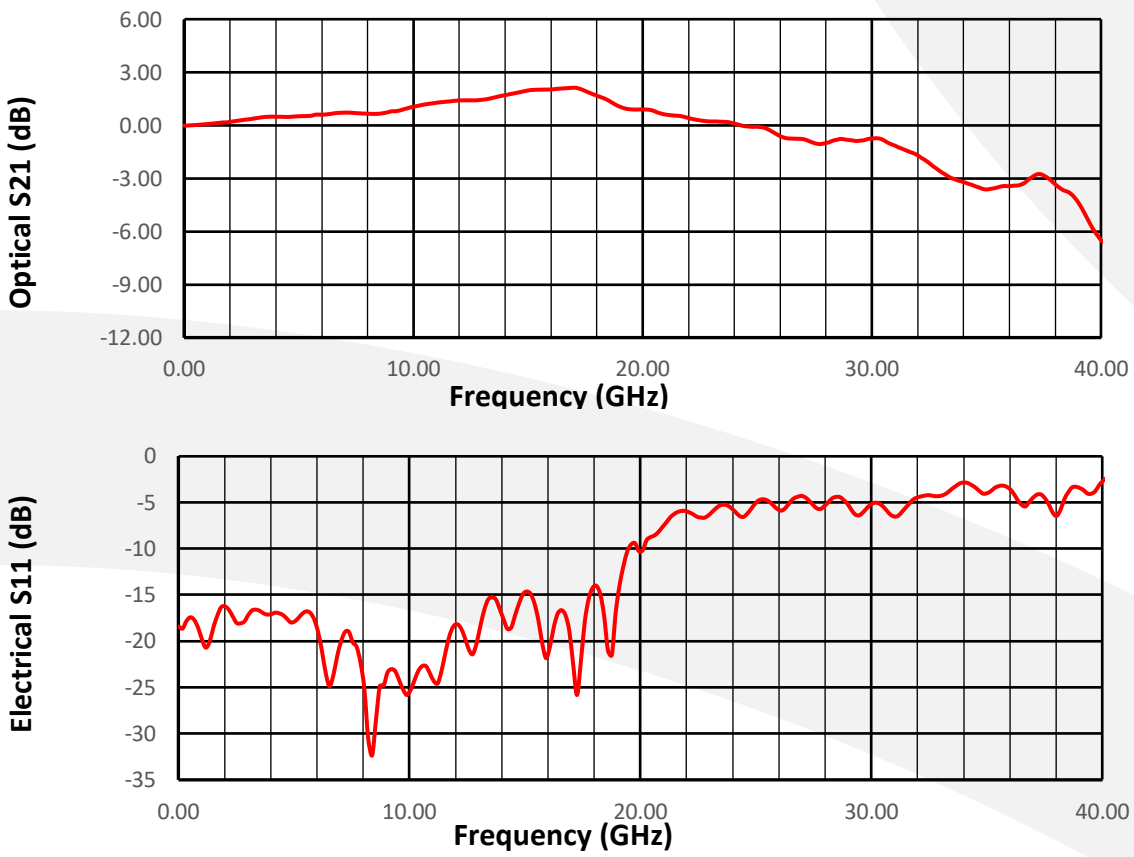

## 40 Gbps NRZ EYE DIAGRAM

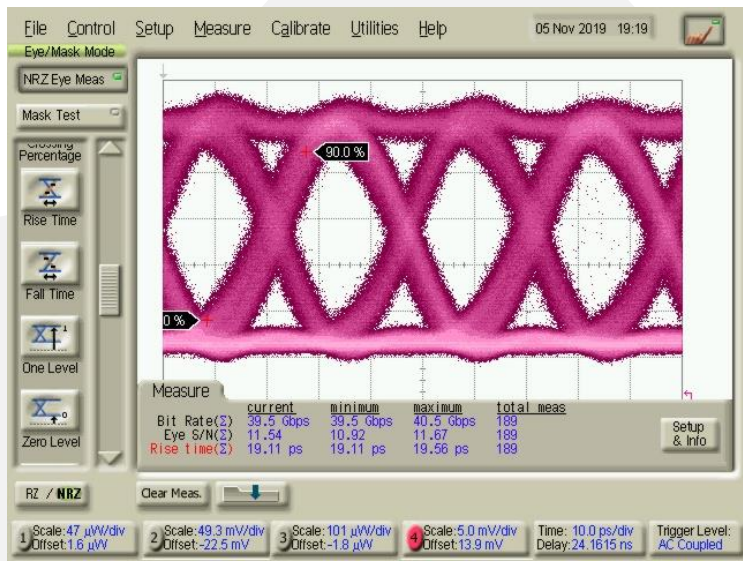

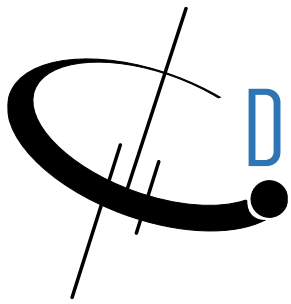

# DFB-1550-EAM-32

## TYPICAL TRANSFER FUNCTION

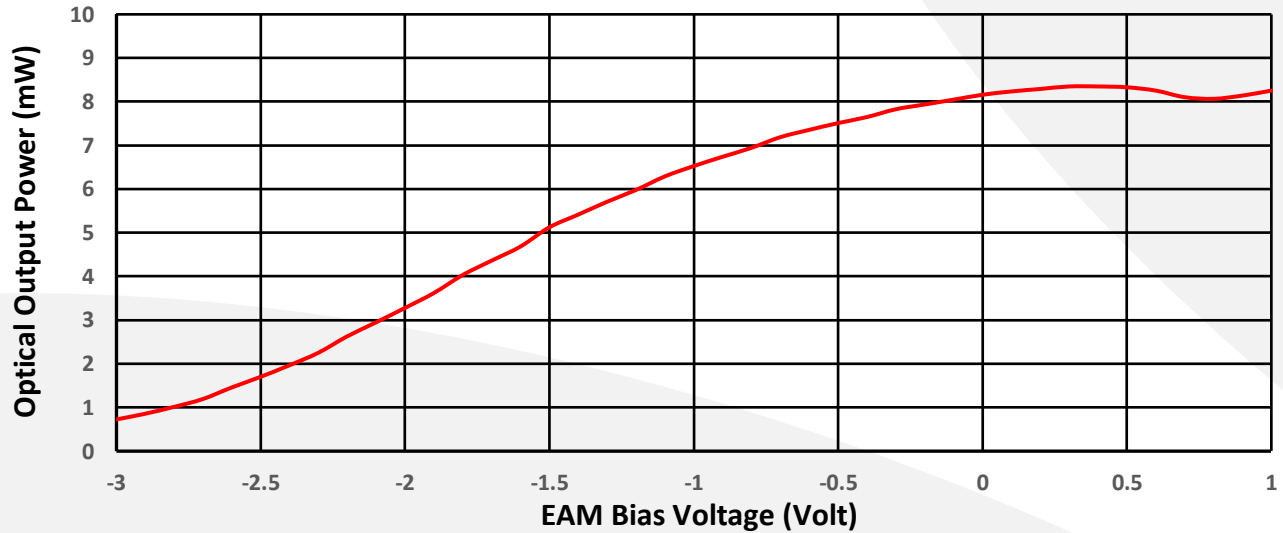

## BIAS SETTING MODES FOR DFB

Based on sophisticated phase measurement of this small dither signal, DFB-1550-EAM-32 provides four selectable operating modes: quadrature (Quad +), inverted quadrature (Quad -), minimum (Min), or maximum (Max) points.

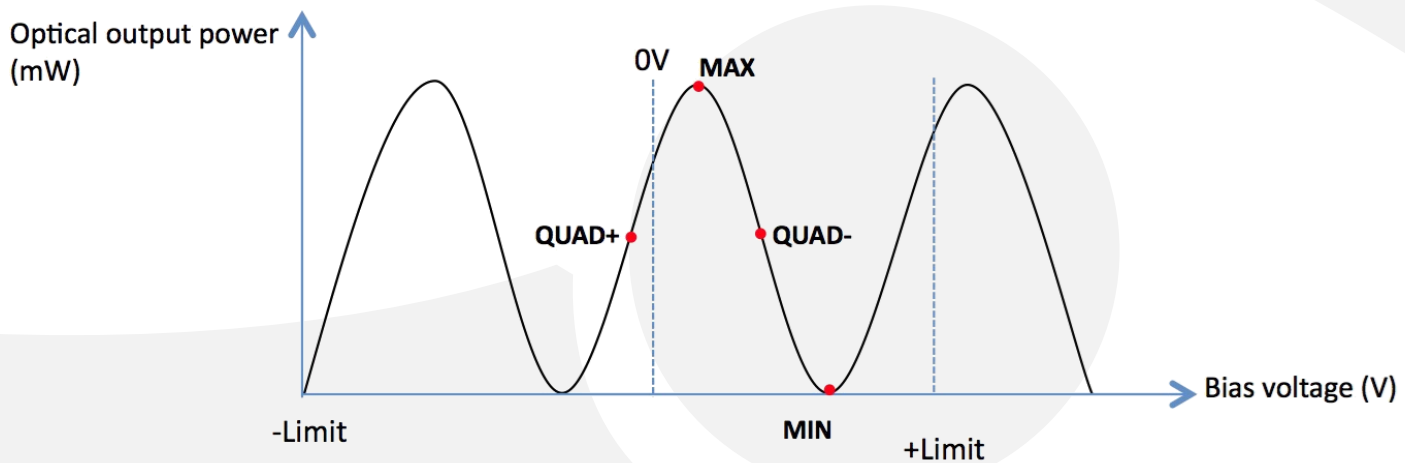

# DFB-1550-EAM-32

## MECHANICAL DRAWING

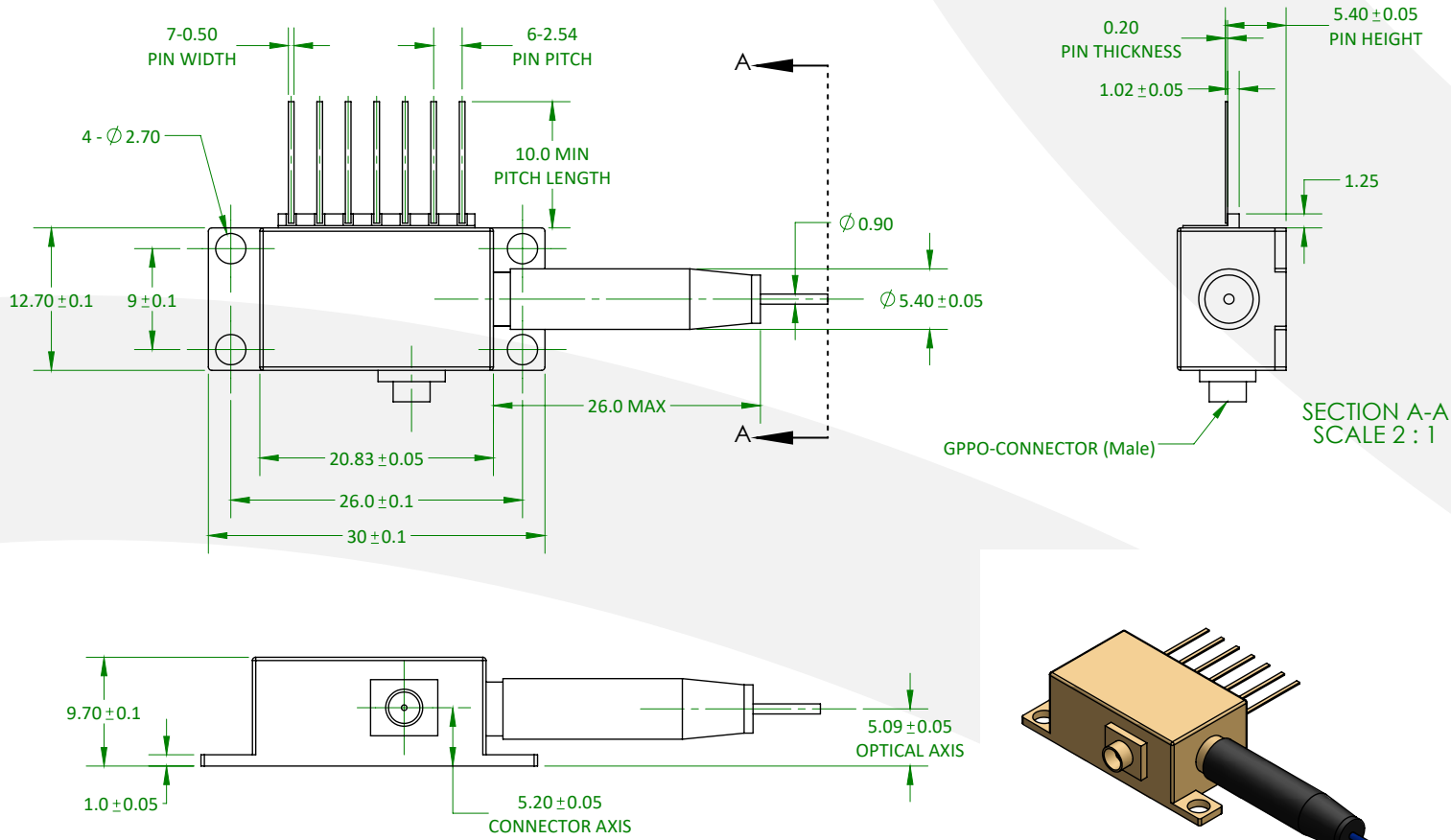

## RELATED ITEMS

- MD-50E-M



The Optilab MD-50E-M Modulator Driver (MD) is a 50 GHz two-stage RF Amplifier in a user-friendly module that provides a high-quality, single-ended voltage to drive an Electro-Absorption(EA) optical modulator. Contact Optilab for more information.

