

BUYDEEM

G553/G563

Multi-function Steaming Cooker

Instruction Manual



BUYDEEM

Shenzhen Buydeem Technology Co, LTD

G553/G563-91-A1

Please refer to the actual product if small changes are made.

Please keep the manual and read it before using the product

Room 3801, Building A, Tanglangcheng West, No.3333
Liuxian Boulevard, Nanshan District, Shenzhen, China.

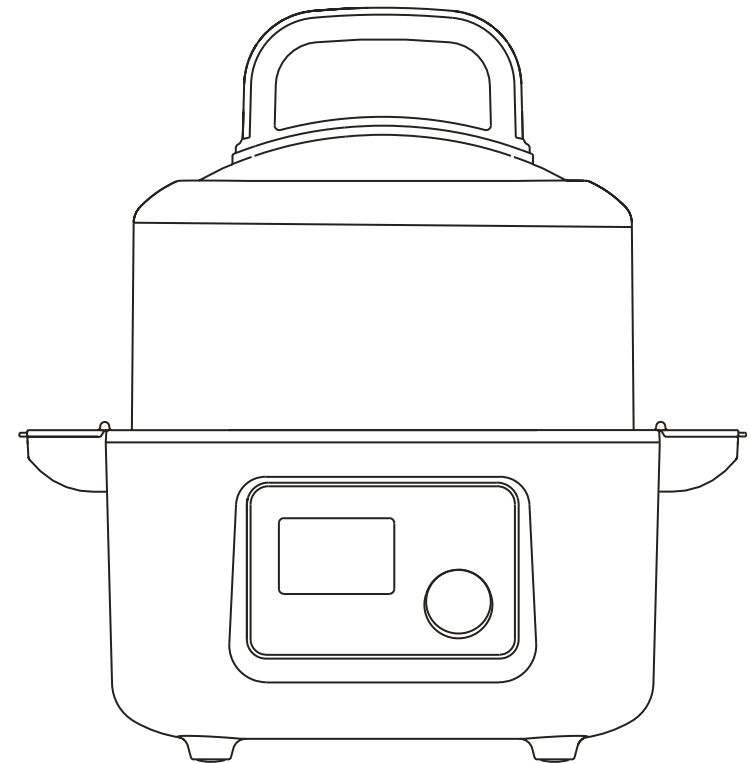

Thank you for choosing Buydeem's product. Please read this manual for your full understanding of the functions of the product.

Contents

Notice	02	Using Product	13-20
Specification	03	First use	13
Understanding Product	04-12	Quick installation	13
Structural Diagram	04	Use instruction	14
Command panel	06	Boiling point	21
Functions & modes	07	Features	23
Components	08	Cleaning and maintaining	24
		Simple troubleshooting	25
		List of Environmental Protection	27
		Warranty & Service	28

Notice

IMPORTANT SAFEGUARDS

When using electrical appliances, basic safety precautions should always be followed including the following:

1. Read all instructions.
2. Do not touch hot surfaces. Use handles or knobs.
3. To protect against electrical shock do not immerse cord, plugs, or product in water or other liquid.
4. Close supervision is necessary when any appliance is used by or near children.
5. Unplug from outlet when not in use and before cleaning. Allow to cool before putting on or taking off parts.
6. Do not operate any appliance with a damaged cord or plug or after the appliance malfunctions or has been damaged in any manner. Return appliance to the nearest authorized service facility for examination, repair, or adjustment.
7. The use of accessory attachments not recommended by the appliance manufacturer may cause injuries.
8. Do not use outdoors .
9. Do not let cord hang over edge of table or counter, or touch hot surfaces.
10. Do not place on or near a hot gas or electric burner, or in a heated oven.
11. Extreme caution must be used when moving an appliance containing hot oil or other hot liquids.
12. Always attach plug to appliance first, then plug cord into the wall outlet. To disconnect, turn any control to "off", then remove plug from wall outlet.
13. Do not use appliance for other than intended use.
14. Intended for countertop use only.
15. WARNING: Spilled food can cause serious burns. Keep appliance and cord away from children. Never drape cord over edge of counter, never use outlet below counter, and never use with an extension cord.

Save these Instructions.

Household Use Only

Danger

- To avoid dangers like electric shock or short circuit, do not place the steamer, power cord and plug in water or any other liquid, and do not rinse it in the tap.

Warning

- Before use, please check whether the voltage displayed on the product specification label is consistent with the main voltage in your area.
- Children, the elderly, persons with limited physical or mental capacity, and persons with no experience in using the product should use the product under supervision and guidance for safety.
- Children should be under supervision when they are in touch with the product. Ensure that they do not play with the product as toys.
- This product must use a grounding socket with a rated current of more than 10A and a rated voltage of 120V~60Hz, 15A. The plug must be fully inserted into the socket to prevent poor contact with plug which may cause overheating and burnout of the component, short circuit or fire.
- Do not use a universal socket.
- Keep the steamer, various accessories of the steamer, and the power cord away from high temperature, open flames, wet, smooth countertops or sharp edges to prevent the damage, malfunction or fire.
- Do not use a steamer when you have water on your hands or bare feet.
- Pay special attention to the risk of burns during use! During operation, the surface of the steamer and its interior (such as the steam rack, the juice tray, etc.) will reach a very high temperature, and it will remain high for a while after the power is turned off. Please wear the thermal insulation equipment before use, and avoid direct contact with hot surfaces to prevent burns.

Notice

Notice

- This product is designed for domestic use only, and the manufacturer only guarantees production defects and domestic malfunctions. The manufacturer will not be held responsible for any commercial use, unsuitable use, or consequences and failures caused by failure to follow the instructions. The product will not be covered by warranty.
- This product must be used with its matching power cord. Do not use other power cords.
- Always place the steamer on a flat, stable, heat-resistant workbench.
- Before using the product, please make sure that the lid is properly closed to prevent the steam from escaping and causing burns.
- Steam stew can generate high temperature and steam during work. Do not touch, lift or move the lid of the steamer in an improper manner during work. Do not approach high temperature areas such as the steam outlet to prevent burns.
- Avoid placing the steamer in the working state near or under furniture that is sensitive to water vapor (such as wooden cabinets, coffee tables, etc.).
- Do not heat the closed container in a steamer to prevent the risk of explosion.
- Do not operate the steamer over the maximum water level or below the minimum water level; if the water tank is overfilled with water, it may cause boiling water to splash out.
- Do not move the steamer or move it above the steamer when the steamer is working, otherwise it may cause malfunction or burns.
- Be careful when removing the lid to avoid scalding the body from the condensation water flowing out of the lid.

A short power-supply cord is used to reduce the risk resulting from it being grabbed by children, becoming entangled in, or tripping over a longer cord.

technical specifications

Product name	Multi-function steaming cooker		Model	G553/G563	
Product power	1500W	Maximum capacity	2.0L	Voltage	120V~60Hz

Food grade material including SUS316L and 304 stainless steel, Polypropylene PP plastic, Silicone for food contact.

Understanding Product

Product structural diagram

Lid and Pot

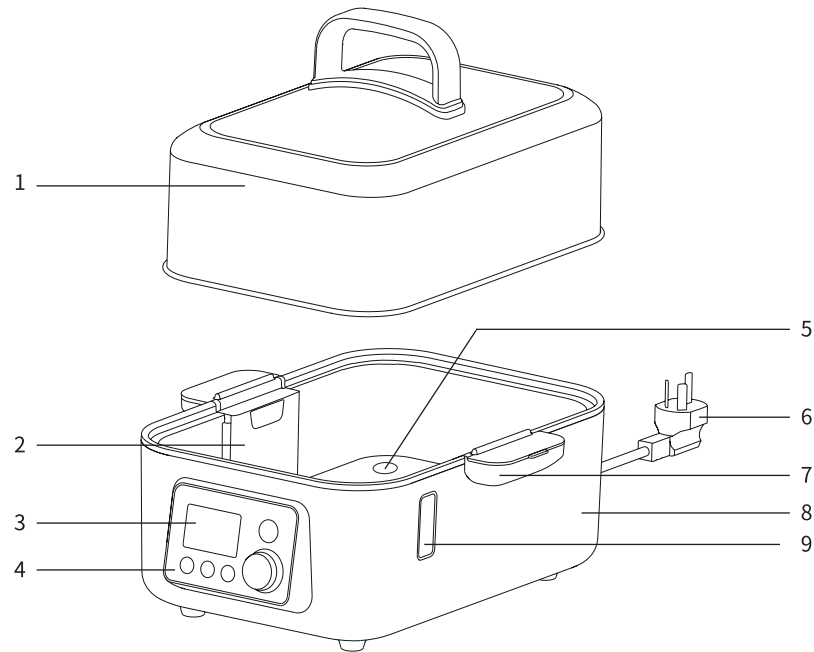

- | | | |
|----------------|---------------------|----------------------|
| 1 Lid | 4 Operational panel | 7 Handle / filler |
| 2 Steam baffle | 5 Water level Probe | 8 Pot body |
| 3 Screen | 6 Power cable | 9 water level window |

Understanding Product

Steamer components

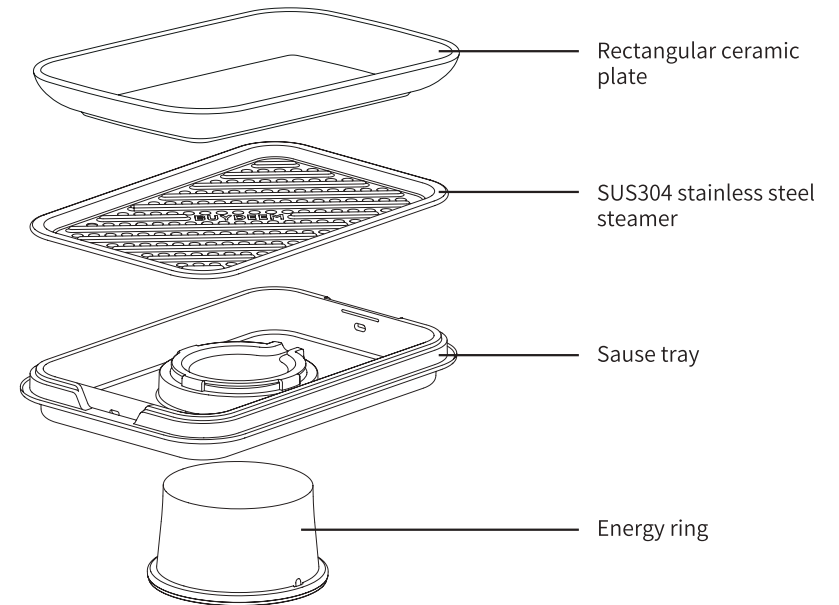

Slow cook components

- Available as standard on G563 only, G553 sold separately

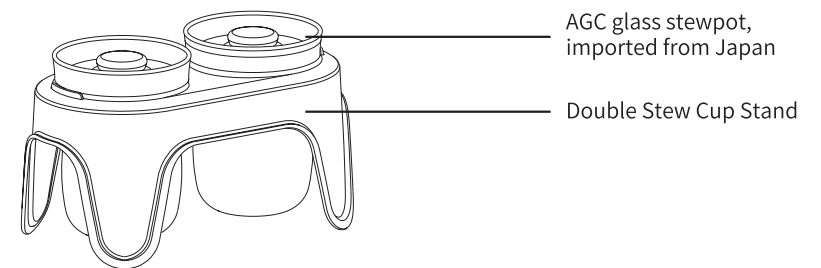

Understanding Product

Operational Panel

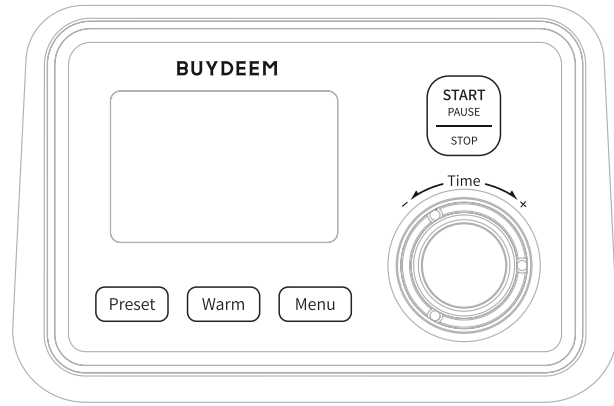

Button / knob	operation and function
Start / pause / stop button	Short press: start, pause
	Press and hold for 2 seconds: Stop working and enter standby mode
Menu button	Switch Steaming, Slow cook, and Yogurt cooking functions.
Warm button	Keep warm.
Preset button	Enter and exit the reservation mode.
Knob	Cooking time or reservation time.

Understanding Product

Function mode introduce.



Function type	Function name	Time range (knob)	Suggested water level	Function operation
Menu function	Steam	1-90 minutes	Greater than minimum water level	After steam filling, work in the steam mode until the set time counts down End.
	Slow cook	10 minutes to 6 hours	Water level before putting stew pot	After the water is boiled, work according to the stew mode until the set time countdown ends. After the program is over, the steamer cooker is kept warm for 6 hours.
	Yogurt	8-9.5 hours	water level before putting it in stew pot	After the water is heated to 40 ° C, it works in the yogurt mode until the countdown ends. When the temperature inside the pot is higher than 40 ° C, the steamer will stop working and beep, and the screen displays E1.
Preset function	Preset	15minutes-18hours	Maximum water level	The cooking process begins after the countdown of the scheduled time has elapsed. (Note: The appointment time does not include cooking time)
Warm function	Keep warm	10minutes-6 hours	maximum water level	The water is heated to a preset temperature and maintained at that temperature. Note: In the heat preservation state, when the temperature in the pot is higher than the preset temperature, the steamer cooker will wait until the water temperature drops to the preset temperature before holding the heat.
others	Add water	/	/	When the low water level detection device is activated, the word "add water" will be displayed, prompting the user to add water.

Notice: G553 / G563 pot body and G553 / G563 power cord must be used together. Do not connect power cords of other brands or power cords of other products of Buydeem.
Mix with G553 / G563, otherwise, it may not be cooked properly, and even short circuit, electric shock and other hazards may occur.

Understanding Product

Detailed introduction of components

Note: Please make sure that you wear the thermal insulation equipment every time you place the accessories, or wait for the temperature of the accessories to drop to room temperature before operation to prevent burns.

Steam baffle introduction

- You can remove the steam baffle cover during cooking and add water to the steamer through the external water inlet.
- When you lift the steam baffle cover, use a little force. After hearing a “click” sound, you can fix the baffle in the open position. You do not need to hold the baffle when adding water.

Pick-and-place method of steam baffle

Place

1. Make sure there are no accessories in the water tank

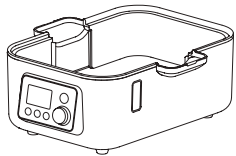

2. Align the slot between the baffle and the water tank

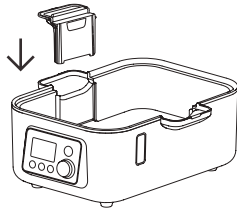

3. Place the bezel upright.

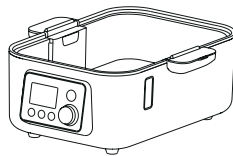

Take

1. Make sure there are no other accessories in the water tank;

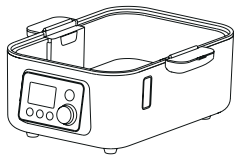

2. Hold the handle of the bezel and lift the bezel upright.

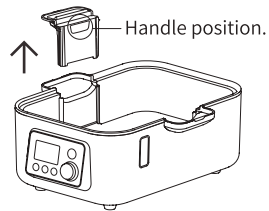

Cleaning precautions

- Please use sponge or soft cloth to scrub the baffle to avoid scratching;
- Do not use excessive force during cleaning, so as not to damage the connection part of the baffle.

Understanding Product

Steamed parts introduction

- Before using the “Steaming” function, please make sure that all the accessories of the steaming parts are correctly installed on the steamer.

How to put and put steamed parts

Place

1. Make sure the steam baffle is installed in the water tank;

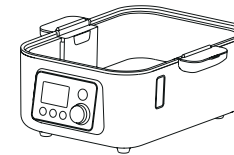

2. Put into the energy ring

Note: Make sure that the side of the ring with the convex edge and the small hole is facing down, and placed flat on the heating plate.

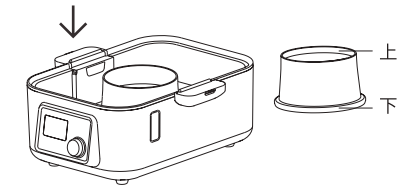

3. Put the sauce tray on the water tank;

Note: Please make sure the juice tray is properly placed, below the edge of the water tank.

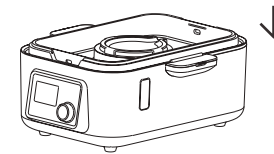

4. Place the steamer flat on the sauce tray.

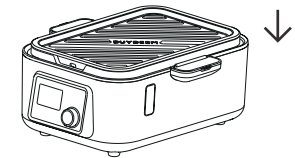

Understanding Product

Take

1. Make sure that the steamer or the saucepan has cooled down or that you are wearing thermal insulation equipment;

2. Take out the steamer;



3. Take out the sauce tray by holding the handle of the sauce tray;

4. Please wait for the water temperature in the water tank to drop to room temperature before taking the energy ring.

Notice: If the liquid in the sauce tray is full, the liquid is in the process of moving the juice tray, it may overflow through the vent holes and drip under the sauce tray. So Buydeem suggested you are diligent in pouring and cleaning the drip tray, so as not to spill or accumulate when handling. The liquid in the sauce pan has deteriorated.

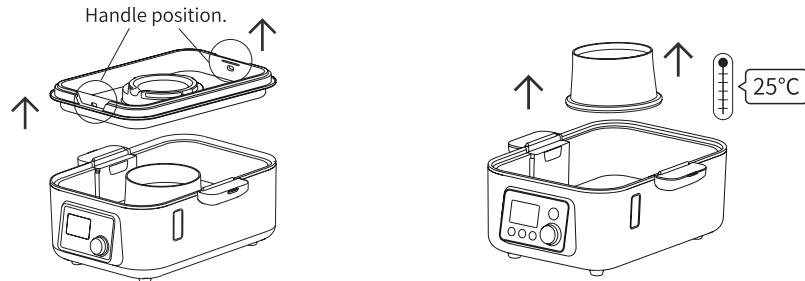

Cleaning precautions:

1. After each use, in order to avoid food spoilage, please wash it in time.
2. Please use sponge or soft cloth to clean the parts to avoid scratching

Understanding Product

Introduction of stew parts (glass stew pot and stand)

- Do not heat the glass saucepan directly over an open flame.
- Do not heat glass stew pots in an oven or microwave.
- The maximum effective capacity of the stew pot is 500 ml (70% full); please do not exceed this capacity to avoid the overflow of ingredients.
- Two glass stew pots are attached to the stew part. In actual use, only one stew pot or two stew pots can be used at the same time.

How to put glass stew pot and bracket

Installation and placement

1. Put the ingredients in the glass stew pot, and then put them into the holes of the stew pot on the stand;

2. Make sure there are no accessories other than the steam baffle in the water tank.

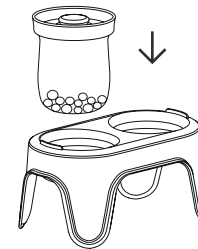

3. Add water to the "water level before placing the cup" in the steaming saucepan;

4. Hold the saucepan bracket tightly and put it gently into the steaming saucepan.

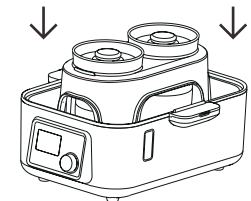
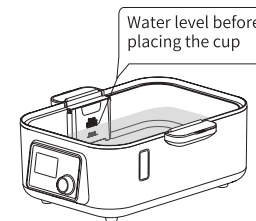

Understanding Product

Take

1. After wearing thermal insulation equipment or anti-scalding measures, open the lid;
2. Hold the stand and remove the stand and the stew pot from the steamer, and gently placed on a horizontal operating table.

3. Remove the stew pot.

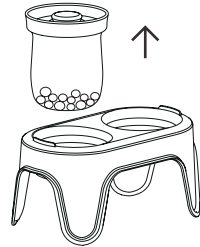
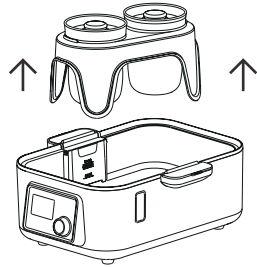

Cleaning precautions

1. The stew pot is made of glass. Please pay attention to avoid scratching or collision when cleaning. Even slight collisions may produce cracks that are hard to detect with the naked eye, and causes the saucepan to break when heated.
2. After using the stew pot, the user can put the stew pot in the rack for storage.

Understanding Product

First use

1. Remove all packaging, labels and accessories from the steamer.
Before using the product for the first time, we recommend that you make a boiling Point detection operation (see P21 detection method for details).

2. Boiling water for the first 2-3 times (select "steam" function, timing Choose 2 minutes.) It should be discarded for cleaning, then use a damp cloth to wipe the inside and outside of the steamer pot (note the power supply the cable connector must not come into contact with water).

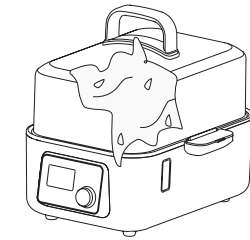
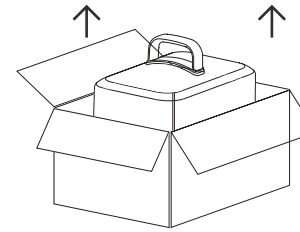

Quick installation

1. Plug the power cord into the steamer and make sure it is fully inserted.

2. Install or confirm that the steam baffle parts are properly inserted into the water tank, make sure the water level probe is clean and uncovered.

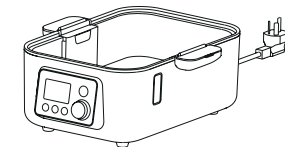
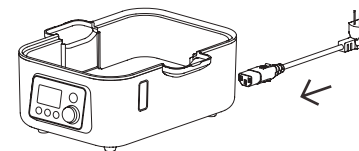

Using Product

Usage Instruction Steam

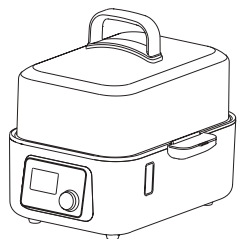

1. Place the steaming saucepan on a flat, clean, heat-resistant surface

- Dry the water on the bottom of the pot and the control panel.
- The steam cooker body must use its own power cord.
- Do not use when there is no water in the steamer.

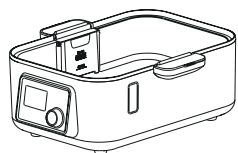

2 Open the lid and remove all accessories except the steam baffle according to the recommended method (see P8 for details).

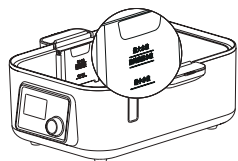

3. Add the right amount of purified water

- Never add water above or below the maximum level.
- If water is overfilled, the drip tray may be installed and water may overflow during cooking.

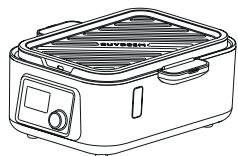

4. Install the steamer correctly on the water tank See P9 for installation steps.

Using Product

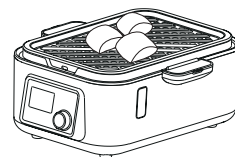

5. Add ingredients

- Please note that for ingredients that are easily affected by condensation, such as steamed bread and bread, it is recommended to place the ingredients directly on the steam rack or steam a steamer cloth between the plate and the ingredients. Steaming directly in the dishes may affect the taste of the ingredients.

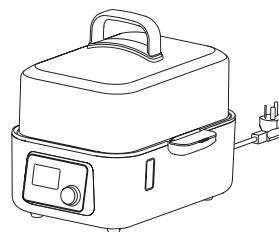

6. Tighten the lid

- Place the lid on the pot as shown in the figure, and gently pan the lid with your hand. If the lid is stable, the lid is tight.
- If the lid is not assembled properly, steam will escape from the gap during cooking, which may cause burns.
- Please note! When closing the lid, make sure that the steam hole on the lid is away from the back of the control panel, otherwise there may be a risk of burns during operation.

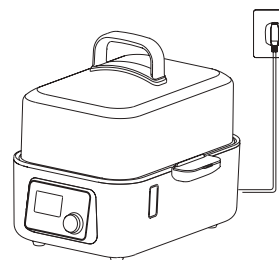

7. Plug in the power

- When the steamer is turned on, the buzzer will sound, and the screen will be displayed for one second and then enter the “steaming” function state, you can select the function, adjust the time and start working.

Using Product

Slow cook

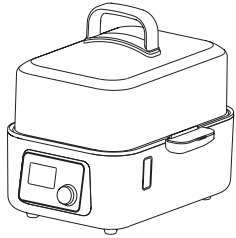

1. Place the steaming saucepan on a flat, clean, heat-resistant surface.

- Dry the water on the bottom of the pot and the control panel.
- The steam cooker body must use its own power cord.
- Do not use when there is no water in the steamer

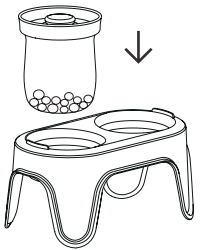

2. Put the food in the stew pot, add an appropriate amount of water, and install the stew pot and stand as shown on page

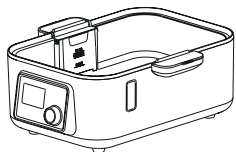

3. Make sure there are no accessories other than the steam baffle in the steamer

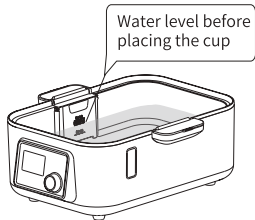

4. Add water in the steamer to the "Maximum for stew pot"

Using Product

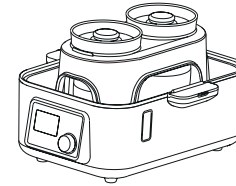

5. Put the stew pot and stand into the steamer

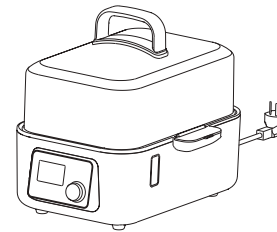

6. Tighten the lid

- Place the lid on the pot as shown in the figure, and gently pan the lid with your hand. If the lid is stable, the lid is tight.
- If the lid is not assembled properly, steam will escape from the gap during cooking, which may cause burns.
- Please note! When closing the lid, make sure that the steam hole on the lid is located away from the back of the control panel. There may be a risk of burns during operation.

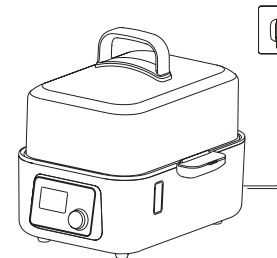

7. Plug in the power

- When the steamer is powered on, the buzzer will sound, and the screen will be displayed for one second before entering the default "slow cook" function state. You can start to select functions, adjust the time and start working.

Using Product

Guidelines for using functional modes

step 1: function selection;

Touch the function key to select any cooking function mode. The selected function flashes and the default duration of the current function appears at the top right of the screen. For the "slow cook" function, the cooking time is 60 minutes.

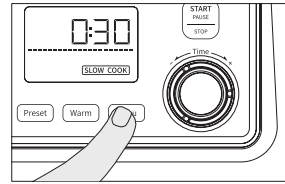

step 2: function selection;

Turn the knob to adjust the cooking time. If the stewing mode is selected, turn the knob to adjust the cooking time to 1.5 hour.

If you do not need to adjust the cooking time, you can skip to step 3.

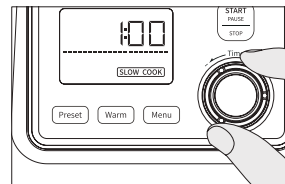

step 3: Confirm the function and time, then start;

Touch the "Start / Pause" key to enter the cooking phase;

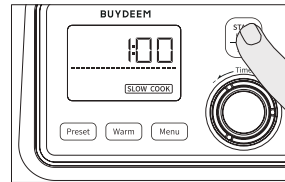

step 4: The cooking process.

When cooking starts, the display screen shows in stages. Taking the "steam" function as an example, they are:

1. The steamer cooker first heats the water to the specified temperature, the progress bar on the display scrolls, the cooking time does not change, and the "colon" in the cooking time does not flash.

2. When entering the medium-heat steam maintenance mode, the display progress bar continues to scroll, the cooking time starts to count down, and the "colon" in the cooking time starts to flash.

3. After cooking is finished, it will automatically stand by.

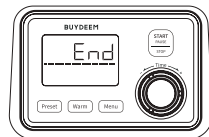
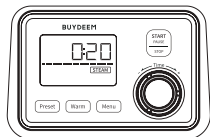

Tip: If it is the "slow cook" function, it will automatically enter the heat preservation function after cooking, and keep warm for 6 hours.

Using Product

Guidelines for the use of insulation functions

- The "Slow cook" function has a built-in heat preservation program for 6 hours. When using the "Slow cook" function, the steamer will automatically enter the heat preservation mode after the end of cooking, and a 6hour countdown will start.
- Due to the function and the particularity of the ingredients, the "Steam" function and the "Yoghurt" function do not provide an automatic insulation function.
- When holding heat-sensitive ingredients (such as seafood, vegetables, etc.), long-term heat preservation may affect the taste of the ingredients. Please pay attention to the heat preservation time.

Step 1: Function selection.

Touch the warm key.

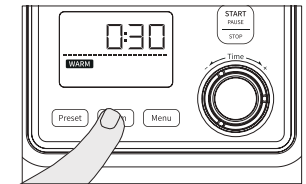

Step 2: Time adjustment.

Turn the knob to set the holding time. The manual insulation function is 30 minutes by default. You can select the length of insulation by the knob, such as 1 hour. If you do not need to adjust the holding time, you can skip to step 3.

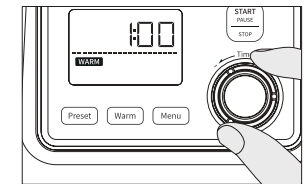

step 3: Function confirmation and start.

Touch the start / pause button to start the insulation function.

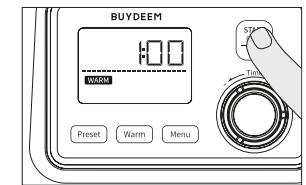

Using Product

Guidelines for using “Preset” function

- Due to the special nature of the ingredients, the "Yogurt" function cannot use the preset mode. When the preset time is set, when the function key is touched, the steamer will only switch between the "Steam" and "Slow cook" functions. If you need to use the "Yoghurt" function, you need to cancel the preset function before you can use it.

step 1: Make an preparation.

Touch the “Preset” button to enter the reservation time adjustment interface. You can adjust the reservation time by turning the knob. If you choose steam mode for 30 minutes, make an reservation for 8 hours. Note: The reservation time does not include cooking time.

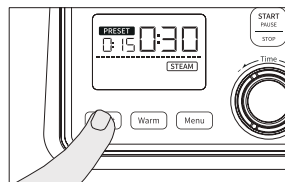

step 2: Reservation modification and cancellation.

In the preparation stage of the reservation, touch the “Menu” button to switch to the function / cooking time adjustment interface, and touch “Preset” button again to return to the reservation time adjustment interface. Note: In the reservation time adjustment interface, you can touch “Preset” button to cancel “Preset” function and return to the function / cooking time adjustment interface.

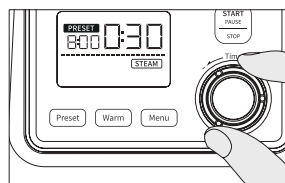

step 3: Confirm the Reservation

After adjusting the reservation time, function and cooking time, touch the "Start / Pause" key, the steamer will enter the reservation countdown, and the progress bar in the display will scroll.

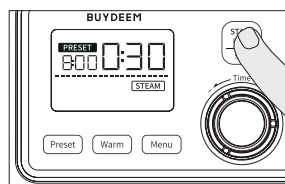

Guidelines for “add water” function

- Buydeenm steaming cooker has a built-in anti-dry-burning device that can detect the water level in the water tank in the pot to prevent the dry-burning of the heating plate from causing damage to the machine. Before using the steamer, make sure the water level probe is clean and uncovered.
- Due to the physical characteristics of water, the detection devices may be connected due to the presence of a water film. At this time, the water shortage reminder function will be temporarily disabled, but the dry burning protection device of the heating plate will continue to work to protect your machine.

- When the detection device detects the lack of water in the water tank, it will display "add water" on the display and emit a beep sound to remind the user.
- After encountering the water shortage prompt, please add an appropriate amount of water to the steamer. When the detection device detects that the water level returns to normal, the steamer will continue to work automatically.

Boiling point

Boiling point detection memory program

- In non-zero altitude areas, the water cannot reach 100 °C when it boils, which will cause the ordinary steamer to fail to work properly (too slow to break or even break normally).

Bei Ding recommends that you perform a boiling point detection operation for the first time and when you move to another city to use the steamer. After the test is completed, the chip will record accurate boiling point data, and subsequent tests do not need to be repeated.

- After boiling point detection, the steamer cooker can work more accurately (the performance is better than the factory setting).

* If you are in a city higher than 250m above sea level, be sure to perform boiling point detection before using.

Start boiling point detection

- Make sure that there are no other accessories except the steam baffle in the water tank. Add water to the maximum water level line. If the amount of water is insufficient or excessive, it will affect the test results.
- After connecting the power cord to the steamer, plug in the power cord to power on.

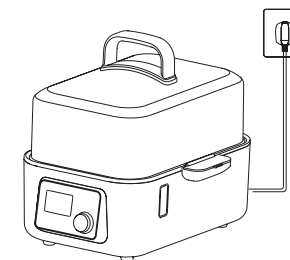
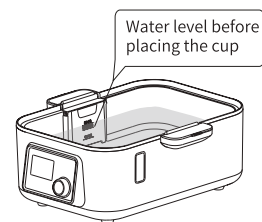

Boiling point

3. Within 30 seconds after power-on, press and hold the "Preset" and "Menu" buttons simultaneously for 2 seconds.

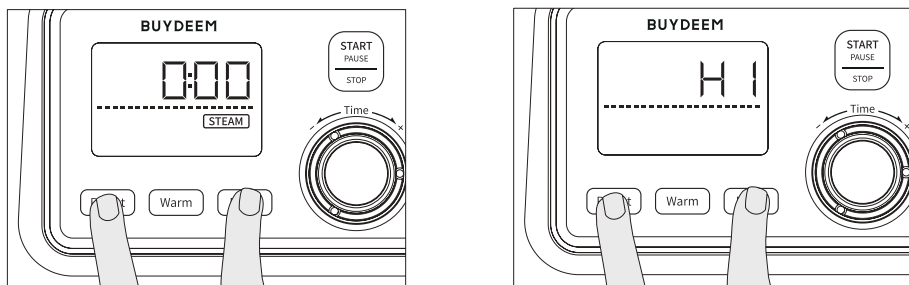

4. The screen flashes "H1". Press the "Start / Pause" button. The "H1" on the screen is always on, and the progress bar starts to scroll. The machine has now entered the detection state. After the test is completed, the machine beeps three times to end the work and enters the standby state.

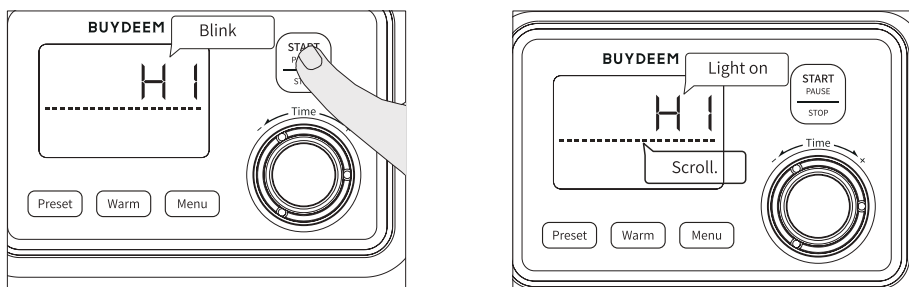

Features

Avoid misuse

The steaming stew can be switched in any mode within 1 minute of working according to the selected function mode.

In order to avoid misoperation, after the steamer cooker starts to work for 1 minute, except for the countdown time, you cannot switch the function at will. If you need to switch work

Yes, you need to press the "Start / Pause" button first, the screen display content flashes, and then select the function to be switched.

Cold water protection

During the cooking function, if you add cold water in the middle of cooking, the steamer will automatically heat the water to the preset temperature without worrying.

Cleaning & Maintaining

Cleaning and maintenance

Cleaning of the steamer

1. Unplug the power plug and unplug the power cord from the steamer.
2. After the steamer cooker cools, clean the inside of the water tank with a wet sponge.
Note: Do not immerse the steamer, power cord or plug in water (the power cord connector on the steamer should not come into contact with water)
3. After each use, in order to avoid the deterioration of food, grease and water in the steamer and saucepan, please clean it in time.

Descaling

The steaming saucepan needs to remove the scale regularly, and it is recommended to use it once a month. If the water quality is poor, the scale should be increased. Failure to clean the scale on time may cause the steamer to malfunction.

If there are spots on the heating plate, this is scale, which is a normal phenomenon. It can be cleaned by gently scrubbing with a clean cloth. If the situation is more serious, the following methods can be used for descaling.

Tips for descaling in a steamer

Using Buydeem descaling tablets:

- Add 500ml water and 5g descaling tablets to the water tank and let stand for 15 minutes;
- Activate the "Steam" mode and set the cooking time to 1 minute. After automatic power off, let stand for 5-10 minutes;
- After draining the water, wash with water for 5-6 times, repeat if necessary.

Use white vinegar:

- Add 100ml white vinegar to the water tank;
- Add 500ML water to the water tank;
- Activate the "Steam" mode and set the cooking time to 1 minute. After automatic power off, let stand for 5-10 minutes;
- After draining the water, wash with water for 5-6 times, repeat if necessary.

Simple Troubleshooting

Simple Troubleshooting

Failure phenomenon	Cause Analysis	Troubleshooting
After installation, no prompt sound and key lights are off	No power connection	Check if the plug is properly inserted into the socket. If there is a switch, please confirm whether the switch is on
	The steamer and the power cord are not connected in place	When connecting the power cable to the steamer, make sure it is connected
	Steamer is not working	It is recommended to contact Buydeem's customer service centre or send Service Point Repair
The machine stops working after heating for 10 seconds, and stops automatically after 5 short beeps (display E1)	High temperature of water temperature in the machine	Generally, this condition will appear in yogurt and other functions, indicating that the water temperature in the pot is higher than the temperature set by the program. Please add cold water before continuing to work
The screen of the steaming stew is black. After being awakened by operation, the screen displays E2.	Dry burn protection	After cooling the steamer, unplug the power and then turn it on. If there is no water in the water tank, observe whether there is a water shortage prompt on the screen. If there is a shortage of water, please add water and continue to use it; if there is no shortage of water, please see the next item
No water in the water tank but no water shortage warning	Water level detection failure	After drying the water tank, observe if there is any indication of water shortage. If there is a shortage of water, you can continue to use it normally; if there is no shortage of water, you are advised to contact Buydeem's customer service centre or send the service point for repair
	Steamer is not working	It is recommended to contact Buydeem's customer service centre or send the service point for repair.
Water smells	Unused new steamer	It is recommended to boil the water for several times before using it in a new steamer. If the condition persists, fill the water to the highest level, add two teaspoons of soda, pour it after boiling, and clean the steamer.

Simple Troubleshooting

显示屏故障代码对应表

Display code	cause of issue	solution
E1	over temperature warning	Use pure water below target temperature
E2	Dry burning	Refer to the handling methods in the table above
E3	Malfunction of temperature sensing parts	It is recommended to contact Buydeem's customer service centre or send the service point for repair.
E4	Plateau warning	It is recommended to perform the boiling point detection procedure according to P21. If this alarm signal still appears repeatedly after the detection, it is recommended to contact Buydeem's customer service centre or send the service point for repair.
E5	Power switching failure	It is recommended to contact Buydeem's customer service centre or send the service point for repair.
H1	Enter the boiling point detection program by mistake.	Just turn it off and then on again
H2	Enter the boiling point recovery program by mistake	Just turn it off and then on again

Warranty & Service

Warranty and service description

If the product is damaged in detail, please contact Buydeem's customer service centre or send the service point for repair.

- The warranty is limited to production defects and damage caused by correct use in accordance with the instructions. Damage caused by improper use or other non-product quality issues will be charged for repairs.
- If you need to purchase product spare parts, please contact Buydeem's official email Support-US@buydeem.com

The following conditions will not be repaired free of charge

- No Guarantees Certificate or valid invoice.
 - Failure caused by failure to operate in accordance with the instructions
- A. Damage caused by improper use, storage and maintenance by consumers.
B. Damage caused by repairs not performed by the company's designated maintenance department.
C. Damage due to force majeure.

For the benefit of customers, Buydeem reserves the right to modify product features and components to ensure the normal use of the product.

If you need more services and information, or have any questions, please please contact Buydeem's official email Support-US@buydeem.com, and our professional staff will help you solve.

Warranty & Service

BUYDEEM

G553/G563

多功能蒸炖锅

使用说明书

Warranty card

BUYDEEM

Dear Customer,

Thank you so much for your purchase! The product comes with a ONE-YEAR warranty.

Should you ever needs one, please have the following information handy whenn
contactinng us:

Product Model No: _____ Product Name: _____

Factory Serial No: _____ Purchase Date: _____

Customer Name: _____ Customer Phone: _____

Please feel free to email us if you have any questions or concerns.

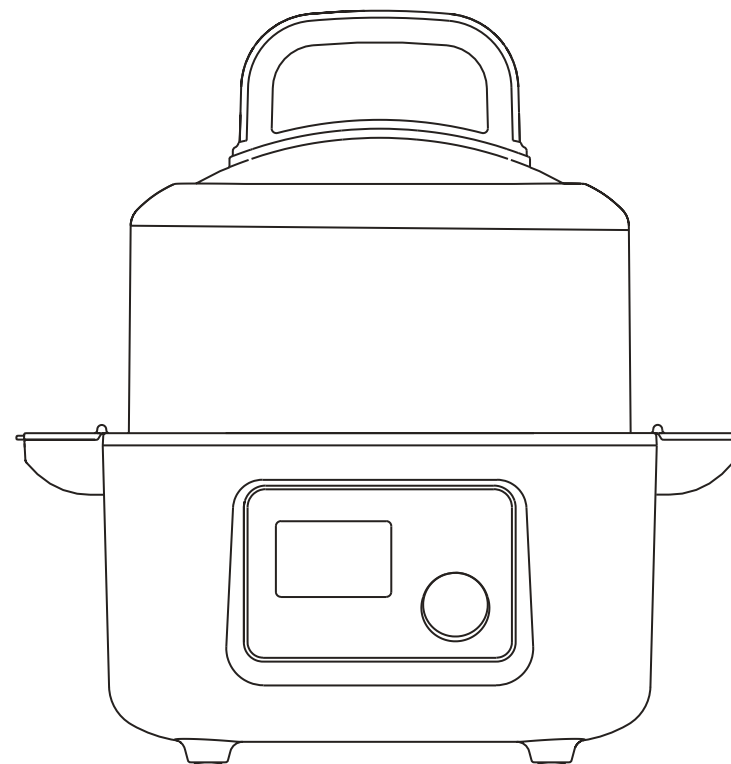

感谢您购买北鼎产品，为了能让您充分享受北鼎全方位的支持，
使用本产品之前请详细阅读本说明书及相关图解。

目录

Contents

注意事项	32	使用产品	43~50
技术规格	33	初次使用	43
认识产品	34~42	快速安装	43
产品结构图	34	使用指引	44
操作面板介绍	36	沸点检测	51
功能模式介绍	37	特色功能	53
部件介绍	38	清洁和保养	54
		简单故障处理	55
		保修和服务	57

⚠ 危险

▪ 为防止触电或短路等危险，请勿将蒸炖锅、电源线及插头置于水中或其它任何液体中，也不要放在水龙头下冲洗。

⚠ 警告

- 使用前请核对产品规格标贴上显示的电压与所在地区主电压是否一致。
- 儿童、老年人、肢体或精神能力受限人士及无使用经验人士应在监督 and 指导下使用产品，并保证其安全。儿童应在监管下接触本产品，以确保他们不会将产品当成玩具玩耍。
- 本产品必须单独使用额定电流10A以上，额定电压120V~60Hz的接地插座。插头需完全插入插座，以防接触不良而导致元件过热烧坏，引发短路或火灾等危险。
- 切勿使用万能插座。
- 请将蒸炖锅、蒸炖锅的各种配件以及电源线远离高温、明火、潮湿、光滑的台面或锋利的边缘，以防引起器件损坏、故障或火灾。
- 手沾水或赤脚时禁止使用蒸炖锅。
- 请特别注意使用时的烫伤风险！蒸炖锅在工作时，各处表面及其内部（例如蒸架、积汁盘等）会达到很高的温度，并且在电源断开后仍然维持高温一段时间。请在使用时佩戴隔热装备后再进行操作，避免直接接触高温表面，以防烫伤。

⚠ 注意

- 本产品仅设计为家庭使用，厂商仅对生产瑕疵和家用故障进行保修；任何商业用途、不适合用途或未遵照说明操作而造成的后果与故障，厂商均不负任何责任，此等故障损坏均不属于保修范围内。
- 本产品必须和其配套的电源线一起使用，请勿使用其它电源线。
- 请始终将蒸炖锅放置在平坦、稳固、耐热的工作台上。
- 使用产品前，请务必确认锅盖已正确盖好，以防蒸汽逸出造成烫伤。
- 蒸炖锅在工作期间会产生高温和蒸汽，请勿在工作期间以非正确方式触碰、揭开或移动蒸炖锅的锅盖，请勿靠近蒸汽出口等高温区域，以防烫伤。
- 请避免将工作状态下的蒸炖锅放置在对水汽敏感的家具（例如木制橱柜、茶几等）附近或下方。
- 请勿将密闭的容器放置在蒸炖锅内加热，以防引起爆炸的危险。
- 请勿在超过最大水位或低于最低水位的情况下运行蒸炖锅；水箱内装水过满，可能会引起沸水溅出，水箱内装水过少，可能会引起干烧。
- 蒸炖锅正在工作时，不要移动蒸炖锅或在蒸炖锅的上方活动，以免引起故障或者烫伤。
- 取下锅盖时请小心，以免凝结水从锅盖中流出后烫伤人体。

⚠ 注意

- 切勿触摸本产品的高温表面。处理本产品的高温部件以及食物器皿时，务必使用隔热手套。同样，食物烹煮好之后，需从蒸炖锅中取出时，为防止热蒸汽逸出烫伤人体，请使用手套或护具取用食物及其器皿。
- 蒸炖锅要防潮、防冻，请勿将蒸炖锅放进冰箱或置于阳光直射处。亦请勿在有易爆或可燃气体的环境中操作本产品。
- 为防止触电或火灾，请保证下列情况下电源处于断开的状态：水箱无水时、不使用蒸炖锅时、清洁或移动蒸炖锅时、蒸炖锅部件损坏时、当蒸炖锅出现故障时。
- 如果长时间不使用蒸炖锅，建议将蒸炖锅内的水倒掉。
- 如需拔下插头，请确保手部干爽并握住插头再拔出，请勿强行拉扯或扭曲电源线，以防电源线损坏，产生漏电危险。
- 请不要让电源线悬挂在桌子或工作台面边缘之外，以防蒸炖锅掉落，或引起绊倒。
- 请不要使用非官方推荐的方法去除水垢。推荐方法详见P24。
- 如发现或怀疑蒸炖锅部件损坏（例如蒸炖锅曾从高处坠落或遭受可能导致内部损坏的事故）或蒸炖锅不能正常工作时，请立即拔掉电源插头，切勿继续使用或自行拆除。请前往北鼎授权的服务中心进行更换或维修。联系方式详见P28。
- 除了按照说明书进行清洁和除垢，其它任何非正常使用操作必须由北鼎授权的服务中心进行。
- 由于未对蒸炖锅进行除垢造成其不能正常使用或完全不能使用的，不属于保修范围。
- 所有产品均严格按照质量控制程序进行检验，其中包括对随机抽检产品的实际使用测试，故其将对产品的任何使用痕迹作出解释。

技术规格

产品名称	多功能蒸炖锅		产品型号	G553/G563	
产品功率	1500W	最大容量	2.0L	电压	120V~60Hz

本产品采用食品接触用材质：

SUS316L (022Cr17Ni12Mo2) 以及SUS304 (06Cr19Ni10) 不锈钢、聚丙烯PP塑料、食品接触用硅胶

产品结构图

锅盖及锅身

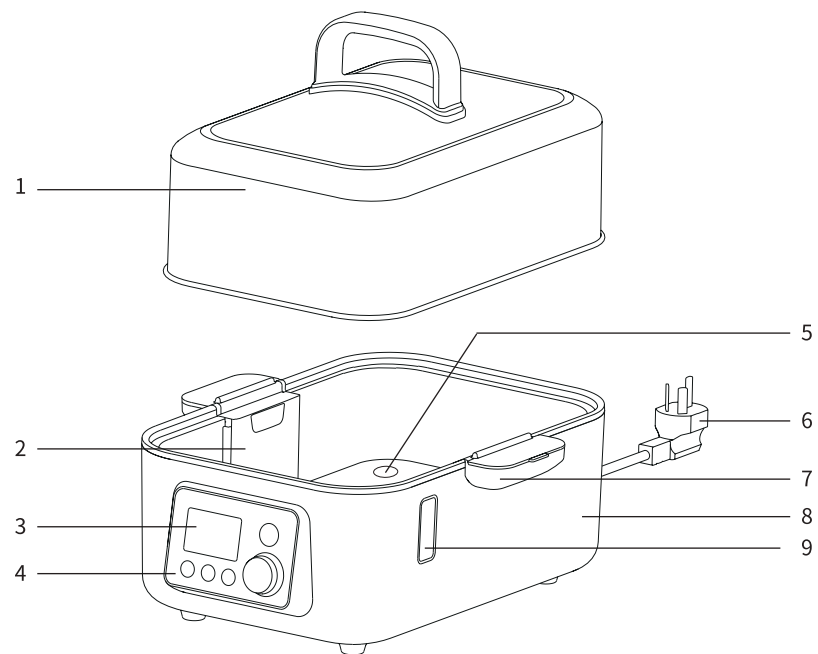

- | | | |
|--------|--------|----------|
| 1 锅盖 | 4 操作面板 | 7 把手/注水口 |
| 2 蒸汽挡板 | 5 水位探头 | 8 锅身 |
| 3 屏幕 | 6 电源线 | 9 水位窗 |

蒸部件

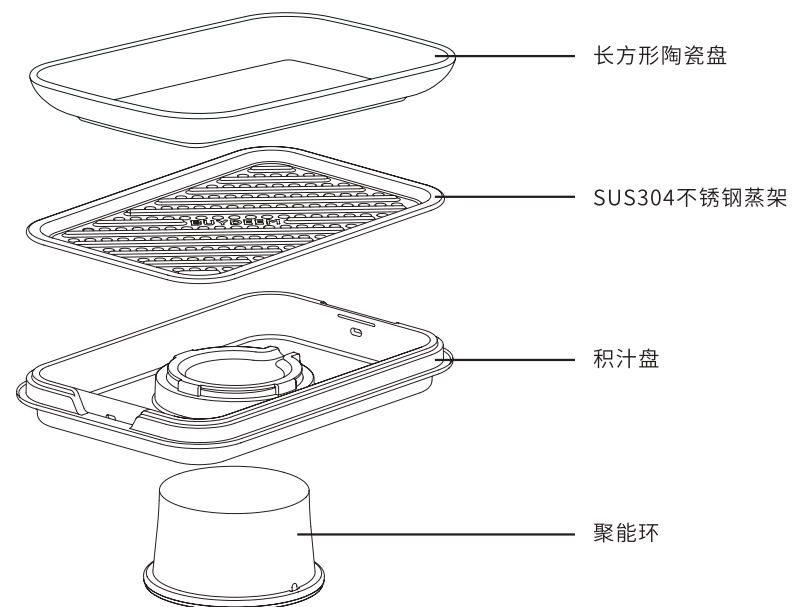

炖部件

▪ 仅在G563上作为标准配件, G553需要另行购买

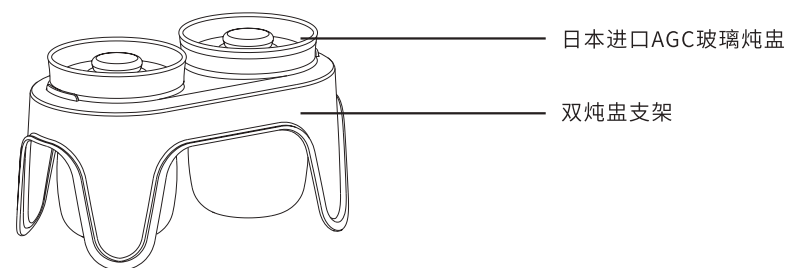

操作面板介绍

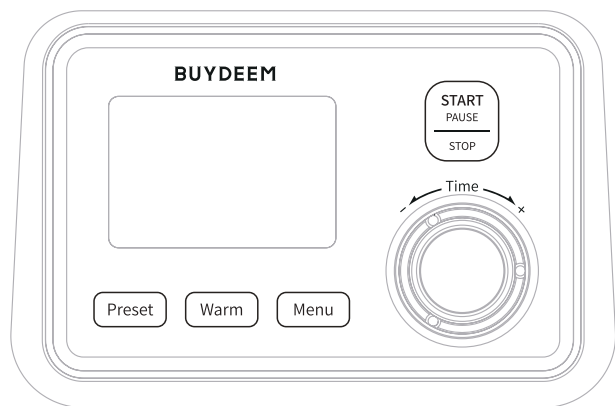

按键/旋钮	操作与功能
开始/暂停/停止键	短按: 开始、暂停。
	长按2秒: 停止工作, 进入待机状态。
功能键	切换蒸、炖、酸奶烹煮功能。
保温键	进入保温功能。
预约键	进入以及退出预约模式。
旋钮	调整烹煮时间或者预约时间。

功能模式介绍



功能类型	功能名称	时间范围(旋钮)	建议水位	功能运作方式
烹煮功能	蒸	1-90分钟	大于最小水位	蒸汽充盈后按照蒸模式工作至设定时间倒数结束。
	炖	10分钟-6小时	放盅前水位	水烧开后按照炖模式工作至设定时间倒数结束。程序结束后, 蒸炖锅自动保温6小时。
	酸奶	8-9.5小时	放盅前水位	水加热至40°C后按照酸奶模式工作至设定时间倒数结束。当锅内温度高于40°C时, 蒸炖锅将停止工作, 并蜂鸣警告, 屏幕显示E1。
预约功能	预约	15分钟-18小时	最大水位	在预约设定时间倒数结束后开始烹煮程序。 (注意: 预约时间不包含烹煮时间)
手动保温功能	保温	10分钟-6小时	最大水位	水加热至预设温度并维持该温度。注意: 保温状态下, 当锅内温度高于预设温度时, 蒸炖锅将待水温降至预设温度后再进行保温。
其他	缺水	/	/	低水位检测装置被激活时, 将会显示“缺水”二字, 提示用户加水。

注意! 必须配套使用G553/G563身及G553/G563电源线, 切勿将其他品牌电源线或北鼎其他产品的电源线与G553/G563混用, 否则可能出现无法正常烹煮的情况, 甚至出现短路、触电等危害。

部件详细介绍

注意:每次取放各配件时,请确保已穿戴好隔热设备,或等待配件温度降低至室温后再操作,以防烫伤。

蒸汽挡板介绍

- 可在烹煮过程中揭开蒸汽挡板盖,通过外置注水口为蒸炖锅加水。
- 揭开蒸汽挡板盖时,稍微用力,听到“咔哒”一声之后,可将挡板固定在开启的位置,加水时无需扶着挡板。

蒸汽挡板的取放方式

放置

1.确认水箱内无配件;

2.对准挡板与水箱之间的槽位;

3.竖直将挡板放入。

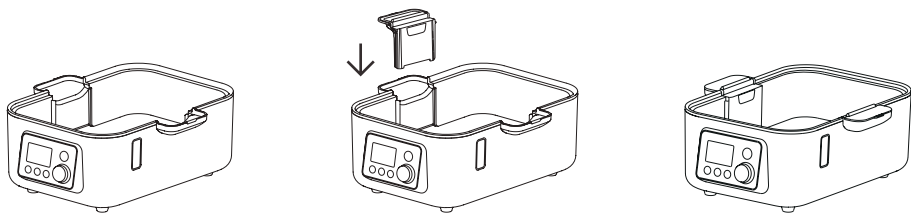

拿取

1.确认水箱中无其他配件;

2.握住挡板的把手位将挡板竖直提出。

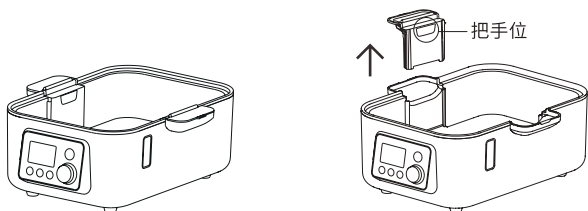

清洗注意事项

- 请使用海绵或者柔软的抹布对挡板进行擦洗,以避免刮花;
- 清洗时请勿过度用力,以免损坏挡板连接部位。

蒸部件介绍

- 请在使用“蒸”功能前务必确认蒸部件的所有配件均正确安装于蒸炖锅上。

蒸部件的取放方式

放置

1.确认水箱内已安装好蒸汽挡板;

2.放入聚能环;

注意:请确认聚能环带有凸边以及小孔的一边朝下,并且平整地放在了发热盘上。

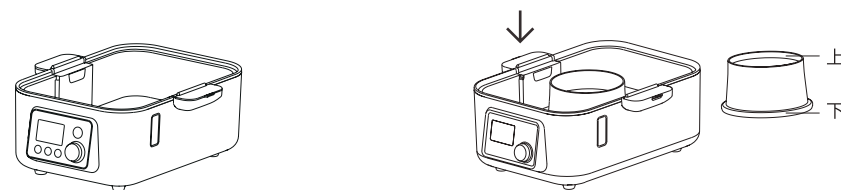

3.将积汁盘放在水箱上;

4.将蒸架平整地放在积汁盘上。

注意:请确认积汁盘已妥善放好,积汁盘四边都低于水箱边缘。



拿取

1. 确保蒸炖锅已经冷却或者确保已佩戴隔热设备；

2. 取出蒸架；



3. 手握积汁盘的把手位取出积汁盘；

注意：若积汁盘中的液体已存满，移动积汁盘的过程中液体可能会通过透气孔溢出，滴溅在积汁盘下方。因此北鼎建议您勤于倾倒以及清洗积汁盘，以免拿取时液体溢出或者积汁盘内的液体变质。

4. 请注意等待水箱内水温降至室温后再拿取聚能环。

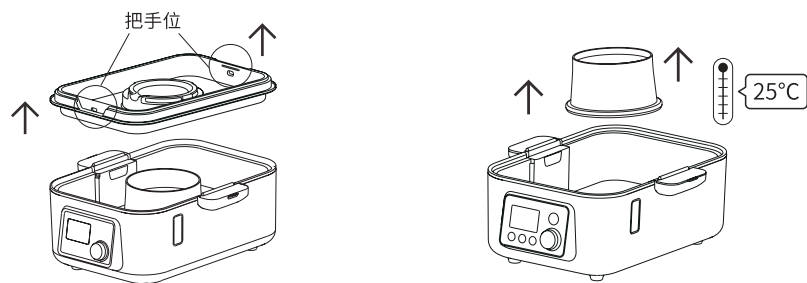

清洗注意事项

1. 每次使用后，为避免食物变质，请及时清洗。
2. 请使用海绵或者柔软的抹布对零部件进行清洗，以避免刮花。

炖部件(玻璃炖盅以及支架)介绍

- 请勿将玻璃炖盅直接明火加热。
- 请勿将玻璃炖盅放入烤箱或微波炉内加热。
- 炖盅的最大有效容量为500毫升(7成满)；请勿超出此容量，以免食材溢出。
- 炖部件中附有两个玻璃炖盅，实际使用时，可只使用一个炖盅，也可两个炖盅同时使用。

玻璃炖盅及支架的取放方式

安装以及放置

1. 在玻璃炖盅放入食材，然后放入支架的炖盅孔中；

2. 确保水箱中没有除了蒸汽挡板以外的配件；

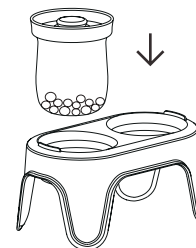

3. 在蒸炖锅中加水至“放盅前水位”；

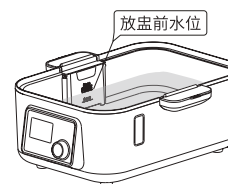

4. 握紧炖盅支架，轻放入蒸炖锅内。

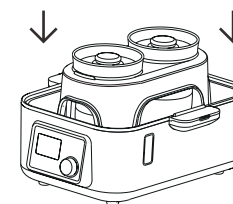

拿取

1. 佩戴好隔热设备或者做好防烫措施之后, 打开锅盖;
2. 握住支架将支架连同炖盅一并从蒸炖锅取出, 并轻轻放置在水平的操作台上;

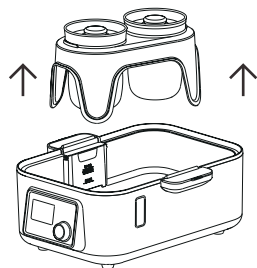

3. 取出炖盅。

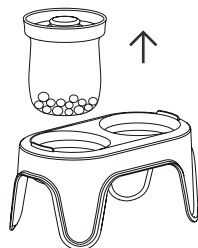

清洗注意事项

1. 炖盅为玻璃制品, 清洗时请注意避免刮伤或者碰撞。即使是轻微的碰撞也有可能产生肉眼难以察觉的裂痕, 并导致炖盅在受热时破裂。
2. 用户可在使用完炖盅后将炖盅置于支架中收纳。

一、初次使用

1. 去除蒸炖锅内所有包装, 标签及附件。
在初次使用产品之前, 我们建议您做一次沸点检测操作 (详见P21检测方法)。

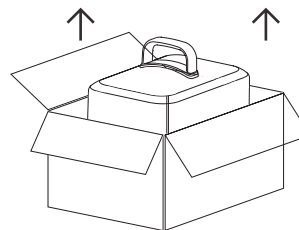

2. 前2-3次烧开的水 (选择“蒸”功能, 定时选择2分钟即可) 应该倒掉用于清洁, 然后用湿布擦拭蒸炖锅部件的内外部 (请注意电源线连接器不可接触水)。

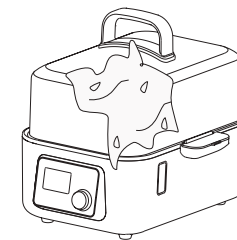

一、快速安装

1. 将电源线插入蒸炖锅并确认已经完全插入。
2. 安装或确认蒸汽挡板部件已正确插入水箱, 确保水位探头清洁并且未被覆盖。

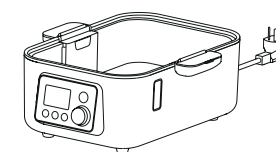
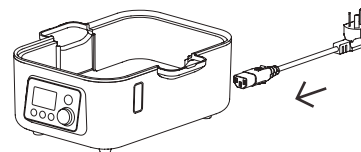

使用指引

蒸

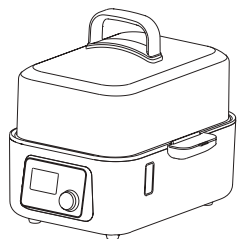

1. 将蒸炖锅放在平坦、干净的耐热台面上

- 请将锅底及控制面板上的水擦干。
- 蒸炖锅锅身必须使用专属的电源线。
- 蒸炖锅内无水时请勿使用。

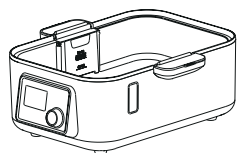

2. 打开锅盖,按推荐方法(详见P8)取出除蒸汽挡板以外所有配件

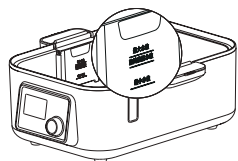

3. 加入适量的净水

- 切勿加水超过最大水位或低于最小水位。
- 若加水过满,安装积汁盘以及烹煮时水可能会溢出。

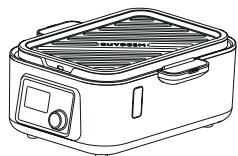

4. 将蒸部件正确安装在水箱上 安装步骤详见P9。

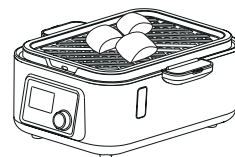

5. 加入食材

- 请注意,对于馒头、面包等容易受冷凝水影响的食材,建议将食材直接放在蒸架上或者在盘子与食材之间垫一层蒸笼布蒸制。若直接放在碗中蒸制可能会影响食材的口感。

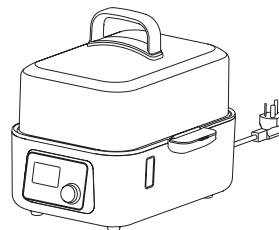

6. 盖紧锅盖

- 将锅盖按图示位置放置在锅身上,用手轻轻平移锅盖,若锅盖稳定,表示盖子合紧。
- 如盖子装配不到位,烹煮时,蒸汽会从缝隙处逸出,可能会造成烫伤。
- 请注意!盖上锅盖时,请确认锅盖上的蒸汽孔位于远离控制面板的右侧,否则操作时可能会有烫伤风险。

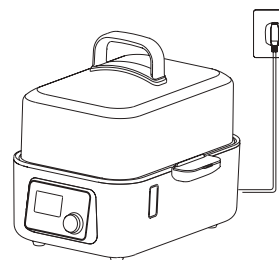

7. 插上电源

- 当蒸炖锅通电后,蜂鸣器发出响声,屏幕全显一秒后进入“蒸”功能状态,即可选择功能、调整时间并开始工作。

炖

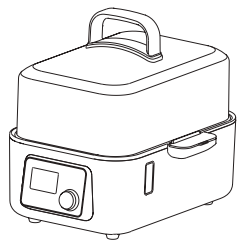

1. 将蒸炖锅放在平坦、干净的耐热台面上

- 请将锅底及控制面板上的水擦干。
- 蒸炖锅锅身必须使用专属的电源线。
- 蒸炖锅内无水时请勿使用

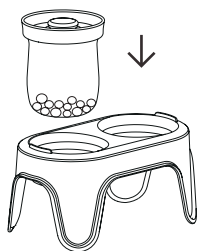

2. 将食物放入炖盅内,加入适量的水,按P11页所示安装好炖盅以及支架

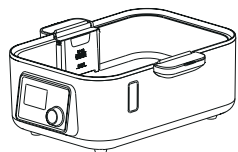

3. 确保蒸炖锅内无除了蒸汽挡板以外的配件

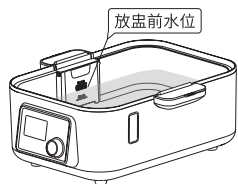

4. 在蒸炖锅中加水至“放盅前水位”

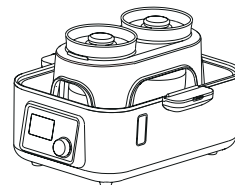

5. 将炖盅及支架放入蒸炖锅内

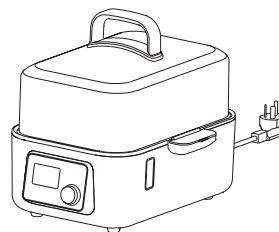

6. 盖紧锅盖

- 将锅盖按图示位置放在锅身上,用手轻轻平移锅盖,若锅盖稳定,表示盖子合紧。
- 如盖子装配不到位,烹煮时,蒸汽会从缝隙处逸出,可能会造成烫伤。
- 请注意!盖上锅盖时,请确认锅盖上的蒸汽孔位于远离控制面板的右侧,则操作时可能会有烫伤风险。

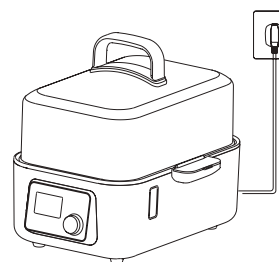

7. 插上电源

- 当蒸炖锅通电后,蜂鸣器发出响声,屏幕全显一秒后进入默认的“蒸”功能状态,可开始选择功能、调整时间并开始工作。

功能模式使用指引

step 1: 功能选择;

轻触功能键选择任意烹煮功能模式, 选定功能跳闪, 屏幕右上方出现当前功能默认时长。如“炖”功能, 烹煮时间为30分钟。

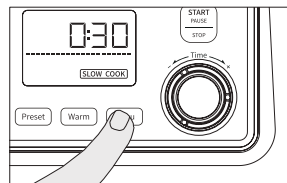

step 2: 时间调节;

旋转旋钮调节烹煮时间。如选定炖模式, 旋转旋钮调节烹煮时间为1小时。

若无需调节烹煮时间, 可直接跳至step3。

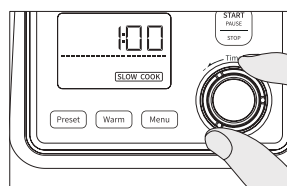

step 3: 功能、时间确认并开始;

轻触“开始/暂停”键进入烹煮阶段;

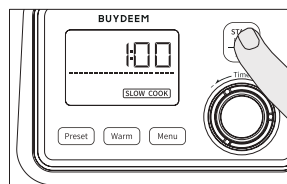

step 4: 烹煮过程。

当烹煮开始后, 显示屏呈阶段性显示, 以“蒸”功能为例, 分别为:

1. 蒸炖锅先大火将水加热至指定温度, 显示屏进度条滚动显示, 烹煮时间不变, 烹煮时间中的“冒号”不闪动。

2. 进入中火蒸汽维持模式时, 显示屏进度条继续滚动显示, 烹煮时间开始倒计时, 烹煮时间中的“冒号”开始闪动。

3. 烹煮结束后, 自动待机。

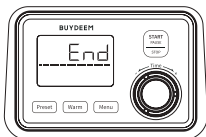
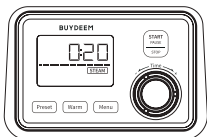

提示: 如果是“炖”功能, 烹煮结束后将自动进入保温功能, 保温6小时。

保温功能使用指引

- “炖”功能内置了6小时的保温程序, 在使用“炖”功能时, 烹煮结束后蒸炖锅将自动进入保温模式, 开始6小时的倒计时。
- 因功能以及食材特殊性, “蒸”功能以及“酸奶”功能不提供自动保温功能。
- 在对火候较敏感的食材(如海鲜、蔬菜等)进行保温时, 长时间的保温可能会对食材的口感产生影响, 敬请注意保温时长。

step 1: 功能选择。

轻触保温键。

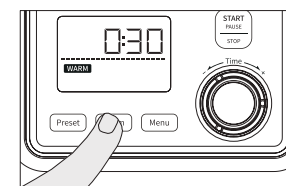

step 2: 时间调节。

旋转旋钮设定保温时间。手动保温功能默认为30分钟, 通过旋钮可以选择保温的时长, 例如1小时。如无需调节保温时间, 可直接跳至第三步。

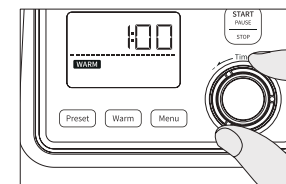

step 3: 功能确认并开始。

轻触开始/暂停键, 即可开始保温功能。

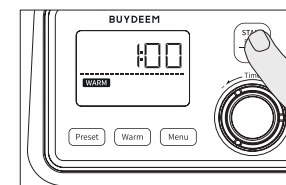

预约功能使用指引

- 因食材特殊性，“酸奶”功能无法使用预约模式，在已设定预约时间的情况下，轻触功能键时，蒸炖锅只会在“蒸”“炖”两功能之间进行切换。如需使用“酸奶”功能，需要取消预约功能后方可选择使用。

step 1: 预约准备。

轻触预约键可进入预约时间调节界面，可通过旋转旋钮调节预约时间。如选择蒸模式30分钟，预约8小时。注意：预约时间不包括烹煮时间。

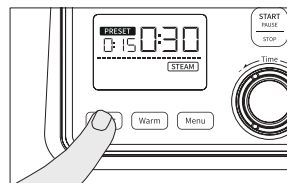

step 2: 预约修改以及取消。

在预约准备阶段，轻触功能键可以切换至功能/烹煮时间调节界面，再次轻触预约键则可回到预约时间调节界面。注意：在预约时间调节界面时，可轻触预约键取消预约功能并回到功能/烹煮时间调节界面。

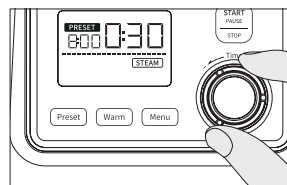

step 3: 预约确认。

调节好预约时间、功能及烹煮时间后，轻触“开始/暂停”键，蒸炖锅进入预约倒计时，显示屏中的进度条滚动显示。

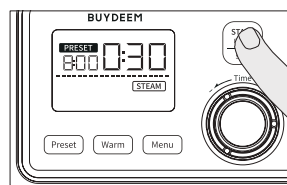

缺水提示功能使用指引

- 北鼎蒸炖锅在锅身中内置了可检测水箱内水位的防干烧装置，防止发热盘干烧对机器造成损害。使用蒸炖锅前，请确保水位探头清洁且未被覆盖。
- 由于水的物理特性，检测装置之间有可能会由于水膜的存在而被连通，此时缺水提醒功能将会暂时失效，但是发热盘的干烧保护装置将会持续工作，保护您的机器。

- 当检测装置检测到水箱缺水时，将会在显示屏上显示“缺水”，并发出蜂鸣声，提醒用户。
- 遇到缺水提示之后，请往蒸炖锅内加入适量的水。当检测装置检测到水位恢复正常之后，蒸炖锅将会自动继续工作。

沸点检测记忆程序

- 在非零海拔地区，水在沸腾时无法达到100°C，这将导致普通蒸炖锅无法正常工作（跳过过慢甚至无法正常跳断）。
- 北鼎建议您在第一次使用以及移动到另一城市使用蒸炖锅时，均进行一次沸点检测操作。检测完成后，芯片将记录精确沸点数据，后续使用无需重复检测。
- 经过沸点检测后，蒸炖锅能更精准地工作（性能比出厂设置时更佳）。

* 若您处于海拔高于250m的城市，请务必进行沸点检测操作后再使用。

启动沸点检测

- 确保水箱内无除了蒸汽档板以外的其他配件，加水至最大水位线处，水量不足或过多时，会影响检测结果。
- 将电源线连接至蒸炖锅后，将电源线插入电源通电。

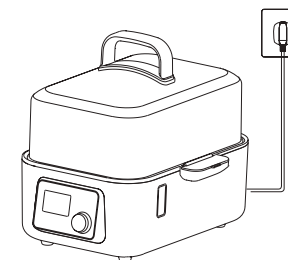
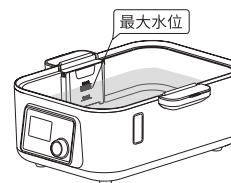

3. 通电后的30秒内,同时按住“预约”和“功能”按键,保持2秒。

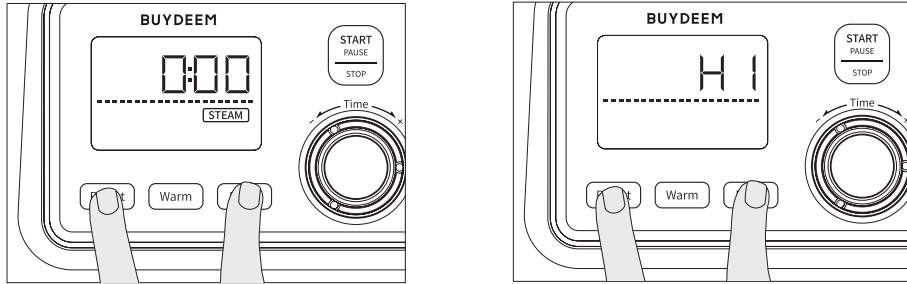

4. 屏幕闪烁显示“H1”,按一下“开始/暂停”键,屏幕上的“H1”常亮,进度条开始滚动显示。

此时机器已进入检测状态。检测完成后机器长鸣三声结束工作,并进入待机状态。

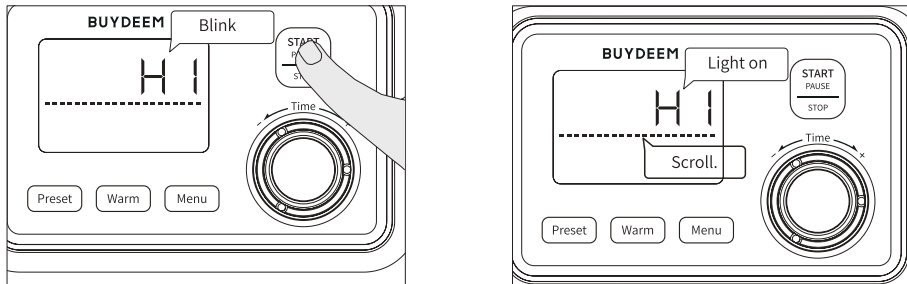

避免误操作

蒸炖锅按照所选功能模式进行工作的1分钟内可任意切换模式。

为了避免误操作,蒸炖锅开始工作1分钟后,除了正在倒数的时间以外,不能随意切换功能。若需要切换功能,需先按“开始/暂停”按键,屏幕显示内容闪烁,再选择需要切换的功能。

冷水保护

在执行烹煮功能时,如在烹煮中途加入冷水,蒸炖锅会自动将水加热至预设温度,无需担心。

清洁和保养

蒸炖锅的清洗

1. 拔下电源插头, 将电源线从蒸炖锅上拔出。
2. 待蒸炖锅冷却后, 用湿海绵清洗水箱内部。

注意: 切勿将蒸炖锅、电源线或插头浸泡在水中 (蒸炖锅上的电源线连接器不可接触水)

3. 每次使用后, 为避免蒸炖锅以及积汁盘内的残留食物、油脂和水变质, 请及时清洗。

除水垢

蒸炖锅需要定期清除水垢, 建议每月一次, 如水质较差则应增加除垢频率。若未按时清理水垢, 可能会导致蒸炖锅无法正常工作。

发热盘如出现斑点, 此为水垢, 属于正常现象, 用百洁布轻轻擦洗即可清洗干净。若情况较为严重, 可采用以下方式进行除垢。

蒸炖锅除垢小贴士

使用北鼎除垢片:

- 在水箱中加入500ml清水和5克除垢片并静置15分钟;
- 启动“蒸”模式, 烹煮时间设置为1分钟。待自动断电后, 静置5-10分钟;
- 将水倒掉后, 用清水清洗5-6次, 必要时可重复。

使用白醋:

- 水箱中加入100ML白醋;
- 水箱中加入500ML清水;
- 启动“蒸”模式, 烹煮时间设置为1分钟。待自动断电后, 静置5-10分钟;
- 将水倒掉后, 用清水清洗5-6次, 必要时可重复。

简单故障处理

故障现象	原因分析	故障排除
安装后, 无提示声音且按键灯不亮	未接通电源	检查插头是否正确插入插座上, 插座如有开关, 请确认开关为是否打开
	蒸炖锅与电源线没有连接到位	为蒸炖锅接上电源线时, 请确认已连接到位
	蒸炖锅故障	建议联系北鼎的客户服务中心或者送服务点维修
机器加热10秒后停止工作, 短鸣5声后自动停止 (显示E1)	机器内水温高温提示	一般此情况会出现在酸奶等功能, 表示锅内水温高于程序设定的温度, 请加入冷水再继续工作
蒸炖锅黑屏, 通过操作唤醒后, 屏幕显示E2	干烧保护	冷却蒸锅后, 拔出电源再接通, 在水箱内没水的情况下观察屏幕是否有缺水提示。如有缺水提示, 请加满水继续使用即可; 如无缺水提示, 请见下一项
水箱中没水但是没有缺水提示	水位检测故障	擦干水箱之后, 观察是否有缺水提示。有缺水提示则可继续正常使用; 没有缺水提示则建议联系北鼎的客户服务中心或者送服务点维修
	蒸炖锅故障	建议联系北鼎的客户服务中心或者送服务点维修
水有异味	未使用过的新蒸炖锅	新蒸炖锅使用前建议煮几次水倒掉, 如果状况持续发生, 将水注满至最高水位, 并加两茶匙的苏打, 煮沸后倒掉, 再清洗蒸炖锅。

显示屏故障代码对应表

显示屏代码	故障原因	解决措施
E1	超温警告	使用低于目标温度的纯净水
E2	干烧	参考上表中的处理方法
E3	感温零件故障	建议联系北鼎的客户服务中心或者送服务点维修
E4	高原警告	建议按P21进行沸点检测程序,如检测后仍然反复出现此报警信号,建议联系北鼎的客户服务中心或者送服务点维修
E5	功率切换故障	建议联系北鼎的客户服务中心或者送服务点维修
H1	误入沸点检测程序	断开电源后重新接通即可
H2	误入沸点恢复程序	断开电源后重新接通即可

保修和服务说明

如果产品有明细损坏,请您参考保修条件填好资料,将产品退回北鼎授权的售后服务中心,或者购买的平台;

■ 保修仅限生产缺陷及参照说明书正确使用造成的损坏。因使用不当或其他非产品本身质量问题造成的损坏,将收取维修费用。

以下情况恕不免费维修

- 无三包凭证及有效发票
 - 未按说明书的要求操作引发的故障
- A. 消费者使用、保管、维护不当造成的损坏。
- B. 非本公司指定维修部自行装拆修理而造成的损坏。
- C. 因不可抗力造成的损坏。

为了客户的利益,北鼎保留对产品特性及组件做出修改的权利,以确保产品的正常使用。



保修卡

1. 根据“新三包”规定整机保修期为一年(自开具发票之日起);
2. 发票和保修证书一同作为保修凭证, 发票一经涂改, 保修即失效;
3. 因使用不当或其他非产品本身质量问题造成的损坏, 将收取零件成本及人工费。

顾客姓名 _____ 联系电话 _____ 邮 箱 _____

地 址 _____

产品型号 _____ 购买日期 _____ 经销商 _____

机身号码 _____

日期	原因	维修员