

**BUYDEEM**

K2973

多功能电水壶 (养生壶)

使用说明书

Health-care Beverage Maker  
Instruction Manual



**BUYDEEM**

**深圳市北鼎科技有限公司**

K2973-91-A2

产品如有细微改动, 请以实物为准

**Shenzhen Buydeem Technology Co., Ltd.**

K2973-91-A2

Please in kind prevail in case of minor changes.

Please read this instruction carefully before use and keep it properly.

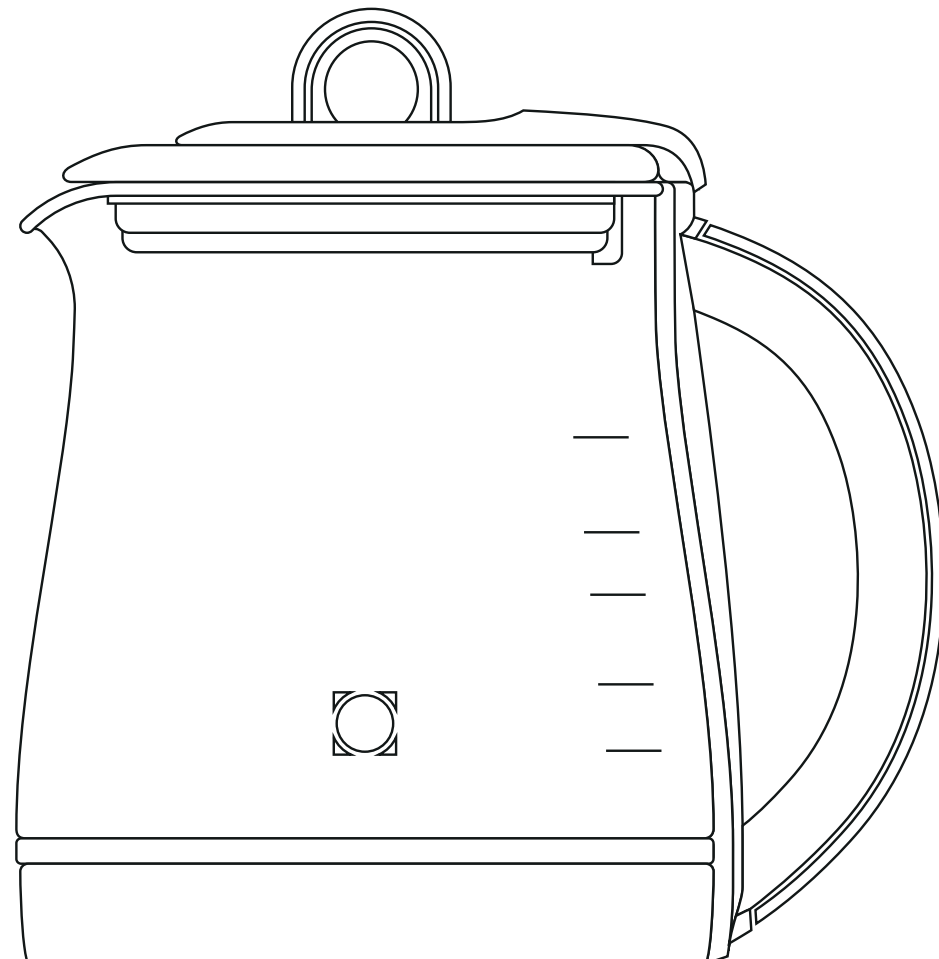

感谢您购买北鼎产品，为了能让您充分享受北鼎全方位的支持，  
使用本产品之前请仔细阅读本说明书及相关图解。

## 目录

## Contents

使用产品	08~18
初次使用	08
使用指引	09
沸点检测	16
特色功能	18
清洁和保养	19
简单故障处理	20
保修和服务	22
保修卡	23
注意事项	02
技术规格	03
认识产品	04~08
产品结构图	04
功能模式介绍	05
玻璃炖盅介绍	07
过滤茶篮介绍	08

### ⚠ 危险

- 切勿在无人看管的情况下运行本产品，以防产品突发情况造成火灾等危险。
- 为防止触电或短路等危险，切勿将养生壶、底座、电源线及插头置于水中或其它任何液体中。

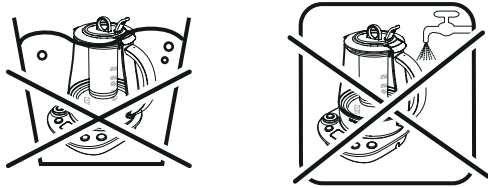

### ⚠ 警告

- 儿童、老年人、肢体或精神能力受限人士及无使用经验人士应在监督和指导下使用产品，并保证其安全。儿童应在监管下接触本产品，以确保他们不会将产品当成玩具玩耍。
- 本产品必须单独使用额定电流10A以上，额定电压120V~60Hz的接地插座，插头需完全插入插座，以防接触不良而导致元件过热烧坏，引发短路或火灾等危险。切勿使用万用插座。
- 请将养生壶和电源线远离高温、明火、潮湿、光滑的台面或锋利的边缘，以防引起器件损坏、故障或火灾。
- 手沾水或赤脚时禁止使用养生壶。

### ⚠ 注意

- 本产品仅设计为家庭使用，厂商仅对生产瑕疵和家用故障进行保修；任何商业用途、不适合用途或未遵照说明操作而造成的后果与故障，厂商均不负任何责任，此等故障损坏均不属于保修范围内。
- 使用前请核对产品规格标贴上显示的电压与主电压是否一致。
- 本产品必须和其配套的底座一起使用，请勿使用其它底座。
- 请始终将养生壶放置在平坦、稳固、耐热的工作台上。
- 使用产品前，请务必确认上盖已正确盖好，以防烫伤。
- 养生壶在工作期间会产生高温和蒸汽，请勿在工作期间揭开壶盖、触碰或移动养生壶、靠近蒸汽出口等高温部分，以防烫伤。
- 请勿将密闭的容器放置在壶内加热，以防引起爆炸的危险。
- 请勿在超过最大水位或低于最低水位的情况下运行养生壶；养生壶内装水或食材过满，可能会引起沸水溅出，养生壶内装水或食材过少，可能会引起干烧或糊底。
- 养生壶要防潮、防冻，请勿将养生壶放进冰箱。

### ⚠ 注意

- 为防止触电或火灾，请保证下列情况下电源是断开的：空壶时、不使用养生壶时、清洁或移动养生壶时、养生壶部件损坏时、当养生壶出现故障时。
- 如果长时间不使用养生壶，建议将养生壶内的水倒掉。
- 如需拔下插头，请手握住插头再拔出，请勿强行拉扯或扭曲电源线，以防电源线损坏，产生漏电危险。
- 请不要让电源线悬挂在桌子或工作台面边缘之外，以防养生壶摔落，或引起绊倒。
- 请不要用非推荐的方法除水垢，推荐方法详见P19。
- 如发现养生壶部件损坏或不能正常工作时，请立即拔掉电源插头，切勿继续使用，也勿自行拆除，请前往北鼎授权的服务中心进行更换或维修。
- 除了按照说明书进行清洁和除垢，其它任何非正常使用操作必须由北鼎授权的服务中心进行。
- 由于未对养生壶进行除垢造成其不能正常使用或完全不能使用的情况，不属于保修范围。
- 因为所有产品均严格按照质量控制程序，其中包括对随机抽检产品的实际使用测试，所以其将对产品的任何使用痕迹作出解释。

### 技术规格

产品名称：多功能电水壶（养生壶）

产品型号：K2973

产品功率：1000W

最大容量：1.5L

电压：120V~60Hz

本产品采用食品接触用材质：

SUS304 (06Cr19Ni10) 及 SUS316L (022Cr17Ni12Mo2) 不锈钢、

德国肖特高硼硅玻璃（可用于烹饪使用）、聚丙烯PP塑料、食品接触用硅胶

## 产品结构图

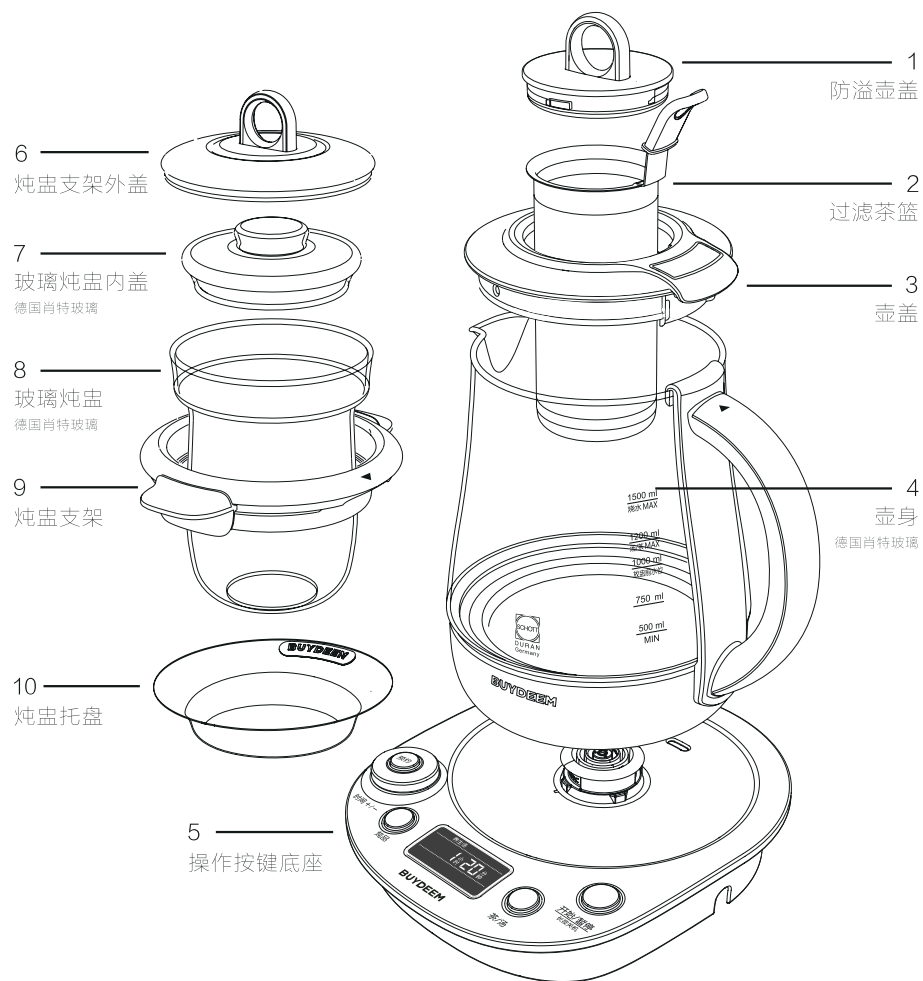

## 按键功能介绍

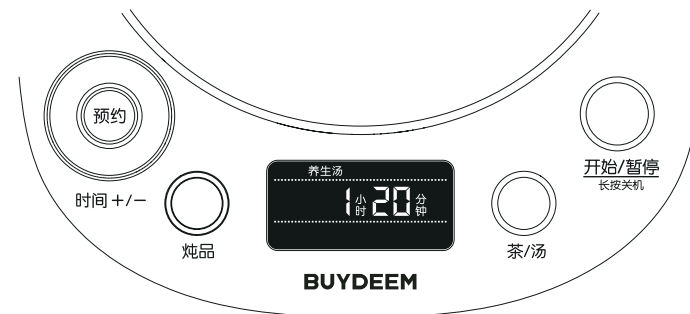

功能类型	功能名称	适煮食材	功能运作方式
基础功能	开始/暂停	/	按下此按键, 养生壶开始/暂停工作。 长按2秒停止工作, 进入待机状态。
	烧水	/	快速烧水至沸腾后停止工作。 注意: 请勿用此功能键加热除水外的汤汁/液体, 否则可能出现溢出现象
煮功能模式	养生汤 (默认60分钟)	银耳、绿豆、薏米等	水烧开后, 按照养生汤模式工作60分钟。 程序结束后, 养生壶自动保温70°C, 2小时。
	灵芝/虫草 (默认30分钟)	灵芝、虫草、参类等	水烧开后, 按照灵芝/虫草模式工作30分钟。 程序结束后, 养生壶自动保温70°C, 2小时。
	花果茶 (默认10分钟)	花草茶、水果茶、 中式熟茶等	水烧开后, 按照花果茶模式工作10分钟。 程序结束后, 养生壶自动保温70°C, 2小时。

功能类型	功能名称	适煮食材	功能运作方式
炖功能模式	粥品 (默认60分钟)	五谷粥、蔬菜粥等	水烧开后,按照粥品模式工作60分钟。 程序结束后,养生壶自动保温70°C,2小时。
	药膳 (默认120分钟)	花胶、骨头汤等	水烧开后,按照药膳模式工作120分钟。 程序结束后,养生壶自动保温70°C,2小时。
	燕窝 (默认25分钟)	燕窝	水烧开后,按照燕窝模式工作25分钟。 注意:为避免燕窝化水,此功能无自动保温。
	酸奶 (默认40°C/10小时)	酸奶	按酸奶模式将壶中的水维持在40°C,保温10小时。 注意:若壶内水温过高,选择“酸奶”功能时,养生壶会短鸣5声后自动停止工作,进入待机状态。 此功能无自动保温。
预约模式	预约	/	按下此按键可进入预约模式,根据设定的时间完成“炖品”或“茶/汤”中的功能。 提示:若处在预约模式,显示屏上的时间表示距离汤水煮好的剩余时间。当倒计时完成时,您即可享用美味。
	时间+/-旋钮	/	此旋钮用于调整烹煮或预约时长。

## 玻璃炖盅介绍

### △注意:

- 请勿在养生壶放入炖盅时进行倒水操作,以防炖盅与支架掉落造成烫伤危险。
- 请勿将玻璃炖盅直接明火加热。
- 请勿将玻璃炖盅放入烤箱或微波炉内加热。
- 炖盅的有效最大容量为500ml(约炖盅高度7成),使用时请勿超出最大容量,以免使用过程中食材溢壶造成烫伤。

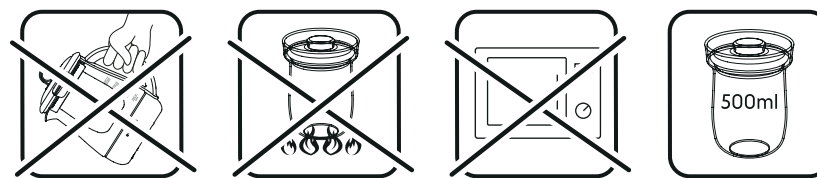

### 1.玻璃炖盅安装:

将炖盅置于支架内,将支架连炖盅一起提起,安装在养生壶上并盖上大盖子。  
注意需对齐支架三角标识与壶身把手三角标识。



### 2.玻璃炖盅拆卸:

提起支架连炖盅一起取出,轻轻放下支架,拿走支架盖子,取出炖盅。

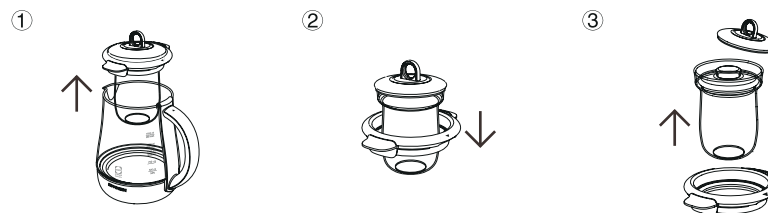

### 过滤茶篮介绍

- 用户可随时通过拧开茶篮盖观测食物烹煮状态,从而选择加料或调味等操作。
- 若烹煮起泡较多的食材,建议打开防溢壶盖,可有效防止溢出情况出现。

#### 1. 过滤茶篮安装:

抓住茶篮提手,将茶篮放入壶盖中空位置,顺时针拧紧防溢壶盖即可。

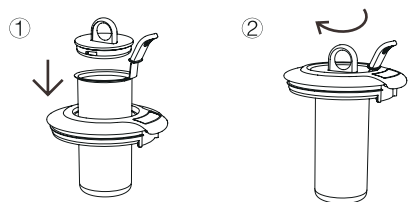

#### 2. 过滤茶篮拆卸:

逆时针拧开防溢壶盖,抓住茶篮提手,提出茶篮。

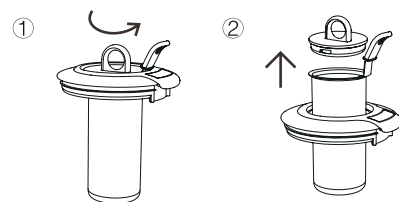

### 炖盅托盘介绍

- 在日常使用养生壶的过程中,不锈钢托盘可暂存炖盅套件和茶篮套件。
- 避免汤汁泼溅,同时保持桌面干净整洁。

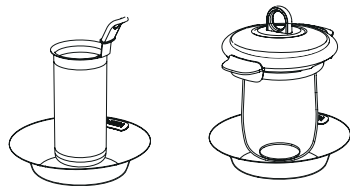

### 初次使用

1. 去除养生壶以外所有包装,标签及附件。在初次使用前,我们建议您做一次沸点检测操作(详见P16)。
2. 前2-3次煮水应倒掉用于清洁,然后用湿布擦拭养生壶部件的外部。

请注意:壶底和底座上的电子连接器不可接触水。

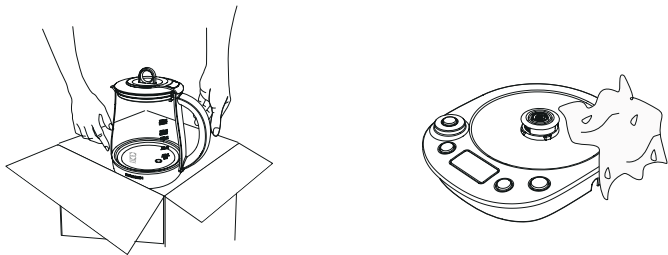

### 使用指引-烹煮

#### 1. 打开壶盖

- 拉紧茶篮盖提手,向上拉即可打开壶盖。



#### 2. 加入食材

- 将食材直接放入壶中。



#### 3. 加入适量的净水

- 当养生壶在底座上时勿加水。
- 切勿加水和食材超过最大水位或低于最小水位。
- 若加水过满,沸腾时可能会溅出水。

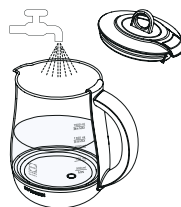

#### 4. 如需使用过滤茶篮

- 如食材较细碎,如花草茶、茶叶等,可使用过滤茶篮。
- 将细碎的食材放入茶篮中,按P8页所示装好茶篮。



## 使用指引-烹煮



### 5. 盖紧壶盖

- 将壶盖按图示位置放在壶身上,轻轻按压使壶盖合紧,用手轻轻提起,若提不起,表示盖子合紧。
- 如盖子装配不到位,倒水时,盖子容易掉下来。

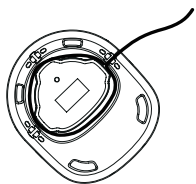

### 6. 调整底座电源线长度

- 通过底座的绕线装置调整电源线的长度。

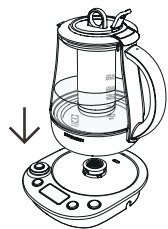

### 7. 将养生壶放在底座上

- 请将壶底及底座面上的水擦干。
- 底座务必放置在平坦、干净的耐热台面上。
- 养生壶必须使用专属的底座。
- 无水时请勿使用。

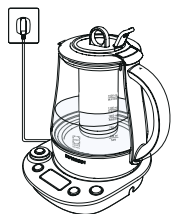

### 8. 插上电源

- 当养生壶通电时,蜂鸣器发出响声,按键灯闪烁后灯灭,表示进入待机状态,可开始选择功能工作。

## 使用指引-炖煮



### 1. 如需使用玻璃炖盅

- 将食物放入炖盅内,加入适量的水。



### 2. 在养生壶里加入适量净水

- 加水至养生壶刻度1000ml(放盅前水位)。
- 当养生壶在底座上时勿加水。



### 3. 安装壶盖

- 将支架连炖盅提起,按P7页所示安装好炖盅。
- 请注意!请确认支架上三角标识对齐壶身把手上的三角标识,否则说明炖盅支架没安装好炖盅。

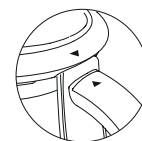

### 4. 调整底座电源线长度

- 通过底座的绕线装置调整电源线的长度。

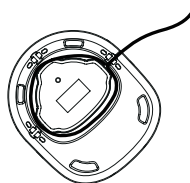

## 使用指引-炖煮

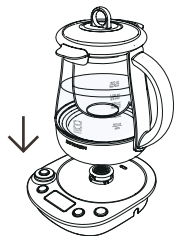

### 5. 将养生壶放在底座上

- 请将壶底及底座面上的水擦干。
- 底座務必放置在平坦、干净的耐热台面上。
- 养生壶必须使用专属的底座。
- 无水时请勿使用。

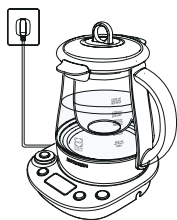

### 6. 插上电源

- 当养生壶通电时，蜂鸣器发出响声，按键灯闪烁后灯灭，表示进入待机状态，可开始选择功能工作。

## 功能模式使用指引

1. 连续按下“炖品”或“茶/汤”选定烹煮功能模式，此时相应“炖品”或“茶/汤”按键常亮，“开始/暂停”按键闪烁。屏幕显示当前功能默认标准时长。

提示：您可以根据自己的口味，旋转“时间+/-”旋钮调整当时功能的工作时长。

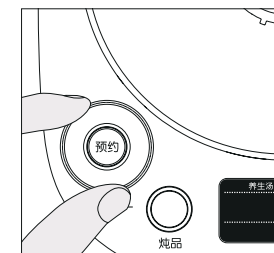
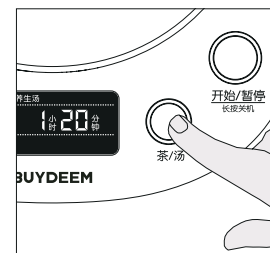

2. 按下“开始/暂停”键，养生壶开始工作。养生壶将快速将壶内水烧至沸腾，此时屏幕显示“———”，右侧进度条开始跳动。提示：“酸奶”功能模式无此阶段。

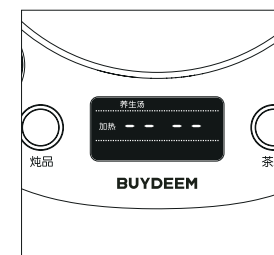
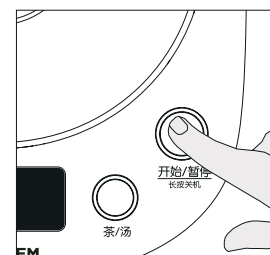

3. 当壶内汤水沸腾后，养生壶自动转入小火烹煮阶段，此时屏幕显示当前功能剩余时间，右侧进度条持续跳动。待剩余时间为0时，表示烹煮完成，转入保温阶段。

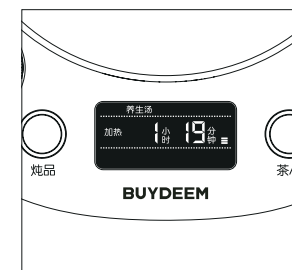



4. 保温阶段时, 相应功能按键呼吸灯闪烁, “开始/暂停”常亮, 屏幕显示“保温”字样及保温剩余时间, 同时进度条持续跳动。待剩余时间为0时, 保温完成, 养生壶转入待机状态。

提示: “烧水”、“燕窝”和“酸奶”功能无自动保温。

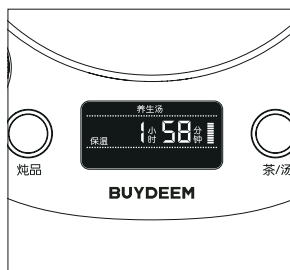

功能名称		最短时长	默认标准时长	最长时长	自动保温
“茶/汤” 按键	烧水	无	无	无	无
	花果茶	5分钟	10分钟	20分钟	70°C/120分钟
	养生汤	30分钟	60分钟	150分钟	70°C/120分钟
	灵芝/虫草	20分钟	30分钟	40分钟	70°C/120分钟
“炖品” 按键	粥品	30分钟	60分钟	120分钟	70°C/120分钟
	药膳	90分钟	120分钟	150分钟	70°C/120分钟
	燕窝	20分钟	25分钟	45分钟	无
	酸奶	8小时	10小时	16小时	无

## 预约功能使用指引

1. 连续按下“炖品”或“茶/汤”选定烹煮功能模式, 此时相应“炖品”或“茶/汤”按键常亮, “开始/暂停”按键闪烁。屏幕显示当前功能默认标准时长。

提示: 您可以根据自己的口味, 旋转“时间+/-”旋钮调整当时功能的工作时长。

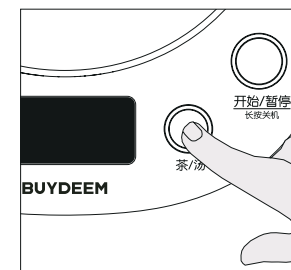

2. 按下“预约”按键, 此时按键灯亮, 屏幕显示“预约”字样, 同时显示养生壶待机时长和烹煮时长的总和; 旋转“时间+/-”旋钮至您所希望的预约时长。

提示: 例如设定预约10小时0分, 则表示10小时后为汤水煮好并开始保温, 可即刻享用。预约途中您可以随意切换功能和更改预约时长。

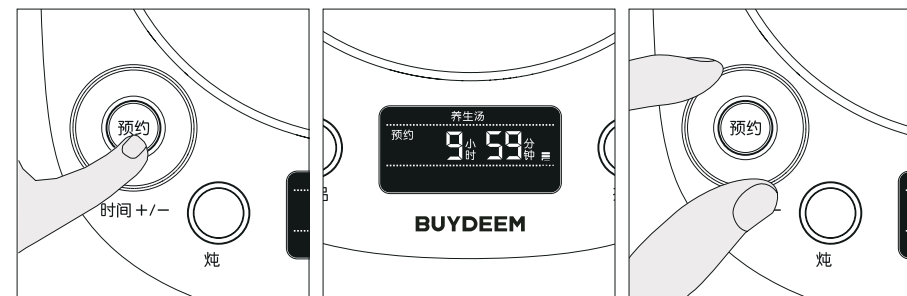

## 沸点检测 / Boiling point

### 沸点检测记忆程序

- 由于在非零海拔地区,水在沸腾时无法达到100°C,这将导致普通养生壶无法正常工作(跳断过慢甚至无法正常跳断)。
- 北鼎建议您在第一次使用时,均进行一次沸点检测操作。检测完成后,芯片将记录精确沸点数据,再次使用无需重复检测。
- 经过沸点检测后,养生壶能更精准地工作(性能比出厂设置时更佳)。
- 若您处于海拔高于250m的城市,请务必进行沸点检测操作后再使用。

### 启动沸点检测

1. 加水至1200ml水位线,水量不足或过多时,会影响检测结果。

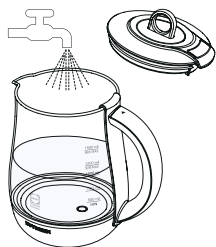

2. 放入线座,先不通电。

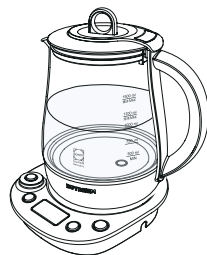

## 沸点检测 / Boiling point

3.同时按住“茶/汤”和“开始/暂停”按键,按稳后再将电源插头插入电源,听到短鸣一声后,屏幕显示“H1”,此时方可松开手指。

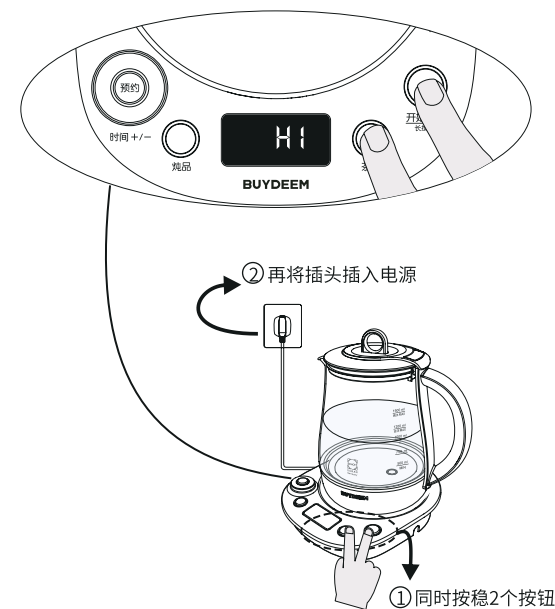

4.“开始/暂停”灯圈闪烁,按一下“开始/暂停”键开始检测。

开始检测后,屏幕继续显示“H1”,同时右侧进度条轮番闪烁。  
检测完成后会长鸣三声,自动结束工作并进入待机状态。

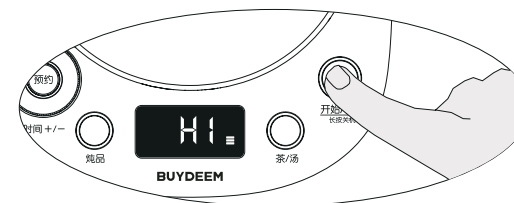

### 壶暂停记忆功能

养生壶按照程序进行工作时,可通过提壶或按“开始/暂停”来使其暂停工作,暂停1个小时内再通过放壶或按“开始/暂停”来开始工作,养生壶将执行暂停前未完成的程序时间,不会重新执行一遍功能程序。

### 避免误操作

养生壶按照所选功能模式进行工作的1分钟内,可任意切换模式;也可通过再按一次“已选定模式按键”来取消工作命令,让机器重新进入待机状态。

为了避免误操作,养生壶开始工作1分钟后,不能随意切换功能。若需要切换功能,需先按“开始/暂停”按键,“开始/暂停”按键闪烁,再选择需要切换的程序。

### 冷水保护

养生壶工作时,如在烹煮中途加入冷水,养生壶会自动重新将水烧开后再执行未完成的程序,无需担心生冷隐患。

### 清洁和保养

#### 养生壶的清洗

1. 拔下电源插头。
2. 待水壶冷却后,用湿海绵清洗养生壶内部。  
注意:切勿将养生壶、底座、电源线或插头浸泡水中(壶底及底座上的电子连接器不可接触水)。
3. 每次使用后,为避免食物变质,请及时清洗。

#### 除水垢

养生壶需定期除水垢,至少每月一次,如水质较差则应增加次数。

发热盘如出现斑点,此为水垢,属于正常现象,用百洁布轻轻擦洗即可清洗干净。若情况较为严重,可采用以下方式进行除垢。

#### 养生壶除垢小贴士

使用白醋:

- 往养生壶内加入100ml白醋。
- 往养生壶内加水至500ml刻度线。
- 启动“烧水”模式。
- 程序结束后,静置1小时,然后用百洁布将壶底擦净即可。

使用柠檬酸:

- 往养生壶内加入500ml清水。
- 加入10g柠檬酸。
- 启动“烧水”模式。
- 待自动断电后,静置5-10分钟。(若水垢较多,可延长静置时间)
- 最后将壶内水倒掉,用百洁布将壶底擦净即可。

## 简单故障处理 / Simple Troubleshooting

### 简单故障处理

故障现象	原因分析	故障排除
安装后,无提示声音且按键灯不亮	未接通电源	检查插座是否已插好
	煲身与底座没有连接到位	煲身放上线座后,可旋转或调整位置,确认已连接到位
	线座故障	建议送服务点维修
提示音持续响	干烧保护(一般按键灯全亮)	冷却数分钟后,再倒入冷水继续使用
	NTC异常	建议送服务点维修
壶加热10秒后停止工作,短鸣3声后自动关机	壶内水温高温提示	一般此情况会出现在保温、酸奶、温奶等功能,壶内水温高于程序设定的温度,加入冷水再继续工作。
水有异味	未使用过的新养生壶	新养生壶使用前建议煮几次水倒掉,如果状况持续发生,将水注满至最高水位,并加两茶匙的苏打,煮沸后倒掉,再清洗养生壶。

## 环保清单 / List of Environmental Protection

### 环保清单

产品中有毒有害物质或元素的名称与含量

部件名称	有害物质					
	铅(Pb)	汞(Hg)	镉(Cd)	六价铬(Cr(VI))	多溴联苯(PBB)	多溴二苯醚(PBDE)
壶盖组件	○	○	○	○	○	○
壶身组件	○	○	○	○	○	○
底座组件	○	○	○	○	○	○
发热盘组件	×	○	×	○	○	○
电路板组件	×	○	○	○	×	×
电源线	×	○	○	○	○	×

○:表示该有害物质在该部件所有均质材料中的含量均在GB/T 26572规定的限量要求之下。

×:表示该有毒有害物质至少在该部件的某一均质材料中的含量超出GB/T 26572规定的限量要求。

	<p><b>环保使用期间10年:</b>表示本产品中含有的有害物质不会发生外泄或突变,用户在产品说明书所述情况下正常使用本产品不会对环境造成严重污染或对其人身、财产造成严重损害的期限。</p> <p><b>箭头循环标志:</b>表示本产品可回收利用。超过使用期限或经过维修无法正常工作后,不应被随意丢弃,请交由正规回收渠道以及有废弃电气电子产品处理资格的企业处理,正确的处理方法请查阅国家或当地有关旧电器电子产品的处理规定。</p>
--	--

以上标识均依据中国有害物质限制使用管理办法及其配套标准SJ/T 11364要求执行。

产品长期使用不会对人体产生危害,请放心使用

# 保修和服务 / Warranty & Service

## 保修和服务说明

如果产品有明细损坏, 请您参看保修条件填好资料, 将产品退回北鼎授权的售后服务中心修理, 产品型号及序列号可见于产品底部。

- 保修仅限生产缺陷及参照说明书正确使用造成的损坏。
- 如果电源线损坏, 为避免危险, 必须由生产商、售后服务中心的专业人员进行维修或更换。
- 已过保修期限的顾客, 如需购买产品零配件, 可联系 [service@pandabrand.com](mailto:service@pandabrand.com)

以下情况恕不免费维修

- 无三包凭证及有效发票
  - 未按说明书的要求操作引发的故障
- A. 消费者使用、保管、维护不当造成的损坏。  
B. 非本公司指定维修部自行装拆修理而造成的损坏。  
C. 因不可抗力造成的损坏。

为了客户的利益, 北鼎保留对产品特性及组件做出修改的权利, 以确保产品的正常使用。

如果您需要更多的服务和信息, 或有任何疑问, 请访问北鼎网站 [www.buydeem.com](http://www.buydeem.com), 或致电 [service@pandabrand.com](mailto:service@pandabrand.com), 或与当地经销商联系。您也可以剪下保修卡填写资料, 将产品寄回本公司, 由本公司专业人员为您解决。



## 保修卡

1. 根据“新三包”规定整机保修期为一年(自开具发票之日起)
2. 发票和保修证书一同作为保修凭证, 发票一经涂改, 保修即失效。
3. 因使用不当或其他非产品本身质量问题造成的损坏, 将收取零件成本及人工费。

顾客姓名 \_\_\_\_\_ 联系电话 \_\_\_\_\_ 邮 箱 \_\_\_\_\_  
地 址 \_\_\_\_\_  
产品型号 \_\_\_\_\_ 购买日期 \_\_\_\_\_ 经销商 \_\_\_\_\_  
机身号码 \_\_\_\_\_

日期	原因	维修员

Pandabrand Inc.  
Email: [service@pandabrand.com](mailto:service@pandabrand.com)

**Thank you for purchasing BUYDEEM products, please carefully read the instruction manual and related diagrams to fully enjoy our supporting.**

## **Contents**

<b>Notice</b> .....	26
<b>Technical specification</b> .....	27
<b>Understanding Product</b> .....	28~32
Product structure drawing .....	28
Function introduction .....	29
Component introduction .....	31
Tea Basket Introduction .....	32

<b>Usage of product</b> .....	32~42
Initial use .....	32
Use Guidelines .....	33
Boiling Point Test .....	40
Features .....	42
<b>Cleaning and Maintenance</b> .....	43
<b>Simple troubleshooting</b> .....	44
<b>Warranty and Service</b> .....	46
<b>Warranty card</b> .....	47

## Notice

---

### IMPORTANT SAFEGUARDS

When using electrical appliances, basic safety precautions should always be followed, including the following:

- Read all Instructions.
- Do not touch hot surfaces. Use handles or knobs.
- To protect against fire, electric shock and injury to persons do not immerse cord, plugs, or Base and Body in water or other liquid.
- Close supervision is necessary when any appliance is used by or near children.
- Unplug from outlet when not in use and before cleaning. Allow to cool before putting on or taking off parts, and before cleaning the appliance.
- Do not operate any appliance with a damaged cord or plug or after the appliance malfunctions, or has been damaged in any manner. Return appliance to the nearest authorized service facility for examination, repair or adjustment.
- The use of accessory attachments not recommended by the appliance manufacturer may result in fire, electric shock or injury to persons.
- Do not use outdoors .
- Do not let cord hang over edge of table or counter, or touch hot surfaces.
- Do not place on or near a hot gas or electric burner, or in a heated oven.
- Always attach plug to appliance first, then plug cord into the wall outlet. To disconnect, turn any control to "off," then remove plug from wall outlet.
- Do not use appliance for other than intended use.
- Scalding may occur if the lid is removed during the brewing cycles.

### SAVE THESE INSTRUCTION

When using electrical appliances, basic safety precautions should always be followed, including the following:

- A short power-supply cord (or detachable power-supply cord) is provided to reduce risks resulting from becoming entangled in or tripping over a longer cord.
- Longer detachable power-supply cords or extension cords are available and may be used if care is exercised in their use.
- If a long detachable power-supply cord or extension cord is used:
  - 1.The marked electrical rating of the detachable power-supply cord or extension cord should be at least as great as the electrical rating of the appliance;
  - 2.If the appliance is of the grounded type, the extension cord should be a grounding-type 3-wire cord;
  - 3.The longer cord should be arranged so that it will not drape over the counter top or table top where it can be pulled on by children or tripped over.

### Dangerous

- Do not use this product without supervision, otherwise there may be fire and other hazards caused.
- In order to prevent electric shock or short circuit, do not put the product, base, power cord and plug in water or any other liquid.

### Warning

- This product must use the earthing socket with rated current of more than 10A and rated voltage of 120V-60Hz separately. The plug shall be fully inserted into the socket to avoid the risk of overheating and burning of the component due to poor contact, which may lead to dangers like short circuit or fire, etc.
- Do not use all-purpose socket.
- Keep the beverage maker and power cord away from high temperature, open flame, damp, smooth surface or sharp edges to prevent device damage, malfunction or fire.
- Prohibit the use when hands with water or bare feet.

## Notice

---

### Notice

- This product is only designed for home use. The manufacturer only guarantees the production defects and household failures, not be liable for any consequences or failures arising from any commercial use, inappropriateness, or failure to comply with the instructions and such malfunction and damage are not covered by the warranty.
- Please check whether the voltage indicated in the product specifications label is the same as the main voltage before used.
- This product must be used with its matched base. Please do not use any other base.
- Please keep the health kettle on a flat, stable and heat resistant worktable.
- Before using the product, please make sure that the upper cover is properly covered to prevent burns.
- Do not put the sealed container in the kettle to heat, otherwise there may be risk of explosion.
- Do not operate beverage maker beyond the maximum water level or below the minimum water level; if the water or food in the health kettle is too full, boiling water may splash out. If the water or food in the health kettle is too little, it may cause dry burning and paste bottom.
- The product should be moisture-proof and frost-proof. Do not put it in the refrigerator.
- To prevent electrical shock or fire, make sure the power supply is disconnected under the following circumstances: When the beverage maker is empty, not be used, be cleaned or moved, or when the components are damaged and breaks down.
- It is recommended to drain the water from the kettle if not use for a long time.
- If you need to pull the plug, please hold the plug and pull it out by hand. Do not force or twist the power cord, to prevent the power cord damage, and eliminate the electrical leakage.
- Please don't hang the power cord outside the desk or the edge of the work table to prevent the water dispenser from falling or a trip.
- Please don't use non recommended methods for descaling. Recommended methods please refer to P23.
- Please unplug the power plug immediately if your components of product has been damaged or can't be used properly, do not disassemble and go to the authorized service center of Buydeem for replacement or maintenance.
- In addition to cleaning and descaling in accordance with the instructions, any other abnormal operation shall be performed by the authorized service centre of Buydeem.
- Theun-normal use or complete out of use due to non-descaling is beyond guarantee range.
- It will explain any traces of the product use because all products are strictly in accordance with the quality control procedures, including the actual use testing of the products inspected randomly.

### Technical specifications

Product name: Health-care Beverage Maker    Product model: K2973    Rated power: 1000 W    Rated voltage: 120V ~ 60Hz    Maximum capacity: 1.5 L

German Schott glass SUS304 (06Cr19Ni10) and SUS316L (022Cr17Ni12Mo2) stainless steel, Polypropylene PP plastic, silicone for food contact is adopted.

# Understanding Product

## Product Structure Drawing

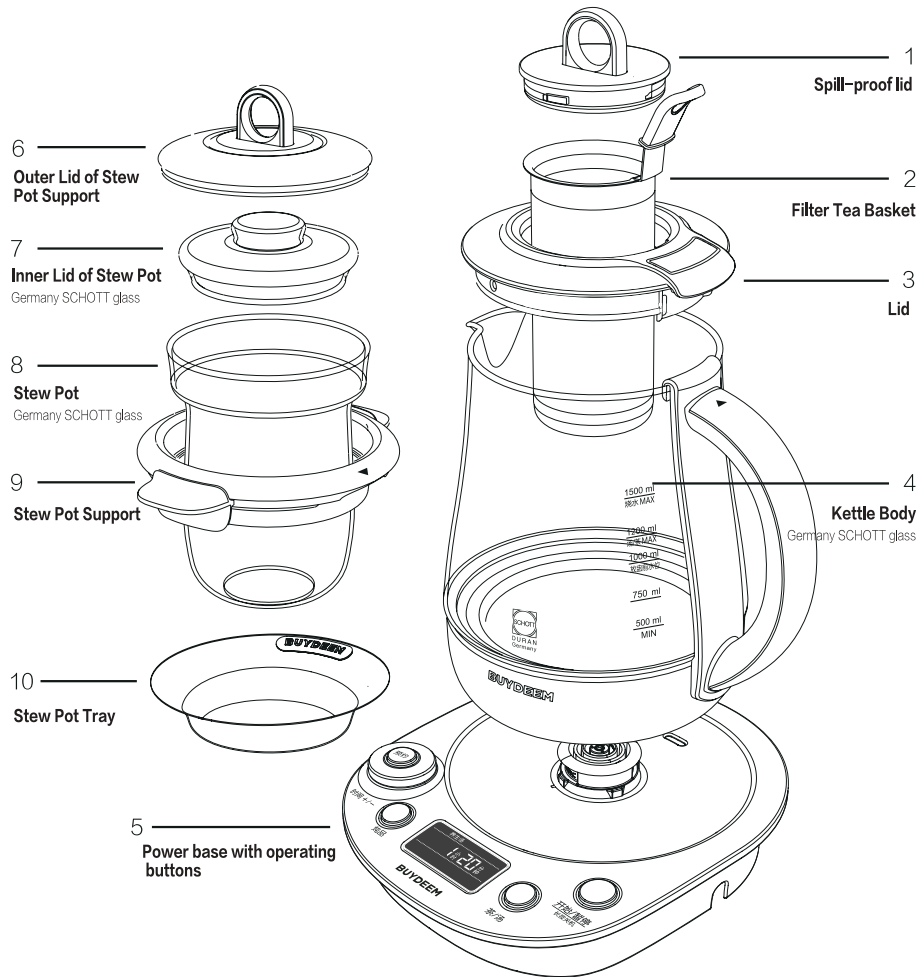

# Understanding Product

## Product Structure Drawing

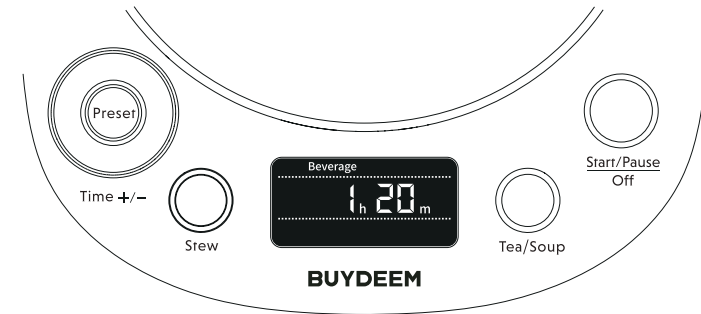

Function Type	Function Name	Ingredients for Cooking	Function Mode
Basic Functions	Start / Pause	/	Press the button, product starts/pause the operation. Long press for 2 seconds to stop the operation and enter into standby state.
	Boil	/	Bring the water to a boil quickly and stop working. Note: do not use this function button to heat soup/liquid except water. Otherwise, overflow may occur
Boiling Function Mode	Soup (60 min)	Tremella,s, Green Bean, Pearl Barley, etc.	When boiling, follow Beverage mode for 60 minutes. Once program is ended, product will enter into automatic heat-preservation mode (70° C) for 2 hours.
	Herbal (30 min)	Ganoderma Lucidum, Worm Grass, Ginseng, etc.	After boiling, follow the Herbal mode for 30 min. Once program is ended, product will enter into automatic heat-preservation mode (70° C) for 2 hours.
	Fruit Tea (10 min)	Flower Tea, Fruit Tea, Chinese Cooked Tea, etc.	After boiling, follow Fruit Tea mode for 30 min. Once program is ended, product will enter into automatic heat-preservation mode (70° C) for 2 hours.



# Understanding Product

Function Type	Function name	Ingredients for Cooking	Function Mode
Stew Function Mode	Congee (60min)	Cereal congee, Vegetable Porridge, etc.	After boiling, follow congee mode for 60 min. Once program is ended, product will enter into automatic heat-preservation mode (70° C) for 2 hours.
	Soup (120min)	Fish Glue, Bone Soup, etc.	After boiling, follow the Soup mode for 120 min. Once program is ended, product will enter into automatic heat-preservation mode (70° C) for 2 hours.
	Bird's Nest (25min)	Bird's Nest	After boiling, follow Bird's Nest mode for 25 min. Note: Avoid bird's nest turns to water, no heat-preservation function under this mode.
	Yogurt (40° C/10 hours)	Yogurt	Follow Yogurt model that keep water in pot at 40° C temperature for 10 hours Note: If water temperature in pot is too high, if select Yogurt mode, the product will stop working automatically after short sound for 5 times and then enter into standby mode. no heat-preservation function for Yogurt mode.
Preset Mode	preset	/	Enter the Preset mode by pressing button, based on set time, complete the function of Stew or Tea/Soup. Tip: If in preset mode, the time on LCD display indicates the remaining time. Until the soup is cooked well. When the countdown is ended, you can enjoy the delicious food.
	Time+/-	/	This knob is used to adjust the cooking or preset time.

# Understanding Product

## Stew pot Introduction

### ⚠ Note:

- Do not pour water when stew pot is put on the product, in case stew pot and the holder fall off, cause the danger of scald.
- Do not heat stew pot directly over open flame.
- Do not heat stew pot in oven or microwave.
- The maximum effective capacity of stew pot is 500ml (about 70% of the stew pot height). Please do not exceed maximum capacity to avoid scalding caused by the overflow of ingredients during use.

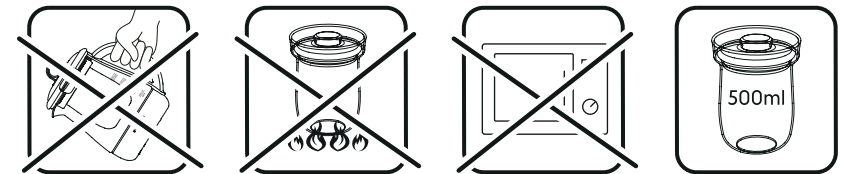

### 1. Stew Pot Installation:

- Place stew pot in the holder, lift the holder together with the stew pot, install it on product body and cover it with lid. Note that align the bracket triangle mark with handle triangle mark.



### 2. Stew Pot Disassembly

- Lift the stew pot holder and stew pot together, gently put down the support, remove the lid and take out stew pot.

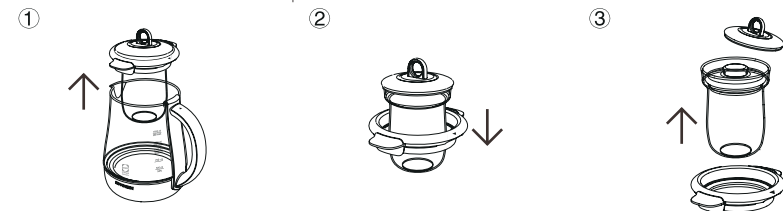

# Understanding Product

## Tea Basket Introduction

- Users can open the tea basket lid at any time to observe the food cooking state, so as to select feeding or seasoning operations.
- If cook more bubbly ingredients, suggest to open the spill-proof lid, which can effectively prevent spillage.

### 1. Tea Basket Installation:

Hold the tea basket handle, put tea basket into the hollow position of lid, and tighten the spill-proof lid clockwise.

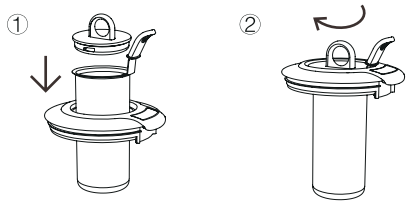

### 2. Tea Basket Disassembly:

Unscrew the spill-proof lid counterclockwise, hold the tea basket handle, and bring tea basket out.

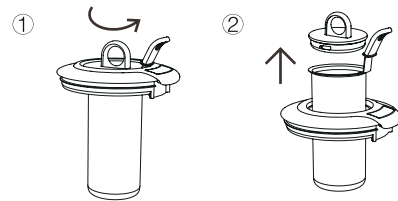

## Stew Pot Tray Introduction

- In daily use, stainless steel tray can temporarily store stew pot and tea basket.
- Avoid splashing, keep the table clean and tidy.

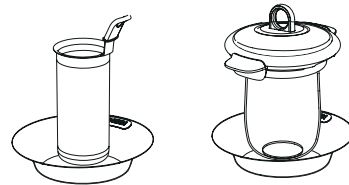

## Initial Use

- Remove all packages and labels and appendix C. Before 1st use, suggest to do a boiling point test (see P40 for details).
  - The first 2 to 3 times of boiled water shall be poured out for cleaning and then wipe the outside parts by a wet cloth.
- Note: The electronic connector on power base and pot bottom shall not contact water.

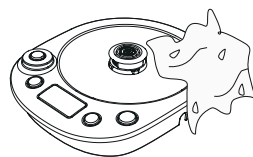
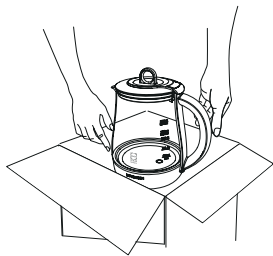

# Using Product

## Use Guidance—Cooking

### 1. Open the lid

- Tighten the tea basket handle, then pull up to open the lid.



### 2. Add the ingredients

- Put the ingredients directly into the pot.



### 3. Add appropriate amount of water.

- While the pot is on the base, do not try to add water.
- Do not add water or ingredients exceed the maximum water scale or lower than the minimum water scale.
- If add too much water, there may be water splashed while boiling.



### 4. Use tea basket as needed

- If the ingredients, such as herb tea, ordinary tea, etc., are in small, broken bits, the tea basket may be used.
- Put the small, broken ingredients into tea basket, and then install properly the filter as shown in P8.



# Using Product

## Use Guidance—Cooking



### 5. Close the lid

- Place the lid on kettle body as shown, press lightly to close the lid and gently lift it with your hands. If it doesn't fit, it means the lid is tight.
- If the lid assemble is not in place, it will fall easily when pouring water.

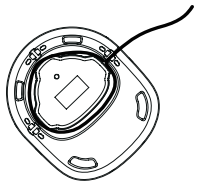

### 6. Adjust the length of power cord.

- Adjust the length of power cord through the winding device of power base.

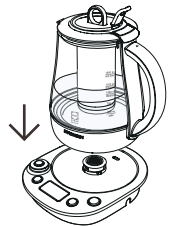

### 7. Put the kettle on power base.

- Please dry the water at the bottom of kettle body and base.
- The base must be placed on a flat, clean, heat-resistant table.
- Exclusive power must be used with the body of beverage maker.
- Do not use if no water in the kettle.

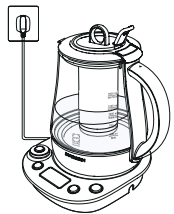

### 8. Plug in power

- When product is energized, the buzzer makes a noise, the button light flashes and turns off later, indicating that the device is in standby mode, and the function can be started.

# Using Product

## Use Guidance – Stewing



### 1. If use glass stew pot

- Put ingredients into stew pot, add appropriate amount of water.



### 2. Add appropriate amount of water into Beverage maker.

- Add water to 1000ml (water level before placing stew pot)
- Do not add water when kettle pot is placed on power base.



### 3. Lid Installation

- Lift the holder with stew pot, install as shown on page P7
- Please note! Please make sure the triangle mark on the holder is aligned with triangle mark on handle, otherwise the holder is not properly installed.

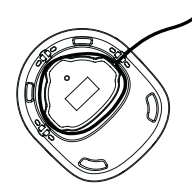
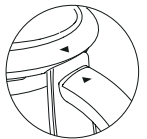

### 4. Adjust the length of base power cord

- Adjust the length of the power cord through base winding device.

# Using Product

## Use Guideline – Stew

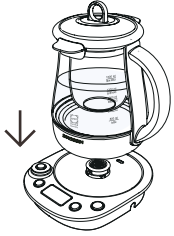

### 5. Put the kettle on power base.

- Please dry the water at the bottom of kettle body and base.
- The base must be placed on a flat, clean, heat-resistant table.
- Exclusive power base must be used with the body of beverage maker.
- Do not use if no water in the kettle.

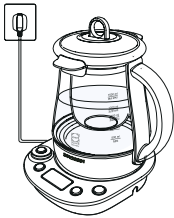

### 6. plug in power

- When product is plug on, the buzzer makes a noise, the button light flashes and turns off later, indicating that the device is in standby mode, and the function can be started.

# Using Product

## Use Guideline for Function Mode

1. Continuously press "Stew" or "Tea/Soup" to select the cooking function mode, and the corresponding "Stew" or "Tea/Soup" button will always light up, "Start/Pause" button will flash. The screen displays the default length of the current function.

Prompt: You can rotate the "time+/-" knob to adjust the working time of the function according to your own taste.

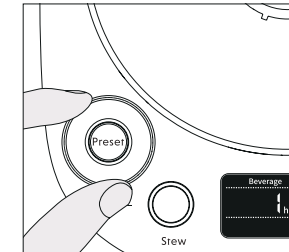
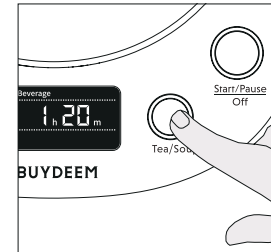

2. Press the "Start/Pause" button to start. The product will quickly boil water in the pot, and the screen will show "–", the right progress bar starts to beat. Prompt: "Yogurt" function mode has no such stage.

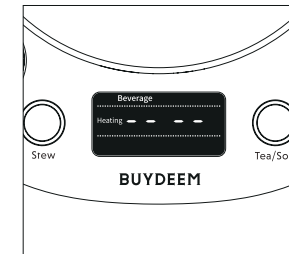
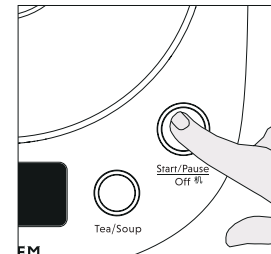

3. After boiling, the product will automatically turn to the low-heat cooking stage. At the same time, the screen will display the remaining time for current function, and the progress bar on the right will continue to beat. When the remaining time is 0, it means the cooking is completed and keep warm automatically.

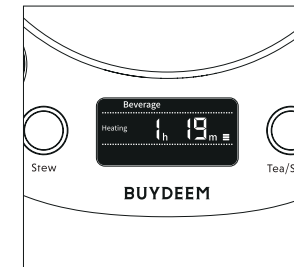

# Using Product

4. During keep warm stage, the corresponding function key breathing light flashes, "Start/Pause" is always on, the screen displays the word "keep warm" and the remaining time, and the progress bar continues to beat. When the remaining time is 0, the insulation is completed, and product turns to standby state.  
 Prompt: There is no automatic keep warm function in "Boiling", "Bird's Nest" and "Yogurt" function.

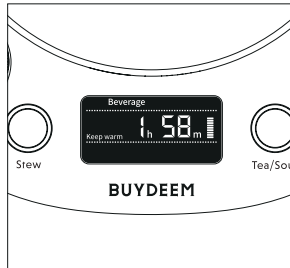

Function Name		Shortest Time	Standard Time In	Longest time	Automatic Heat-preserva
"Tea/Soup" Button	Boil	N/A	N/A	N/A	N/A
	Flower tea	5min	10 min	20min	70°C/120min
	Beverage	30 min	60 min	150min	70° C /120min
	Herbal	20 min	30 min	40min	70° C /120min
"Stew" Button	Congee	30 min	60 min	120min	70° C /120min
	Soup	90 min	120 min	150min	70° C/120min
	Bird's Nest	20 min	25 min	45min	N/A
	Yogurt	8 hours	10 hours	16hours	N/A

# Using Product

## Use Guideline for Preset Function

1. Continuously press "Stew" or "Tea/Soup" to select cooking function mode, the corresponding "Stew" or "Tea/Soup" button will always light up, and the "Start/Pause" button will flash. The screen displays the default length of the current function.  
 Prompt: You can turn the "time+/-" knob to adjust the working time of the function according to your own taste.

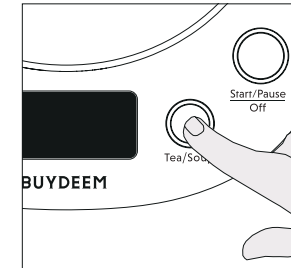

2. Press the "preset" button, the light will be on, the screen will display "preset", and the total standby time and cooking time will be displayed; Turn the "Time +/-" knob to select the desired preset time.  
 Prompt: For example, if you make a reservation for 10 hours, it means that the soup will be cooked well after 10 hours and start to keep warm. Then you can enjoy it immediately. You can switch functions and change the time during preset process.

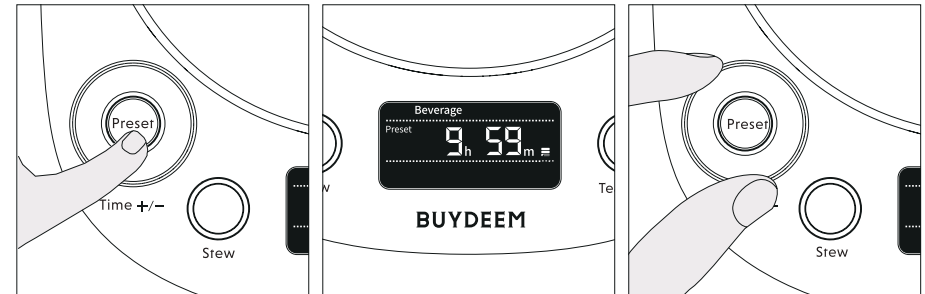

# Boiling Point Test

## Memory Program of Boiling Point Test

- Because in the non-zero altitude, no boiled water can reach 100 ° C, the kettle is unable to work normally (too slow jump-off and even unable to jump off normally).
- BUYDEEM suggest to perform a boiling point test upon the first time you use. After the test is completed, the chip will record the accurate boiling point data, no need for repeated test when use again.
- After completing the boiling point test, the product can work more accurately (better performance than factory Settings).
- If you are in a city above 250m altitude, be sure to do the boiling point test before use.

## Initiate Boiling Point Test

1. Add water to 1200ml; insufficient or excessive water will affect the test results.

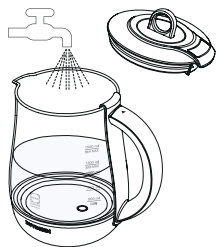

2. Put on power base without power-on.

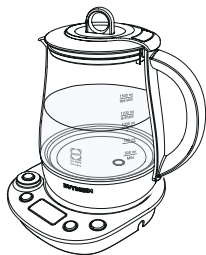

# Boiling Point test

3. Press "Tea/Soup" and "Start/Pause" buttons at the same time, and then plug in the power after the press is stable. After hearing a short sound, the screen will display "H1", and the finger can be released at this time.

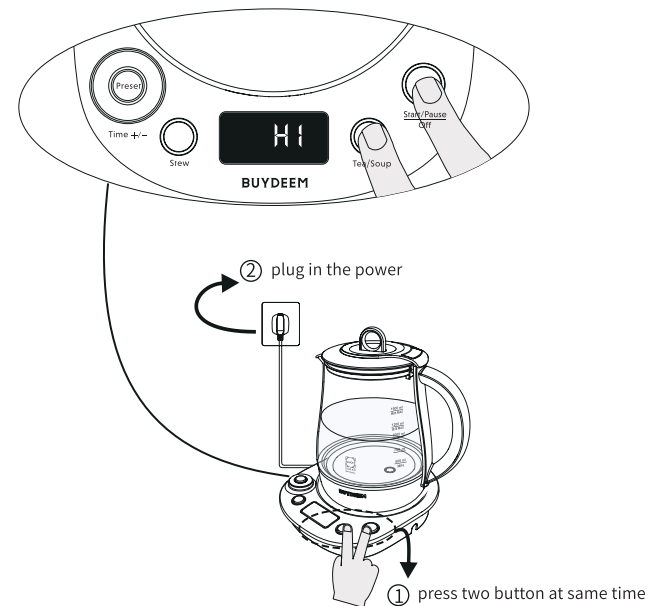

4. The "Start/Pause" light circle flashes. Press the "Start/Pause" button to start the test. After the test starts, the screen continues to display "H1", while the right progress bar flashes in turn. After completion of the test, it will give a long sound for three times and automatically end the work and enter into the standby state.

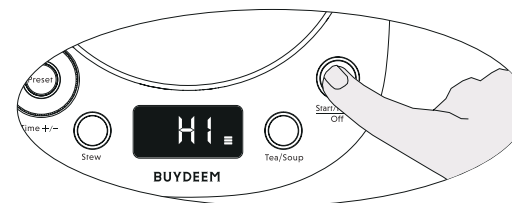

# Features

---

## Memory Pause Function

When product works according to the program, it can be paused by lifting the pot or pressing "Start/Pause", then start the work by putting pot back or pressing "Start/Pause" within 1 hour. The product will continue to execute the program not completed before pause, instead of executing the whole functional program.

## Avoid Mis-operation

When product working, if cold water is added during cooking process, the product will re-boil the water automatically and then execute the unfinished process, no need to worry the danger of cold issues.

In order to avoid mis-operation, the product could not be switched freely after working for 1 minute. To switch functions, please press "Start/Pause" button, "Start/Pause" button flashes and then select the program to switch.

## Cold Water Protection

The product can be switched to any mode within 1 minute according to the selected functional mode. You can also cancel by pressing the "Selected Mode Button" again to put the machine back into standby mode.

### 1. Open the lid

- Tighten the tea basket handle, then pull up to open the lid.

# Cleaning and Maintenance

---

## Cleaning and Maintenance

### Product Cleaning

1. Unplug the power plug.
2. After the pot is cooled, clean the pot inside with a wet sponge.  
Note: Do not immerse kettle pot, pot base, power cord or plug in water (the electrical connector on the bottom and base of pot is not allowed to contact with water).
3. After each use, avoid food deterioration, please wash in time.

## Scaling off

The product should be descaled regularly at least once a month. If water is poor, the frequency should be increased.

If any spot appears on heating plate, which called scale, it is a normal phenomenon, use soft scouring pad to gently clean it. If the situation is serious, the following methods can be used for scale removal.

## Tips for Cleaning Scaling

### 1. Use White Vinegar

- Add 100ml white vinegar to the pot.
- Add water to 500ml.
- Start "boil" function.
- After the program is over, let it stand for 1 hour, then wipe the pot bottom with a scouring pad.

### 2. Use Citric Acid

- Add 500ml of clean water to the pot.
- Add 10g of citric acid.
- Start "boil" function.
- After the power is turned off automatically, let it stand for 5-10 minutes (If there is more scale, you can extend the standing time).
- Pour out the water and clean the pot bottom with a scouring pad.

## Troubleshooting

### Troubleshooting

Troubles	Cause Analysis	Troubleshooting
After installation, there is no prompt sound and the button light is not on	The power is not connected	Check if the socket is plugged in place
	The pot body is not connected with power base in place	After placing the pot body in power base, rotate or adjust the position to confirm the connection is done properly
	Line power base fault	Suggest to send it to the service point for maintenance
The prompt continues to sound	Dry Burning-resistant Protection (All button lights are on)	After cooling for several minutes, pour cold water to proceed
	NTC is abnormal	Suggest to send it to the service point for maintenance
After 10 seconds, the machine stop working. After 3 times for short sound, it will be shut down automatically	High temperature of water prompt inside the pot	In general, this situation may appear in keep warm, yogurt, milk warming mode, the water temperature in pot is higher than configured program, add cold water to proceed.
The water is smelly	New unused product	Suggest to boil water several times before using and pour out. If the situation continues, fill in water to the highest level and add two teaspoons of soda, boil and pour it out, then wash again.

## List of Environmental Protection

### List of Environmental Protection

#### Name and Contents of Toxic or Harmful Substances or Elements in the Product

Part Name	Harmful Substance					
	Lead (Pb)	Lead (Pb)	Cadmium (cd)	Hexavalent Chromiu	Polybrominated biphenyl(PBB)	Polybrominated biphenyl ethers (PBDE)
Pot Lid	○	○	○	○	○	○
Pot	○	○	○	○	○	○
Pot	○	○	○	○	○	○
Heatin	×	○	×	○	○	○
Circuit	×	○	○	○	×	×
Power	×	○	○	○	○	×

○: It means that the contents of the harmful substances in all homogeneous materials of the component are below the limit specified.

×: It indicates that the contents of the toxic and hazardous substances in at least one homogeneous material of the component exceed the limit specified.

	<p>Environmental protection duration 10 years: It indicates that the period during which the harmful substances contained in the product will not be leaked or mutated, and the normal use of the product by the user under the circumstances described in the product manual will not cause serious pollution to the environment or serious damage to his/her life and property.</p> <p>Arrow Cycle Mark: It indicates that the product is recyclable. After the service life is expired or the product cannot work normally after maintenance, it should not be discarded at will. Please submit it to the formal recycling channel and the enterprise that has the qualification to dispose of the discarded electrical and electronic products. For the correct disposal method, please refer to the national or local regulations on the disposal of old electrical and electronic products</p>
--	--



# Warranty and Service

## Warranty and Service Instructions

If the product is damaged, please refer to warranty card and fill in the contents, and return product to the after-sales service center authorized by BUYDEEM for repair. The product model and serial number can be seen at the bottom of the product.

- Warranty is limited to production defects and damage caused by correct use of the manual.
- If power cord is damaged, it must be repaired or replaced by professional staff of manufacturer and after-sales service center to avoid danger.
- Customers who have passed the warranty period can contact BUYDEEM national service or contact [service@pandabrand.com](mailto:service@pandabrand.com) if want to buy spare parts.

The following conditions will not be subject to free maintenance

- No three guarantees voucher and valid invoice
- Failure to operate in accordance with the instructions
  - A. Damage caused by improper use, storage and maintenance by consumers.
  - B. Damage not caused by self-assembly and disassembly of the maintenance department designated by BUYDEEM.
  - C. Damage caused by force majeure.

For customers benefit, BUYDEEM reserves the right to modify the product features and components to ensure the normal use of the products.

For more services and information or any question, please visit our website [www.buydeem.com](http://www.buydeem.com), or contact [service@pandabrand.com](mailto:service@pandabrand.com), or contact local dealers. You can also cut out the warranty card to fill in information, and send product back to our company, and our professional staff will solve your problem for you.



## Warranty Card

1. According to the "New Three Guarantees", the product warranty period is one year (since the date of invoice issuing)
2. The invoice and warranty certificate together serve as the warranty certificate. Once the invoice is altered, the warranty will be invalid.
3. For damages caused by improper use or other non-product quality problems, part costs and labor costs will be charged.

Customer Name \_\_\_\_\_ Contact No. \_\_\_\_\_ Email \_\_\_\_\_

Product Model \_\_\_\_\_

Product Model \_\_\_\_\_ Purchase Date \_\_\_\_\_ Dealer \_\_\_\_\_

Machine No. \_\_\_\_\_

Date	Cause	maintenance man

Pandabrand Inc.  
Email: [service@pandabrand.com](mailto:service@pandabrand.com)