

Dual Battery Gauge Overview

Monitor your vehicle's Dual Battery System with a Dual Battery Gauge displaying voltage, current and temperature for each battery. Low voltage alarms (visual and audible), warning and excessive voltage levels can be set separately for each battery.

Why do you need a dual battery gauge to display battery voltages, currents and temperatures?

The idea of a dual battery system is to have all (or most) of your accessories connected to the second battery. As your accessories use power from the second battery, an isolator prevents power from draining from your main starting battery leaving it ready for you to start your vehicle when needed.

A dual battery system in a 4x4 is very handy, especially if you like running accessories from your 4x4 such as winches, compressors and lights. For most of us who enjoy camping and four wheel drive touring, one essential accessory is a portable electric fridge in the back.

To keep the fridge running while the vehicle is parked, you need plenty of reserve battery power. However, for many people, adequate electrical capacity is not just a convenience that helps keep your food and beer cool. It is also required for work: it powers equipment such as power tools, lights and radios when a vehicle is stationary.

So you have already installed your dual battery system using a solenoid isolator or something more complex. How do you know whether both batteries are charged and how much longer you can use your accessories? How do you know if your starter battery has enough charge to start in the morning?

This is why every dual battery system needs a Dual Battery Gauge to monitor, analyse and display;

- Voltage at the terminals of each battery.
- Current flowing in to (charging) and out of (discharging) for each battery.
- Ambient temperature of each battery

Why is the battery terminal voltage important?

The voltage of a lead-acid battery indicates the level of charge in the battery. As shown on the following table, discharging a battery below 40% is likely to reduce the life of the battery and it may not fully recover. Other battery technologies (eg lithium) also have recommended charge/discharge limits.

For example, a check of the battery voltage gives you the information to decide "does my reserve battery have enough charge to keep the fridge cold overnight?". "Should I switch over to the reserve battery to start the vehicle?" There are many situations where it is important to know the state of charge of your batteries.

| VOLTAGE | % CHARGE | NOTES |
|---------|----------|--|
| 15.1+ | | Excessive charging voltage |
| 15.0 | | Normal Operating Range when charging |
| 12.8 | | |
| 12.7 | 100 | Normal operating range. Measured under no load |
| 12.5 | 90 | |
| 12.4 | 80 | |
| 12.3 | 70 | |
| 12.2 | 60 | |
| 12.1 | 50 | |
| 11.9 | 40 | Discharging to these levels will reduce battery life |
| 11.8 | 30 | |
| 11.6 | 20 | |
| 11.3 | 10 | Battery will not fully recover |
| 10.5 | 0 | |

Why is monitoring current into and out of the battery important?

The current in shows the battery is being charged. Current out shows the battery is being discharged.

While the engine and alternator are running, the current flows show whether your main and reserve batteries are charging or discharging. When the vehicle is not running, the current flow shows how much current is being drawn from each battery by accessories such as fridges and lights.

For example, by monitoring the current flow it is possible to check the current drawn by various accessories, manage the total current drawn and avoid draining a battery too quickly.

Why is battery ambient temperature important?

Good quality lead-acid batteries perform reliably when exposed to extreme environments and have a wide operating temperature, ranging from -20°C to 50°C (-4°F - 120°F). However, battery capacity and/or battery life is reduced at the extreme temperatures.

Where ever possible batteries should be located where the ambient temperature is well within the extremes. For example, if the reserve battery can be installed in location away from excessive heat or cold then both the capacity and battery life will be improved.

Dual Battery Gauge Operation

This gauge allows you to monitor and set alarms for both batteries in any dual battery system. The gauge battery sensors are connected directly to each battery and cannot affect the operation of a dual battery system.

The Dual Battery Gauge uses digital technology and has a full colour screen to display voltages, currents, temperatures, settings and alarms.

You can set normal voltage levels which the display will show in **GREEN**. By setting the minimum voltage levels, an audible alarm and flashing **RED** display will be triggered if the minimum voltage level is exceeded. If the voltage level is below the normal level but above the minimum level, the display will show an **AMBER** warning. The gauge can also show the peak voltage and amperage levels reached since the gauge was powered on.

The gauge is designed to mount on the vehicle dash or similar surface. The outside dimensions are 60mm width, 52mm height, 20mm depth.

There are two gauge buttons - Menu and Settings. The steps required to set the battery alarms, adjust the screen brightness etc are easy to follow.

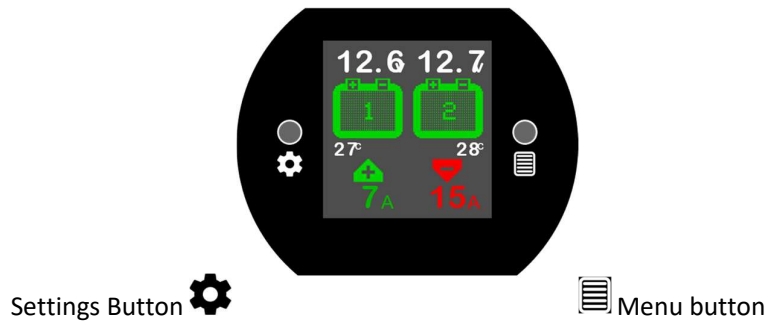

Simulated gauge display showing both batteries are fully charged.
Battery 1 is being charged (7 Amps). Battery 2 is supplying (discharging) 15 Amps.

Simulated Dual Battery Gauge Displays



Normal Battery Voltages
and Currents



Battery 2 Warning
Low Voltage



Battery 2 Low Voltage
Alarm Flashing and Audible

Note: Battery Warning and Alarm limits in the above displays can be set to your preferences

How it Works

The gauge receives continuous voltage, current and temperature measurements from two digital battery sensors mounted directly on batteries 1 and 2. The gauge and sensors are designed to monitor the typical 12v batteries installed in most street and 4WD vehicles.

Each digital battery sensor measures the precise voltage at the battery terminals and the charging/discharge current flowing in or out of the battery. The temperature at the battery sensor (attached directly to the battery terminal) is also measured.

All these measurements are converted by the sensor to digital signals which are continuously sent to the gauge for analysis and display. Unlike most standard voltage gauges, the Dual Battery Gauge is not affected by voltage drops in cables, magnetic interference or electrical noise.

The gauge displays battery voltage in 0.1 volt increments. Current is displayed in amperes charging (green) or discharging (red). Temperature is displayed in degrees Celsius or Fahrenheit (option).

For example, in the 3 simulated gauge displays above, the SAFE voltage level is 12.1v and the MINIMUM voltage level is 11.5v. The warning range is 11.5v to 12.0v.

By pressing the Settings button, the gauge will cycle through a display of the range of battery 1 and 2 parameters reached since the gauge was powered on.

The gauge display icons, settings and colours used are clear and easy to understand. One glance at the gauge and, if the battery icons are **GREEN**, all is normal.

Options

- Two digital battery sensors marked 1 and 2 are supplied with the gauge. Usually 1 is the main battery, 2 the reserve.
- Replacement sensors or sensors with longer cables are also available by contacting GaugeInnovations.
- Celsius and Fahrenheit temperature standards are supported. Please nominate the standard you require when ordering or refer to the Operation Summary for advice on how to change standard.

The gauge has been designed, developed, manufactured and extensively road tested in Australia. It is backed by a 12 month, return to manufacturer warranty against manufacturing defects.

The firmware, icons etc can also be modified to suit particular requirements. If you have a special requirement or a suggestion for improvement, contact GaugeInnovations.

Installation

What's in the box

- Dual Battery Gauge dash mounted 60mm width, 52mm height, 20mm depth.
- Gauge junction box to connect 12v DC power (to mount under the dash).
- Power connector plug and cable 12v DC. Red is positive, Black is negative chassis ground.
- Two digital battery sensors including cables (1 meter) and connectors. The Battery Sensors 1 and 2 are clearly marked. The shunts have a nominal rating of 300A but can carry and sense higher currents. .
- Junction box to mount under the vehicle bonnet.
- A cable (2.5 meters) with a plug at each end to connect the gauge to the junction box (normally through the firewall) 4 pin plug is at the gauge junction box end..
- Mounting hardware, double sided adhesive pads, cable ties etc.

Gauge installation is straightforward. Only three connections are required:

- One 5 pin plug from the gauge to the gauge junction box
- One 2 pin plug for power to the gauge junction box (2 wire, positive and negative)
- One 4 pin plug from gauge junction box to the battery sensor junction box (single cable to run through the firewall)

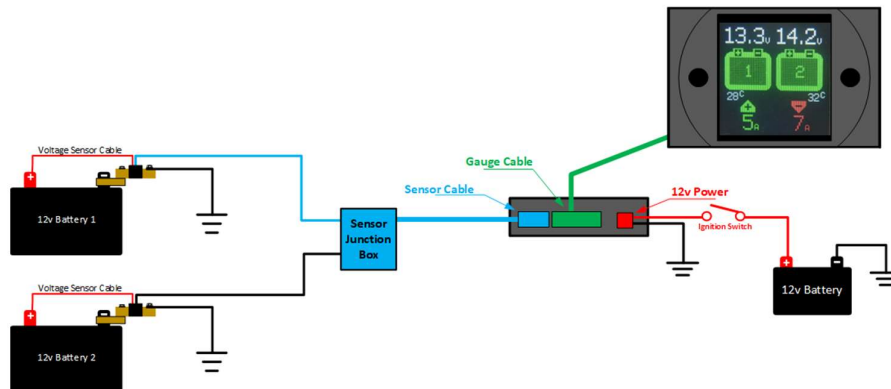

Wiring Diagram (gauge rear view)

The gauge requires 12 volts DC to operate. This should be from a fused, switched power source that is activated by the ignition key. The gauge requires less than 60ma current during normal operation.

For best viewing, avoid installing the gauge where it will often be in direct sunlight.

The cable from the gauge to the sensors will need to be run to the central junction box located under the bonnet. Normally this will be through the firewall. Loop and secure any excess cable length.

The junction box under the bonnet is secured in a convenient location where the sensor cables can be connected.

In the case of 4WD vehicles, the junction box should be located where it will not be submerged if driving through water. Alternatively, the junction box and cable entry points can be sealed using silicone or similar material.

The battery sensors are mounted using an M8 bolt to a standard battery terminal post clamp on the negative battery terminal post where the voltage and current will be measured.

NOTE: You should decide which of your vehicle batteries will be battery 1 and install the correct sensors on battery 1 and 2. The sensors are suitable for negative vehicle earths only.

Please take great care when connecting and disconnecting battery terminals. Accidental shorts can result in very high currents. Please remove both battery terminal connections when working on any one terminal. Always cover an exposed battery terminal with insulating material eg thick cloth or similar. And remember Murphy's law – a dropped tool will always go where it can do the most damage.

It is important that each battery sensor is installed as follows:

- The sensor is connected directly to the battery negative terminal to provide accurate voltage and current readings.
- The sensor is installed with the correct orientation. An arrow on the sensor points to the battery terminal end. Reverse sensor orientation will not damage the sensor but the voltage and amperage measurements will be incorrect

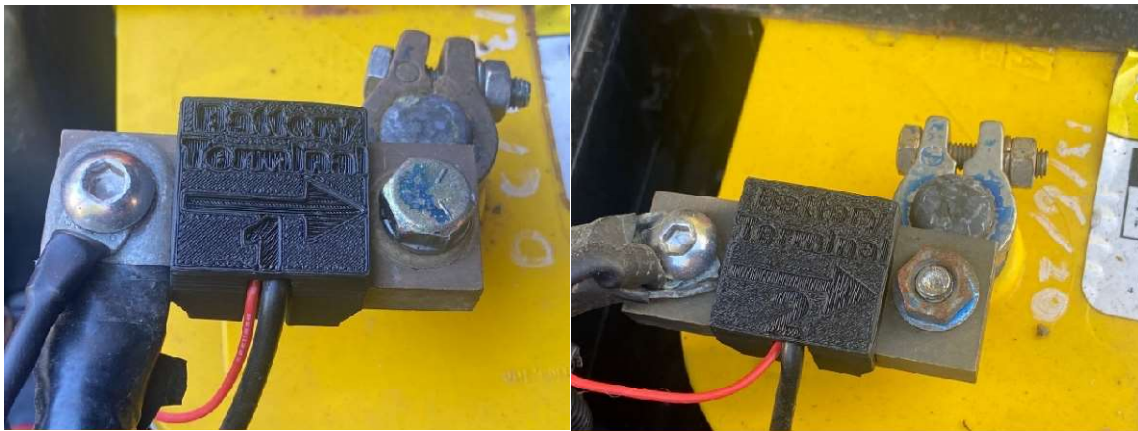

- The thin red voltage sensor cable is attached to the battery positive terminal (red). Note this cable is required to measure the voltage at the battery terminals. The cable carries no current, but has an integrated self resetting fuse as a safety feature.



- Both sensors must be well away from any sources of excessive heat such as exhausts, turbos etc.
- Sensors must be protected from mechanical damage to the sensor or its cable
- Sensors must be well away from sources of excessive electrical noise (eg spark plugs, distributor and two-way radios)

Dual Battery Gauge Menu and Settings Summary







Menu button cycles through the gauge settings screens.

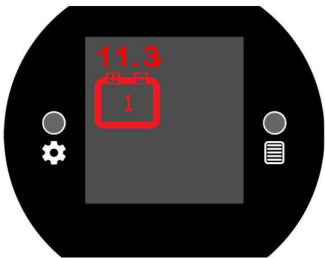

Settings button changes a setting. Press and hold to rapidly change a setting. The setting value will only change until it reaches the maximum or minimum value and then loop back to the start value where it will begin to change again with every press of the button.

Press the Menu or Settings button to silence an audible alarm.

| | |
|---|---|
|  | <p>1) SET THE MAXIMUM SAFE BATTERY 1 VOLTAGE</p> <p>Press and release the Menu button.</p> <p>Press the Settings button to adjust the maximum SAFE battery voltage. Typical value 15.0 volts</p> <p>The range is from the MINIMUM NORMAL OPERATING BATTERY 1 VOLTAGE to 18.0 volts.</p> |
|  | <p>2) SET THE MINIMUM NORMAL OPERATING BATTERY 1 VOLTAGE</p> <p>Press and release the Menu button again.</p> <p>Press the Settings button to adjust the minimum normal operating battery voltage. Typical value is 12.0 volts</p> <p>The range is from the MAXIMUM SAFE BATTERY 1 VOLTAGE to 0 volts.</p> |
|  | <p>3) SET THE LOW BATTERY 1 ALARM VOLTAGE</p> <p>Press and release the Menu button again.</p> <p>Press the Settings button to adjust the battery voltage which triggers the LOW BATTERY ALARM (flashing and audible). Typical value 11.3 volts.</p> <p>The range is from the MINIMUM NORMAL OPERATING BATTERY 1 VOLTAGE to 0 volts.</p> |
|  | <p>4) SET THE MAXIMUM SAFE BATTERY 2 VOLTAGE</p> <p>Press and release the Menu button.</p> <p>Press the Settings button to adjust the maximum SAFE battery voltage. Typical value 15.0 volts</p> <p>The range is from the MINIMUM NORMAL OPERATING BATTERY 2 VOLTAGE to 18.0 volts.</p> |

| | |
|---|---|
|  | <p>5) SET THE MINIMUM NORMAL OPERATING BATTERY 2 VOLTAGE</p> <p>Press and release the Menu button again.</p> <p>Press the Settings button to adjust the minimum normal operating battery voltage. Typical value is 12.0 volts</p> <p>The range is from the MAXIMUM SAFE BATTERY 2 VOLTAGE to 0 volts.</p> |
|  | <p>6) SET THE LOW BATTERY 2 ALARM VOLTAGE</p> <p>Press and release the Menu button again.</p> <p>Press the Settings button to adjust the battery voltage which triggers the LOW BATTERY ALARM (flashing and audible). Typical value 11.3 volts.</p> <p>The range is from the MINIMUM NORMAL OPERATING BATTERY 2 VOLTAGE to 0 volts.</p> |
|  | <p>7) SET SCREEN BRIGHTNESS</p> <p>Press and release the Menu button again.</p> <p>Press the Settings button to adjust the screen brightness.</p> |
|  | <p>8) TURN AUDIBLE ALARM ON/OFF</p> <p>Press and release the Menu button again.</p> <p>Press the Settings button to turn the audible alarm on or off.</p> <p>NOTE: If the audible alarm is turned off, there will be no audible warning of LOW BATTERY alarms. Please remember to keep the audible alarm setting on whenever you drive.</p> |
|  | <p>9) SAVE SETTINGS AND RETURN TO MONITORING MODE</p> <p>Press and release the Menu button again.</p> <p>The gauge will also revert to the normal monitoring mode after approximately 30 seconds of no Menu or Settings button activity.</p> |



7) DISPLAY BATTERY MAXIMUM AND MINIMUM VALUES

Press the Settings button while the gauge is in monitoring mode to toggle off/on the display of the battery 1 and battery 2 maximum and minimum values reached since the gauge was powered on. For each battery, the display shows maximum and minimum voltages and temperature as well as the maximum charge (green) and discharge (red) currents.



To restore the gauge to factory default settings - Press and hold the Settings button while the gauge is being powered on.



To toggle between Celsius and Fahrenheit standards and restore the gauge to factory default settings - Press and hold both the Menu and Settings button while the gauge is being powered on.