

SOLAR ALL-IN-ONE ESS

5Kw Off-Grid Inverter

For 5Kwh~15Kwh Stackable Battery Energy Storage System

10Kw Off-Grid Inverter

For 10Kwh~50Kwh Stackable Battery Energy Storage System



———— User Manual ————

Contents

Manual Information	2
Applicable Products	2
Scope of Application	2
Target Groups	2
Safety Instructions	2
Introduce	4
Product Description	5
Installation	6
Unpacking Inspection	6
Preparation	6
Installation Device	6
Lithium Battery Connection	7
Lithium Battery Communication and Settings	9
AC Input / Output Connections	9
PV Connection	11
PV Module Selection:	11
RUN	12
Operation Panel Description	12
1.1 Four-Key Function	12
1.1.1 LED Indicator Function	13
1.1.2 LCD Function Display	13
1.1.3 Inverter working status table of the buzzer	14
1.2 Daily Power on and Off	15
1.2.1 Startup Procedure	15
1.2.2 Shutdown Procedure	15
1.2.3 Mute operations	15
1.2.4 Operations performed in the Alarm State	15
1.2.5 Operations in Fault Mode	15
1.3 Parameter Query operations	15
1.4 Function Setting Operations	19
1.4.1 Output Voltage (OPU)	20
1.4.2 Setting Other Functions	20
1.5 Fault and Alarm Description	38
1.5.1 Fault Description	38
1.5.2 Alarm Description	40
Specifications	43
Table 1 Line Mode Specifications	43
Table 2 Inverter Mode Specifications	44
Table 3 Charging Mode Specifications	45
Table 4 General Specifications	45

Manual Information

Applicable Products

5000TL — 5Kw Off Grid Inverter

10000TL — 10Kw Off Grid Inverter

Scope of Application

This manual describes the assembly, installation, operation and troubleshooting of this equipment. Please read this manual carefully before installation and operation.

Target Groups

This document is intended for qualified personnel and end users. Tasks that do not require any specific qualifications can also be performed by end users. Qualified personnel must possess the following skills:

- ▶ Learn how an inverter works and operates
- ▶ Training on how to deal with the hazards and risks associated with the installation and use of electrical equipment and devices
- ▶ Training on the installation and commissioning of electrical equipment and devices
- ▶ Understand applicable standards and directives
- ▶ Understand and obey this document and all safety information

Safety Instructions

WARNING: This chapter contains important safety and operating instructions. Please read and save this manual for future reference.

1. Please clarify which battery system you want, lithium battery system or lead-acid battery system. If you choose the wrong battery system, the energy storage system will not work properly.
2. Before using the device, read all instructions, warning markings on the device, batteries, and all appropriate sections of this manual. If installation is not carried out in accordance with this manual and equipment damage is caused, the company has the right to void the warranty.
3. All operations and connections must be performed by professional electrical or mechanical engineers.
4. All electrical installations must comply with local electrical safety standards.
5. When installing photovoltaic modules during the day, the installer should cover the PV modules with opaque materials. Otherwise, high module terminal voltage may cause danger in the sun.
6. **NOTE:** To reduce the risk of injury, charge only deep-cycle lead-acid rechargeable and lithium batteries. Other types of batteries may burst, causing personal injury and damage.

7. Do not disassemble the device. When service or repair is required, take it to a qualified service center.
Improper assembly may result in risk of electric shock or fire.
8. To reduce the risk of electric shock, disconnect all electrical cords before attempting any maintenance or cleaning. This risk can be reduced by turning off the device.
9. Never charge a frozen battery.
10. For optimal operation of this inverter, please select the appropriate cable size according to the required specifications. Proper operation of this inverter is very important.
11. Be very careful when using metal tools on or around batteries. Throwing tools may generate sparks or short-circuit batteries or other parts, and may cause an explosion.
12. When you want to disconnect the AC or DC terminals, please strictly follow the installation procedures. Please refer to the installation section of this manual for details.
13. Grounding Instructions - This inverter should be connected to a permanently grounded wiring system. When installing this inverter, local requirements and regulations must be observed.
14. Do not short-circuit the AC output and DC input. When the DC input terminal is short-circuited, do not connect it to the mains.
15. Before operation, make sure the inverter is fully assembled.

Introduce

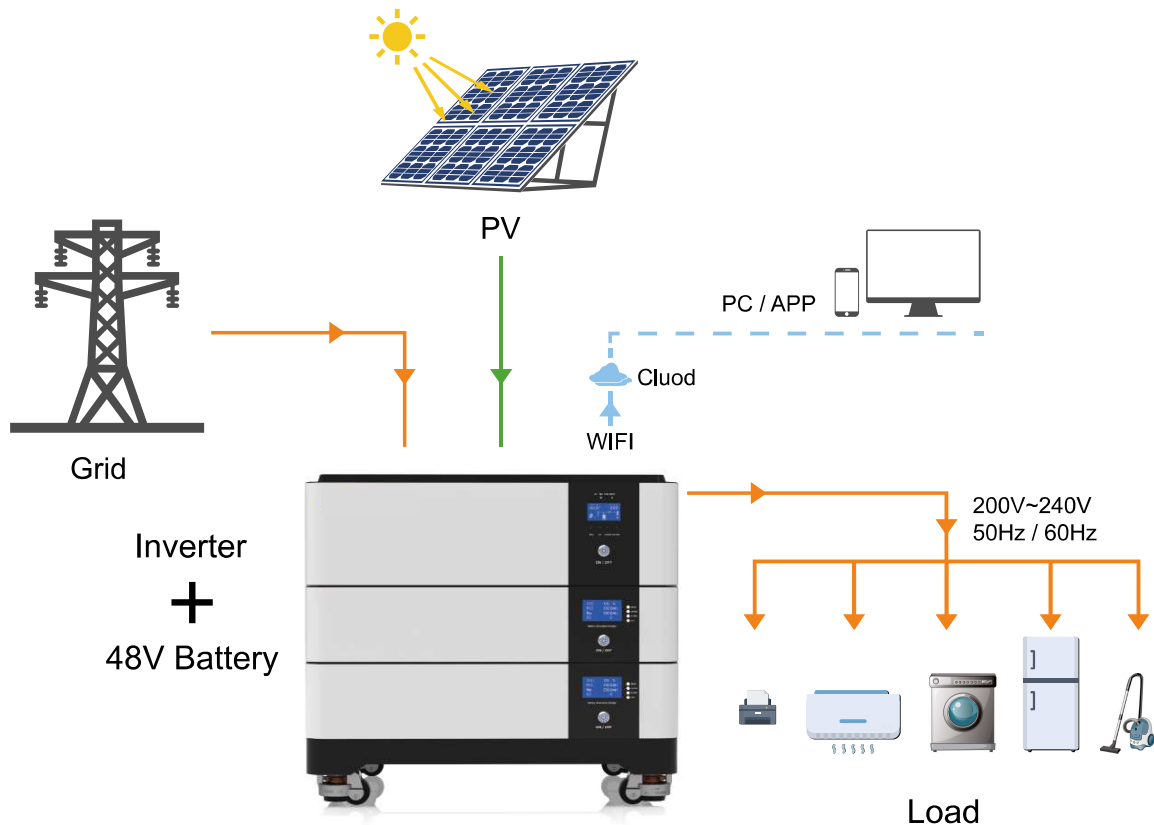

All-In-One Energy Storage System

This is a multifunctional off-grid solar inverter + lithium battery home energy storage system; it integrates MPPT solar charge controller, high-frequency pure sine wave inverter and UPS functional module, and is equipped with 48V stacked LiFePO4 Battery's energy storage system is very suitable for off-grid backup power and home power supply.

The entire system also requires other equipment for complete operation, such as photovoltaic modules, stacked energy storage batteries, generators or utility grids. Please consult your system integrator for other possible system architectures based on your needs. The WiFi/GPRS module is a plug-and-play monitoring device to be installed on the inverter. Using this device, users can monitor the status of the PV system anytime, anywhere via mobile phone or website.

Product Features

- ▶ Rated power 5KW(5000TL) 10 KW(10000TL), power factor 1
- ▶ MPPT range 120V~430V, 450VDC
- ▶ Pure sine wave AC output
- ▶ Solar grid and utility grid can power loads simultaneously
- ▶ Use CAN/RS485 for BMS communication
- ▶ WIFI remote monitoring (optional)

Product Description

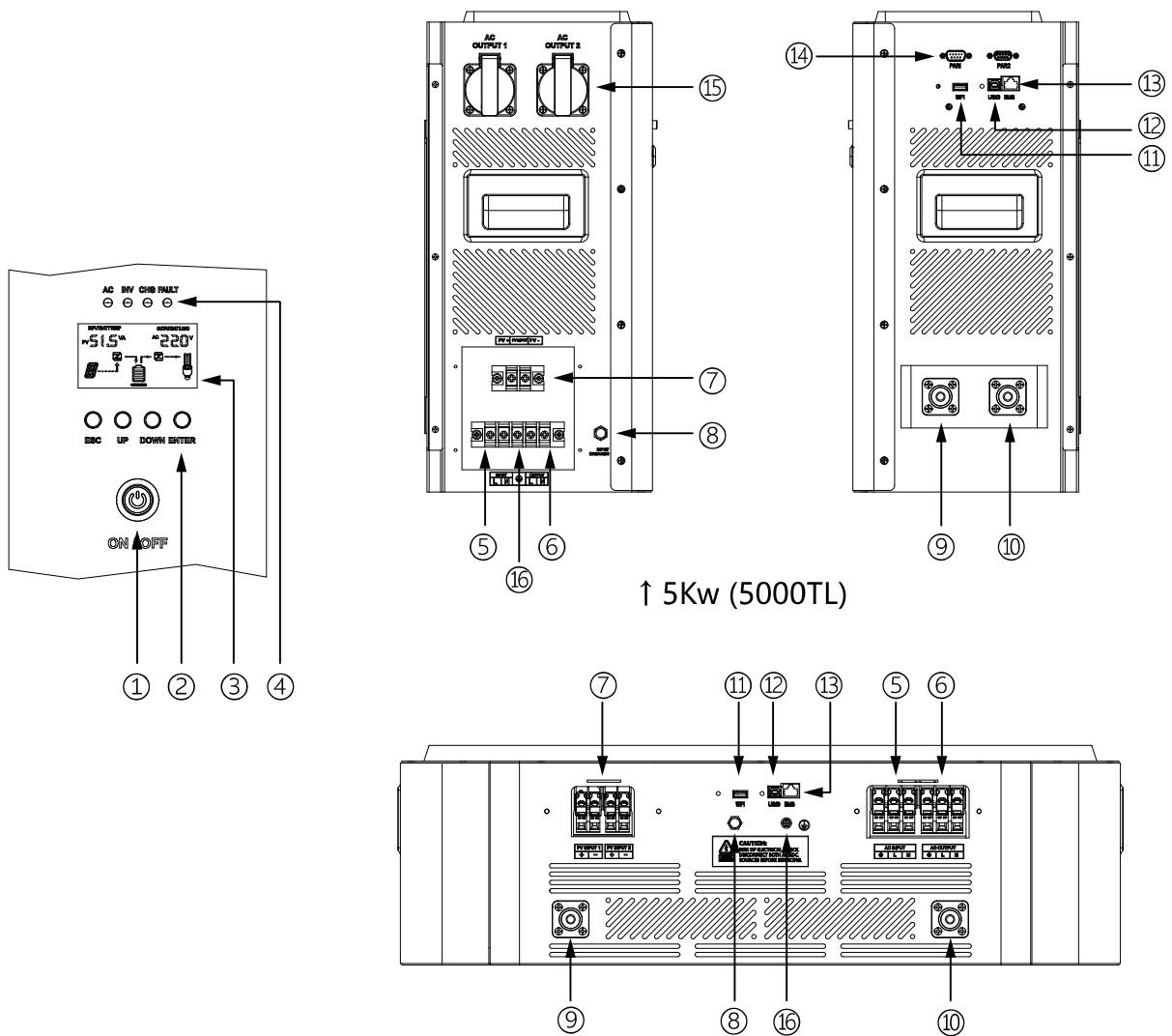

↑ 5Kw (5000TL)

↑ 10Kw (10000TL)

- ① Inverter Switch
- ② Function Button
- ③ LCD Display
- ④ Status Indicator
- ⑤ AC Input
- ⑥ AC Output
- ⑦ PV Input
- ⑧ Input Breaker
- ⑨ Battery Positive +
- ⑩ Battery Negative -

- ⑪ WIFI (optional)
- ⑫ USB
- ⑬ BMS
- ⑭ Parallel Communication Port
(Only supported by 5000TL)
- ⑮ AC Output Socket
(Only supported by 5000TL)
- ⑯ Ground Wire

Installation

Unpacking Inspection

This manual describes the assembly, installation, operation and troubleshooting of this equipment. Please read this manual carefully before installation and operation.

- ▶ Inverter equipment x1
- ▶ AC input connector x1
- ▶ AC output connector x1
- ▶ PV input connector x1
- ▶ User manual x1
- ▶ Smart Wifi Stick (optional x 1)

Preparation

Before connecting all wiring, remove the user interface cover.

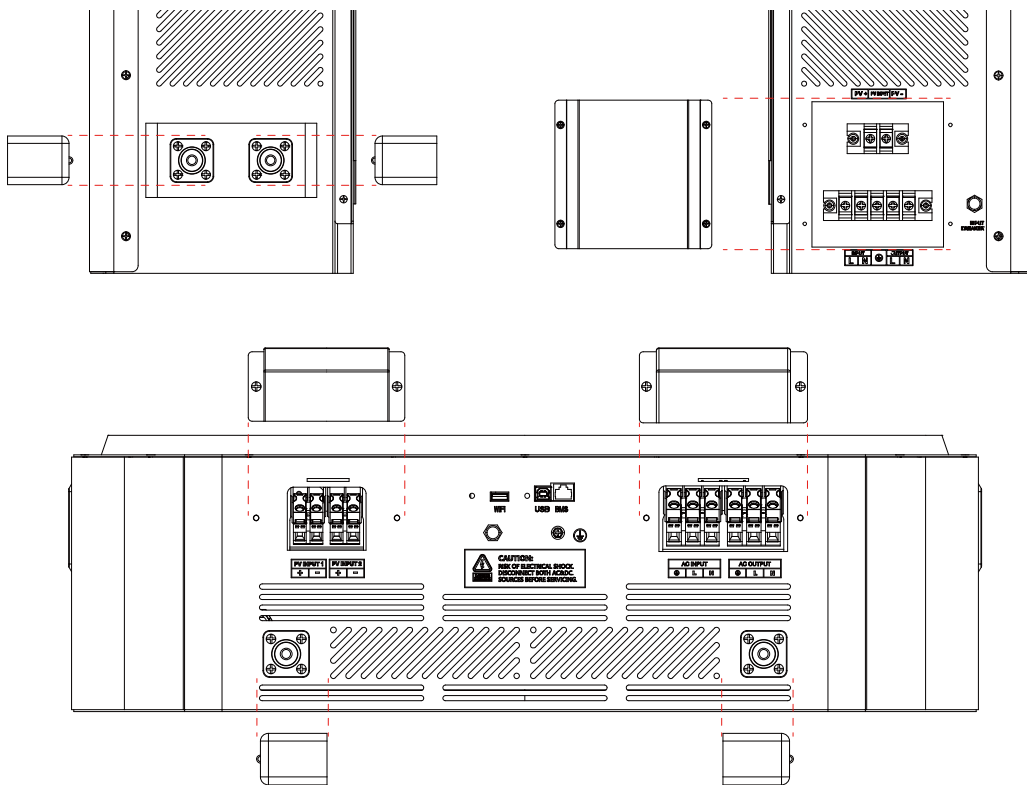

Installation Device

Before choosing where to install, consider the following:

- ▶ Do not install the inverter on flammable building materials.
- ▶ Install on load-bearing wall surface.
- ▶ Mount the display of this inverter at eye level to allow the LCD to be read at all times.
- ▶ Ambient temperature should be between 0°C and 55°C to ensure optimal operation.
- ▶ The recommended installation position should be vertically attached to the wall.
- ▶ Make sure other objects and surfaces are as shown below to ensure adequate heat dissipation and enough space to remove wires.

NOTE: For installation on concrete or other non-combustible surfaces only.

Lithium Battery Connection

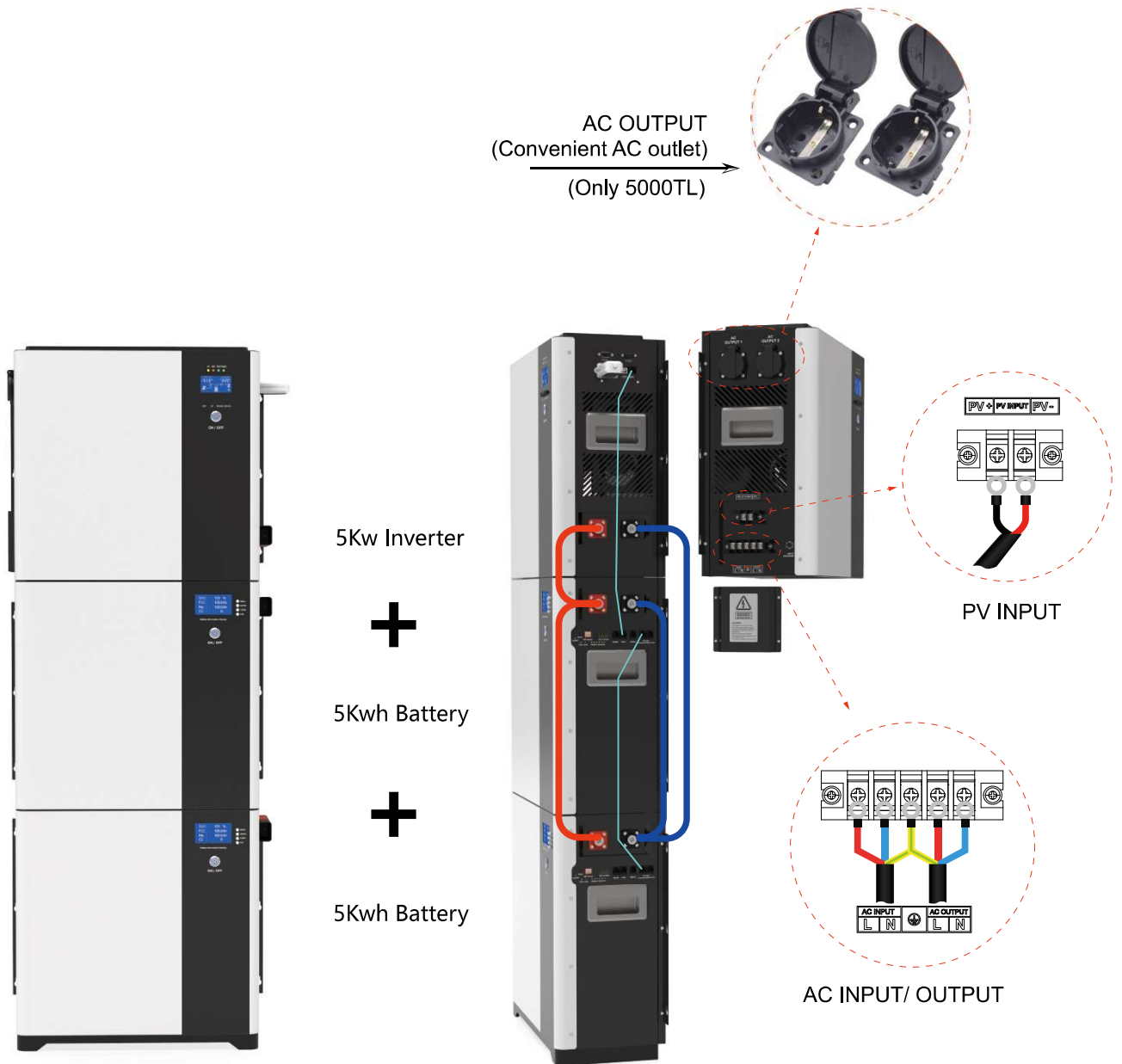

↑ 10Kwh + 5Kw ESS Wiring diagram

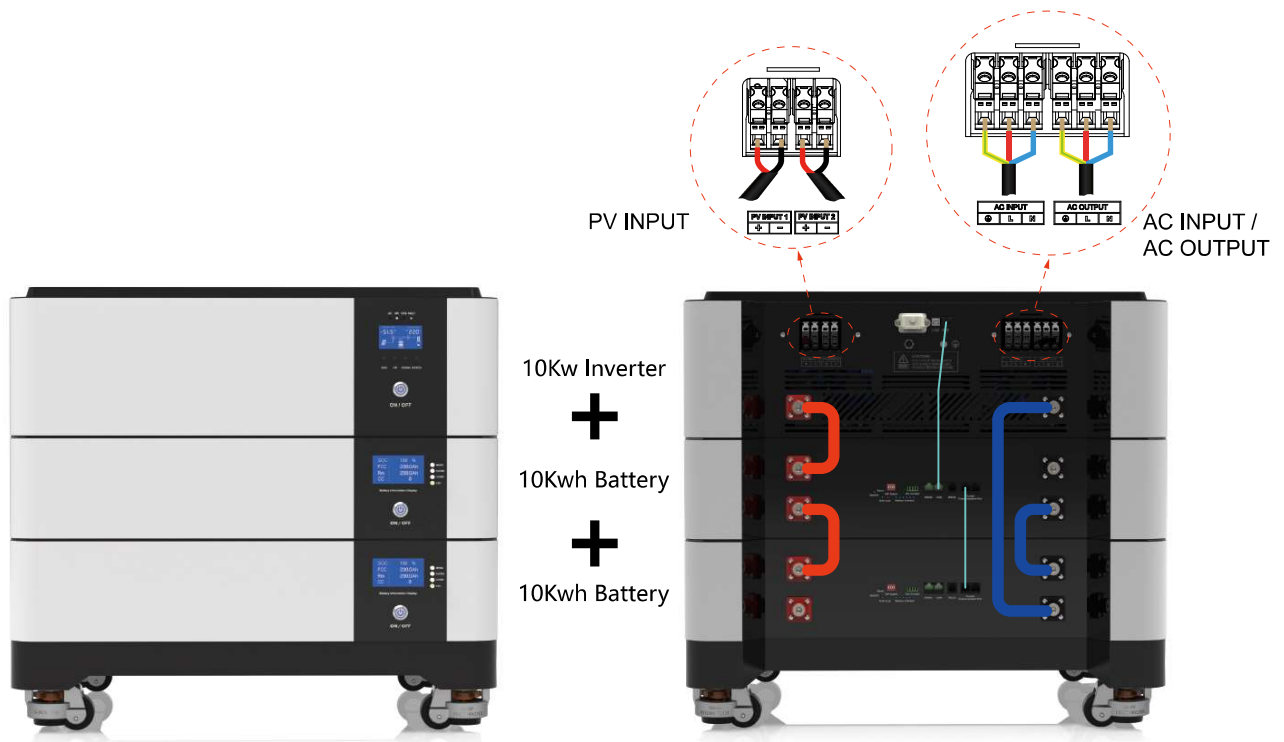

↑ 20Kwh + 10Kw ESS Wiring diagram

If 5000TL / 10000TL uses lithium batteries, you can only use the lithium batteries we have configured. There are two connectors on the lithium battery, the RJ45 port of the BMS and the power cable.

1. Assemble battery ring terminals according to recommended battery cable and terminal sizes (same as lead acid, see Lead Acid Battery Connections section for details).
2. Insert the ring end of the battery cable directly into the battery input terminal of the inverter and ensure that the bolts are tightened to a torque of 2-3Nm. Make sure the battery and inverter polarity are connected correctly and the ring terminals are tightened to the battery terminals.
3. Connect the RJ45 end of the battery to the BMS communication port (RS485 or CAN) of the inverter.
4. Plug the other end of the RJ45 into the battery communication port (RS485 or CAN)

Note: If you choose lithium battery, please make sure to connect the BMS communication cable between the battery and the inverter. You need to select the battery type as "Lithium Battery".

Lithium Battery Communication and Settings

In order to communicate with the battery BMS, you should set the battery type to "LI" in LCD screen setting item 17.

Then set item 38 of the LCD screen to set the BMS to ON or OFF to turn on or off the BMS communication function.

Connect the RJ45 end of the battery to the BMS communication port of the inverter

Make sure that the lithium battery BMS port connected to the inverter port has a one-to-one pin correspondence. The inverter BMS port is defined as follows:

Inverter			Battery	
Pin	BMS Port		Pin	CAN Port
1	RS485B		/	
2	RS485A		/	
3	/		/	
4	CANH		CANH	
5	CANL		CANL	
6	/		/	
7	/		GND	
8	/		/	

AC Input / Output Connections

CAUTION!! Before connecting to AC input power source, please install a separate AC breaker between inverter and AC input power source. This ensure the inverter can be securely disconnected during maintenance and fully protected from over current of AC input. The recommended specification of AC breaker is 40A for 5000TL / 10000TL.

CAUTION!! There are two terminal blocks with "IN" and "OUT" markings. Please do NOT misconnect input and output connectors.

WARNING! All wiring must be performed by a qualified personnel.

WARNING! Its very important for system safety and efficient operation to use appropriate cable for AC input connection. To reduce risk of injury, please use the proper recommended cable size as below.



Recommended cable requirements for AC power lines

Model	Wire Gauge	Cable (mm ²)	Torque Value
5000TL	9-10AWG	6	1.2-1.6 Nm
10000TL	8AWG	8	1.2-1.6 Nm

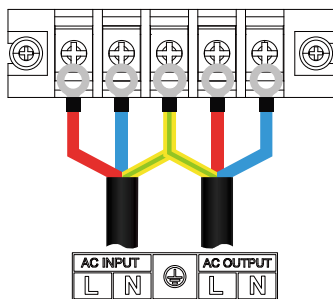

5000TL

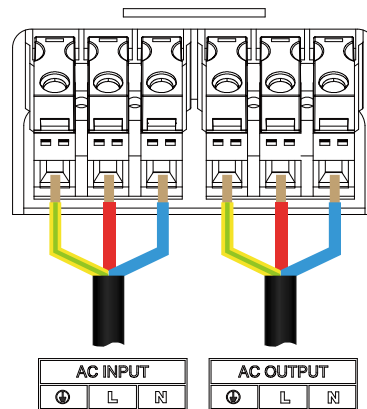

10000TL



WARNING:

Be sure that AC power source is disconnected before attempting to connect the hard wire to the unit.

WARNING: Important !!!

Be sure to connect AC wires with correct polarity. If L and N wires are connected reversely, it may cause utility short-circuited when these inverters are worked in parallel operation.



CAUTION:

Appliances such as air conditioner need at least 2~3 minutes to restart because it requires to have enough time to balance refrigerant gas inside of circuits. If power shortage occurs and recovers in a short time, it will cause damage to your connected appliances. To prevent this kind of damage, please check with manufacturer of air conditioner if it's equipped with time-delay function before installation. Otherwise, this off grid solar inverter will trigger overload fault and cut off output to protect your appliance but sometimes it still causes internal damage to the air conditioner.

PV Connection

Caution: Before connecting to the PV modules, please install a DC circuit breaker between the inverter and the PV modules.

WARNING! All wiring must be done by qualified personnel.

WARNING! The use of appropriate cables to connect PV modules is very important for safe and efficient operation of the system. To reduce the risk of injury, use proper connection methods. To reduce the risk of injury, use the appropriate cable sizes recommended below.

Model	Wire Gauge	Cable (mm ²)	Torque Value
5000TL	10AWG	5	1.2-1.6 Nm
10000TL	2 x 10AWG	5	1.2-1.6 Nm

PV Module Selection:

When choosing the right photovoltaic modules, be sure to consider the following parameters

1. The open circuit voltage (Voc) of the photovoltaic module does not exceed the maximum open circuit voltage of the inverter's photovoltaic array.
2. The open circuit voltage (Voc) of the photovoltaic module should be higher than the minimum battery voltage.
3. Only one photovoltaic module can be connected to one, otherwise the inverter will be damaged.

Inverter Model	5000TL	10000TL
Maximum open circuit voltage of photovoltaic array	450Vdc	450Vdc x 2
Starting Voltage	150Vdc	150Vdc
Photovoltaic array MPPTX operating voltage range	120Vdc~430Vdc	120Vdc~430Vdc x 2

Please follow the steps below to connect the photovoltaic modules:

1. Insert the positive and negative cables of the PV panel and strip them, then connect the positive pole (+) of the connecting cable to the positive pole (+) of the PV input connector, and connect the negative pole (-) of the connecting cable to the negative pole (-) of the PV input connector.
2. Make sure the wire connections are secure.

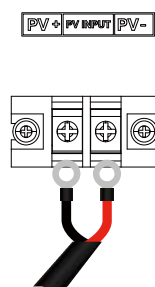

5000TL

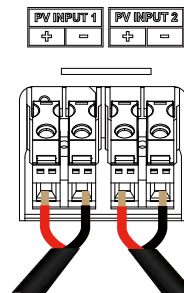

10000TL

RUN

Once the unit is installed correctly and the battery is well connected, simply press the ON / OFF (located under the operating panel) to turn the unit on.

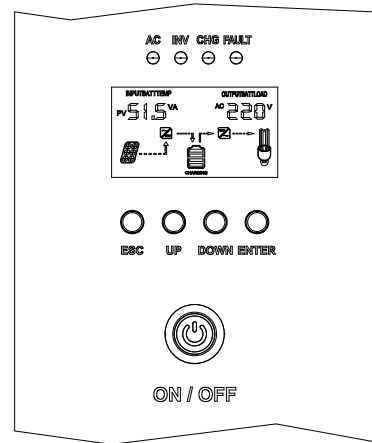

Operation Panel Description

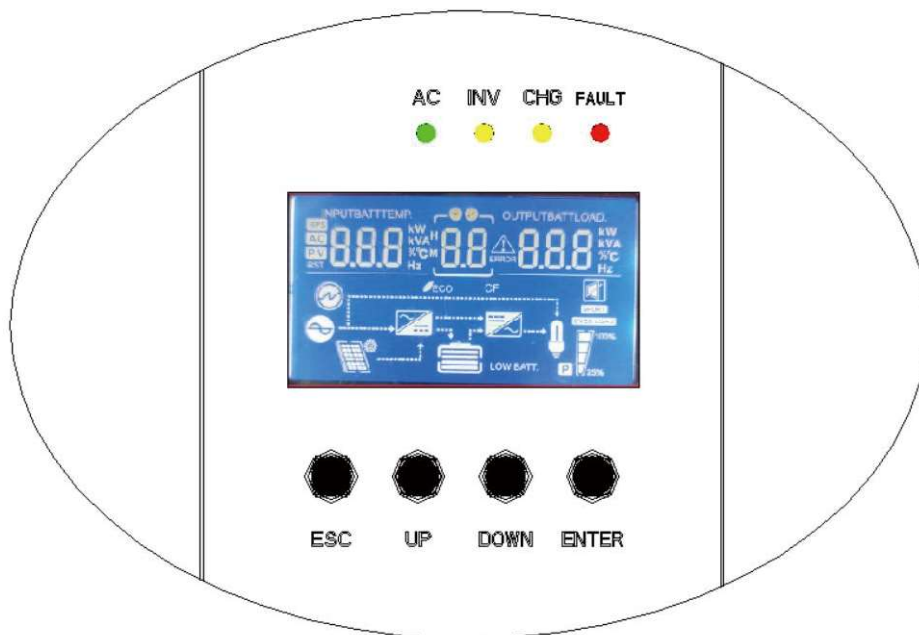

1.1 Four-Key Function

Button	Functional Specifications
Function Setting / Identification Key	Function setting: Press the Enter key on the display page for more than 2 seconds to enter the function setting page. After entering the setting interface, press the UP or DOWN key to open the upper and lower pages and select the interface to be set. Confirm: On the "Function Settings" page, press the ESC key for 0.1 to 2 seconds to confirm the setting options.
Page Turning / Query Key	Page turning: Press and hold the UP or DOWN key on any page for more than 0.1 seconds to change pages left or right.

1.1.1 LED Indicator Function

LED Indicator Light		Explanation	
AC	Green	Steady ON	The mains power is normal and the mains power is working
		Flashing	Mains power is normal, but mains power is not working
		OFF	Mains power abnormality
INV	Yellow	Steady ON	The machine works in battery mode
		OFF	Other status
CHG	Yellow	Steady ON	Battery is charging
		Flashing	The battery is charged at constant voltage
		OFF	Other status
FAULT	Red	Steady ON	Inverter failure
		Flashing	The inverter has an alarm
		OFF	Inverter normal

Function Button

Button	Describe
ESC	Exit setup mode
UP	Go to previous option
DOWN	Go to next option
ENTER	Confirm selection or enter setup mode in setup mode

1.1.2 LCD Function Display

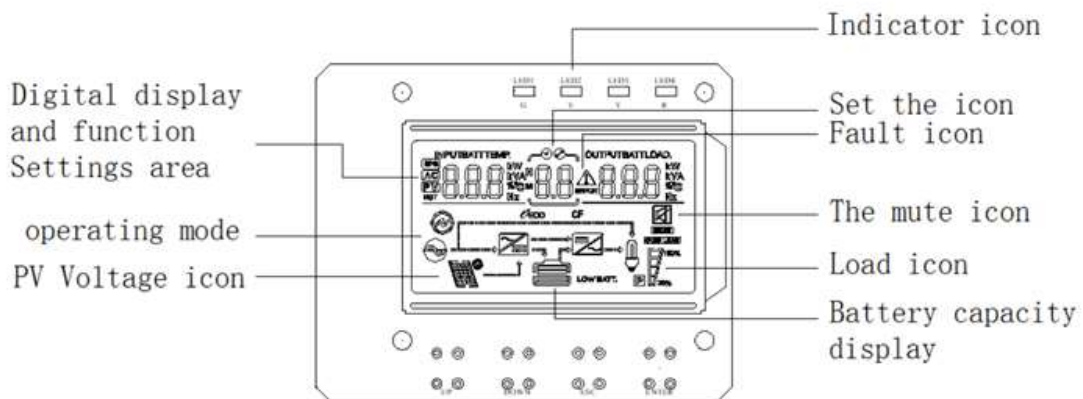

Figure 1-2 Four-button LCD screen

LCD display can be divided into: icon display, numerical display and function setting area, working mode display area.

Icon display:

- Load and battery graph indicates load and battery capacity. Each square represents 25% of the capacity. The load icon blinks when the inverter is overloaded, and the battery icon blinks when the battery capacity is too low or the battery is not connected.
- Buzzer icon Indicates whether the buzzer is silent. Normally, this icon is not displayed. In any mode, the backstage software sets MUTE ON, the inverter enters the MUTE state, and the buzzer disabled icon will be displayed.
- The Settings icon will be on when enter the Settings menu. Otherwise, the icon will not be displayed.
- The fault icon is displayed only in fault mode. In other cases, the fault icon is not displayed.

Value display and function setting area:

- In non-functional mode, the inverter information is displayed in this area. Output information is displayed in normal mode. Operation query key (UP or DOWN key) can display input voltage and output voltage, input frequency and output frequency, battery voltage and current, PV voltage and PV current, PV voltage and power, output power and output voltage, output apparent power and output voltage, load percentage and output voltage, software version and other related information. Fault mode displays the fault code.
- On the Function Setting page, you can set the output voltage (OPU) and battery low-voltage shutdown point (EOd) by using the Operation function setting key and the UP and Down searching keys.

Working mode display area:

- After starting for 4 seconds, this display area mainly displays the working mode of the inverter. For example, standby mode, utility grid mode, battery mode, and Fault mode.

1.1.3 Inverter working status table of the buzzer

A buzzer alarm is generated	Describe
A long sound lasts ten seconds and then stops	Failure mode
The long sound stops after three seconds	The PV/input voltage is lost or recovered
	The main switch of startup is turned on or off
Sound one time per second, last for one minute, and then stop	All other alarms (it will beep for low battery voltage only in battery mode)

1.2 Daily Power on and Off

Please refer to this manual for switching on and off the machine.

1.2.1 Startup Procedure

The device can be started when a qualified battery or mains power is connected (the mains input range must comply with the output mode).

► Utility grid switch on

Connect to utility grid, press the switch, and switch to ON. The system starts. If utility grid output is preferred, wait for a while until the utility grid mode is displayed ON the rear panel.

► The battery switch on

Connect to the normal battery, press the switch, the inverter to establish working power supply. The system automatically starts. After a while, the system enter the battery mode if the battery mode is displayed on the rear panel,.

1.2.2 Shutdown Procedure

Press the switch again to turn it OFF when the system is in battery mode or utility grid mode, and the system will shut down.

1.2.3 Mute operations

Can set MUTE ON or OFF to MUTE or unmute the inverter when the inverter is in any mode.

1.2.4 Operations performed in the Alarm State

It indicates that the inverter is in the alarm state if the inverter has an alarm sound and the LED fault indicator blinks. You can locate the cause of the alarm or contact the supplier based on the alarm information.

1.2.5 Operations in Fault Mode

It indicates that the inverter is working in fault mode when the inverter buzzer is always ringing and the LED fault indicator is always on. Contact the supplier or maintenance personnel to provide information about the fault alarm and help to troubleshoot the fault.

1.3 Parameter Query operations

Under normal circumstances, it has a total of ten pages for the display. Press the query key UP or DOWN 0.2 to 1 second to turn the display page, display input and output voltage, input and output frequency, battery, PV voltage and current, load, software version, and other information. A page of alarm information is added if an alarm is generated. The fault code page is displayed by default If the inverter is faulty. The fault or alarm information is displayed on the main page by default. The output voltage and frequency information are displayed on the main page by default when the inverter has no fault or alarm.

**Display page 1
(main display page) :**

Displays the inverter input and output voltages, as shown in Figure 1-3

Figure 1-3 shows page 1 →

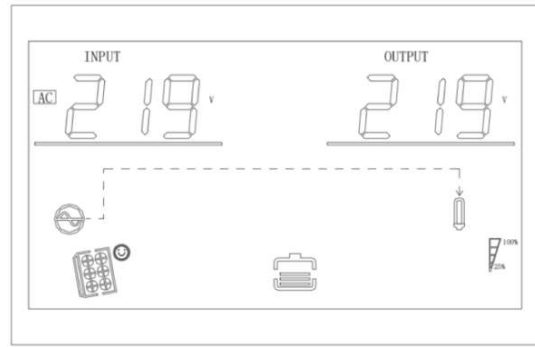

Display page 2 :

Displays the inverter input and output frequency, as shown in Figure 1-4

Figure 1-4 Showing page 2 →

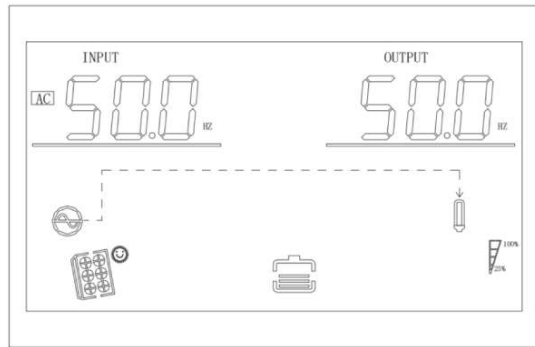

Display page 3 :

Battery information is displayed, showing the battery voltage and charging current, as shown in Figure 1-5

Figure 1-5 shows page 3 →

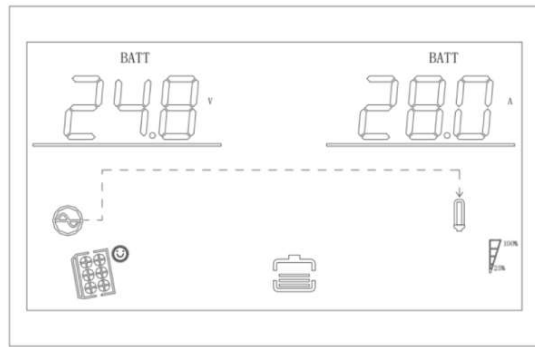

Display page 4 :

PV information is displayed, showing the PV voltage and PV charging current, as shown in Figure 1-6

Figure 1-6 shows page 4 →

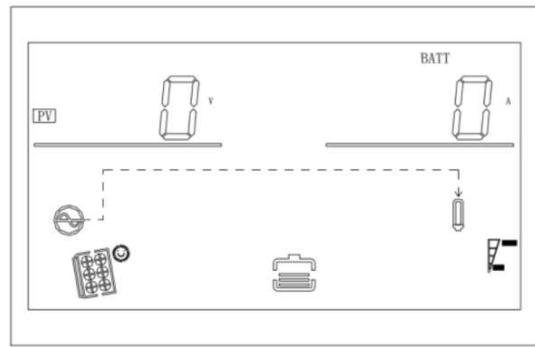

Display page 5 :

PV Information is displayed, showing the PV voltage and PV charging power, as shown in Figure 1-7

Figure 1-7 Display page 5 →

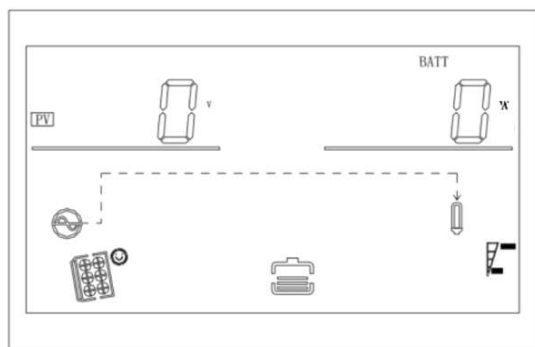

Display page 6 :

Output Information is displayed, showing the output voltage and active power, as shown in Figure 1-8

Figure 1-8 Display page 6 →

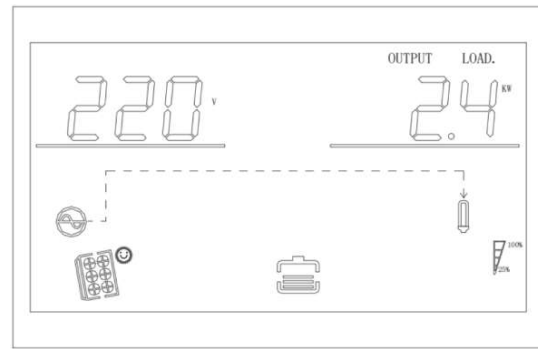

Display page 7 :

Output Information is displayed, showing the output voltage and output complex power, as shown in Figure 1-9

Figure 1-9 shows page 7 →

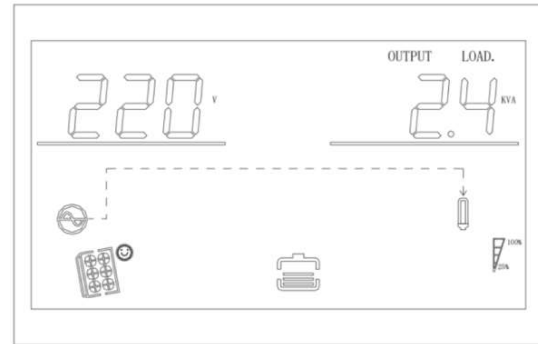

Display page 8 :

Output information is displayed, showing the voltage and load percentage, as shown in Figure 1-10

Figure 1-10 Display page 8 →

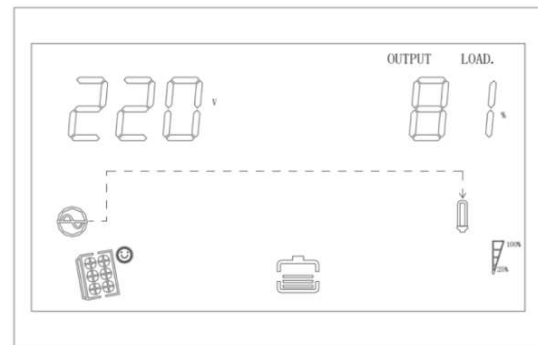

Display page 9 :

The software version of the inverter is displayed, as shown in Figure 1-11

Figure 1-11 Display page 9 →

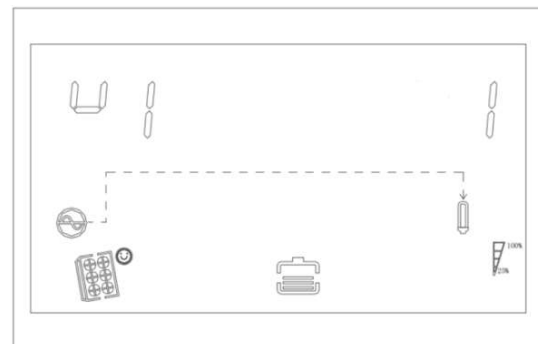

Display page 10 :

Displays the MPPT software version, as shown in Figure 1-12

Figure 1-12 shows page 10 →
Figure 1-17 Display Page 15
(lithium battery capacity information) →

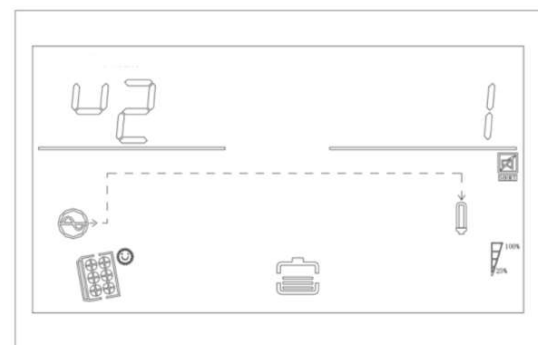

Display page 11 :

Shows the photovoltaic power generation, as shown in Figure 1-13

Figure 1-13 Display Page 11 (parallel status) →

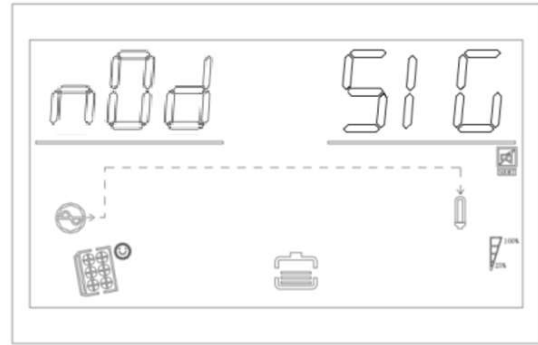

Display page 12 :

Lithium battery networking status; For SIG constant, the battery pack is in single group operation; For PAR constant, the battery pack is in parallel operation; The battery pack is in parallel operation when PAR is flashing.

Figure 1-14 Display page 12 (lithium battery networking status) →

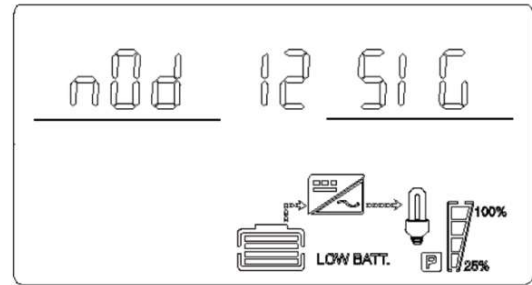

Display page 13 :

Lithium battery battery voltage and current information; BMS voltage information is displayed on the upper left; and BMS current information is displayed on the upper right. The upper left and right shows the flashing ERR when BMS communication fails.

Figure 1-15 Display Page 13 (lithium battery voltage and current information) →

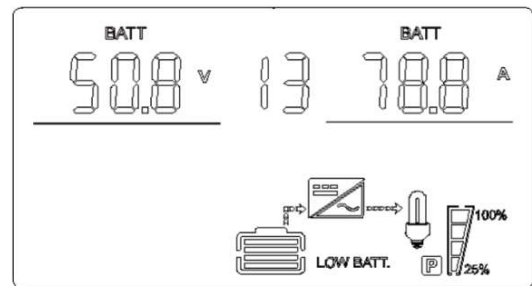

Display page 14 :

Lithium battery temperature and SOC. BMS temperature is displayed on the upper left and BMS SOC is displayed on the upper right. It flashes ERR when BMS communication fails.

Figure 1-16 Display Page 14 (lithium battery temperature & SOC information) →

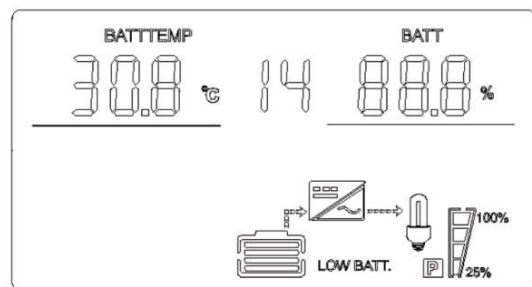

Display page 15 :

Lithium battery capacity; The rated capacity is displayed on the upper left and the current capacity displayed on the upper right. The upper left and right show the flashing ERR when BMS communication fails.

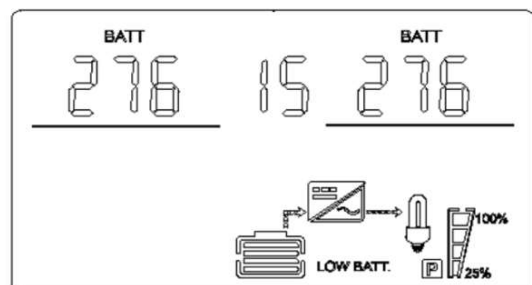

Display page 16 :

Constant voltage point of lithium battery;
Fixed letter CV is displayed on upper left and
BMS constant voltage charging point is
displayed on the upper right. The upper left
and right show the flashing ERR when the
BMS communication fails.

Figure 1-18 Display page 16
(lithium battery battery constant voltage information) →

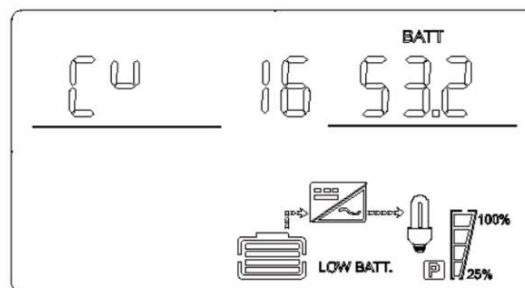

Display page 17 :

Lithium battery fault alarm information;
BMS alarm information on the upper left;
BMS fault information on the upper right.
It flashes ERR on upper left and upper right
when BMS communication fails.

Figure 1-19 Display page 17
(lithium battery fault alarm information) →

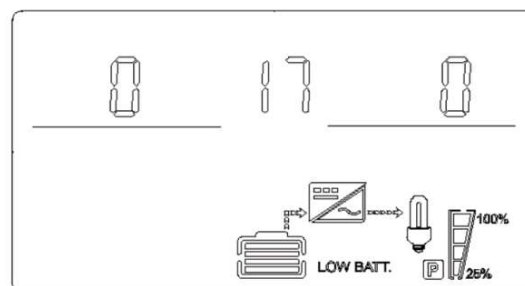

1.4 Function Setting Operations

► Function setting operation of inverter:

Enter the exit function setting page and the operations details are as below:

- Press the function setting key ENTER for more than 2 seconds to enter the function setting page. Press the query key UP or DOWN for 0.1 to 2 seconds to select the function. The corresponding function will blink after turning the page to the required function setting page.
- Press the key ENTER for 0.1 to 2 seconds to enter the setting page of the selected function. At this time, the words of the selected function will be steady bright, and the value will blink on the left of the words of the selected function. Press QUERY KEY UP or DOWN for 0.1 to 2 seconds and select the value of the desired function parameter.
- Press the key ENTER for 0.1 to 2 seconds after turning the page to the desired function parameters. The function setting is completed. At this time, the value of the function parameters will be steady bright and no longer blink.

Press ESC key for more than 0.1 to 2 seconds to set the function successfully. At the same time, exit the function setting page and return to the main display page (you can also do nothing, and it will automatically turn back to the main display page after waiting for 30 seconds at most).

1.4.1 Output Voltage (OPU)

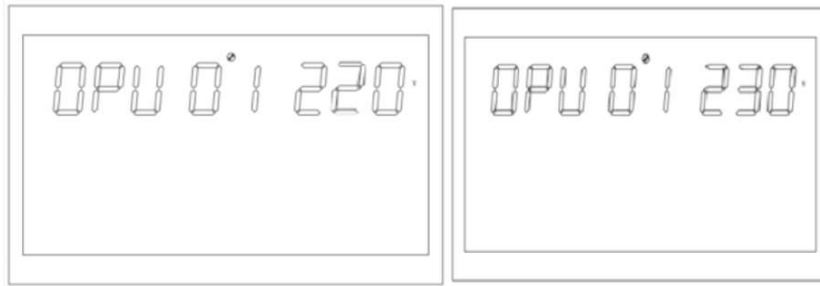

Figure 1-12 Setting the output voltage

- The default output voltage is 230V, 208V, 220V, 230V and 240V, which can be set for all working conditions and take effect immediately.
- Press the function setting key ENTER for more than 2 seconds to enter the function setting page. Press the query key UP or DOWN for 0.1 to 2 seconds to select the function. The word OPU flashes when turn the page to the setting page of output voltage OPU.
- Press the key ENTER for 0.1 to 2 seconds to enter the setting page of output voltage OPU. At this time, the word OPU will be steady bright and the value of OPU will blink on the right of the word OPU. Press the query key UP or DOWN for 0.1 to 2 seconds, and select different output voltage values. The available voltage values are 208V, 220V, 230V, and 240V. The output voltage is 230V by default. The Settings are saved in real time.
- Press the key ENTER for 0.1 to 2 seconds after turning the page to the desired output voltage value. The output voltage OPU is set. At this time, the value on the right side of OPU will be steady bright and no longer flicker.
- The function is set successfully after press ESC key for more than 0.1 to 2 seconds, then exit the function setting page, return to the main display page (If not operate, wait for maximum 30 seconds to automatically turn back to the main display page).

Note: The output voltage must be derated to 90% if the output voltage is set to 208V.

1.4.2 Setting Other Functions

1.4.2.1 Output Frequency (OPF)

The output frequency is set. The default value is 50Hz.



Figure 1-13 Setting the output frequency

Function description: Set the inverter output frequency. 50Hz and 60Hz can be set. The default value is 50Hz.

Setting conditions: All status can be set. In battery mode, the setting will take effect when the machine is restarted next time. The utility grid mode takes effect immediately. The frequency changes slowly after you switch it to battery mode.

1.4.2.2 Setting Output Priority (OPP)

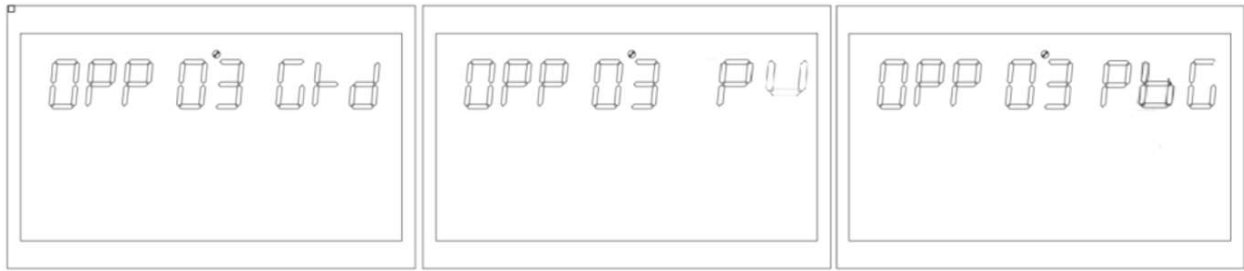

Figure 1-14 Setting the output priority page

Function description: Set the inverter output priority.

Setting conditions: All status can be set, and the setting takes effect immediately.

Note:

There are three options for the inverter output priority. The default output priority is GRD: The utility grid output is preferred. The second is PU(PV): photovoltaic output is preferred; The third is PBG: photovoltaic >battery >utility grid output.

1.4.2.3 Output Mode (MOD)

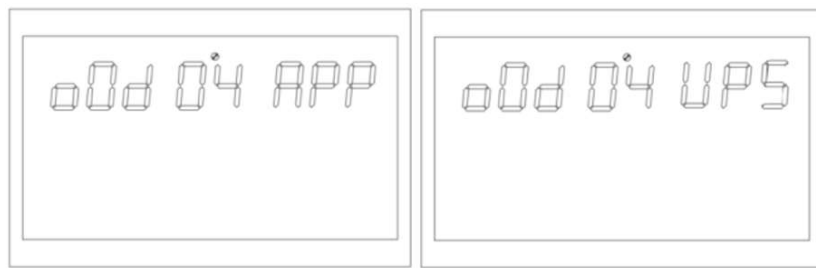

Figure 1-15 Setting the output mode

Function description: Set the inverter output mode.

Setting conditions: All status can be set and take effect immediately.

Description:

There are two options for AC output mode, the default mode is APP: Appliance, which is used for household appliances; The second is UPS mode, which is used for equipment such as computers. The typical switchover time is 10ms.

1.4.2.4 Charging Priority (CHP)





Figure 1-16 Setting the charging priority page

Function description: Set the charging priority of the inverter.

Setting conditions: All status can be set, and the Settings take effect immediately.

Description:

There are four charging priorities, the default priority is PNG (PV and Grid):PV charging and Grid charging are at the same time; The second is OPV(Only PV): Only PV charging; The third is GRD(Grid): the charging priority is utility grid; The fourth is PV: the charging priority is PV charging

1.4.2.5 Grid Charging Current (RCC)



Figure 1-17 Setting the grid maximum charging current

Function description: Set the grid maximum rechargeable current of the inverter.

Setting conditions: All status can be set.

Description:

RCC:The maximum charging current of grid is set to 30A by default, and the setting range is [1,80A]

1.4.2.6 Maximum Charging Current (MCC)

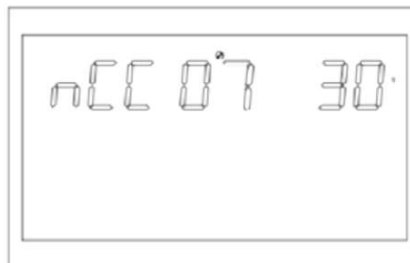

Figure 1-18 Setting the maximum charging current

Function description: Set the maximum charging current of the inverter.

Setting conditions: All status can be set.

Description:

MCC:Maximum Charge Current refers to the Maximum value of PV and grid charging current. It is optional (2/10/20/30/40/50/60/70/80A)

1.4.2.7 Menu Default (MDF)

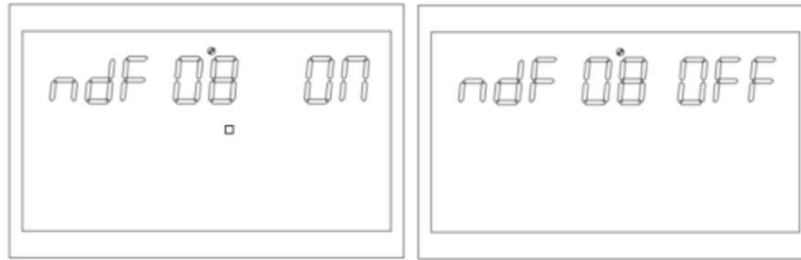

Figure 1-19 Returning to the Settings page

Function Description: Return to the main screen.

Setting conditions: All status can be set.

Description:

The default setting is ON. In the function setting operation, if it is set to ON, the page is not in the first interface (P1) at this time, and will return to the first interface after 1min; If this parameter is set to OFF, the LCD remains on this screen if the page is not in the first screen (P1).

1.4.2.8 Overload Restarting (LrS)

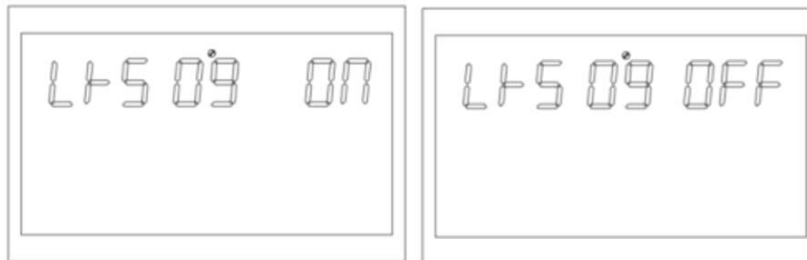

Figure 1-20 Setting the overload restart page

Function description: Set overload restart.

Setting conditions: All status can be set.

Description:

The default setting of overload restart is ON.

1.4.2.9 Over-temperature Restart (TrS)

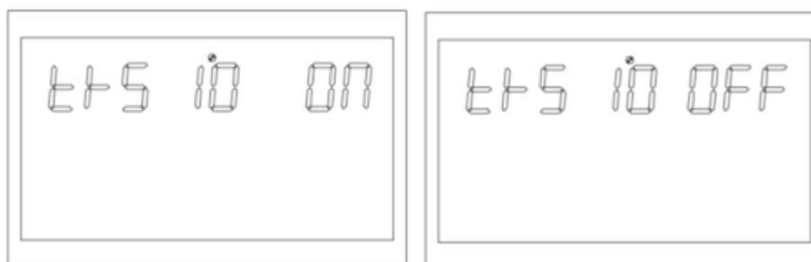

Figure 1-21 Setting the over-temperature restart page

Function description: Restart the system from over-temperature.

Setting conditions: All status can be set.

Description:

The default setting of over-temperature is ON.

1.4.2.10 Main Input Power Failure (MIP)

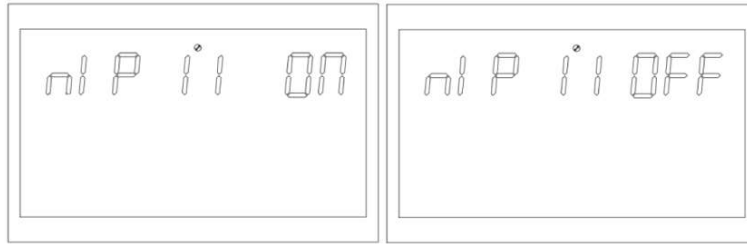

Figure 1-22 Setting the alarm page of main input power failure

Function description: Set the constant alarm for grid or PV loss.

Setting condition: All status can be set. The default status is ON. The grid or PV loss alarm keeps ringing for a period of time. You can set it to OFF. (All modes can be set)

Description:

MIP:Main Input cut warning

The default value is ON. The buzzer will ring for 3 seconds if the primary input detection is lost.

The buzzer does not sound frequently after the main input is lost when the parameter is set to OFF.

1.4.2.11 Energy Saving Mode (PWS)

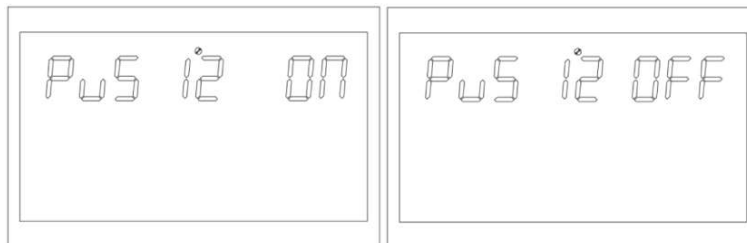

Figure 1-23 Setting the energy saving mode

Function description: Set whether to enable the low-power mode (energy saving mode) for the inverter.

Setting conditions: All status can be set.

Description:

PWS:Power Saving

The default value is OFF, and the function is disabled. In battery mode, the output of system will temporarily stop if the load is lower than 25W when this parameter is set to ON; The output will continue if the load is higher than 35W, and the output of system will resume normal.

1.4.2.12 Transition from Overload to Bypass Mode (OLG)

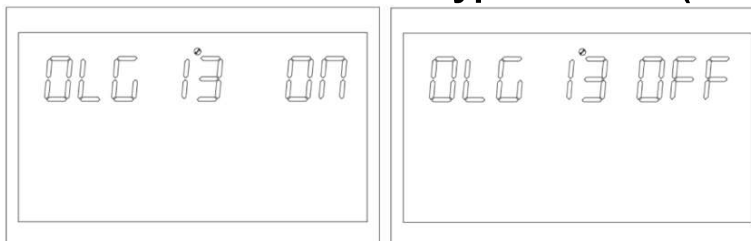

Figure 1-24 Setting the transition from overload to bypass mode

Function description: Set whether to switch to grid mode immediately (also known as bypass mode) when it is overloaded in battery mode.

Setting conditions: All status can be set.

Description:

OLG:Overload to Bypass

The default value is OFF, and the function is disabled. The system will immediately switch to bypass mode (grid output, that is, bypass mode) if the PV output is overloaded when the value is set to ON, .

1.4.2.13 Setting Mute (MUE)

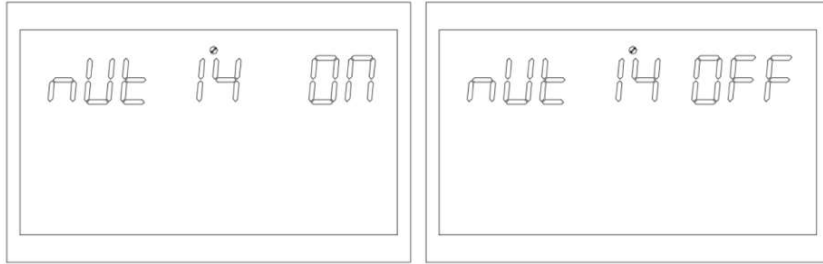

Figure 1-25 Setting the mute page

Function description: Sets whether the buzzer beeps.

Setting conditions: All status can be set.

Description:

MUE:Mute

The default value is OFF, and the Mute function is disabled. The buzzer does not sound in any state, such as alarm or fault when the parameter is set to ON.

It can be set in any modes, and the function is normal, but the picture can not be displayed.

1.4.2.14 Battery Return to Grid Voltage Point (BTG)

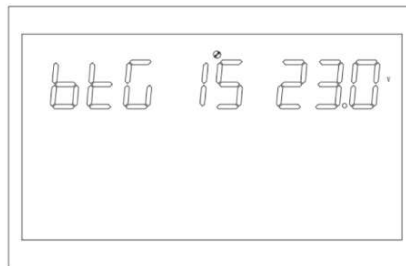

Figure 1-26 Switching the battery back to the grid voltage point

Function Description: It transfers to grid power supply only to ensure that the battery will not be empty when the battery and grid power supply at the same time and the battery discharging reaches a certain voltage.

Setting conditions: All status can be set, and the output priority must be set in PV and PBG mode.

Description:

BTG:Back To Grid

The default value is 46V

When the definition mode of battery is CUS(Customer Set Type) mode:

The range can be [44,52]

When the battery is AGM(lead-acid battery type) or FLD (water-injection battery type) :

The default value is 46V. The range can be [44,52].

When the battery is LIB (lithium battery type) :

The default value is 47.6V. The range can be [40,50].

Four battery types are set: AGM(lead-acid battery) is set as the default; The second is FLD(water injection battery); The third type is LIB (lithium battery); The fourth is CUS(Customer setting type)

1.4.2.15 Switching Back to Battery Mode Voltage Point (BTB)

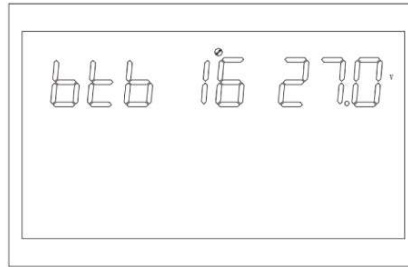

Figure 1-27 Setting the battery voltage point that let Grid mode switch back to battery mode

Function Description: It needs to reach a certain battery voltage value to restart the battery mode after shutdown for a low battery voltage.

Setting conditions: All status can be set.

Description:

BTB:Back To Battery

The default value is 52V

When it is set to FUL, the battery will be charged until it is fully charged before restarting in battery mode.

When the definition mode of battery is CUS(Customer Set Type) mode:

It can be set in the range of [48,58]

When the definition mode of battery is AGM(lead-acid battery type) or FLD (water-injection battery type) :

The default value is 52V. The range can be [48,58]

When the definition mode of battery is LIB (lithium battery type) :

The default setting is 54.4v, and the range can be set to [46,58]

1.4.2.16 Battery Type (BAT)



Figure 1-28 Battery type setting page

Function Description:Set the battery type.

Setting conditions: All status can be set.

Description:

BAT:Battery Type

1.4.2.17 Battery Low Voltage Point (bAL)

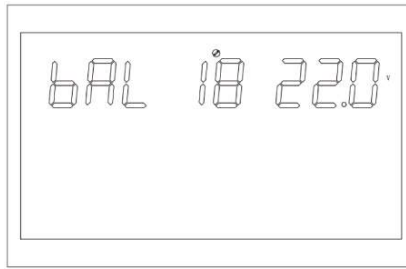

Figure 1-29 Setting the battery low voltage point

Function Description: Sets the low alarm point.

Setting conditions: All status can be set.

Description:

bAL:battery Low

This parameter cannot be set when the definition mode of battery is AGM(lead-acid battery type) or FLD (water-injection battery type).

The default value is 44V

The battery low voltage point can be modified when the battery type is set to CUS(Customer set type).

The value range is [42,54].

If the battery type is set to LIB(lithium battery type), you can change the battery low voltage point.

The default value is 47.6V, and the range is [41.2,50.0].

1.4.2.18 Battery Shutdown Point (bAU)

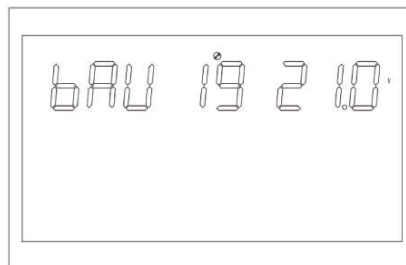

Figure 1-29 Setting the battery shutdown point

Function Description: Battery low voltage shutdown point setting.

Setting conditions: All status can be set.

Description:

bAU:battery Under

This parameter cannot be set when the battery definition mode is AGM(lead-acid battery type) or FLD (water-injection battery type).

The default value is 42V

The battery shutdown point can be modified when the battery type is set to CUS(Customer Setting type).

The value range is [40,48].

When the battery type is set to LIB(lithium battery type), you can change the battery shutdown point.

The default value is 46V. The value range is [40,48].

1.4.2.19 Setting Voltage Points in Constant Voltage Mode (bCV)

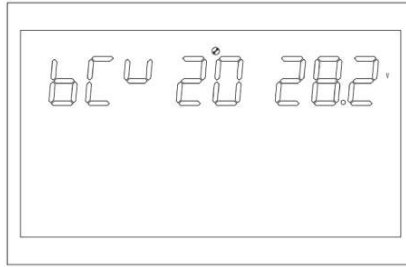

Figure 1-30 Setting the voltage point in constant voltage mode

Function Description: Constant voltage point setting.

Setting conditions: All status can be set.

Description:

bCV:battery Constant Voltage

This parameter cannot be set when the definition mode of battery is AGM(lead-acid battery type) or FLD (water-injection battery type).

Initial default Settings: 56.4V (AGM), 58V (FLD)

The constant voltage charging point can be modified when the battery type is set to CUS (Customer Setting type).

The value ranges from 48 to 60. The constant point voltage needs to be greater than the floating point voltage.

If the battery type is set to LIB(lithium battery type), the constant voltage charging point can be changed.

The default value is 56.4V and the value range is [48,60]. The constant point voltage needs to be greater than the floating point voltage.

1.4.2.20 Voltage Point Setting in Floating Charge Mode (bFL)

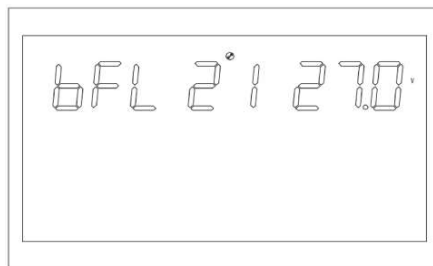

Figure 1-31 Setting voltage point in floating charge mode

Function Description: Constant voltage point setting.

Setting conditions: All status can be set.

Description:

bFL:battery Float

This parameter cannot be set when the definition mode of battery is AGM(lead-acid battery type) or FLD (water-injection battery type).

The default value is 54V

The battery type is set to CUS(Customer Setting Type) to modify the floating battery charge point. The value ranges from 48 to 60V. The constant point voltage needs to be greater than the floating point voltage.

If the battery type is set to LIB(lithium battery type), the constant voltage charging point can be changed.

The default value is 55.2V. The value range is [50,58]. The constant point voltage needs to be greater than the floating point voltage.

1.4.2.21 Low Voltage Point Setting of Grid (LLV)

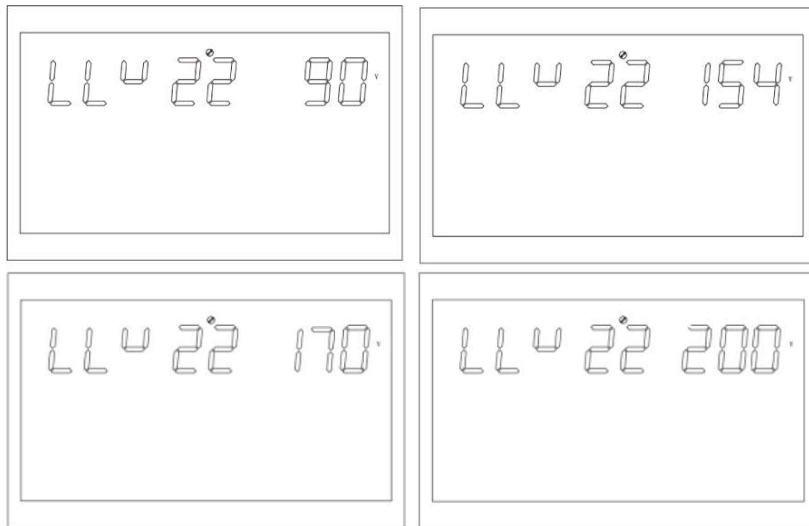

Figure 1-32 Setting the low-voltage point of grid in inverter mode

Function Description: Set the low voltage protection point of grid.

Setting conditions: The inverter is in APP and UPS mode, and all status can be set.

Description:

LLV:Line Low Voltage

Output mode: MOD needs to be set to APP, the default value of low voltage point of grid is 154V, and the range of setting is [90,154];

Output mode: MOD needs to be set to UPS, the default value is 185V, and the range is [170,200].

1.4.2.22 Setting High Voltage Point of Grid (LHV)



Figure 1-33 Setting high voltage point of grid

Function Description: Set the high voltage protection point of grid.

Setting conditions: The inverter is in APP mode, and all status can be set.

Description:

LHV:Line High Voltage

Output mode: MOD needs to be set to APP, the default value of high voltage point of grid is 264V, and the range is [264,280].

1.4.2.23 Setting Low Power Discharging Time (LWD)

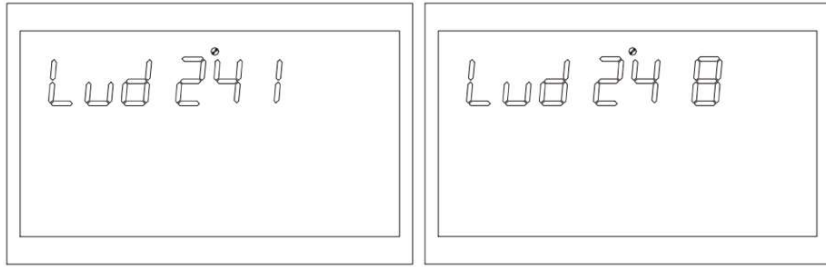

Figure 1-34 Setting the low-power discharging time

Function Description: LOW POWER DISCHARGING PROTECTION FUNCTION, IN BATTERY MODE, at a low load, unlimited time of discharging will make the battery very empty, affecting the battery life. In the setting time of low power amplifier of Inverter, the low voltage shutdown point of battery will be increased to 44V.

Setting conditions: All status can be set when the inverter is set in APP mode.

Description:

LWD:Low Watt Discharge

The default value of low-power discharging time is 8(8 hours), and the range can be [1, 8].

In battery mode, if not reached the battery shutdown point, the battery voltage shutdown point will be changed to 11V* number of batteries after the continuous discharging time of more than 8 hours. The system will alarm for 1 minute and then shut down when the battery is discharged to 11V* number of batteries.

The battery discharging time is reset when the battery voltage exceeds 13.2V x the number of batteries for more than 30s, .

1.4.2.24 Inverter Soft Start Setting (SRE)

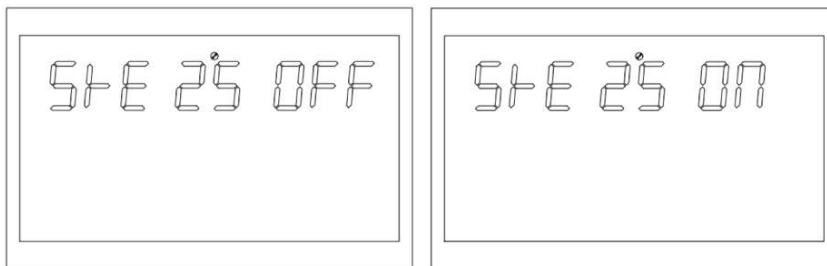

Figure 1-35 Setting the soft startup of the inverter

Function: The inverter output voltage gradually increases from 0 to the target value when the interface is in the ON state. The inverter output voltage is directly increased from 0 to the target value when the interface is in the OFF state.

Setting conditions: All status can be set.

Description:

SRE:Soft Relay Enable

If the default value is OFF, the output switch is turned to on only when the inverter voltage rises to the rated output. If this parameter is set to ON, the output switch is turned to ON before the inverter starts to boost voltage.

1.4.2.25 Setting Default Values (STD)

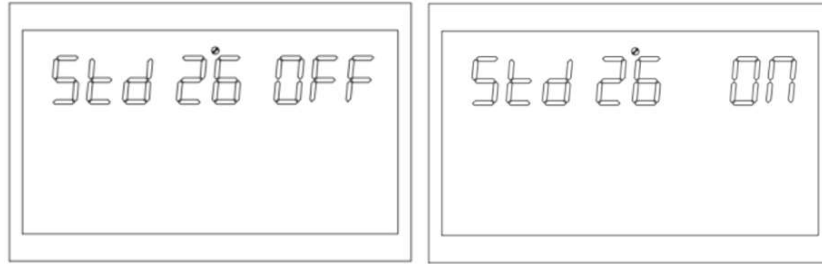

Figure 1-36 Setting default values

Restore all Settings to default values.

Setting conditions: This parameter can be set in grid mode or StandBy (StandBy: no output but the screen is on). It can not be set in battery mode.

Description:

STD:Set Default

Before the setting, the screen is displayed as OFF. The system restores the default setting when the screen is set to ON. After the setting is completed, the screen will display OFF again.

It can be set in grid and standby mode and take effect immediately. It can not be set in battery mode and pictures can not be displayed.

1.4.2.26 Setting Parallel Mode (PAM)

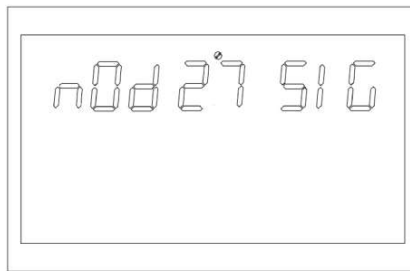

Figure 1-36 Setting default values

Set parallel working mode.

Setting conditions: This parameter can be set in grid mode or StandBy (StandBy: no output but the screen is on). It can not be set in battery mode.

Description:

PAM: Parallel operation mode.

The default single mode is SIG. But it can be set to parallel mode (PAR) : 3P1 (R phase), 3P2 (S phase) and 3P3 (T phase) .

To use the parallel function, firstly connect the parallel system in the correct way, and then set the parallel mode of each machine correctly. If there is one machine set to SIG in the parallel system, the machine reports fault 24. If there are machines set to 3P1, 3P2 and 3P3 in the parallel system, all machines must be set to one of the three modes and at least one machine exists in each mode; otherwise, all machines set to the three modes report fault 24.

It can be set in grid and standby mode and take effect immediately. It can not be set in battery mode and pictures can not be displayed.

1.4.2.27 Battery Missed (SBA)

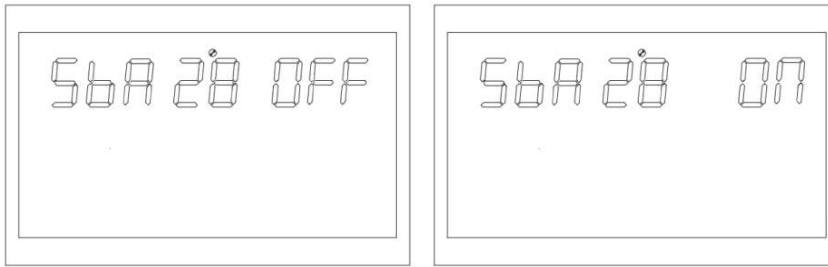

Figure 1-36 Setting default values

Function Description: Enable the unconnected battery alarm.

Setting conditions: All status can be set.

Description:

SBA:Set battery alarm.

The default setting is OFF.

If this parameter is set to OFF, no battery unconnected, battery low voltage, or battery undervoltage alarms will be generated when the battery is not connected.

1.4.2.28 Balancing Mode (EQM)

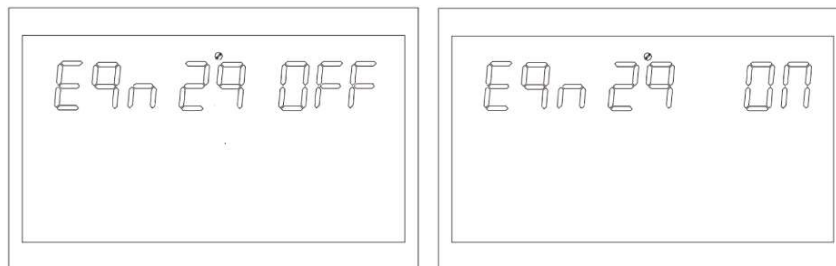

Figure 1-37 Setting the balancing mode

Function: Sets whether to enable the balance mode.

Setting conditions: All status can be set.

Description:

EQM:Equalization Mode

The default value is OFF, and the function is disabled. Set to ON, the controller will enter the equalization phase when the equalization interval (battery equalization cycle) set is achieved during the floating charging phase, or when the equalization is activated immediately.

1.4.2.29 Setting the Equalization Voltage Point (EQV)

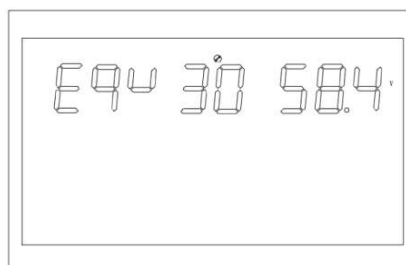

Figure 1-38 Setting the voltage balancing point

Function Description: Equalization voltage point setting function.

Setting conditions: All status can be set.

Description:

bCV:Equalization Voltage

All modes can be set.

The default value is 58.4V , and the value range is [48,60].

1.4.2.30 Setting Balanced Charging Time (EQT)

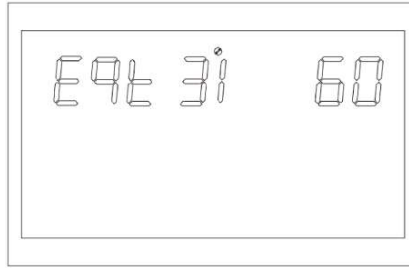

Figure 1-39 Setting the balanced charging time

Function Description: Balance charging time setting.

Setting conditions: All status can be set.

Description:

EQT:Equalization Time

In the equalization phase, the controller will charge the battery as much as possible until the battery voltage rises to the equalization voltage. Then constant voltage regulation is used to maintain the balanced voltage of the battery. The battery will remain in the equalization phase until the setting equalization time of battery is up.

The default value is 60 minutes. The value can be set in the range of [5,900], and the value can be set in increments of 5 minutes every time.

1.4.2.31 Setting the Balancing Delay (EQO)



Figure 1-40 Setting the delay balancing page

Function Description: Balancing delay charging time setting.

Setting conditions: All status can be set.

Description:

EQT:Equalization Timeout

In the equalization phase, the charging controller extends the battery equalization time until the battery voltage become balanced when the battery equalization time expires and the battery voltage does not rise to equalization voltage point. The charging controller stops equalization and returns to the floating charging phase when the battery equalization delay is completed and the battery voltage is still lower than the equalization voltage.

The default value is 120 minutes. The value can be set in the range [5,900], and the value can be set in increments of 5 minutes every time.

1.4.2.32 Setting the Balancing Interval (EQI)

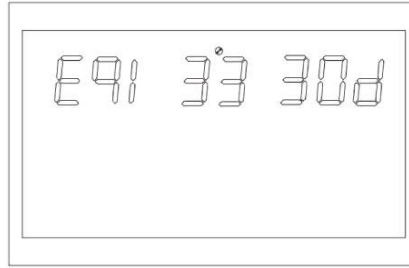

Figure 1-41 Setting the balancing interval

Function Description: Balanced charging interval setting.
Setting conditions: All status can be set.

Description:

EQI:Equalization interval

In the float charging stage with balanced mode enabled, if battery connection is detected and the setting equalization interval (battery equalization period) is reached, the controller start entering the equalization phase.

The default value is 30 days. The value range is [1,90], and the increments are 1 day every time.

1.4.2.33 Enabling Balancing Settings Immediately (EQN)



Figure 1-42 Start Balancing Settings Immediately page

Function: Set whether to enable the balancing mode for the inverter immediately.
Setting conditions: All status can be set.

Description:

EQN:Equalization Now

The default value is OFF, and the function is disabled. When set to ON, the equalization charging is activated immediately and the controller begins to enter the equalization phase when the battery is detected in the floating charging phase under the equalization mode.

1.4.2.34 Grid-connected inverter function (GTI)



Figure 1-43 Grid-connected inverter function setting page

Function description: Set whether the inverter is connected to the grid in PV priority mode or PBG mode.

Setting conditions: All status can be set.

Description:

GTI:Grid Tie Invert

The default setting is OFF, and the function is not turned on; The inverter supply the extra energy for grid by tracking the maximum power point when set to ON. After the function is turned on, an alarm 56 is generated, and the inverter no longer decides the operation logic according to the BMS information if the communication abnormality occurs.

* This function needs to be used together with the central centralized control board.

1.4.2.35 Battery dual-circuit output low-voltage shutdown point (DBV)

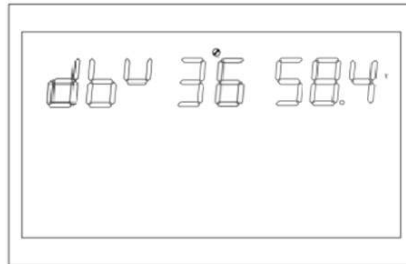

Figure 1-44 Dual-way output low-voltage shutdown point of Battery page

Function description: The secondary circuit output of inverter is turned on by default after turn the inverter on. The secondary output is closed when the battery voltage is lower than the shutdown point after entering the battery mode. The secondary output is turned on when the battery voltage is again higher than the setting value + 1V / section.

Set conditions: All status can be set.

Description:

DBV: Dual output cut-off voltage in battery mode

Dual output cut-off voltage in battery mode is set by default to 48V and can be set range [44,60] Take the constant voltage charging point as the recovery voltage when the setting point is higher than the constant voltage charging (CV) point-1V / section, .

* This function needs to be used together with a dual-way output auxiliary board.

1.4.2.36 Battery dual-output Duration (DBT)



Figure 1-45 Battery dual-way output low-voltage shutdown point page

Function description: The secondary circuit output of inverter is turned on by default after turn the inverter on. The secondary output is closed when the battery discharging time reaches the setting point after entering the battery mode.

Set conditions: All status can be set.

Description:

DBT: Dual output cut-off time in battery mode

The default setting is OFF, the function is not on, it can be set to [5,890] in minutes. The secondary output has unlimited output time when set to FUL, .

* This function needs to be used together with a dual-way output auxiliary board.

1.4.2.37 BMS communication function (BMS)

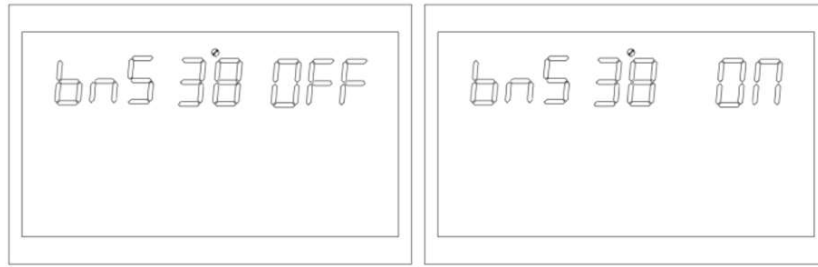

Figure 1-46 The B M S Management Function Settings page

Function description: Set whether the inverter communicates with the BMS of lithium battery.
Setting conditions: All status can be set.

Description:

BMS:Battery Management System

The default setting is OFF, and the function is not on; The inverter communicates with the BMS of lithium battery through the central control board, and receive the battery information when set to ON.

After the function is turned on, if the communication abnormality occurs, an alarm 56 is generated, and the inverter no longer decides the operation logic according to the BMS information.

- * This function needs to be used together with the central centralized control board.
- * This page is blocked when the central centralized control board is not accessed.

1.4.2.38 Low SOC shutdown function (BSU)



Figure 1-47 Low SOC Shutdown function setting page

Function description: Shutdown when low SOC is set.
Setting conditions: All status can be set.

Description:

BSU:Battery SOC under lock

The default value is 20, and the range can be set to [5,50]. In battery mode, shut down and call the alarm 68 when the lithium battery SOC reaches the setting point. Clear the alarm 68 when returning to the set value + 5%. In standby mode, it is necessary to reach the setting value+10% before switching to battery mode. An alarm 69 will be triggered if it is not reached. An alarm 69 will be triggered when the lithium battery SOC reaches the setting value + 5% after the function is turned on, and alarm 69 will be cleared when it returns to the setting value + 10%.

It can be set to OFF, and the inverter will no longer turn down, startup and alarm according to SOC.

After the function is turned on, the inverter will no longer decide the operation logic according to the SOC information, and clear the relevant alarms if an abnormal communication occurs.

- * This function needs to be used together with the central centralized control board.
- * The page is blocked when the central centralized control board is not accessed.

1.4.2.39 Set the SOC to turn to battery mode (STB)

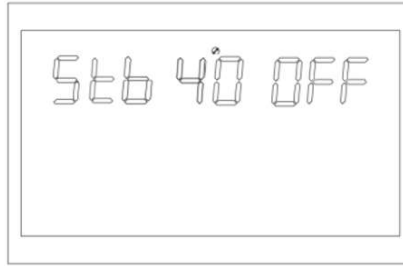

Figure 1-48 Set the SOC to turn to battery mode

Function description: Set the SOC value to turn to battery mode.

Set conditions: All status can be set

Description:

STB:Set the grid to battery mode.

The default setting is 90, and the range can be set to [10,100]. The inverter will switch to battery mode when the lithium battery SOC reaches the setting value If the PBG priority is set and the grid power is normal.

It can be set to OFF, and at this time the inverter will no longer switch to battery mode from grid mode according to the SOC situation.

The function is enabled, if an abnormal communication occurs, the inverter will no longer decide the operation logic according to the SOC information and clear the relevant alarm.

* This function needs to be used together with the central centralized control board.

* This option page is blocked when the central centralized control board is not accessed.

1.4.2.40 Set SOC to grid function (STG)



Figure 1-49 Set SOC to grid function setting page

Function description: Set the SOC value of inverter switching to grid mode.

Set conditions: All status can be set.

Description:

STG:Switch to grid mode when the battery SOC is low.

The default value is 50, and the range can be set to [10,90]. The inverter will switch to grid mode when the lithium battery SOC reaches the setting value If the PBG priority is set and the grid power is normal.

It can be set to OFF, and at this time the inverter will no longer switch to grid mode from battery mode according to the SOC situation.

The function is enabled, if an abnormal communication occurs, the inverter will no longer decide the operation logic according to the SOC information, and clear the relevant alarm.

* This function needs to be used together with the central centralized control board.

* This option page is blocked when the central centralized control board is not accessed.

1.5 Fault and Alarm Description

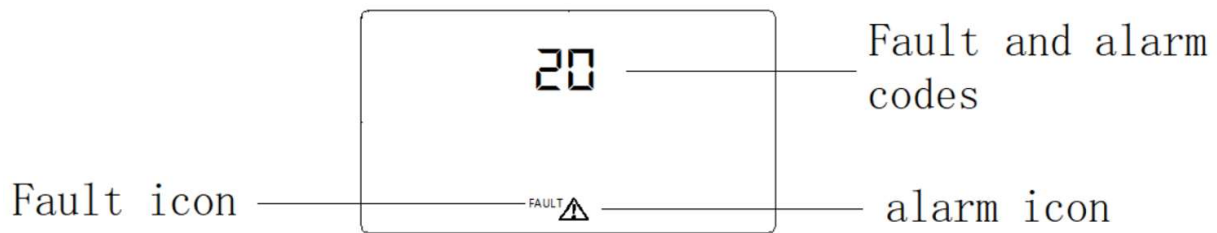

Figure 1-43 Fault and alarm ICONS

Function: The alarm code ALA blinks and the buzzer rings one time per second and last for 1 minute. The buzzer will ring for 10 seconds and stop if the fault indicator is steady on, and the fault will be eliminated after the buzzer ringing stops. It will remain in the fault state if you try to restart the inverter and fail to restart it for six times. You need to completely power it off (display distinguish) or wait for 30 minutes before you can restart the machine.

The fault and alarm on LCD display is shown as above figure. The fault icon is steady on in fault mode, and the alarm icon blinks in Alarm Status. Contact the manufacturer to rectify the fault.

1.5.1 Fault Description

- Fault: The inverter enters fault mode, the LED is steady red, and the LCD displays the fault code.

Table of fault codes

Fault code	Fault	Relevant action	The trigger condition	Restore conditions	The fault alarm
1	Bus soft start fail	Transfer to failure mode	The setting voltage can not be reached when the bus soft start	unrecoverable	The fault
2	Bus over voltage	Transfer to failure mode	The bus is above the setting value	unrecoverable	The fault
3	Bus low voltage	Transfer to failure mode	The bus is below the setting value	unrecoverable	The fault
4	Battery Over Current	Transfer to failure mode	The battery is immediately protected when the battery current exceeds 580A.	unrecoverable	The fault
5	Over temperature	Transfer to failure mode	The temperature of PFC or INV sensor is higher than the over-temperature setting point	Restart after this function is enabled, the system can not be recovered after three failed restarts	The fault
6	Battery over voltage	Transfer to failure mode	The battery voltage is above the setting value	unrecoverable	The fault
7	Bus soft Fault	Transfer to failure mode	The DC soft starting voltage of the bus does not reach the setting value	unrecoverable	The fault

8	Bus short Fault	Transfer to failure mode	The bus is below the setting value instantaneously when working normally.	unrecoverable	The fault
9	INV soft Fault	Transfer to failure mode	It still can not reach the rated output voltage after soft-starting the inverter for a period of time	unrecoverable	The fault
10	INV over voltage	Transfer to failure mode	In battery mode, the inverter voltage is higher than the setting value	unrecoverable	The fault
11	INV under voltage	Transfer to failure mode	In battery mode, the inverter voltage is lower than the setting value	unrecoverable	The fault
12	INV short circuit	Transfer to failure mode	The inverter voltage is lower than the setting value, and the current is higher than the setting value	It can not be recovered if a fault restart fails for six times	The fault
13	Negative power	Transfer to failure mode	The inverter power is less than the setting value for a period of time	unrecoverable	The fault
14	Overload fault	Transfer to failure mode	The load exceeds specifications	Restart After this function is enabled, the system can not be recovered after three failed restarts	The fault
15	Model Fault	Transfer to failure mode	The software identification machine model does not match the hardware detection	unrecoverable	The fault
16	No bootstrap program	Transfer to failure mode	No bootstrap	unrecoverable	The fault
17	PV program burning	Transfer to failure mode	Burning the PV control program	It will be restored after finishing burning	The fault
19	Same Serial No.	Transfer to failure mode	In parallel mode, multiple machines with the same serial number are detected	unrecoverable	The fault
20	CAN Fault	Transfer to failure mode	In parallel mode, the communication between the CAN and bus is abnormal	unrecoverable	The fault
21	BAT Volt Different	Transfer to failure mode	In parallel mode, the battery voltage value of different machines is too different	unrecoverable	The fault

22	Input Volt Different	Transfer to failure mode	In parallel mode, the input voltage value of different machines is too different	unrecoverable	The fault
23	Input Freq Different	Transfer to failure mode	In parallel mode, the input voltage frequency of different machines is too different.	unrecoverable	The fault
24	Output Setting Different	Transfer to failure mode	In the three-phase parallel mode, there is phase deficiency in the parallel mode Settings of different machines	unrecoverable	The fault
25	Output out of sync	Transfer to failure mode	In parallel mode, the output voltage detection is out of sync	unrecoverable	The fault
26	BMS Fault	Transfer to failure mode	The battery BMS has fault information	Turn off the BMS communication function, or eliminate the BMS faults and restore it	The fault

1.5.2 Alarm Description

► Alarm: The inverter is not in fault mode, the LED blinks red, and the LCD displays the alarm code.

The alarm code	Alarm	Relevant action	The trigger condition	Restore conditions	The fault alarm
50	Battery Disconnected	Alarm: The battery is not charged	The battery voltage is lower than 8V/ node	Recoverable (10V/ knot)	The alarm
51	Battery low voltage and shutdown	Alarm: Low battery voltage to shutdown or no startup	Battery voltage lower than 10.5V/ node (default)	Recoverable (10V/ node +0.2* N (number of batteries))	The alarm
52	Battery low voltage	The alarm	Depending on bAL Settings	Recoverable (action point +0.2V/ knot)	The alarm
53	Battery charger short circuit	Alarm: The battery is not charged	The battery voltage is lower than 5V and the charging current is higher than 4A	unrecoverable	The alarm
54	Low power discharge	Alarm	Battery discharging time exceeds the setting time of low-power discharging	Recoverable (battery voltage above 13.2V/)	The alarm
55	Over charge	Alarm: The battery is not charged	The battery voltage is higher than the setting value	Recoverable	The alarm

56	BMS Loss	Alarm, lock in standby mode	Communication has failed after the BMS communication function is turned on	Recoverable	The alarm
57	Over Temperature	Alarm: The battery is not charged	The temperature of PFC or INV sensor is higher than the setting value	The temperature of PFC or INV sensor is lower than the setting value	The alarm
58	Fan Fault	Alarm: One fan is faulty and another fan is working at full speed	No fan speed signal is detected.	Recoverable	The alarm
59	EEPROM fail	The alarm	EEPROM read/write fails.	unrecoverable	The alarm
60	Overload	Alarm: The battery is not charged	Load > 102%	Recoverable (load <97%)	The alarm
61	Abnormal generator waveform	Alarm, continue to work in battery mode	Generator waveform detection is abnormal	Recoverable	The alarm
62	PV Energy Weak	Shut down PV output and charge	The bus voltage is lower than the setting value when the battery is not connected.	Recover after 10 minutes	The alarm
63	Synchronization signal fail	Alarm, transfer to fault mode	The parallel board is disconnected	Switch to single machine mode or eliminate the disconnecting fault	The alarm
64	Parallel configuration incompatible	Alarm: Switch to standby mode	There is a missing phase when the three phase is combined	The three phases are restored when the setting are correct	The alarm
65	Parallel version incompatible	Alarm: Switch to standby mode	The parallel system has incompatible version number.	Restore when all machine versions in a parallel system are compatible with each other	The alarm
66	Parallel Communication Fault	Alarm: Switch to standby mode	Slave machine can not be detected in parallel system	The slave machine is detected in the parallel system, or the single-machine mode is set.	The alarm

67	Different in grid power supply under parallel operation	The alarm	Excessive error in grid voltage or frequency of each machine under parallel operation	Restore when detecting reasonable errors in the grid voltage and frequency of each machine	The alarm
68	Low SOC to shut down	Alarm, turn to standby mode	Lithium battery SOC is below the setting value	Turn off the shutdown function of low SOC, or turn off the BMS communication function, or recover when the SOC returns to the Setting value + 5%	The alarm
69	Low SOC	Alarm, Maintain shutdown status if in standby mode	Lithium battery SOC is below setting value+ 5% (grid or battery mode) or below setting value + 10% (standby mode)	Turn off the shutdown function of low SOC , or turn off the BMS communication function, or recover when the SOC returns to Setting value + 10%	The alarm

Specifications

Table 1 Line Mode Specifications

INVERTER MODEL	5000TL	10000TL
Input Voltage Waveform	Input Voltage Waveform	
Nominal Input Voltage	230Vac	
Low Loss Voltage	185Vac (UPS); 90Vac (Appliances)	
Low Loss Return Voltage	185ac+10V (UPS);90+10V (Appliances)	
High Loss Return	264ac-10V (UPS);280-10V (Appliances)	
Nominal Input	50Hz / 60Hz (Auto detection)	
Low Loss Frequency	40±1 Hz	
Low Loss Return	42±1 Hz	
High Loss Frequency	70±1 Hz	
High Loss Return	65±1 Hz	
Output Short Circuit Protection	Circuit Breaker	
Efficiency (Line Mode)	>95% (Rated R load, battery full charged)	
Transfer Time	10ms typical, 20ms Max@ Single <30ms @ Parallel	
Output power derating: The output power will be derated when AC input voltage drops to 170V.	<p>The graph illustrates the output power derating characteristics. The output power is zero for input voltages below 90V. At 90V, the power begins to rise linearly, reaching the Rated Power at 170V. The power remains constant at the Rated Power level until the input voltage reaches 280V, after which it drops to zero.</p>	

Table 2 Inverter Mode Specifications

INVERTER MODEL	5000TL	10000TL
Rated Output Power	5KVA/5KW	10KVA/10KW
Output Voltage Waveform	Pure Sine Wave	
Output Voltage Regulation	230Vac±3%	
Output Frequenc	50Hz/60Hz	
Nominal Output Current	21.7A	43.4A
Peak Efficiency	>93%	
Overload Protection	5s@>150% load; 10s@110%~150% load	
Surge Capacity	2* rated power for 0.5 seconds	
Nominal DC Input Voltage	48Vdc	
Cold Start Voltage(Lead-Acid Mode)	48Vdc	
Cold Start SOC(Li Mode)	Default 30%, Low DC Cut-off SOC +5%	
Low DC Warning Voltage (Lead-Acid Mode)	44.0Vdc	
Low DC Warning Return Voltage (Lead-Acid Mode)	46.0Vdc	
Low DC Cut-off Voltage (Lead-Acid Mode)	42.0Vdc	
Low DC Warning SOC (Li Mode)	Low DC Cut-off SOC +5%	
Low DC Warning Return SOC (Li Mode)	Low DC Cut-off SOC +10%	
Low DC Cut-off SOC(Li Mode)	Default 20%, 5%~50% settable	
High DC Recovery Voltage	58Vdc (C.V. charging voltage)	
High DC Cut-off Voltage	64Vdc	
No Load Power Consumption	<60W	

Table 3 Charging Mode Specifications

INVERTER MODEL		5000TL	10000TL
Utility Charging Mode			
Charging Algorithm		3-Step	
Max. AC Charging Current		80Amp(@V _{1/P} =230Vac)	160Amp(@V _{1/P} =230Vac)
Bulk Charging Voltage	Flooded Battery	58Vdc	
	AGM / Gel Battery	56.4Vdc	
Floating Charging Voltage		54Vdc	
Charging Curve			
MPPT Solar Charging Mode			
Max. PV Array Power		5500W	5500W x 2
Max. PV Input Current		18A	18A x 2
Start-up Voltage		150Vdc±10Vdc	
PV Array MPPT Voltage Range		120Vdc~430Vdc	120Vdc~430Vdc x 2
Max. PV Array Open Circuit Voltage		450Vdc	450Vdc x 2
Max. PV Charging Current		80A	80A x 2
Max. Charging Current (AC Charger Plus Solar Charger)		80A	160A

Table 4 General Specifications

INVERTER MODEL	5000TL	10000TL
Operating Temperature Range	0°C ~40 °C	
Storage temperature	-10°C~ 60 °C	
Humidity	5% to 95% Relative Humidity (Non-condensing)	
Altitude	<2000m	
Dimension(D*W*H)mm	220x483x460mm	590x690x210mm
Net Weight, kg	22.6Kg	29±0.5Kg