



# Electronic Automatic Focuser

## Detailed Installation and Operations Manual



苏州振旺光电有限公司

Suzhou ZWO Co.,Ltd.

*Thank you for purchasing the ZWO EAF. This guide will give you a brief introduction to the installation of your new Electronic Automatic Focuser. Please take the time to read it thoroughly and if you have any other questions, feel free to contact our support team at [info@zwoptical.com](mailto:info@zwoptical.com)*

---

# Catalogue

Electronic Automatic Focuser .....	1
Detailed Installation and Operations Manual .....	1
1. Welcome to Your New Focuser Experience .....	2
2. Product Description.....	3
3. EAF Specifications.....	5
4. Installation.....	6
5. Dimensions .....	7
6. Connecting your EAF.....	9
7. Software Installation and Configuration .....	12
8. Connecting EAF to your Astronomy Software.....	13
ASISudio .....	13
ASIAIR .....	14
SharpCap .....	18
FireCapture.....	19
Sequence Generator Pro .....	20
Maxim DL Pro .....	20
Nebulosity .....	21
The SkyX .....	21
9. Manual/Automatical Focus Control .....	23
ASISudio.....	24
ASIAIR.....	29
Sequence Generator Pro .....	29
FocusMax .....	32
Measuring the Focuser Backlash.....	37
10. Warranty and Return Policy .....	38

## 1. Welcome to Your New Focuser Experience

The EAF is a high quality Electronic Automatic Focuser (EAF) designed to suit a wide range of Optical Tube Assemblies (OTA). It is supplied with a versatile mounting bracket system suitable for flexible installation across a wide range of telescope focuser systems.

## 2. Product Description

The ZWO EAF is an all metal bodied electronic focus drive system designed for installation across a wide range of Optical Tube Assemblies. The flexible mounting system allows installation across refractors, Newtonians, Cassegrain and many other telescope designs. The accessories coming with the box offer a quick and simple installation using the supplied hardware and wrenches.

Finished in an attractive red anodised finish, the EAF's original design will grace any telescope. The EAF logo uses the Airy spot as an embellishment to reflect its precise focusing performance.

The EAF utilises a 35mm stepper motor which is subdivided into 5760 steps capable of being accurately positioned at any angle.



---

## Features (Standard Version)

- **High quality metal focuser** with anodized finish.
- **Precise focus control** for planetary and deep sky imaging.
- Can be used in both **autofocus and manual modes**.
- **Flexible installation** for use on a variety of refractors, Newtonians, schmidt cassegrain and other Optical Tube Assemblies.
- **Versatile mounting bracket system** with other adapters available for purchase.
- **ASCOM/INDI compatible drivers** available for download – interfaces with many well-known astronomy software packages.
- **ASICAP support** built in.
- **Native support in ASIAIR**.
- Integrated **USB interface**.
- Powered by USB 2.0 cable.

## Features (Advanced Version)

In addition to the features of the Standard version, the Advanced version offers:

- Temperature sensor
- Hand controller

## Supplied Accessories

## EAF Standard Version Package List



1. **EAF Body** contains the focuser motor and controller.
2. **Motor Bracket** for attaching the body to the OTA focuser assembly.
3. **Flexible Coupling** to attach the focus motor shaft to the OTA focuser drive shaft.
4. **Mounting Hardware** – Spacers and screws to mount the focuser body.
5. **M4 and M5 Wrenches** for secure the shaft locking screws and bracket hex screws.
6. **USB 2.0 Cable** – connection of computers or ASIAIR to the focus controller.

### 3. EAF Specifications

<b>Construction Material</b>	All metal, red anodised finish
<b>Motor Specification</b>	35mm Stepper Motor
<b>Subdivision Steps</b>	5760 steps
<b>Torque</b>	1.5N/M
<b>Focuser Payload Limit</b>	5KG



<b>Power/Data Interface</b>	USB 2.0
<b>Sensor/Hand Controller Interface</b>	3.5mm audio, Centre Positive

The ZWO EAF utilises a USB2.0 interface for data communication which supports ASCOM and can be used in association with a wide variety of astronomy software.

Planetary imagers can use ZWO's ASICAP or other third-party software packages such as Sharpcap, FireCapture.

Deep sky astrophotographers can enjoy support from ZWO's ASIAIR or other well known packages such as Maxim DL, The SkyX, Sequence Generator Pro, Nebulosity and many more. Third party focus software such as FocusMax, is also supported.

Your EAF is also fitted with a small multi-function interface that supports a temperature sensor or external hand controller.

A dedicated temperature sensor can be connected to collect temperature data and allow focuser control from your chosen software. The hand controller allows for manual control of focuser position and focus motor speed.

## 4. Installation

Your EAF is supplied with a bracket for connection to a wide variety of focusers. The standard bracket supports:

SkyWatcher Astrophotography Reflectors, SkyWatcher Black Diamond, SkyWatcher Dobsonians, SkyWatcher Maksutov-Newtonians.  
TS Optics,  
Astro Tech,  
Feather Touch,

---

SharpStar telescopes,  
SkyRover telescopes,  
Explore Scientific telescopes  
.....

We recommend you refer to this instruction to confirm whether your telescopes and focusers are compatible to EAF.

<https://www.yuque.com/zwopkb/hardware/eaf-support-list#G2tSm>

You can also check the mechanical drawing below to estimate the compatibility by yourself.

A range of brackets for other telescopes are going to be available with time. Please keep your eyes on the ZWO site.

## 5. Dimensions

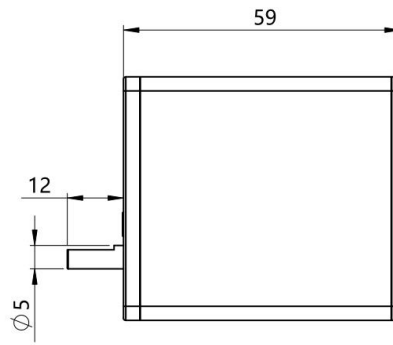
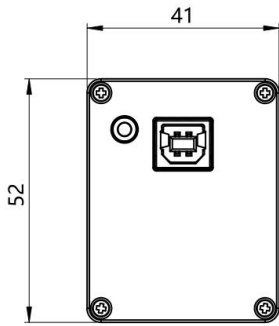

Unit:mm  
单位:毫米

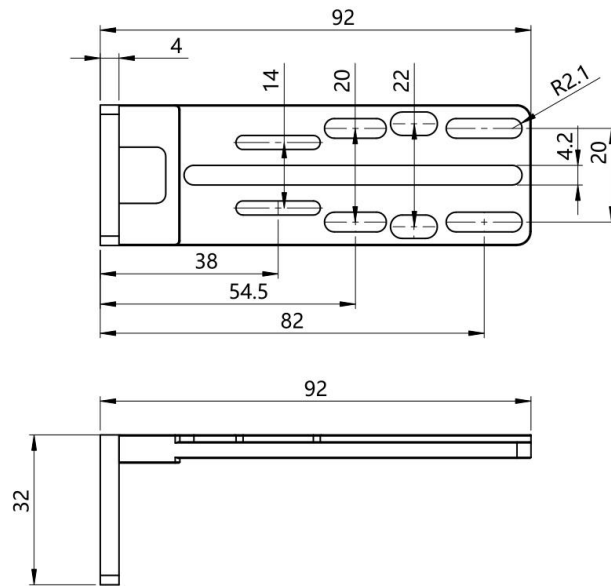
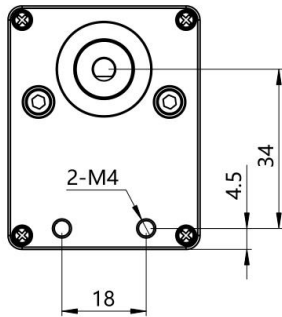



## 6. Connecting your EAF



Remove the coarse adjustment knob of the telescope focuser with a suitable sized wrench.



Install the flexible coupling on the telescope focuser shaft and tighten the lock screw.



Attach the bracket to the focuser and then fix it to the EAF body with the screws.



Attach the bracket to the focuser and then fix it to the EAF body with the screws.

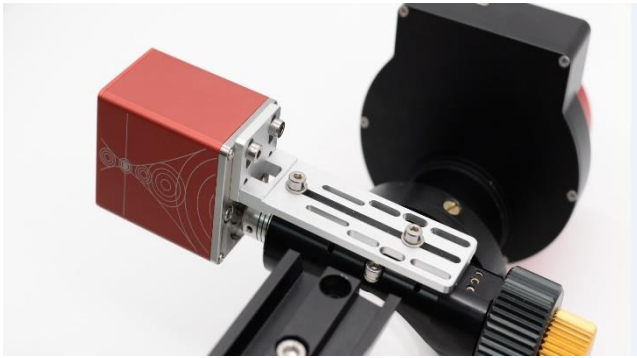

Check whether the installation is robust.



Connect the EAF to the ASIAIR/ computer/cooled camera, hand controller or the temperature sensor.



For curved focusing seats, such as those on the Sharpstar and the Feathertouch focusers, you only need use the original locking screws and 3 spacers to fix the EAF. There are grooves on the bottom of the EAF connecting plate, and the single screw provides sufficient stability.



Please also note that when fixing the EAF body to the flexible coupling, you need to align the holes to the flat side of the bearing inside of the arc side. Wrong connection way may lead to the abrasion of the bearing.

# 7. Software Installation and Configuration

## ASCOM Installation

The latest version of ASISudio has native support for the EAF. Other software packages will require the use of an ASCOM driver. EAF ASCOM drivers can be found on the ZWO website:

<https://astronomy-imaging-camera.com/software-drivers>

ASCOM Drivers (optional)				
ASCOM Platform	After installing the ASCOM Platform, please install below ASCOM drivers, then you can use many 3rd party astro software through ASCOM. <b>Note:</b> This software is not from ZWO, we just provide another download node. <a href="#">Official Site</a>	v6.5	Released 11/20/2020	<a href="#">Download</a>
ASCOM	ASCOM driver to support ASI Cameras, EAF, EFW and USBT4.	v6.5.1.4 <a href="#">Change Log</a>	Released 3/1/2021	<a href="#">Download</a>

Download and install the ASCOM driver and launch the EAF dashboard from within your astronomy software.

The screenshot shows the ZWO EAF Setup V1.0.1.7 (FW: 3.1.3) window. It features a ZWO logo, a dropdown menu for 'EAF (ID0)', a temperature display 'T: 31.9C', and a 'Current position: 4000' with a 'Set zero' button. A 'Target position: 4000' field is highlighted with a red box and a 'Move' button. Below this are 'IN' and 'OUT' buttons with a '10' value between them. Further down are 'Max Step: 10000', 'Backlash: 66', and a 'Beep' checkbox. The window also has 'Advanced' and 'Reverse' checkboxes checked. Callout boxes provide the following explanations:

- Reverse the motor:** Points to the 'Reverse' checkbox.
- Driver version:** Points to the top of the window.
- Temperature:** Points to the 'T: 31.9C' display.
- Edit current position: usually to set zero position:** Points to the 'Current position: 4000' and 'Set zero' button.
- GOTO an absolute position:** Points to the 'Target position: 4000' and 'Move' button.
- Manual control:** Points to the 'IN', '10', and 'OUT' buttons.
- Max steps: Limit travel range of the focuser:** Points to the 'Max Step: 10000' field.
- Backlash: the accuracy backlash of the EAF, if you set backlash in capture software, recommend to set 0 here. How to measure the backlash, read Appendix I.** Points to the 'Backlash: 66' field.
- Every time the motor rotates, there will be a sound prompt:** Points to the 'Beep' checkbox.
- Advanced settings, including more settings:** Points to the 'Advanced' checkbox.

## 8. Connecting EAF to your Astronomy Software

### Software

#### ASISStudio

Take ASICap for example:

1. Open the focuser control panel.

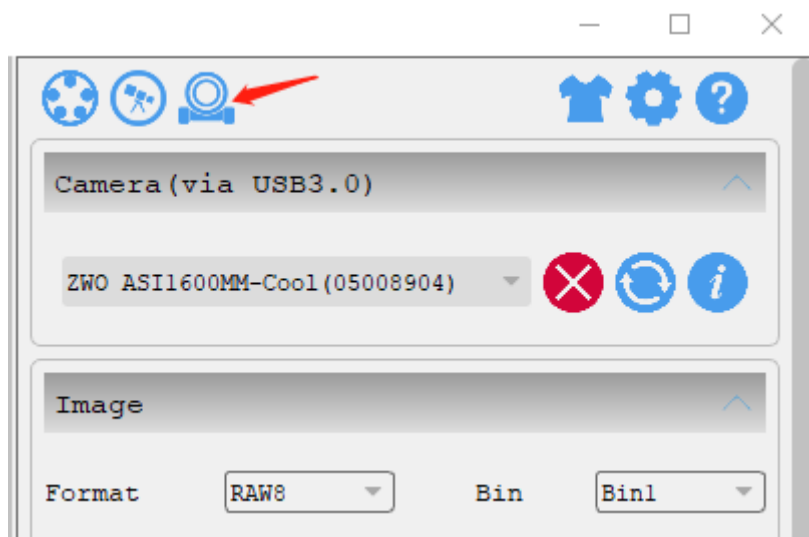

2. choose the focuser that you connected.

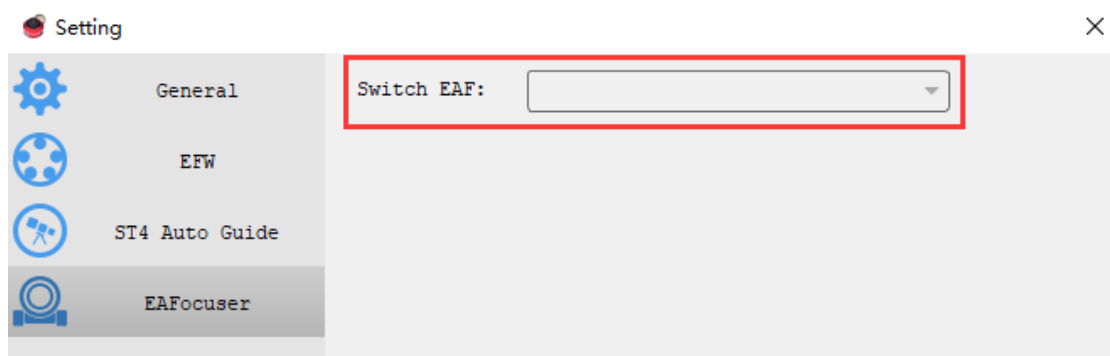

3. Set suitable settings for your EAF.

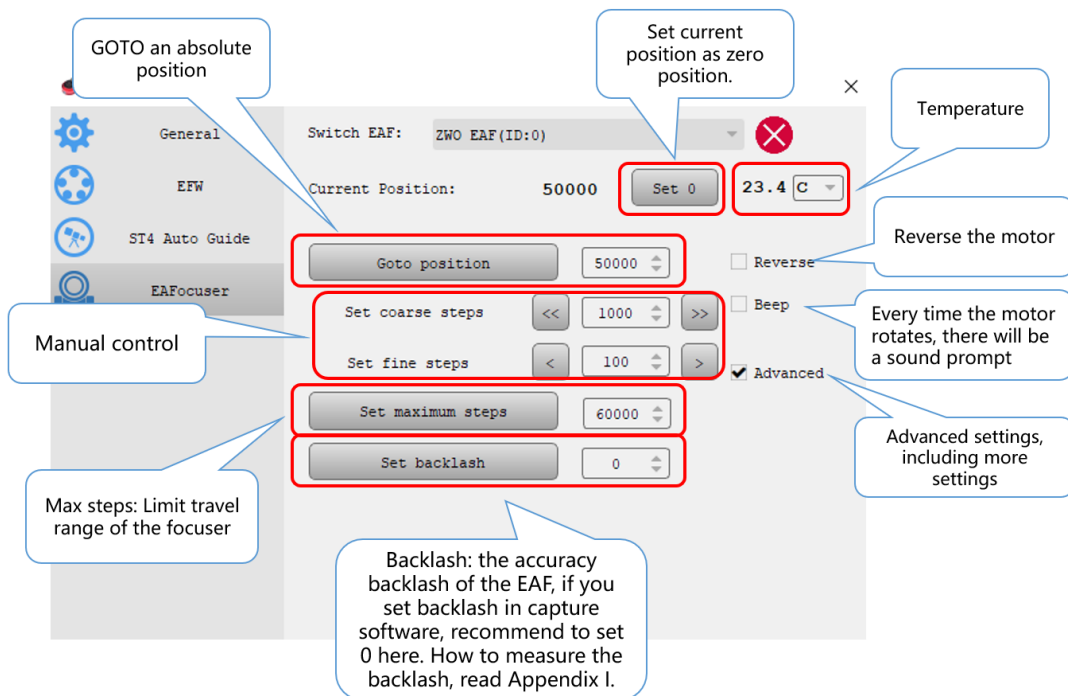

## ASI AIR

The newest ASI AIR App version supports Manual Focus and Auto Focus.

1. Tap the Focuser icon on the top navigation bar to enter the Focuser Settings page.

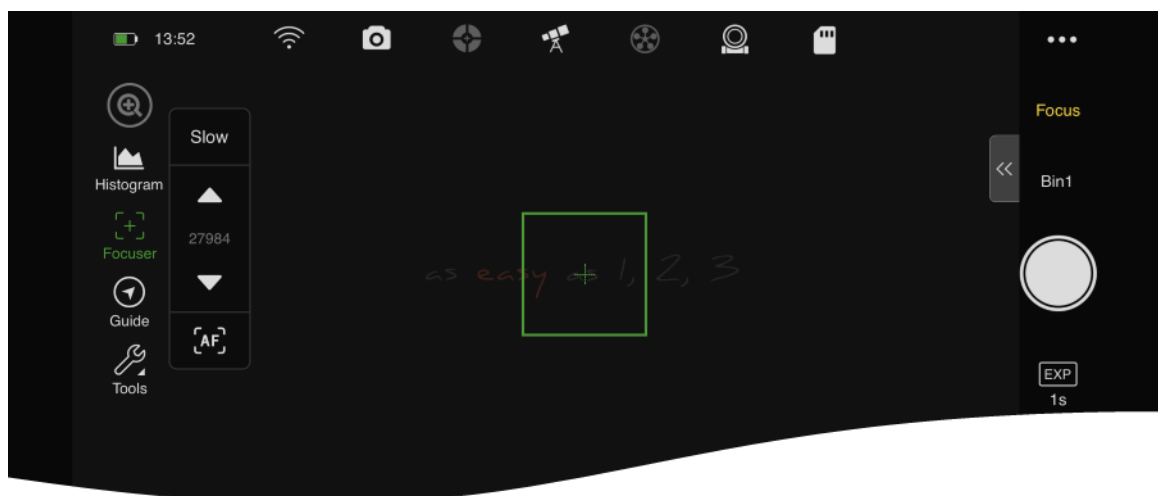

## 2. Manual Focus Settings

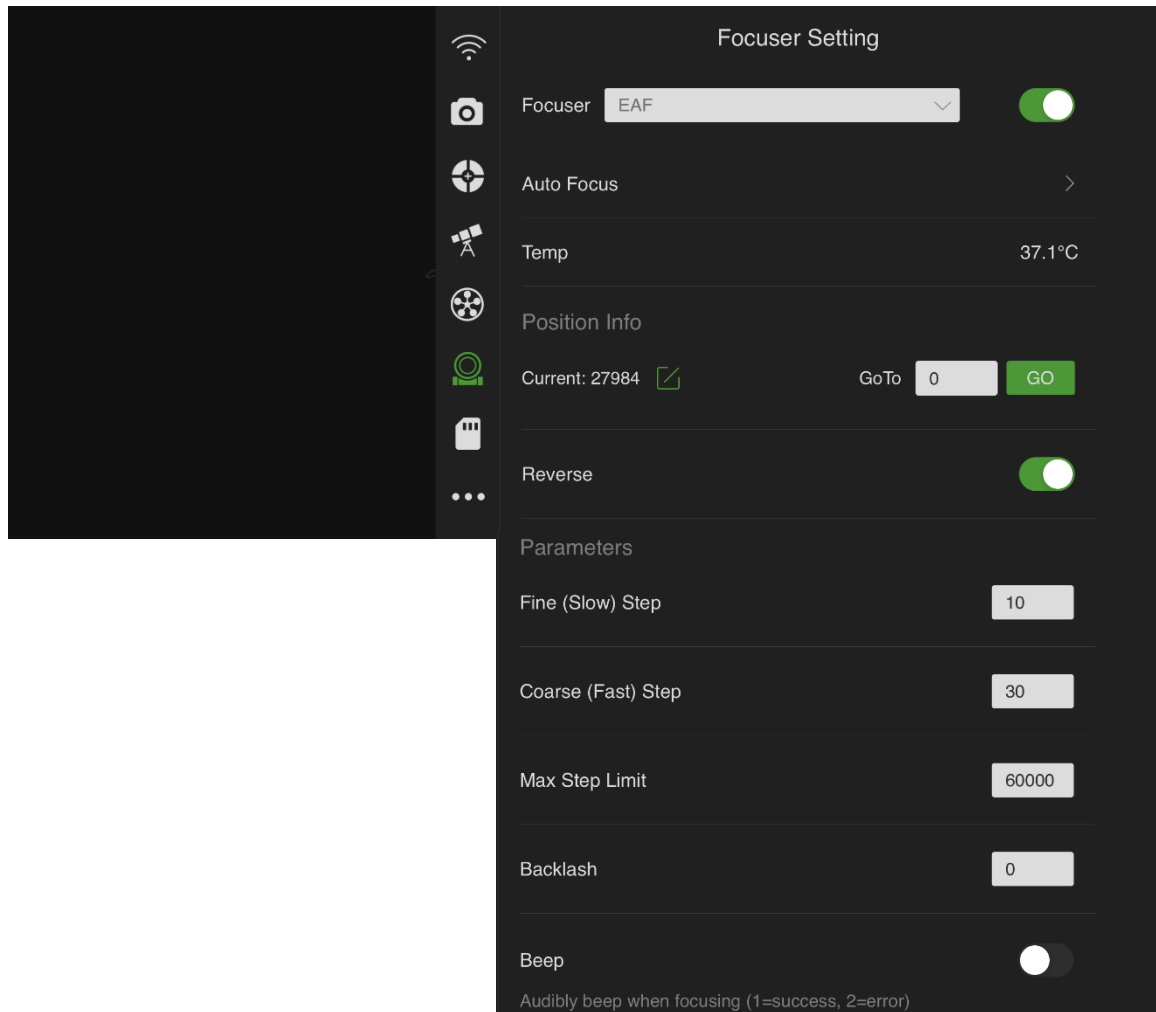

There are three types of settings,

### 1) Info Display

**Temp** shows the environmental temperature in Celsius format with an extra Temperature Sensor (comes with the ZWO-EAF-A kit), or the EAF inner temperature without one.

**Position Info > Current** shows the EAF stepper count of the current position based on the last ZERO position. Also, you can do a position GoTo here.

## 2) Action Settings

**GoTo**, see above.

**Reverse**, turning it on means make the EAF Motor rotates in the reverse direction based on the current direction.

## 3) Parameters



Tap the Focuser icon in the left Auxiliary Tools area to show the Focus Control Pad, switch the move step size which is set in the Fine (Slow) Step and Coarse (Fast) Step options by tapping the text button 'Slow'/'Fast'.

**Max Step Limit**, the max step that the EAF can move, which is based on your telescope focuser and has the upper limit of 60,000. Recommended to set it to 60,000 by default.

**Backlash**, see 12 section of this document to measure.

**Beep**, make a sound which is described as the tip text tells after the EAF moved.



### 3. Auto Focus

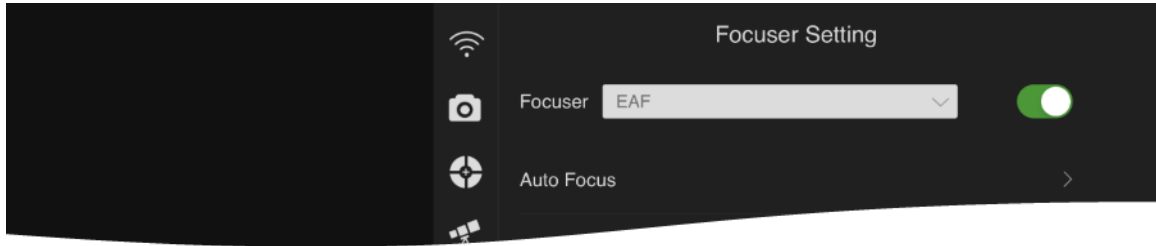

Tap the 'Next' icon (>) to enter the **Auto Focus Settings**.

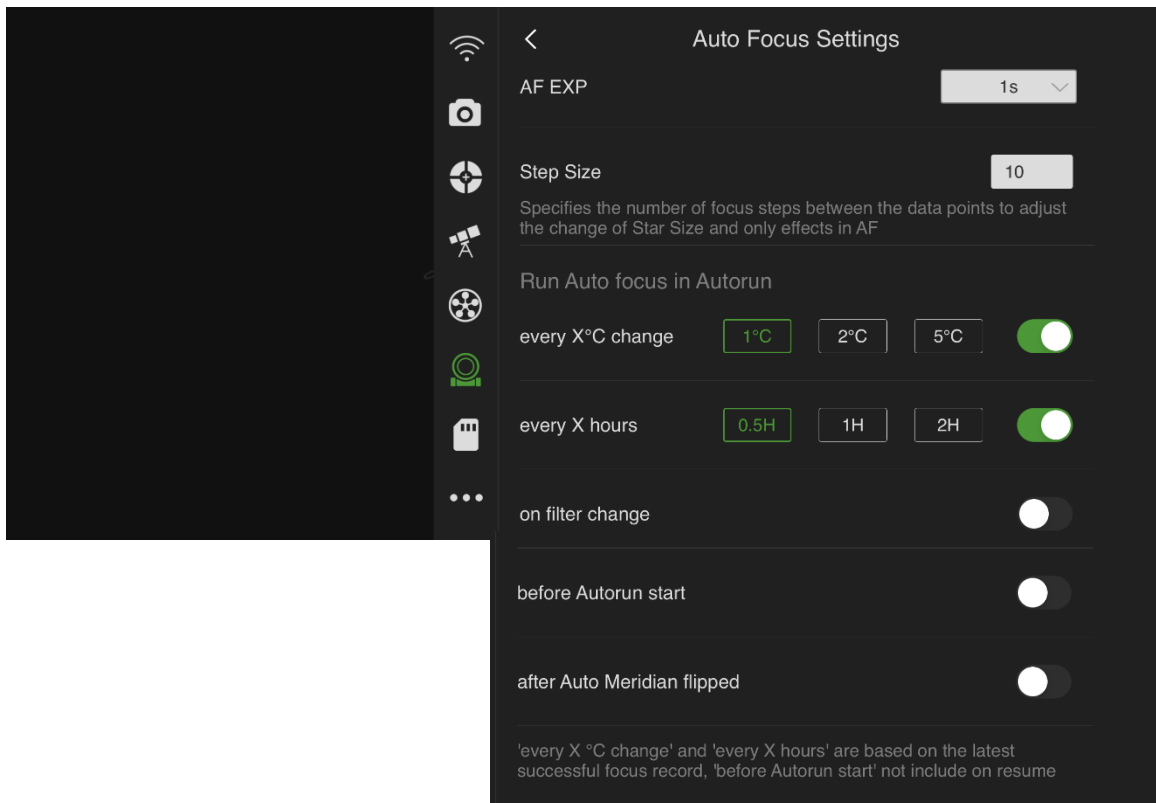

**All the settings** have the meanings as the title or the tip text tells.

**AF EXP**, here the value is a common setting if there is no ZWO EFW is connected and only effects while AF is enabled in Autorun mode. If a ZWO EFW is connected, go to the EFW Settings page to set different AF EXP for each filter.

AF has two trigger ways, **manually** or **automatically**. AF runs automatically in the Autorun progress if any of the options are enabled in the above settings.

Trigger it manually by tapping the AF icon on the **Focus Control Pad**.

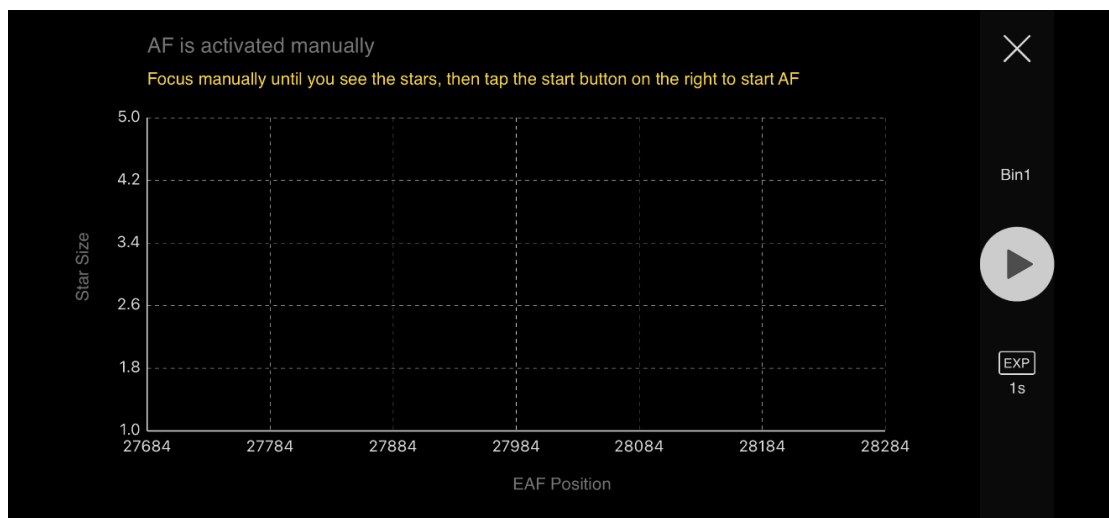

## Sharpcap

1. Open Sharpcap settings.

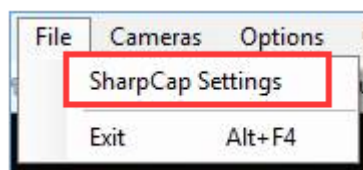

2. Choose ZWO focuser.

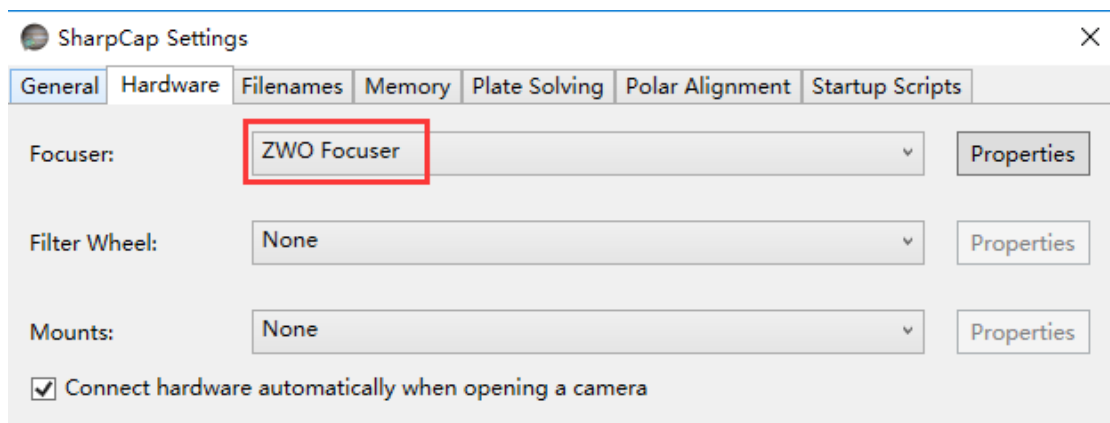

## FireCapture

1. Open the focuser panel in settings menu.

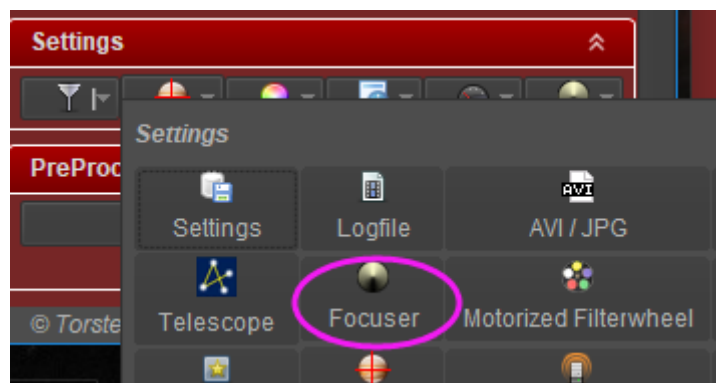

2. Check "Use ASCOM Focuser"

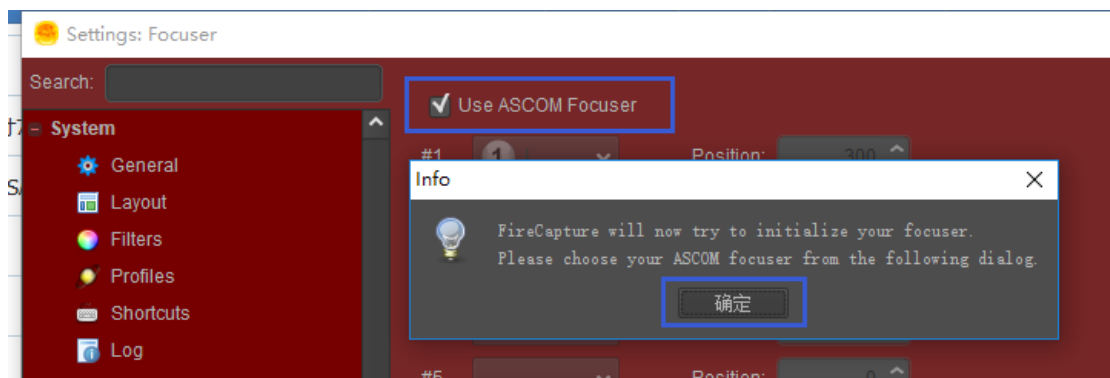

3. Choose ZWO Focuser in ASCOM panel.

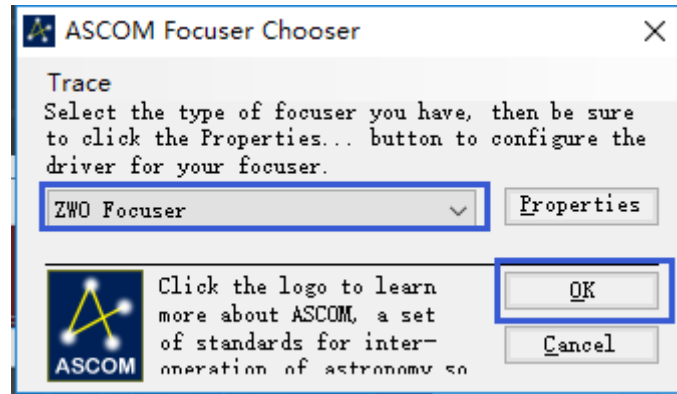

## Sequence Generator Pro

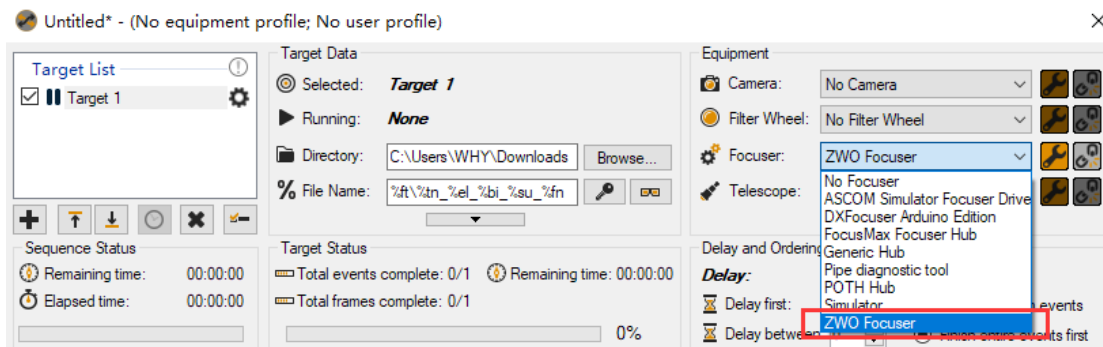

## Maxim DL Pro

1. Open “Observatory panel”, in “Focuser 1” option, click “Choose...”.

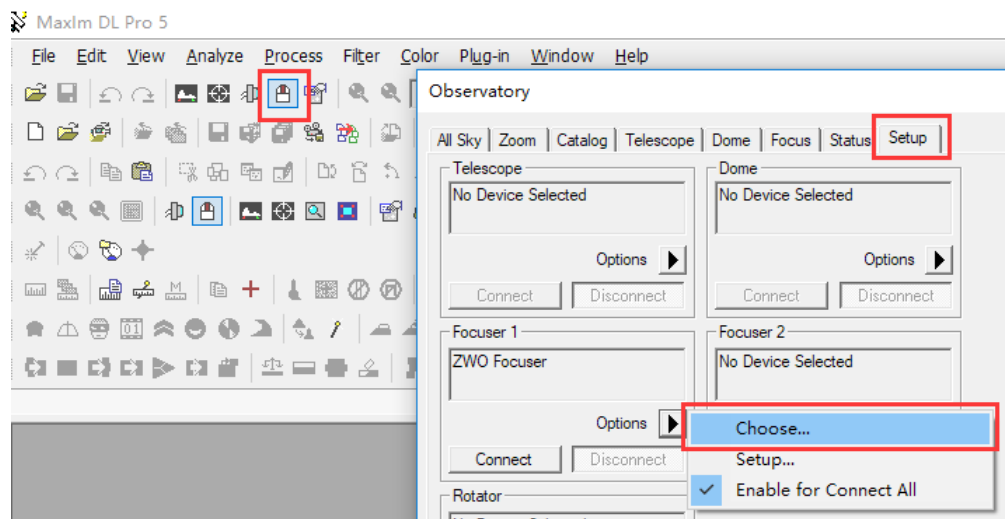

2. Choose ZWO Focuser in ASCOM panel.

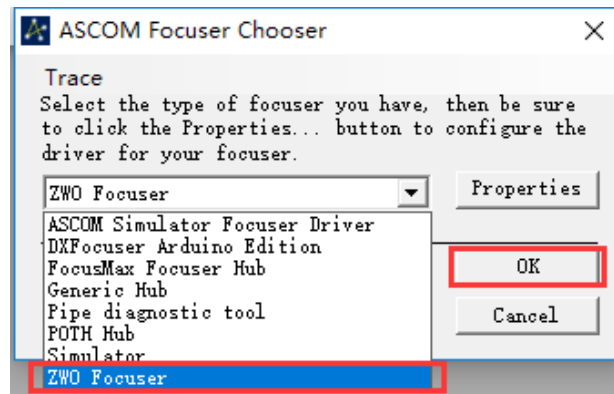

## Nebulosity

To be added

## The SkyX

1. Open “Telescope” menu, and select “Telescope Setup”

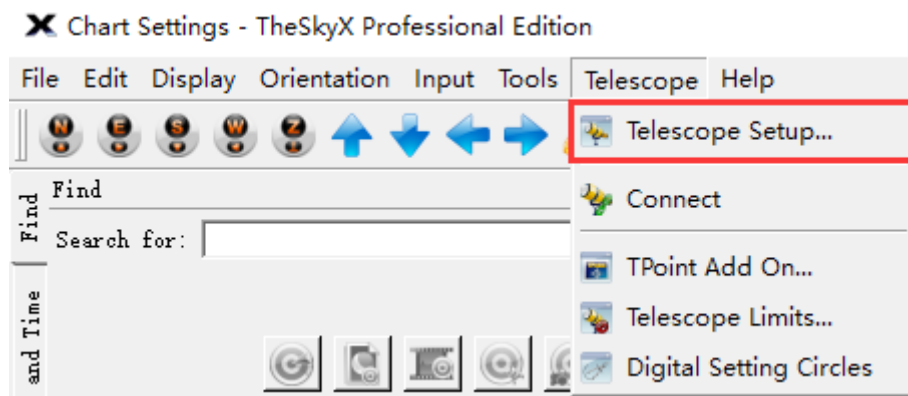

2. Select “Focuser Setup”

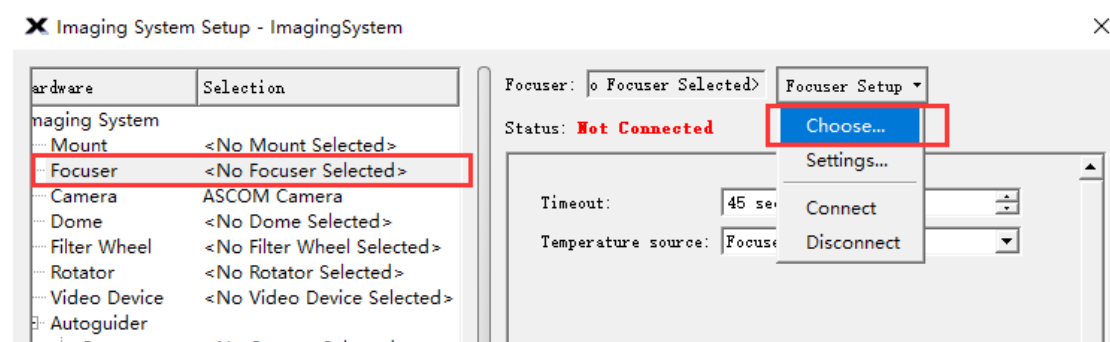

### 3. select ASCOM Focuser

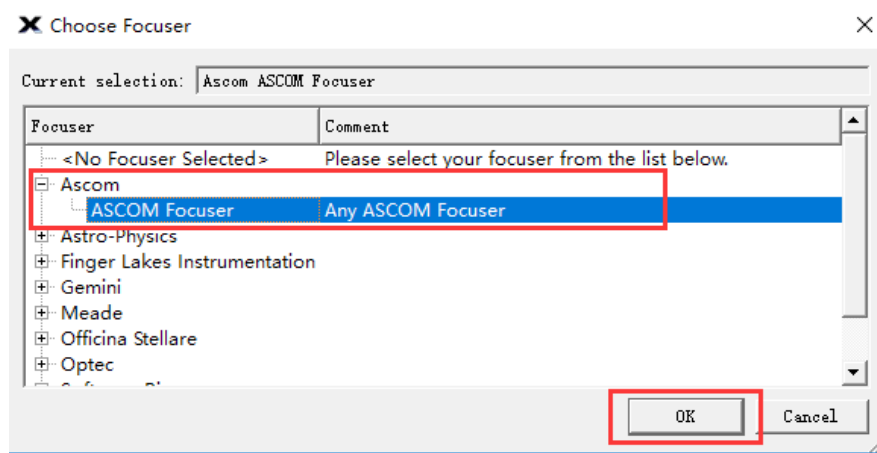

### 4. Setup the settings of ASCOM focuser.

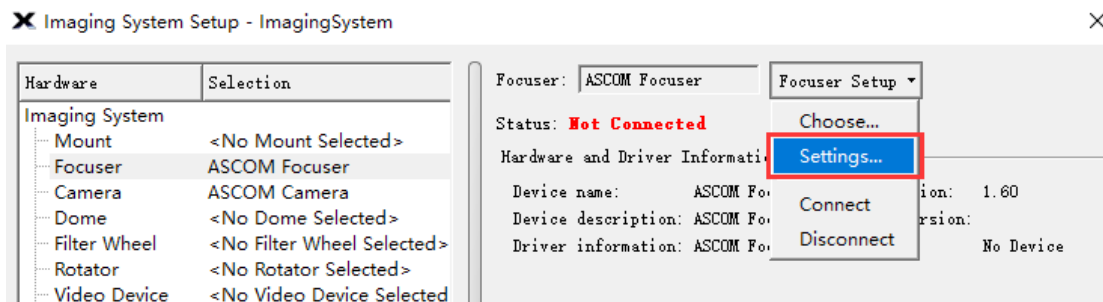

### 5. Choose ZWO Focuser

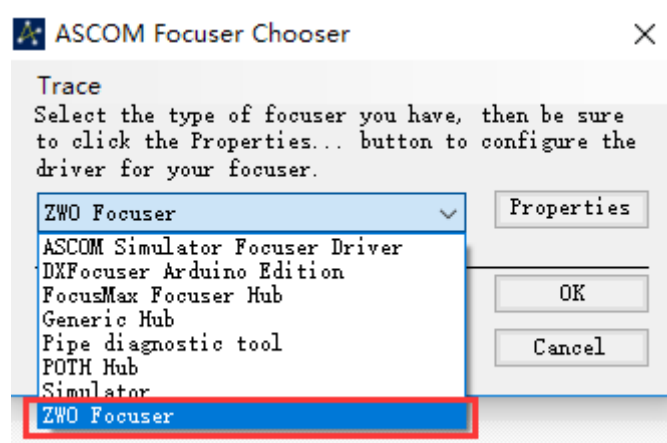

## Additional Installation Information

There is significant torque from the EAF stepper motor. We recommend setting the 0 position and the maximum number of steps as a first step to prevent possible damage to the focuser.

**For the standard bracket installation:**

The 0 position is recommended to be set to the position when the focuser is fully retracted.

The maximum number of steps is recommended to be set to a limit position less than or equal to the full focuser stroke.

**For the curved saddle installation:**

The 0 position is recommended to be set near the focused position.

The maximum number of steps is recommended to be set to a limit position less than or equal to the focus seat stroke.

## 9. Manual/Automatical Focus Control

Your EAF is able to be manually controlled and there are two ways to achieve this. One is via the optional hand controller and secondly via the astronomy software package in use.

We recommend you align your EAF in the daytime and use a distant target such as a building to focus on when setting up the focuser for the first time. This will help you in finding the correct focus position with plenty of light to illuminate the chosen object.

When you have found the correct focus position during the daytime, make a note of the step count number. When observing in the dark later, this will make finding the focus position easier and trouble free.

## ASISudio

ASISudio supports both manual and auto focus. Take ASICap for an example of how to manually do focusing.

1. When the image looks very fuzzy, use “coarse” button.

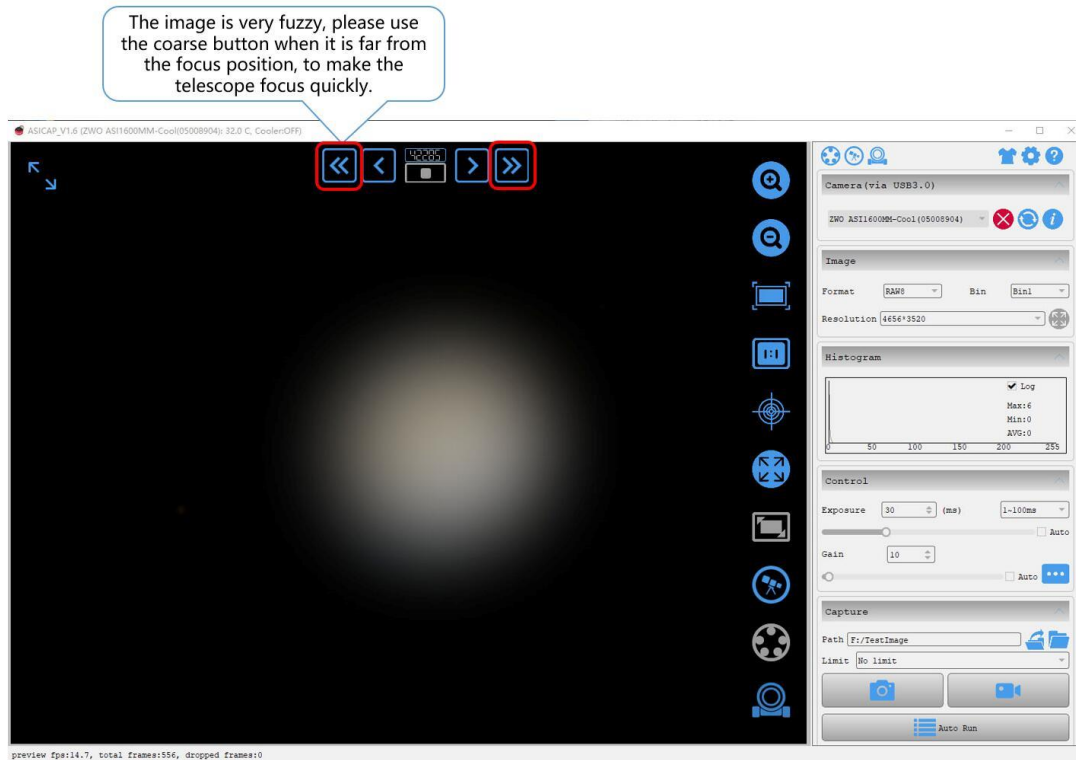

2. When the image looks slightly blurred, use “fine” button.



If the image is slightly blurred and very close to the focus, use the fine button to make the telescope focus precisely.

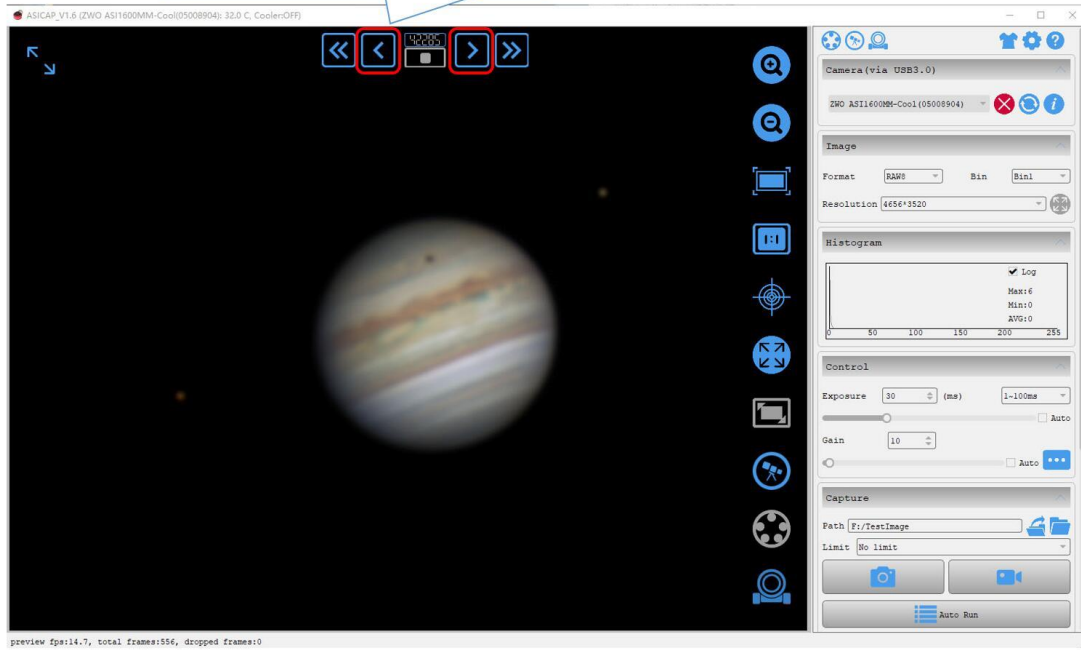

### 3.Done

Done!

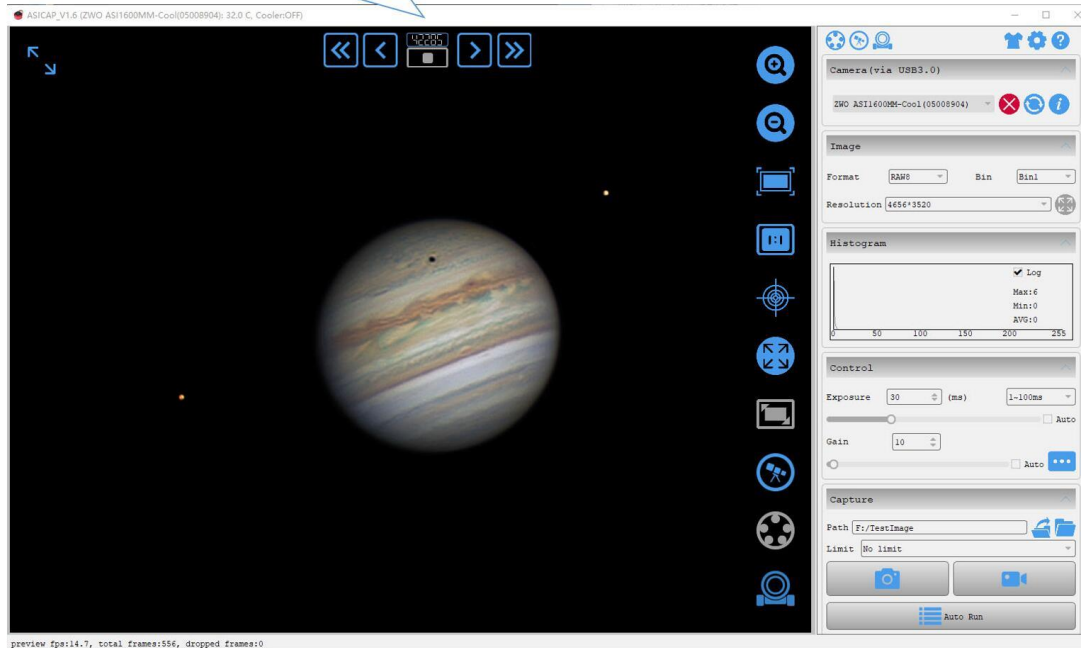

### 4. Goto ZERO position.

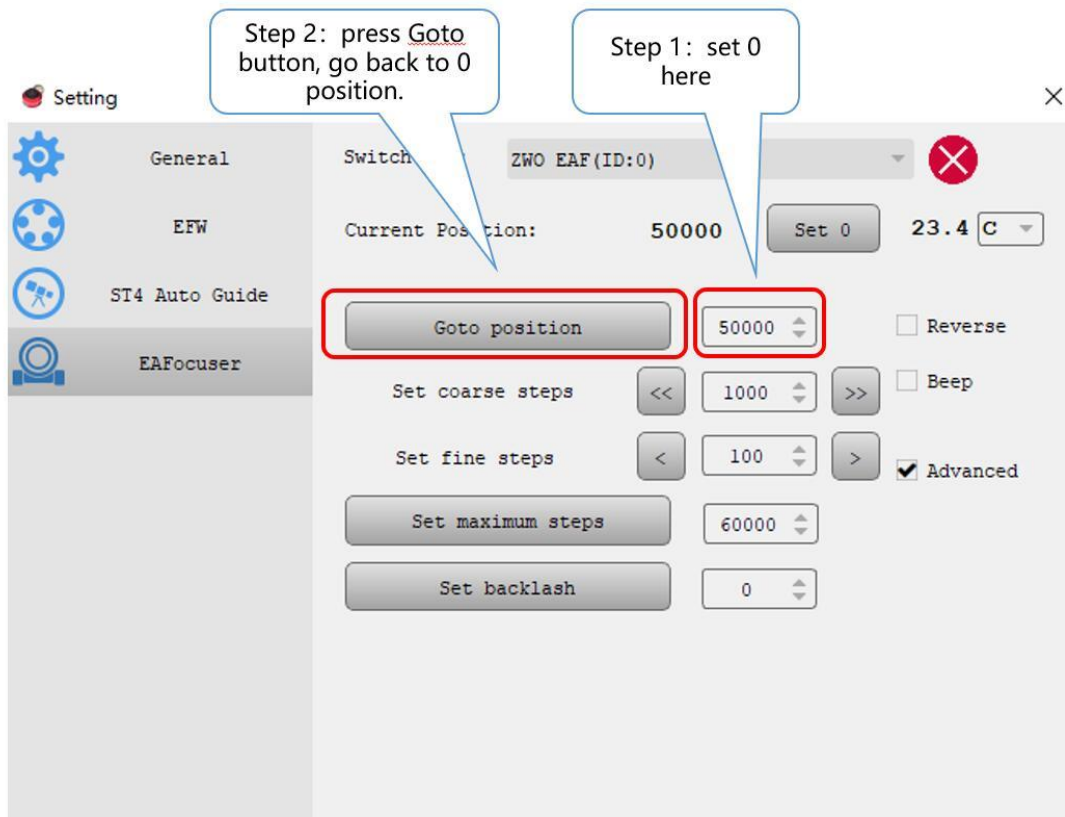

And then take ASIIImg for an example of autofocus.

1. Turn on the camera.

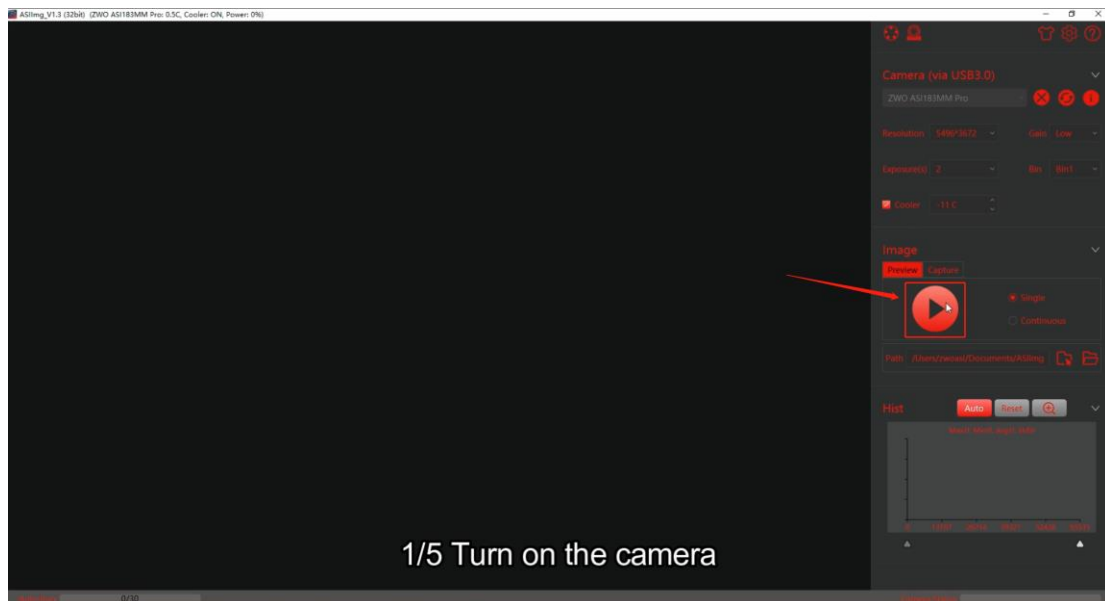

2. Click the EAF icon in the Vertical Tool Bar.

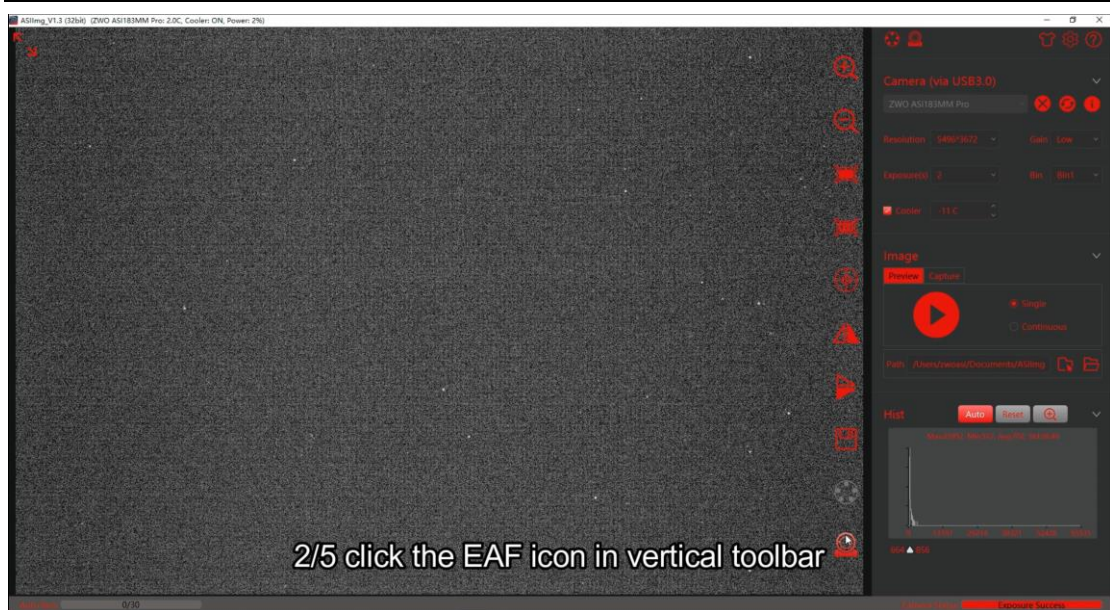

3. Click the AF icon in the Horizontal Tool Bar.

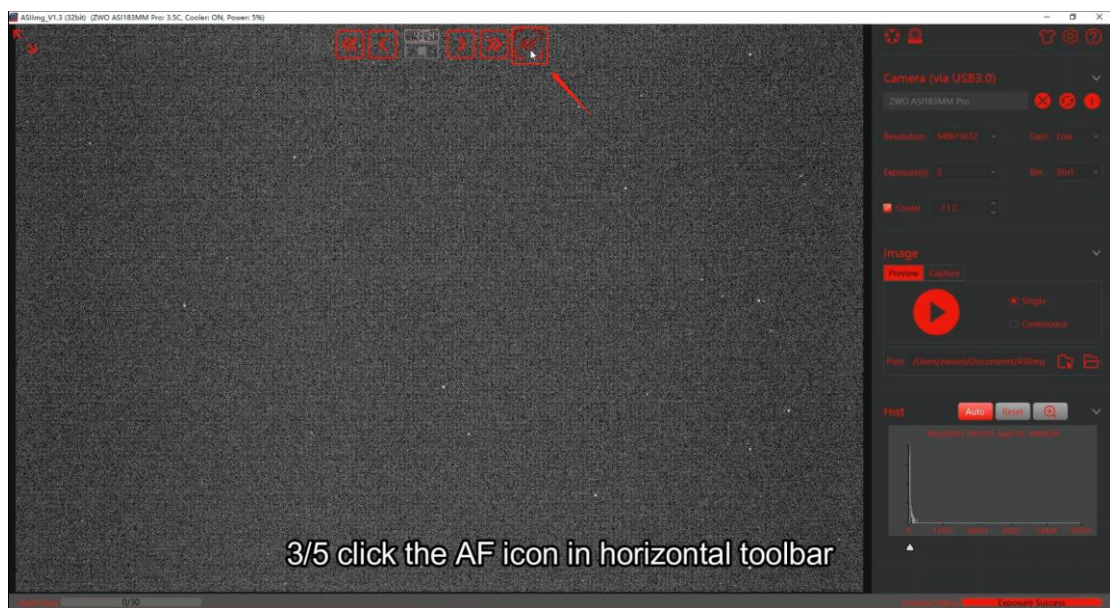

4. Set EXP value and choose the bin mode.



4/5 Set appropriate EXP and Bin

5. Click the Run button and wait a moment.

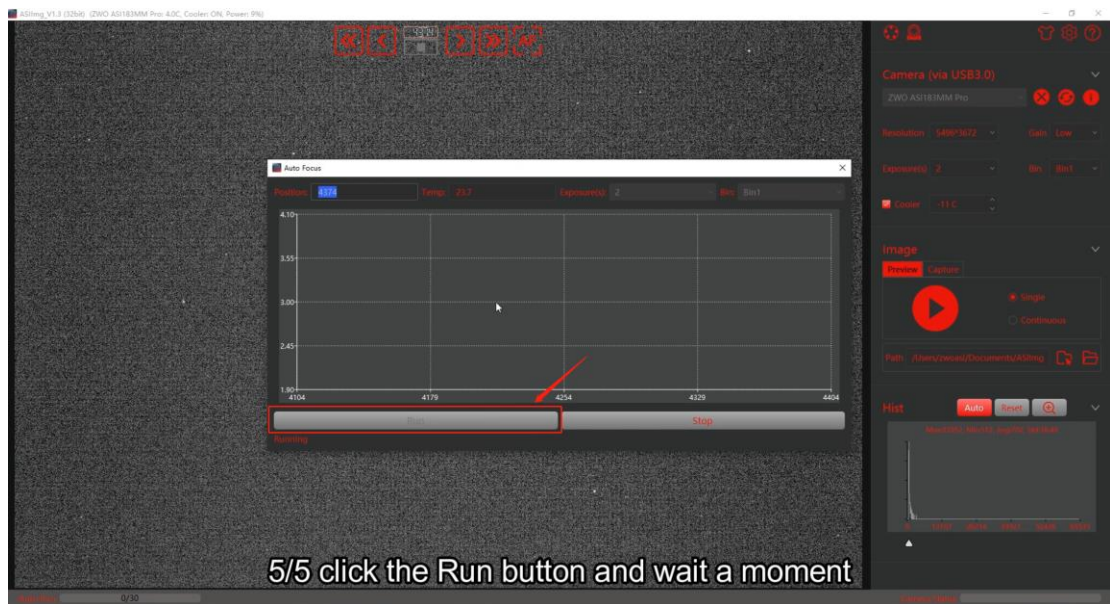

5/5 click the Run button and wait a moment

6. Done!

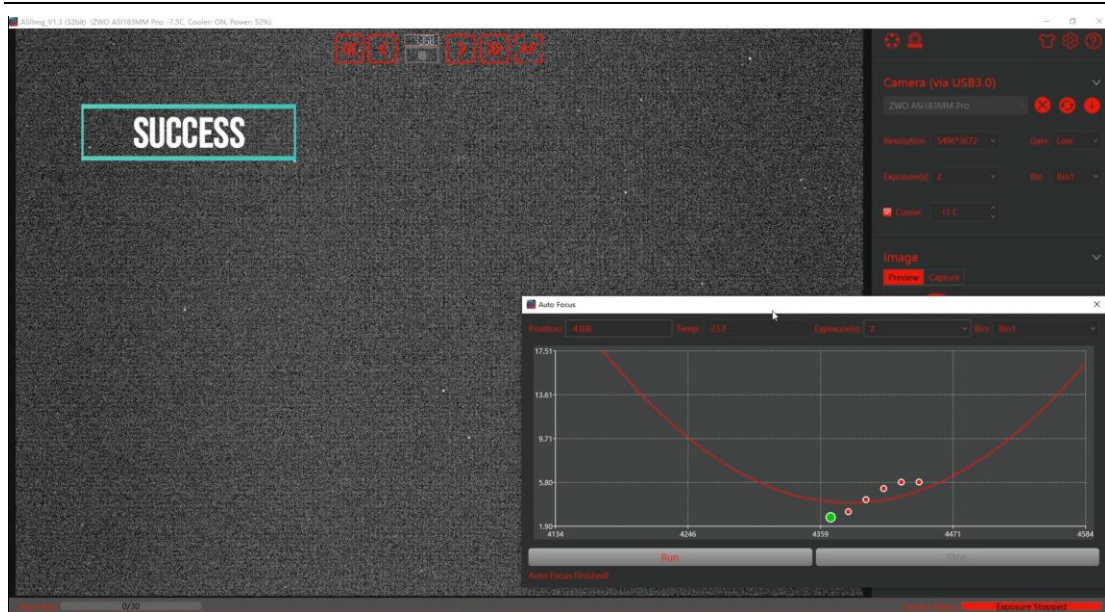

## ASIAIR

ASIAIR also supports both manual and auto focus. For the detailed instruction, we recommend you head over here:

<https://www.yuque.com/zwopkb/asiair/focus>

## Sequence Generator Pro

SGP's autofocus is very easy to use. When using SGP please set the freewheel setting in the ASCOM driver to 0 to avoid affecting the focusing speed.

1. Open the focus control dialog box

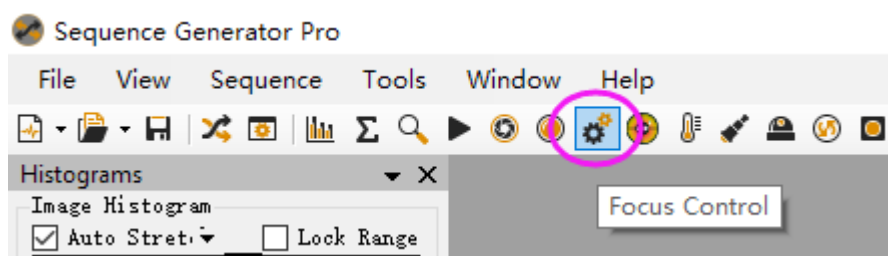

2. Enter the settings menu by clicking the setting icon

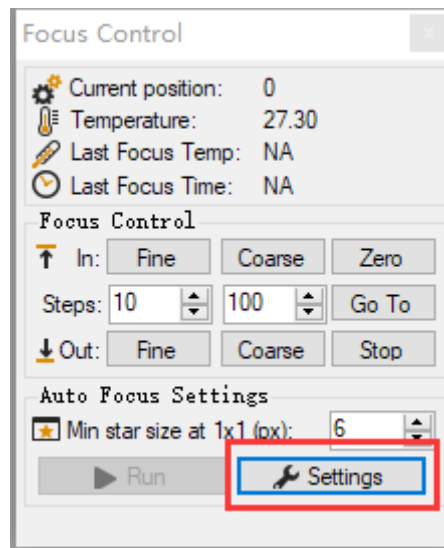

### 3. Set the Auto Focus parameters as below

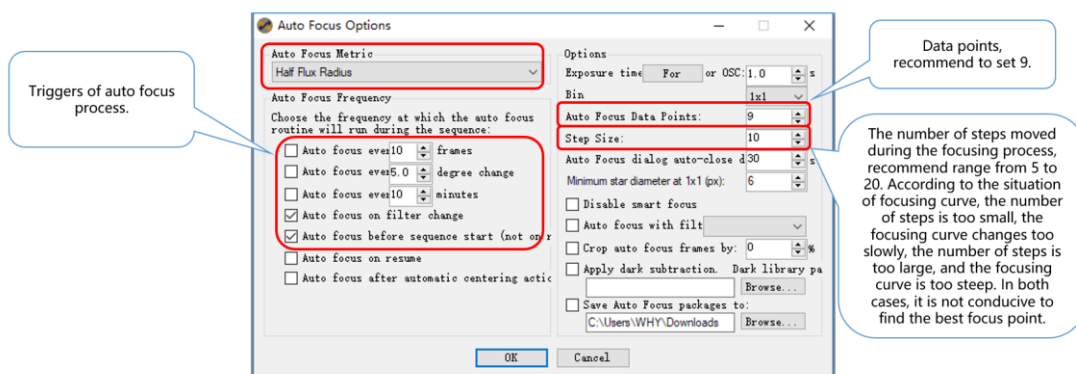

### 4. Set the focuser backlash settings

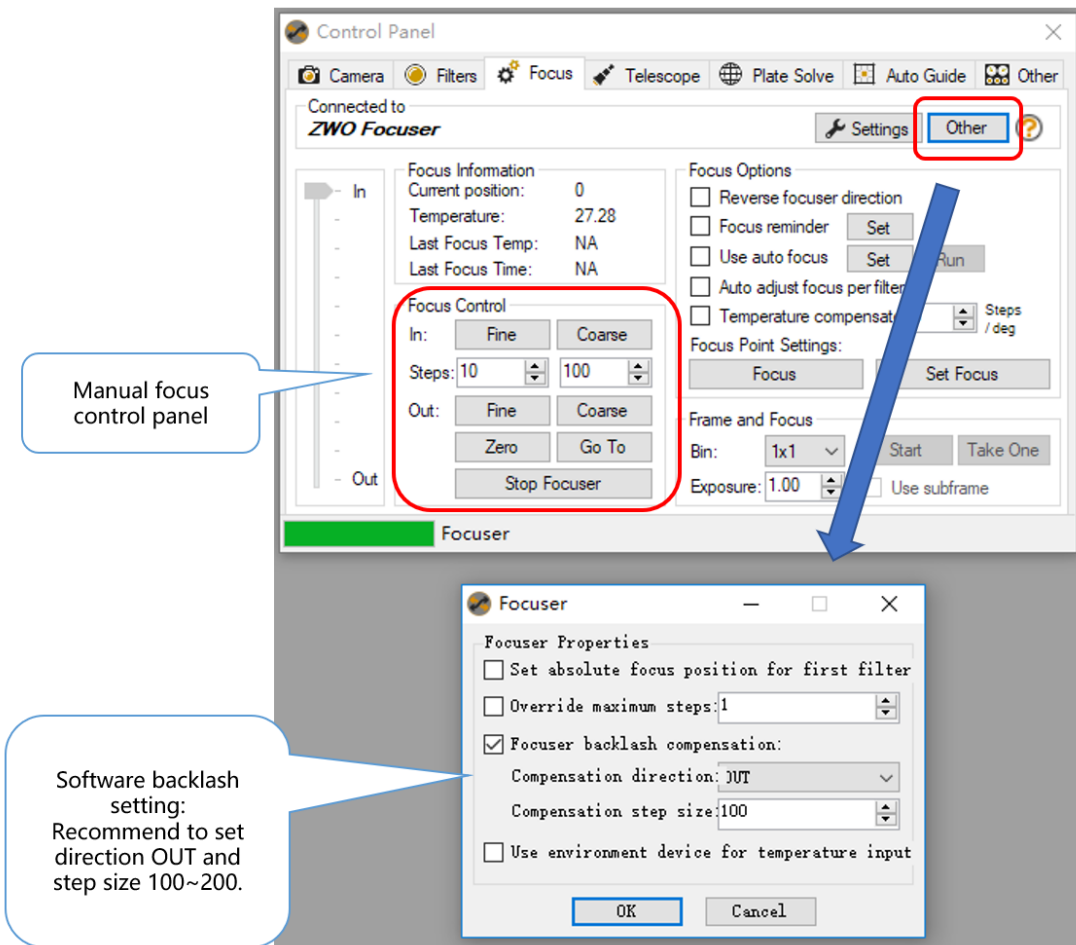

5. With the telescope roughly in focus before you start, click the run button to start the autofocus procedure.

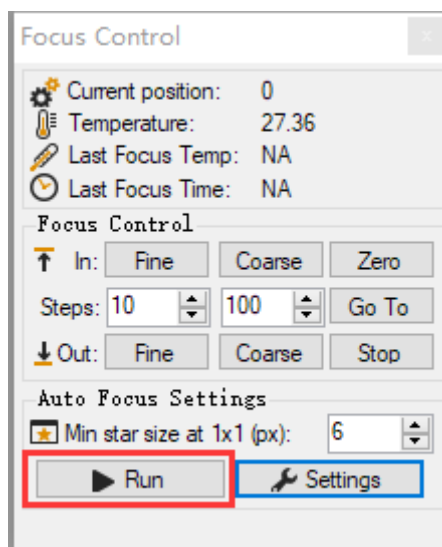

SGP will automatically take exposures and move the focuser steps drawing a V curve tracking the stars HFR value. Once the curve is complete SGP will drive the focuser to the best measured value.

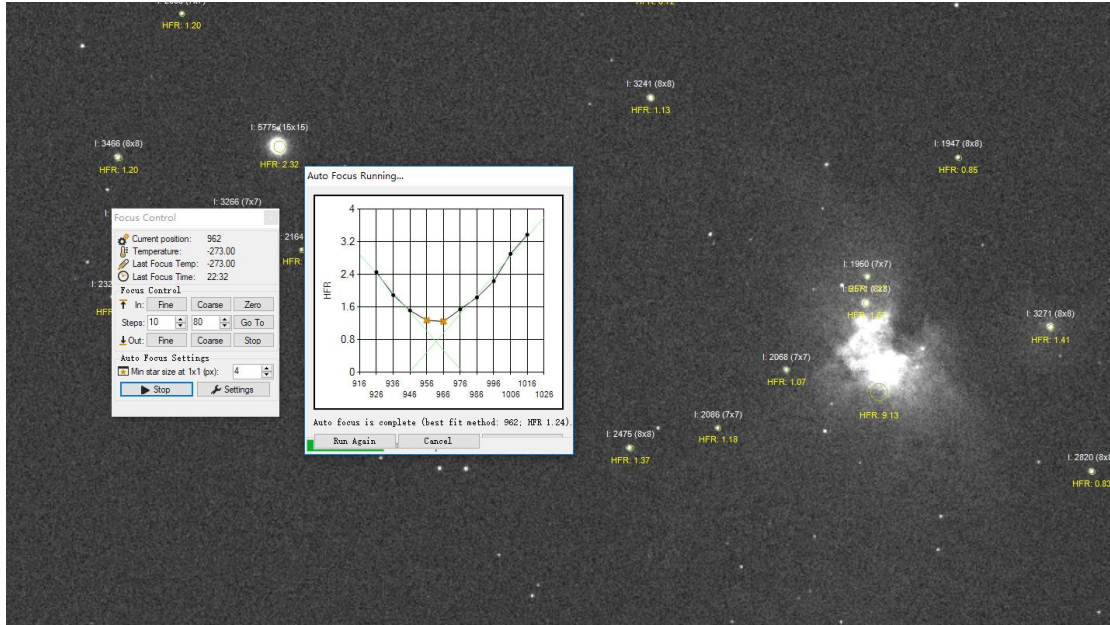

## FocusMax

Step 1: Set up the camera. Open the software, click System to enter the settings interface. Click the button 2 as shown below, click Choose to enter the EAF settings menu.



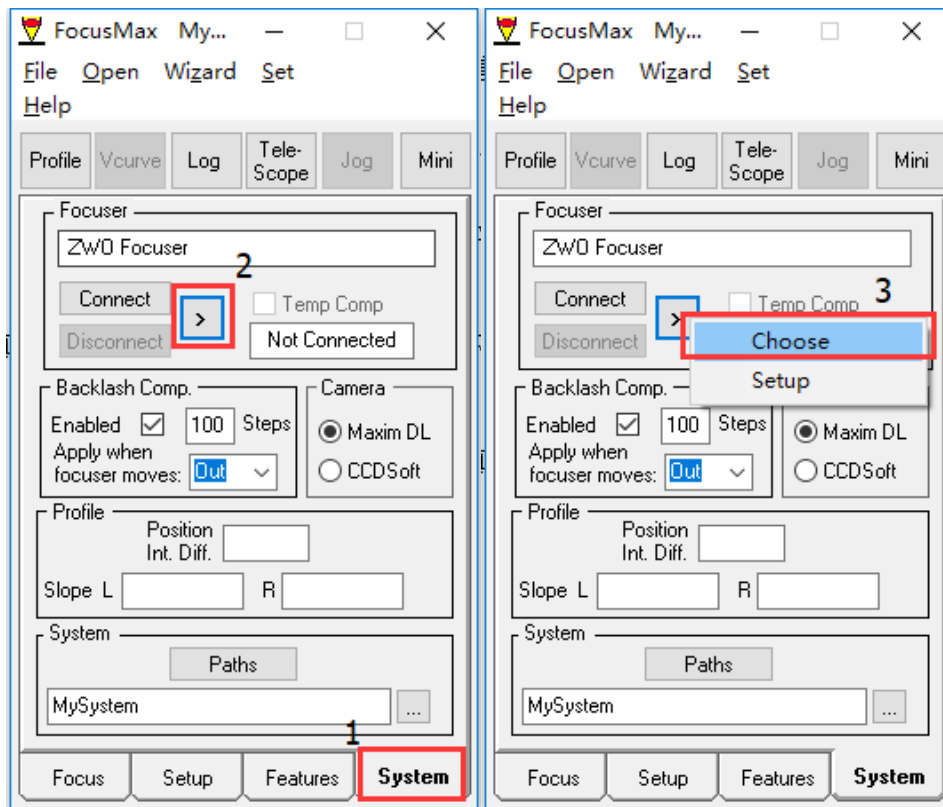

Step 2: Select the ZWO Focuser in the dialog and click OK.

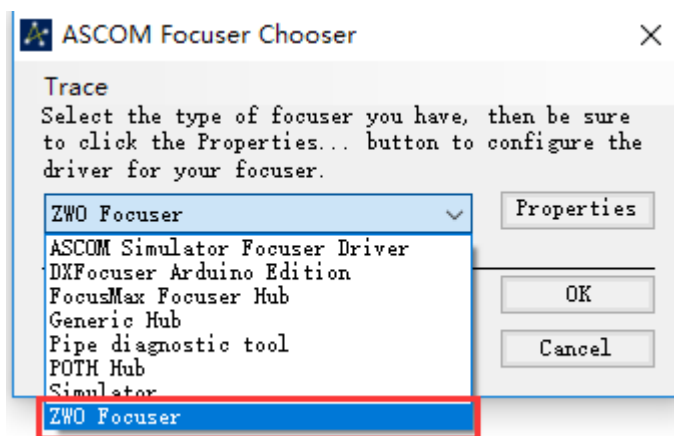

Step 3: Next, connect the EAF. Click the Connect button and wait for the connection to be made

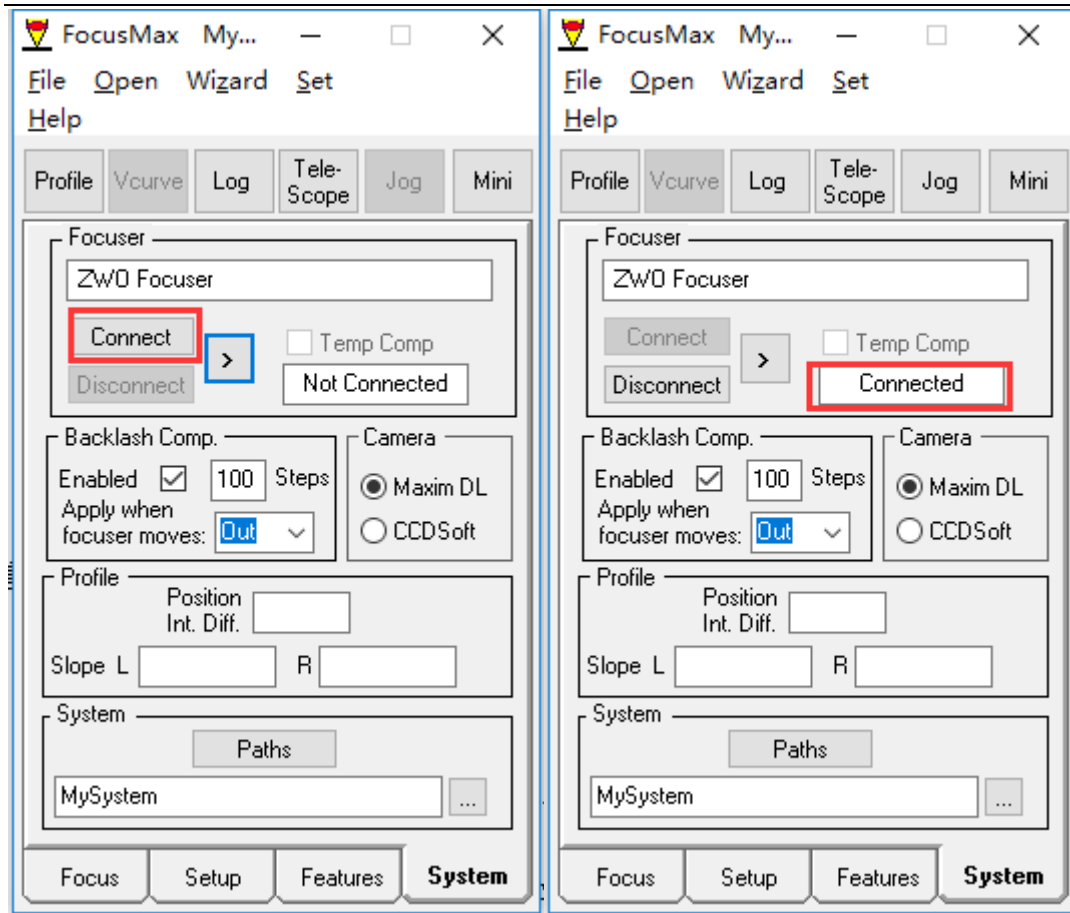

Step 4: Next set the Backlash Compensation and Camera Control

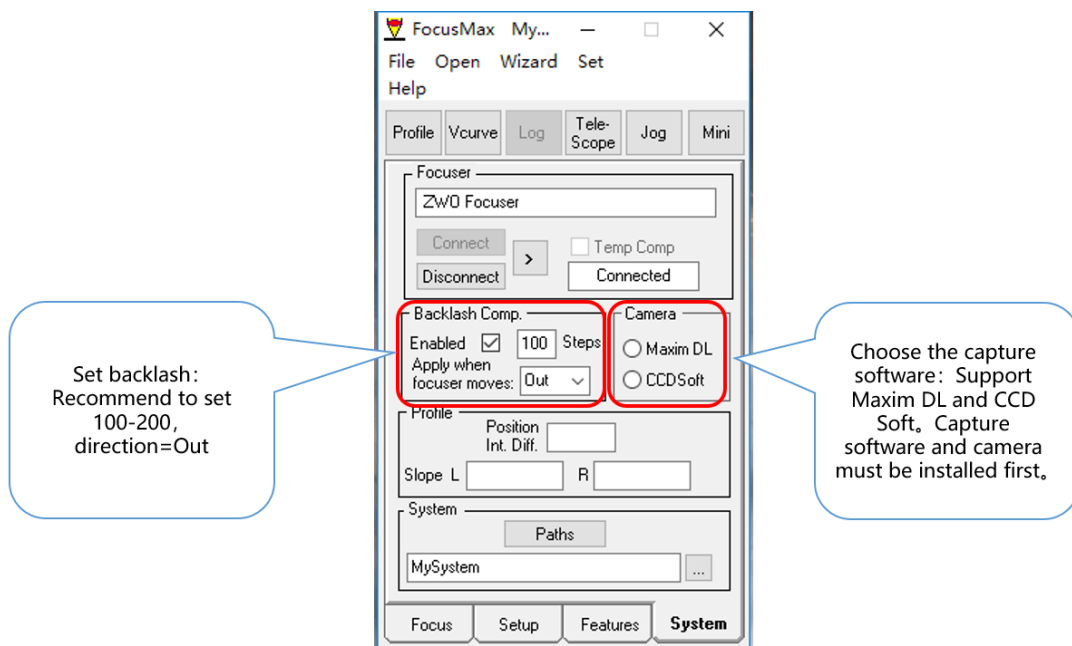

Step 5: Set the Exposure and Focus Mode

The screenshot shows the FocusMax software interface with several settings highlighted by red boxes and callouts:

- Move:** The **In** radio button is selected. Callout: "Direction in focusing: Recommend to set IN."
- Autofocus:** The exposure settings are Min: 1.00, Max: 10.00, and Base Exp: 1.00. Callout: "Exposure in focusing: Recommend to set Min=1, Max=10, Base Exp=1."
- Focus Start:** The **HFD** radio button is selected. Callout: "Focusing method: Recommend to set HFD"

Step 6: Open the Vcurve dialog box and set the number of steps per move (generally set to -10). Run the autofocus routine:

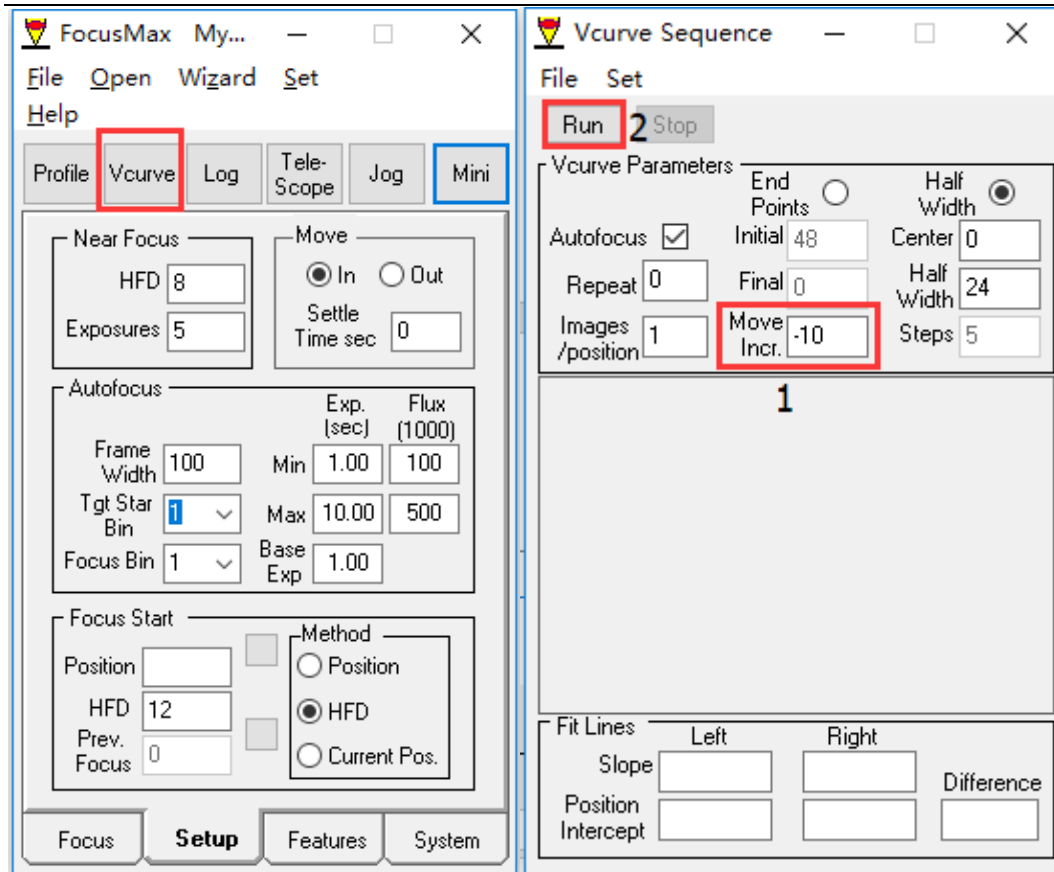

After the V curve is drawn the focuser will be driven to the optimal focus position.

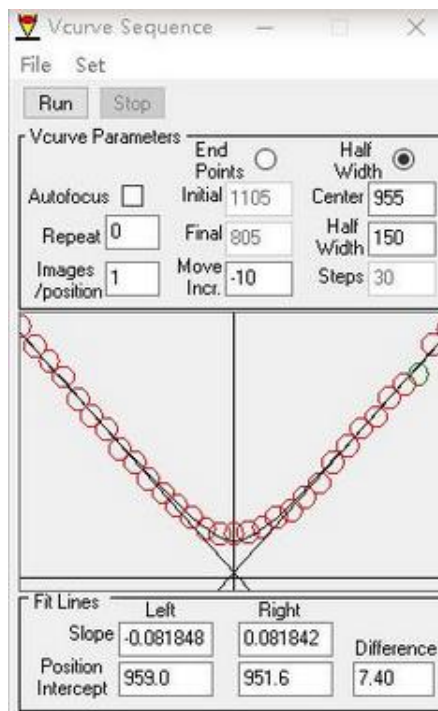

## Measuring the Focuser Backlash

It is relatively easy to measure the focuser backlash. The following example uses ASICAP as the software application driving the EAF:

Set the coarse step size to 1000 and the fine step size to 10.

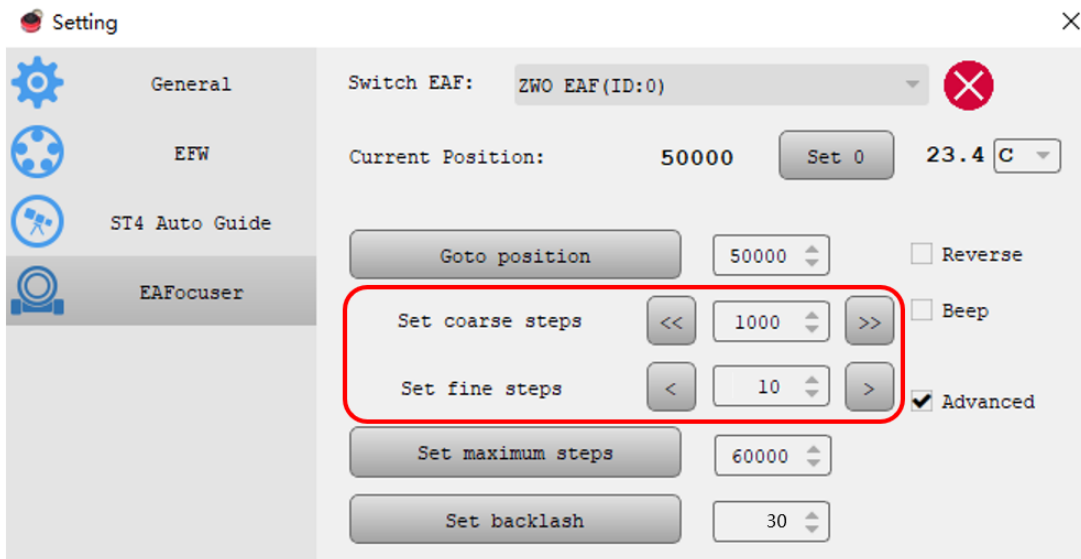

Click the Coarse Button and move the focuser out by 1000 steps.



Next set the fine tuning steps to 10 and move the focuser in and observe that the focus knob on the side of the focus rotates.



Click the fine adjustment button that moves the focuser inwards and click once. Observing the focuser knob on the opposite side to the EAF note how many steps the EAF moved before the knob moves. The number of times you click x 10 is the number of steps measured as backlash.

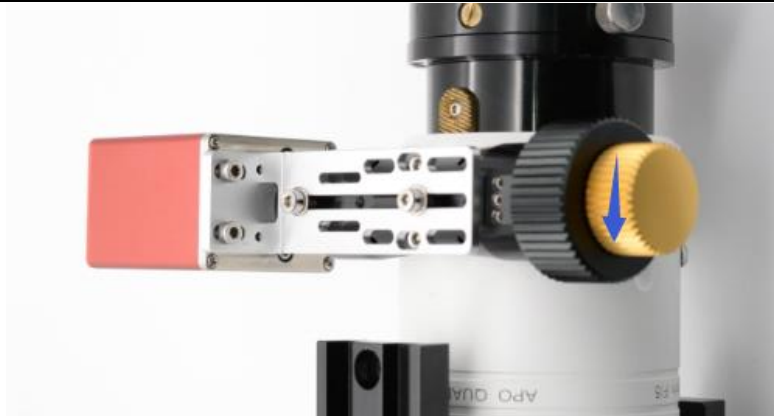

Set the number of steps in the Set Backlash settings box

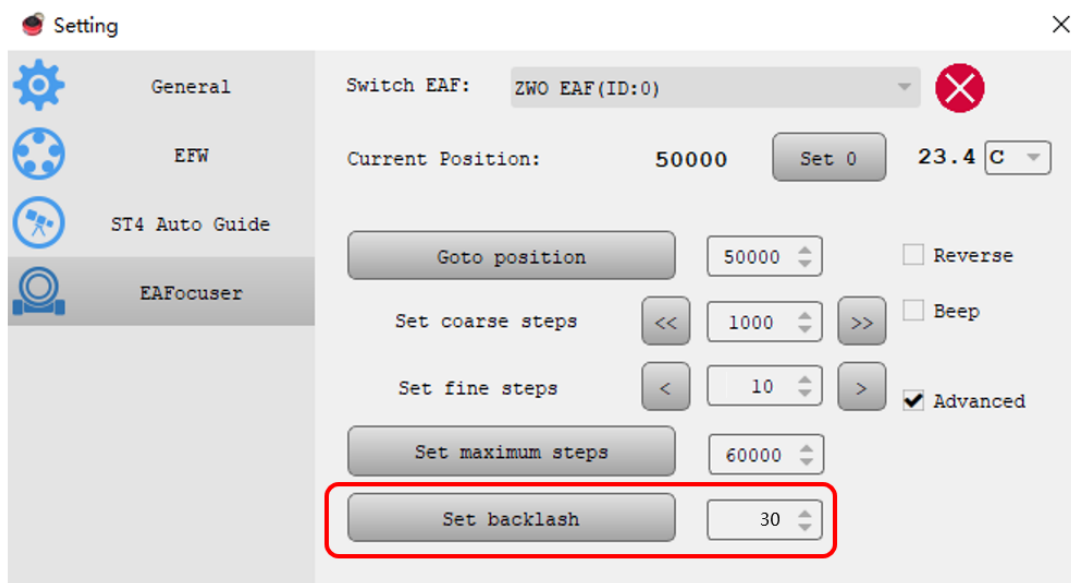

If you want to measure the backlash setting more accurately then chose Step Size 5 in the fine step setting and repeat the above steps.

## 10. Warranty and Return Policy

We provide 2-year warranty for our products.

We will offer the repair service for free or replace the item for free if the EAF does not work properly within the warranty period. After the warranty period, we will continue to provide repair support and service on a charged basis.

This warranty does not apply to damage that occurred because of abuse or misuse, or damage caused by a fall, or any other accidental failures after purchase.

The customer must pay for shipping when shipping the EAF back for repair or replacement.

If you get a faulty EAF, please contact us as soon as possible via the ZWO support page:

<https://support.astronomy-imaging-camera.com/>

Please describe the problem in detail, and we will do our best to solve the problem. Most instances are perceived problems which are caused by a bad driver install or software configuration.

For customers who bought the camera from our dealer, the dealer is responsible for the customer service.