



MV



VEM SOLUTIONS

MOTOR - GENERATOR - VFD - IOT



HIGH PERFORMANCE VECTOR CONTROL
MEDIUM VOLTAGE DRIVE

GD5000 SERIES





TABLE OF CONTENTS

About VEM.....	1
Product introduction.....	2
Production family tree	2
Application fields.....	3
Product structure.....	4
System bypass solution.....	4
Product features.....	5
Technical parameters.....	8
Standard terminals.....	9
Product model instruction.....	9
Two-quadrant topology.....	9
Two-quadrant selection table.....	10
Four-quadrant topology.....	18
Four-quadrant selection table.....	19
Outline drawing.....	21
List of options and parts.....	22

ABOUT VEM



VEM in Asia has been established in 2003 incorporated in Singapore. A small and smart Team leading new sales and after sales services for whole APEC and Oceania areas. A stock in Singapore ensure availability for Marine and flameproof motor within a few minutes.

VEM is an innovative, internationally-active and reliable manufacturer of technically sophisticated system and drive solutions, custom drives and single components. The output capacity ranges from 0.06 kilowatts to 60 megawatts / 90 megavolt ampere. Continuity and reliability, including in the future, this is what the production and service at VEM stands for. The engineering and quality of the products with the VEM logo are trendsetters within the market.

Product introduction

UGD5000 series medium-voltage VFDs are the medium-voltage variable frequency drive independently developed. By adopting the most popular serial technology of power units, taking DSP+ARM+FPGA three-core processor as the control core, and integrating the most advanced motor vector control algorithm, the system owns the characteristics of high control precision, fast response speed, and low frequency and large torque, which are quite suitable for medium-voltage asynchronous motor and synchronous motor energy saving speed regulation and process improvement. GD5000 series medium-voltage VFDs have been widely used in fans, pumps, compressors, belt conveyors, hoists, and other loads.



Product family tree

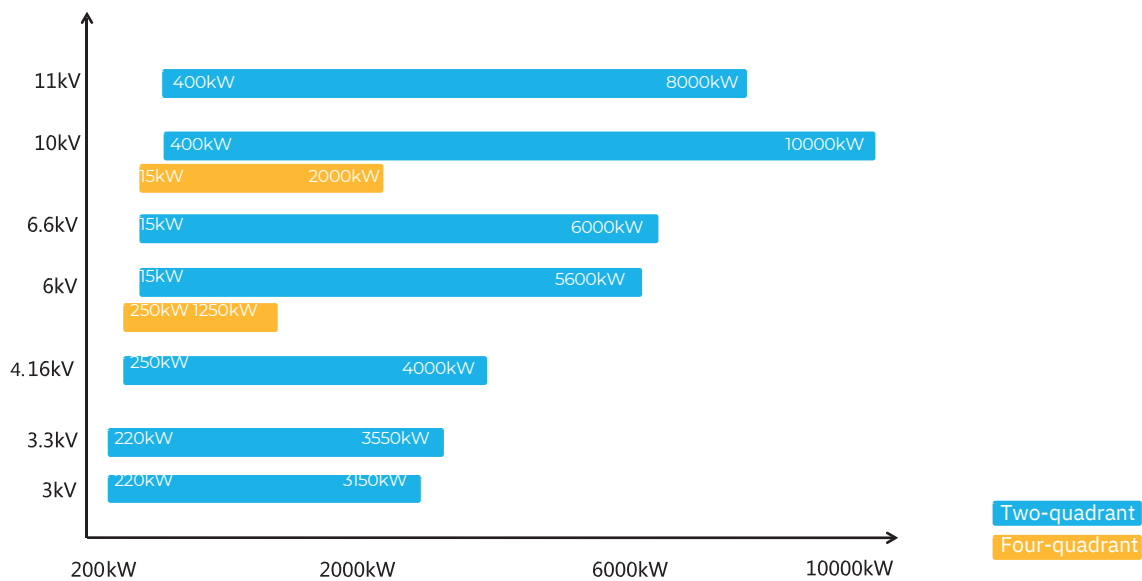

Application fields

Power

- ID (induced draft) fan
- FD (forced draught) fan
- Primary fan
- Secondary fan
- Feed water pump
- Circulating pump
- Condensate pump
- Mortar pump, etc.



Mining

- Main ventilator
- Forcing fan
- Exhaust fan
- Air compressor
- Gas drainage pump
- Medium pump
- Draining pump
- Belt conveyer
- Roller press
- Primary and secondary mine hoist, etc.



Metallurgy

- Sintering main drawing fan
- Blast furnace blower
- Dusting blower Sulfur dioxide blower
- Ring cooling fan
- Combustion fan
- Circulating pump
- Slag washing pump
- Dephosphorization pump
- Chemical liquid pump
- Slurry pump
- Rolling mill, etc.



Oil and gas

- Fuel supply pump
- Water injection pump
- Electric submersible pump
- LNG pressure pump, etc.



Cement

- High temperature fan
- Exhaust fan at furnace head
- Exhaust fan at furnace end
- Coal mill circulating fan
- Raw mill circulating fan
- Cement mill circulating fan
- Ball mill fan, etc.



Municipal engineering

- Clean water pump
- Sewage pump
- Purifying pump
- Mixed-flow pump
- Oxygen blower, etc.



Chemical

- Dusting blower
- Gas blower
- Roots blower
- Sweetening fan
- Gas compressor (nitrogen, CO₂, and ammonia)
- Circulating pump, etc.



Others

- Pharmacy and paper making: fan and water pump
- Sugar industry: feeder and presser
- Rubber and plastic industry: internal mixer



Product structure

Cooling fan

- Well-known brand, high reliability, large air flow, and small noise

Power unit cabinet

- Power units in series connection. Each power unit is equivalent to one AC-DC-AC voltage-type single-phase low-voltage VFD;
- Modular design. All power units can be interchanged.



Touch screen

- TFT LCD, lifelike display;
- User-friendly interface, easy to operate.



Transformer cabinet

- Adopting phase-shifting transformer for multi-pulse rectification greatly improves current waveforms at the grid side and effectively reduces harmonic pollution to the grid;
- Equipped with temperature controller to monitor the real-time states of the transformer and ensure the safe operation.



Control cabinet

- DSP+FPGA+ARM 3-core control technology, high system control precision and rapid response speed;
- Adopt optical fiber communication with strong anti-interference performance between main control board and units

System bypass solution

- Manual bypass system need extra GD5000-MS manual bypass cabinet
- Automatic bypass system need extra GD5000-AS automatic bypass cabinet
- Support 1 drive more solution base on client requirements

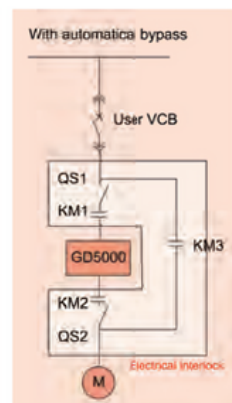
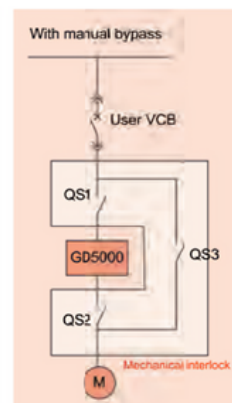
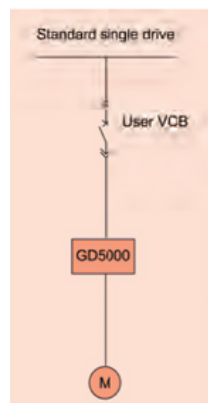

Product features

1 Three kinds of motor control technologies

High-performance V/F

High precision control mode, and there is no need to install the speed sensor.

Open-loop vector

Motor common control mode, supports various control curves and V/F separation function.

Closed-loop vector

Ultra-high precision control mode, supports incremental encoders.

2 Drive two kinds of motors

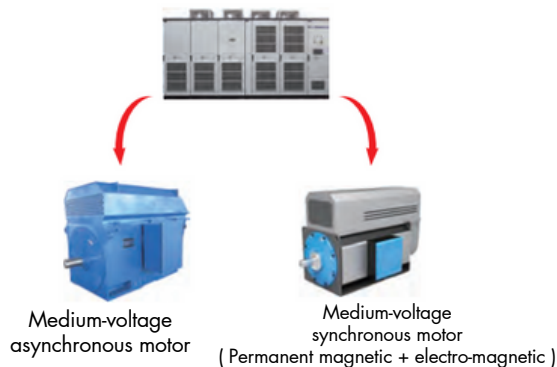

3 Four-quadrant driving technology (Four-quadrant VFDs)

- The power units use IGBT for rectification, achieving dual energy flow, energy saving and environmental protection.
- With 100% full power energy feedback capability.

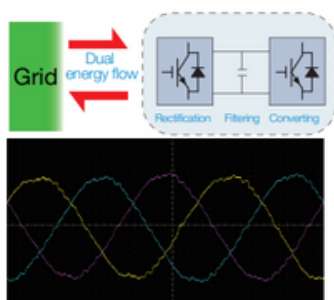

4 LVRT low-voltage ride through technology

- Wide-range voltage anti-interference capability. The system has AVR (automatic voltage regulation) function for meeting the harsh grid environment.
85%-110% Full-load output
65%-85% Derating output
110%-120% Derating output
- No stop upon instantaneous power-off. During running, the system will not stop after the user medium-voltage bus powers off in the allowed time (0-5s). The former set value can be reached again if the voltage is restored within 0.1-1s after power-off.



5 Full-band rotating speed tracking

- When the VFD is started under the condition that the running state of the motor is unknown, the system can accurately track the current rotating speed and direction of the motor, and control matching output voltage, so as to realize the flying start and reduce the impact on the power grid.

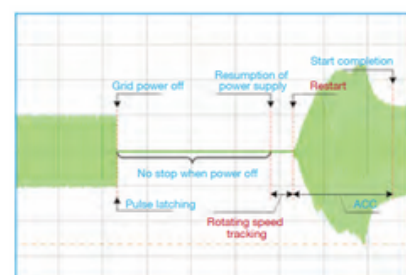

6 Unit bypass technology

- The same-level bypass. When one unit is failed, the system can automatically bypasses the corresponding unit of each phase, which is suitable for occasions where derating to run can be conducted.

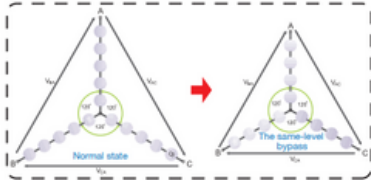

- The same-level bypass. When one unit is failed, the system can automatically bypasses the corresponding unit of each phase, which is suitable for occasions where derating to run can be conducted.

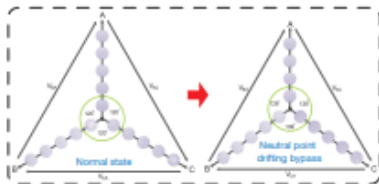

7 Excellent low frequency control

- With advanced dead zone compensation technology, good low-frequency waveforms, and optimized algorithm of low frequency oscillation suppression, no motor resonance will occur.

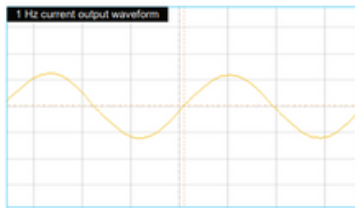

8 Dual-frequency braking technology

- By superimposing the reverse high-frequency component on the output voltage, a strong braking torque is generated, which can greatly reduce the motor deceleration time and apply to the occasions with high requirements on load braking.

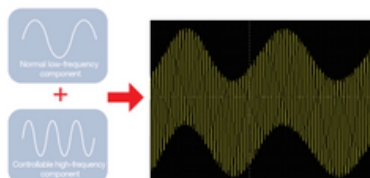

9 Master-slave control technology

- With the multi-motor drive system solution, it can realize multi-motor coordination control and obtain power balance.

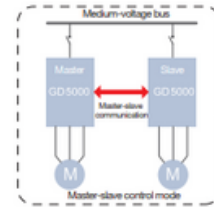

- The load can be connected rigidly or flexibly;

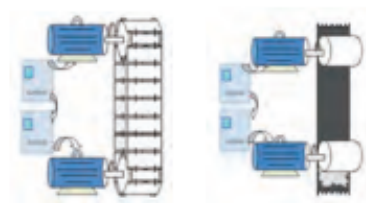

- Optical loop connection. Support a maximum of 16 motors for master-slave control, and the master can be set flexibly according to on-site conditions.

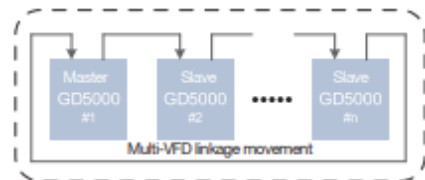

10 Synchronous bumpless switching

- With advanced "frequency-phase locking" control technology and high frequency-phase synchronization precision, smooth switching without impact between variable frequency and power frequency can be realized.
- Apply to the occasions of one-drive-more and soft start of the motor with large capacity.

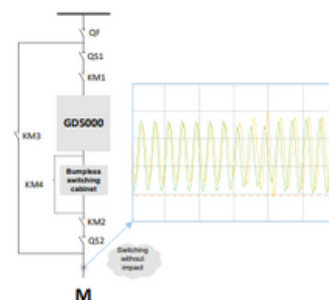

11 Optional thin-film capacitor with long service life

- Medium voltage endurance capability and very high insulation resistance;
- Low ESR (equivalent series resistance) and strong resistance to ripple current;
- Good anti-pulse capability and high reliability;
- Very low loss, less heat, and long service life.

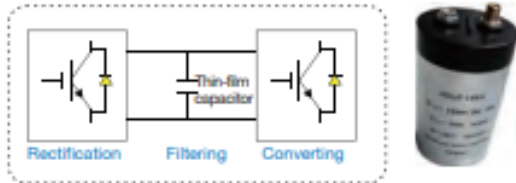

12 Rich bus interfaces

- Support various communication protocols including Modbus-RTU, Profibus-DP, Profinet, and UDP/IP, facilitating the connection with user DCS system and realization of device centralized management.



13 IoT monitoring program

- Remote monitoring: Conduct real-time monitoring on device status and operation data through computer, mobile phone or tablet PC.
- Device management: Establish data files and reports for each device to so as to facilitate historical tracing.
- Active fault alarm: Push the fault information to the customer in real time by SMS and change the passive inspection to active alarm for improving the work efficiency.
- Remote fault diagnosis: The manufacturer assists in fault analysis positioning to shorten the maintenance time.

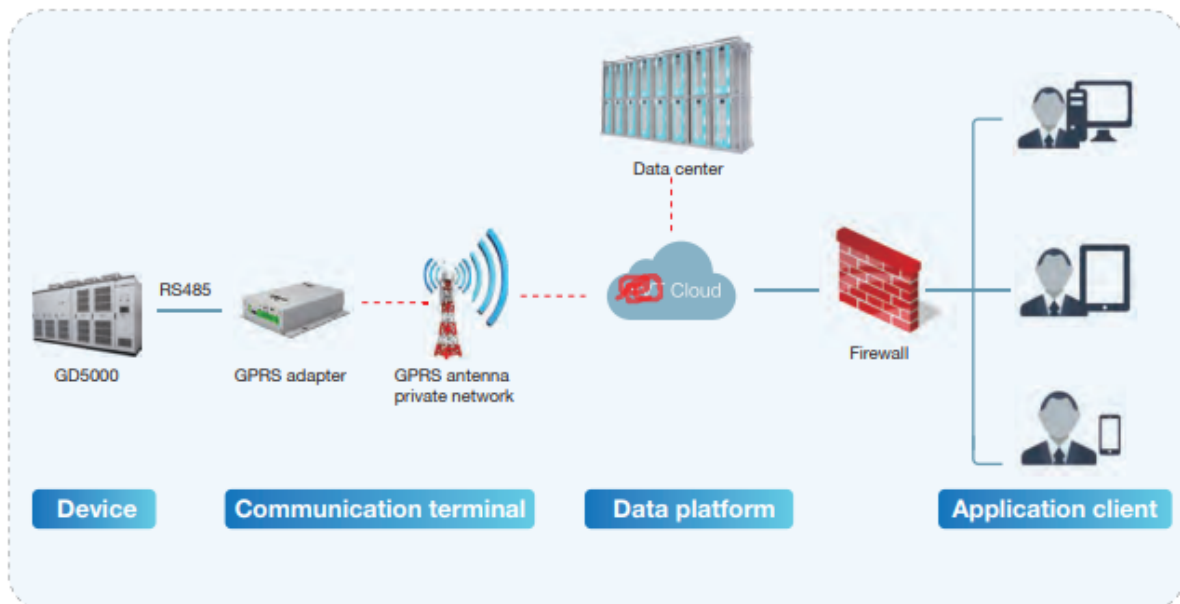

Technical parameters

Item		Two-quadrant parameters						Four-quadrant parameters		
Input	Voltage degree	AC 3PH						AC 3PH		
		3kV	3.3kV	4.16kV	6kV	6.6kV	10kV	11kV	6kV	10kV
	Pulse number	18	18	24	30	36	48	54	30	48
	Voltage fluctuation range	-15%~+10%(Max.support:-35%~+20%,deratingpoweroutput)								
	Voltage frequency	50/60Hz;±5%								
	Power factor	≥0.97(fullload)								
	System efficiency	Converter Efficiency ≥98%, system Efficiency ≥96%(full load)								
	Current harmonic	≤4%			≤2%			≤4%		
Output	Voltage range	0~rated input voltage								
	Frequency range	0~120Hz (customized)								
	Current harmonic	≤4%			≤2%			≤4%		
Control performance	Control mode	V/F; SVC; VC								
	Speed ratio	1:50 (VF); 1:100 (SVC); 1:200 (VC)								
	Speed control precision	±1% (VF); ±0.4% (SVC); ±0.2% (VC)								
	Torque response	<200ms (SVC); <100ms (VC)vv								
	Starting torque	0.5Hz 150% of the rated torque (SVC); 0Hz 180% of the rated torque (VC)								
	Overload capacity	120%: 120s; 150%: 5s; 200%: protect immediately								
	ACC/DEC time	0-3600s (customized)								
	Feedback control mode	None						Synchronous rectification control technology		
Feedback capacity	None						100%, that is, the maximum feedback power of the VFD is the same as the maximum output power			
User terminals	Digital input	8 channels digital input (extensible and programmable)								
	Digital output	8 channels relay output (extensible and programmable)								
	Analog input	3 channels: AI1, AI2: 0-10V/0-20mA; AI3: -10V-10V								
	Analog output	4 channels: AO1, AO2, AO3, AO4: 0-10V/0-20mA								
	High-speed pulse input	1 channel: input range: 0-50kHz								
	High-speed pulse output	1 channel: output range: 0-50kHz								
Protection function	System protection	Overcurrent, overvoltage, undervoltage, motor overload, VFD overload, phase loss, overheating, temperature controller fault, access fault, communication fault, etc.								
	Unit protection	Undervoltage, overvoltage, power supply, overheating, input phase loss, VCE fault, power supply fault, communication fault, bypass failure, etc.								
Others	HMI	Touch screen								
	Communication mode	Support Modbus protocol (with standard RS485 interface), Pro2bus, Pro2net, and Ethernet								
	Installation method	Cabinet mounting								
	Protection degree	Standard IP30 (Others optional)								
	Noise degree	≤75dB								
	Feed in and out method	Bottom in and out; other methods are optiona								
	Cooling	Forced-air cooling								
	Control power supply	AC 380V±10% (Others optional)								
	MTBF	100000h								
	Environment temperature	-5°C~+40°C, derate 1.5% for every additional 1°C if the temperature is above 40°C and the maximum temperature is 50°C; run without load if the temperature reaches 60°C.								
	Environment humidity	5%~95%, no condensation								
	Altitude	Below 1000m; derate 1% for every additional 100m if the altitude is above 1000m								
	Storage	Keep away from dust, direct sunlight, flammable or corrosive gas, oil, steam and vibration								
Vibration amplitude	0.59g below									

Standard terminals

Note: The figure only displays part of I/O terminal functions of system signals and each function is programmable.

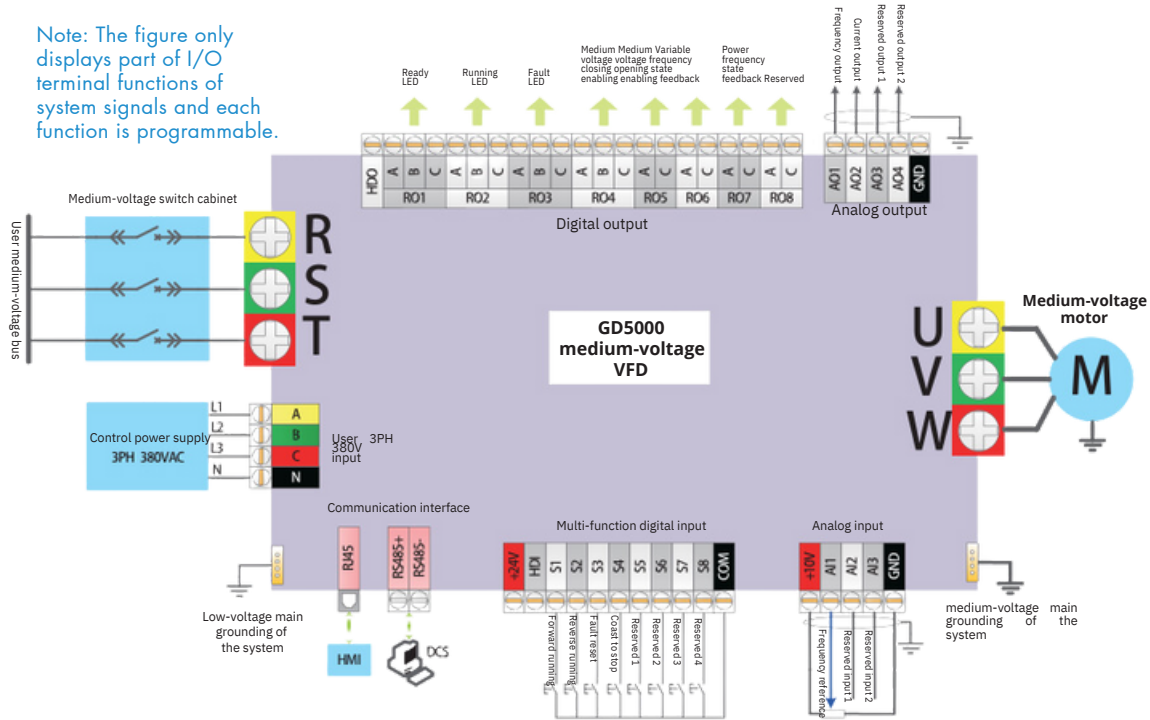

Product model instruction

Two-quadrant topology

GD5000-A□□□□-□□-XXXX

① ② ③ ④ ⑤ ⑥ ⑦ ⑧

①	High-voltage product series name	GD5000: High-performance high-voltage VFD
②	Product type	A: Asynchronous vector product (AM) B: Synchronous vector product (SM)
③	Rated capacity	0500: 500kVA
④	Voltage degree	03: 3kV 3.3: 3.3kV 4.16: 4.16kV 06: 6kV 10: 10kV 11: 11kV
⑤	Lot No.	D: Dual-side maintenance S: Front maintenance L: Integrated machine
⑥	Lot No.	R: Energy feedback system X: If no, default
⑦	Lot No.	C: Bypass system with unit contactor X: If no, default
⑧	Lot No.	Lot No. for special products based on the specific industry or for other purposes

For example:
GD5000-A3150-06-D indicates GD5000 series high-performance medium-voltage VFD, vector control, drive asynchronous motor, rated capacity 3150kVA, dual-side maintenance, and two-quadrant operation.

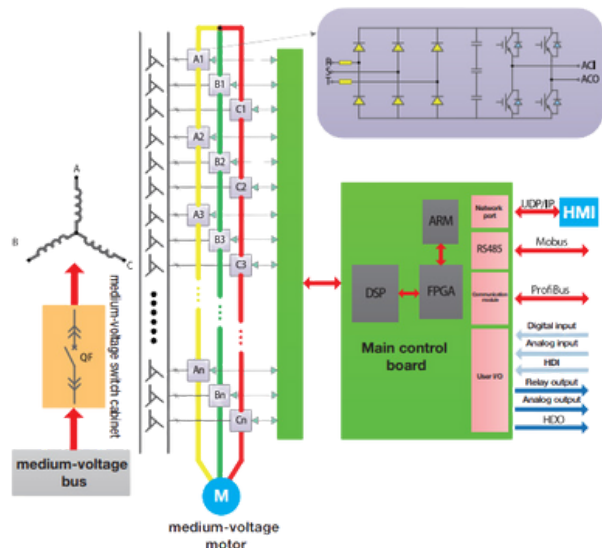

Two-quadrant selection table

3kV series

VFD model	Rated power (kW)	Rated current (A)	Dimensions W*D*H (mm)	Weight (kg)
GD5000-A0280-03-S	220	54	3200X1200X2720	2416
GD5000-A0315-03-S	250	61	3200X1200X2720	2466
GD5000-A0355-03-S	280	68	3200X1200X2720	2506
GD5000-A0400-03-S	315	77	3800X1200X2720	2731
GD5000-A0450-03-S	355	87	3800X1200X2720	2881
GD5000-A0500-03-S	400	96	3800X1200X2720	2961
GD5000-A0560-03-S	450	108	4000X1200X2720	3149
GD5000-A0630-03-S	500	121	4000X1200X2720	3299
GD5000-A0710-03-S	560	137	4000X1200X2720	3349
GD5000-A0800-03-S	630	154	4000X1200X2720	3549
GD5000-A0900-03-S	710	173	4000X1200X2720	3790
GD5000-A1000-03-S	800	192	4000X1200X2720	3890
GD5000-A1120-03-S	900	216	4000X1200X2720	4030
GD5000-A1250-03-S	1000	241	4000X1200X2720	4380
GD5000-A1400-03-D	1120	269	5000X1500X2820	5560
GD5000-A1600-03-D	1250	308	5000X1500X2820	5810
GD5000-A1800-03-D	1400	346	5400X1500X2820	6710
GD5000-A2000-03-D	1600	385	5400X1500X2820	7010
GD5000-A2240-03-D	1800	431	5800X1500X2820	7760
GD5000-A2500-03-D	2000	481	5800X1500X2820	8160
GD5000-A2800-03-D	2240	539	5800X1500X2820	8860
GD5000-A3150-03-D	2500	609	5800X1500X2820	9300
GD5000-A3550-03-D	2800	722	5800X1500X2820	10160

Two-quadrant selection table

3.3kV series

VFD model	Rated power (kW)	Rated current (A)	Dimensions W*D*H (mm)	Weight (kg)
GD5000-A0280-3.3-S	220	49	3200X1200X2660	2283
GD5000-A0315-3.3-S	250	55	3200X1200X2720	2416
GD5000-A0355-3.3-S	280	62	3200X1200X2720	2466
GD5000-A0400-3.3-S	315	70	3200X1200X2720	2506
GD5000-A0450-3.3-S	355	79	3800X1200X2720	2731
GD5000-A0500-3.3-S	400	87	3800X1200X2720	2881
GD5000-A0560-3.3-S	450	98	3800X1200X2720	2961
GD5000-A0630-3.3-S	500	110	4000X1200X2720	3149
GD5000-A0710-3.3-S	560	124	4000X1200X2720	3299
GD5000-A0800-3.3-S	630	140	4000X1200X2720	3349
GD5000-A0900-3.3-S	710	157	4000X1200X2720	3549
GD5000-A1000-3.3-S	800	175	4000X1200X2720	3790
GD5000-A1120-3.3-S	900	196	4000X1200X2720	3890
GD5000-A1250-3.3-S	1000	219	4000X1200X2720	4030
GD5000-A1400-3.3-S	1120	245	4000X1200X2720	4380
GD5000-A1600-3.3-D	1250	280	5000X1500X2820	5560
GD5000-A1800-3.3-D	1400	315	5000X1500X2820	5810
GD5000-A2000-3.3-D	1600	350	5400X1500X2820	6710
GD5000-A2240-3.3-D	1800	392	5400X1500X2820	7010
GD5000-A2500-3.3-D	2000	437	5800X1500X2820	7760
GD5000-A2800-3.3-D	2240	490	5800X1500X2820	8160
GD5000-A3150-3.3-D	2500	551	5800X1500X2820	8860
GD5000-A3550-3.3-D	2800	620	5800X1500X2820	9650
GD5000-A4000-3.3-D	3150	722	5800X1500X2820	10200

Two-quadrant selection table

4.16kV series

VFD model	Rated power (kW)	Rated current (A)	Dimensions W*D*H (mm)	Weight (kg)
GD5000-A0315-4.16-S	250	44	3600X1200X2720	3405
GD5000-A0355-4.16-S	280	49	3600X1200X2720	3455
GD5000-A0400-4.16-S	315	56	3600X1200X2720	3638
GD5000-A0450-4.16-S	355	62	3600X1200X2720	3718
GD5000-A0500-4.16-S	400	69	3600X1200X2720	3798
GD5000-A0560-4.16-S	450	78	4200X1200X2720	4053
GD5000-A0630-4.16-S	500	87	4200X1200X2720	4353
GD5000-A0710-4.16-S	560	99	4200X1200X2720	4483
GD5000-A0800-4.16-S	630	111	4600X1200X2720	4743
GD5000-A0900-4.16-S	710	125	4600X1200X2720	5093
GD5000-A1000-4.16-S	800	139	4600X1200X2720	5243
GD5000-A1120-4.16-S	900	155	4600X1200X2720	5593
GD5000-A1250-4.16-S	1000	173	4600X1200X2720	5975
GD5000-A1400-4.16-S	1120	194	4600X1200X2720	6425
GD5000-A1600-4.16-S	1250	222	4600X1200X2720	6865
GD5000-A1800-4.16-S	1400	236	4600X1200X2720	7515
GD5000-A2000-4.16-D	1600	278	5000X1500X2820	8910
GD5000-A2240-4.16-D	1800	311	5000X1500X2820	9410
GD5000-A2500-4.16-D	2000	347	5400X1500X2820	10860
GD5000-A2800-4.16-D	2240	389	5400X1500X2820	11510
GD5000-A3150-4.16-D	2500	437	5800X1500X2820	13210
GD5000-A3550-4.16-D	2800	493	5800X1500X2820	14110
GD5000-A4000-4.16-D	3150	555	5800X1500X2820	15010
GD5000-A4500-4.16-D	3550	624	6200X1500X2820	16000
GD5000-A5000-4.16-D	4000	722	6200X1500X2820	17010

Two-quadrant selection table

6kV series

VFD model	Rated power (kW)	Rated current (A)	Dimensions W*D*H (mm)	Weight (kg)
GD5000-A0400-06-S	315	38	3800X1200X2660	2965
GD5000-A0500-06-S	400	48	3800X1200X2660	3035
GD5000-A0560-06-S	450	54	3800X1200X2660	3170
GD5000-A0630-06-S	500	61	3800X1200X2660	3320
GD5000-A0710-06-S	560	68	3800X1200X2660	3370
GD5000-A0800-06-S	630	77	4400X1200X2660	3635
GD5000-A0900-06-S	710	87	4400X1200X2660	3785
GD5000-A1000-06-S	800	96	4400X1200X2660	3885
GD5000-A1120-06-S	900	108	4800X1200X2720	4268
GD5000-A1250-06-S	1000	120	4800X1200X2660	4408
GD5000-A1400-06-S	1120	135	4800X1200X2660	4758
GD5000-A1600-06-D	1250	154	4650X1500X2660	5058
GD5000-A1800-06-D	1400	173	4650X1500X2720	5610
GD5000-A2000-06-D	1600	192	4650X1500X2720	5810
GD5000-A2240-06-D	1800	216	4650X1500X2720	6060
GD5000-A2500-06-D	2000	241	4650X1500X2720	6560
GD5000-A2800-06-D	2240	269	5800X1200X2820	7550
GD5000-A3150-06-D	2500	303	5800X1200X2820	8350
GD5000-A3550-06-D	2800	342	6400X1200X2820	9750
GD5000-A4000-06-D	3150	385	6800X1200X2820	10000
GD5000-A4500-06-D	3550	433	7400X1200X2820	11600
GD5000-A5000-06-D	4000	481	7400X1200X2820	12000
GD5000-A5600-06-D	4500	539	7600X1200X2820	13180
GD5000-A6300-06-D	5000	606	8200X1500X2820	15510
GD5000-A7500-06-D	6000	722	8200X1500X2820	16110

Two-quadrant selection table

6.6kV series

VFD model	Rated power (kW)	Rated current (A)	Dimensions W*D*H (mm)	Weight (kg)
GD5000-A0400-6.6-S	315	35	4000X1200X2720	3026
GD5000-A0450-6.6-S	355	39	4000X1200X2720	3056
GD5000-A0500-6.6-S	400	44	4000X1200X2720	3096
GD5000-A0560-6.6-S	450	49	4000X1200X2720	3126
GD5000-A0630-6.6-S	500	55	4000X1200X2720	3402
GD5000-A0710-6.6-S	560	62	4000X1200X2720	3482
GD5000-A0800-6.6-S	630	70	4000X1200X2720	3552
GD5000-A0900-6.6-S	710	79	4600X1200X2720	3917
GD5000-A1000-6.6-S	800	87	4600X1200X2720	4017
GD5000-A1120-6.6-S	900	98	4600X1200X2720	4117
GD5000-A1250-6.6-D	1000	109	4650X1500X2650	4597
GD5000-A1400-6.6-D	1120	122	4650X1500X2650	4657
GD5000-A1600-6.6-D	1250	140	4650X1500X2650	5077
GD5000-A1800-6.6-D	1400	157	4650X1500X2650	5301
GD5000-A2000-6.6-D	1600	175	4650X1500X2650	5693
GD5000-A2240-6.6-D	1800	196	4650X1500X2650	6050
GD5000-A2500-6.6-D	2000	219	4650X1500X2650	6284
GD5000-A2800-6.6-D	2240	245	4650X1500X2650	6564
GD5000-A3150-6.6-D	2500	276	5800X1500X2820	8425
GD5000-A3550-6.6-D	2800	311	5800X1500X2820	8725
GD5000-A4000-6.6-D	3150	350	6800X1500X2820	9625
GD5000-A4500-6.6-D	3550	394	6800X1500X2820	10825
GD5000-A5000-6.6-D	4000	437	7400X1500X2820	12975
GD5000-A5600-6.6-D	4500	490	7600X1500X2820	13755
GD5000-A6300-6.6-D	5000	551	7600X1500X2820	14555
GD5000-A7100-6.6-D	5600	620	7600X1500X2820	15355
GD5000-A8000-6.6-D	6300	722	10000X1500X2820	20000

Two-quadrant selection table

10kV series

VFD model	Rated power (kW)	Rated current (A)	Dimensions W*D*H (mm)	Weight (kg)
GD5000-A0500-10-S	400	29	4600X1200X2660	3550
GD5000-A0560-10-S	450	32	4600X1200X2660	3550
GD5000-A0710-10-S	560	41	4800X1200X2660	3960
GD5000-A0800-10-S	630	46	4800X1200X2720	4070
GD5000-A0900-10-S	710	52	4800X1200X2720	4366
GD5000-A1000-10-S	800	58	4800X1200X2660	4426
GD5000-A1120-10-S	900	65	4800X1200X2660	4776
GD5000-A1250-10-S	1000	72	4800X1200X2660	4976
GD5000-A1400-10-S	1120	81	5200X1200X2720	5271
GD5000-A1600-10-S	1250	92	5200X1200X2720	5421
GD5000-A1700-10-S	1400	98	5200X1200X2720	5621
GD5000-A2000-10-S	1600	115	5800X1200X2720	6481
GD5000-A2240-10-S	1800	129	6200X1500X2720	6876
GD5000-A2500-10-S	2000	144	6200X1500X2720	7276
GD5000-A2800-10-D	2240	162	5050X1500X2720	7576
GD5000-A3150-10-D	2500	182	5050X1500X2720	8210
GD5000-A3550-10-D	2800	205	5050X1500X2720	9310
GD5000-A4000-10-D	3150	231	5050X1500X2720	10030
GD5000-A4500-10-D	3550	260	7000X1500X2820	10960
GD5000-A5000-10-D	4000	289	7000X1500X2820	11260
GD5000-A5600-10-D	4500	323	7200X1500X2820	11940
GD5000-A6300-10-D	5000	364	8000X1500X2820	14340
GD5000-A7100-10-D	5600	410	8800X1500X2820	15990
GD5000-A7500-10-D	6000	433	11200X1500X2820	19880
GD5000-A8000-10-D	6300	462	11200X1500X2820	21080
GD5000-A9000-10-D	7100	520	11200X1500X2820	22280
GD5000-A10000-10-D	8000	577	11200X1500X2820	23080
GD5000-A11200-10-D	9000	647	12000X1500X2820	26020
GD5000-A12500-10-D	10000	722	12000X1500X2820	26820

Two-quadrant selection table

11kV series

VFD model	Rated power (kW)	Rated current (A)	Dimensions W*D*H (mm)	Weight (kg)
GD5000-A0500-11	400	26	4800X1200X2720	3699
GD5000-A0560-11	450	29	4800X1200X2720	3749
GD5000-A0630-11	500	33	4800X1200X2720	3849
GD5000-A0710-11	560	37	5000X1200X2720	4129
GD5000-A0800-11	630	42	5000X1200X2720	4179
GD5000-A0900-11	710	47	5000X1200X2720	4279
GD5000-A1000-11	800	52	5000X1200X2660	4608
GD5000-A1120-11	900	59	5000X1200X2660	4918
GD5000-A1250-11	1000	66	5000X1200X2660	5118
GD5000-A1400-11	1120	73	5000X1200X2660	5368
GD5000-A1600-11	1250	84	5400X1200X2720	5503
GD5000-A1800-11	1400	94	5400X1200X2720	5843
GD5000-A2000-11	1600	105	4650X1500X2650	5906
GD5000-A2240-11	1800	118	4650X1500X2650	6211
GD5000-A2500-11	2000	131	5050X1500X2650	6656
GD5000-A2800-11	2240	147	5050X1500X2650	6977
GD5000-A3150-11	2500	165	5050X1500X2650	7219
GD5000-A3550-11	2800	186	5050X1500X2650	8355
GD5000-A4000-11	3150	210	5050X1500X2650	8619
GD5000-A4500-11	3550	236	5050X1500X2650	9698
GD5000-A5000-11	4000	262	7800X1500X2820	12005
GD5000-A5600-11	4500	294	8000X1500X2820	14385
GD5000-A6300-11	5000	331	9000X1500X2820	16885
GD5000-A7000-11	5600	367	9000X1500X2820	17585
GD5000-A8000-11	6300	420	12600X1500X2820	21765
GD5000-A9000-11	7100	472	12600X1500X2820	23265
GD5000-A10000-11	8000	525	12600X1500X2820	25665
GD5000-A11200-11	9000	587	12600X1500X2820	28625
GD5000-A12500-11	10000	656	12600X1500X2820	30555
GD5000-A13500-11	10800	722	12600X1500X2820	33265

Four-quadrant topology

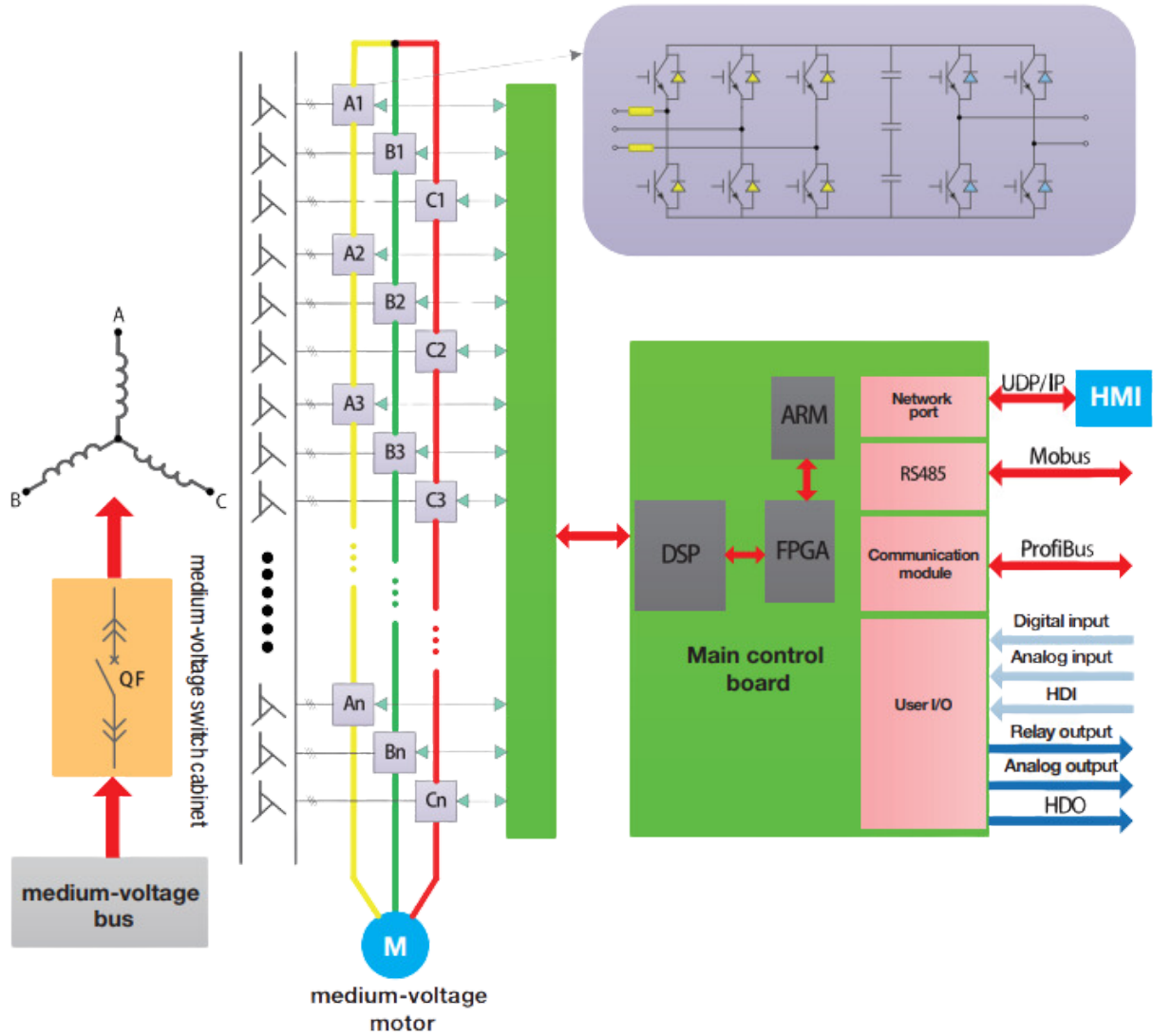

Four-quadrant selection table

6kV series

VFD model	Rated power (kW)	Rated current (A)	Dimensions W*D*H (mm)	Weight (kg)
GD5000-A0315-06	250	30	4400X1200X2660	3190
GD5000-A0355-06	280	34	4400X1200X2660	3240
GD5000-A0400-06	315	38	4400X1200X2660	3370
GD5000-A0450-06	355	43	4400X1200X2660	3420
GD5000-A0500-06	400	48	4400X1200X2660	3470
GD5000-A0560-06	450	54	4400X1200X2660	3520
GD5000-A0630-06	500	61	4800X1200X2660	3890
GD5000-A0710-06	560	68	4800X1200X2660	3990
GD5000-A0800-06	630	77	4800X1200X2660	4090
GD5000-A0900-06	710	87	4800X1200X2660	4290
GD5000-A1000-06	800	96	4800X1200X2660	4540
GD5000-A1120-06	900	108	4800X1200X2720	4755
GD5000-A1250-06	1000	120	4800X1200X2720	4945
GD5000-A1400-06	1120	135	4800X1200X2720	5145
GD5000-A1600-06	1250	154	4800X1200X2720	5345

Four-quadrant selection table

10kV series

VFD model	Rated power (kW)	Rated current (A)	Dimensions W*D*H (mm)	Weight (kg)
GD5000-A0400-10	315	23	5200X1200X2660	3877
GD5000-A0450-10	355	26	5200X1200X2660	3927
GD5000-A0500-10	400	29	5200X1200X2660	4057
GD5000-A0560-10	450	32	5200X1200X2660	4157
GD5000-A0630-10	500	36	5200X1200X2660	4207
GD5000-A0710-10	560	41	5200X1200X2660	4357
GD5000-A0800-10	630	46	5200X1200X2720	4547
GD5000-A0900-10	710	52	5200X1200X2720	4747
GD5000-A1000-10	800	58	5800X1200X2660	5261
GD5000-A1120-10	900	65	5800X1200X2660	5411
GD5000-A1250-10	1000	72	5800X1200X2660	5611
GD5000-A1400-10	1120	81	5800X1200X2720	5921
GD5000-A1600-10	1250	92	5800X1200X2720	6221
GD5000-A1700-10	1400	98	5800X1200X2720	6321
GD5000-A1900-10	1500	110	5800X1200X2720	6797
GD5000-A2000-10	1600	115	5800X1200X2720	6997
GD5000-A2120-10	1700	122	5800X1200X2720	7097
GD5000-A2240-10	1800	129	6200X1500X2720	7392
GD5000-A2500-10	2000	144	6200X1500X2720	7792

Outline drawing

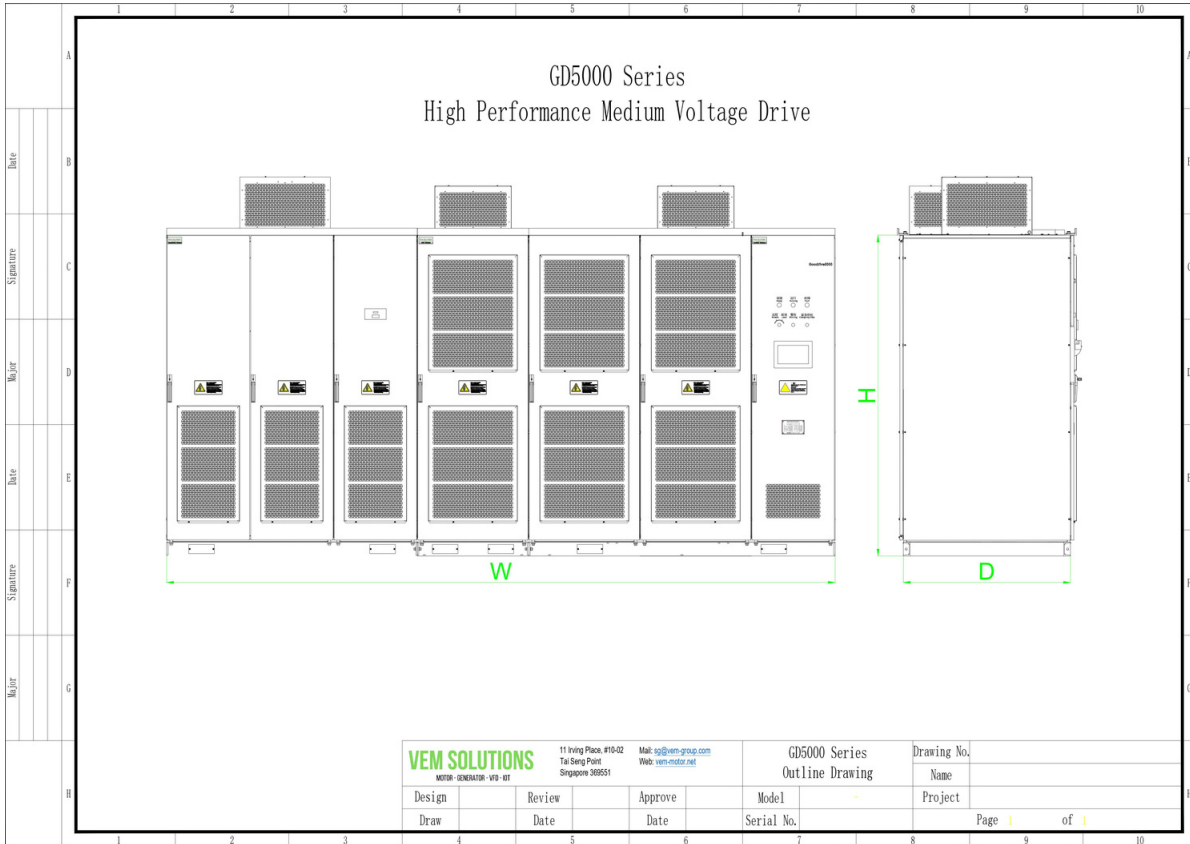

List of options and parts

Name	Model	Picture	Description
Bypass cabinet	GD5000-AS GD5000-MS		Manual bypass cabinet: 2 knife switches. Isolating automatic bypass cabinet: 2 knife switches, 3 contactors. Can select different bypass solutions according to on-site conditions.
Bumpless switching cabinet	GD5000-SS		Embedded with reactors, used for synchronous bumpless switching between power frequency and variable frequency
Remote operation cabinet	GD5000-CB		Used for on-site remote control, and the button functions and the displayed parameters can be customized as needed.
Communication card	GD5000-DP		Support Profibus-DP protocol
PG card	GD5000-PG		Encoder interface, support push-pull encoder A, B, Z signal input, differential, push-pull and open collector output.
Communication card	GD5000 set		Support Profinet protocol
Isolation grating	GD5000 set		Realize device input/output analog isolation, and enhance security and stability of the system.
Upper computer monitoring software	INVT Studio		Achieve the control of the upper computer on the VFD, and possess the functions of start/stop command, parameter read/write, fault diagnosis and oscilloscope. It can meet clients' non-standard requirements by modifying relative configuration files.



VEM SOLUTIONS

MOTOR - GENERATOR - VFD - IOT

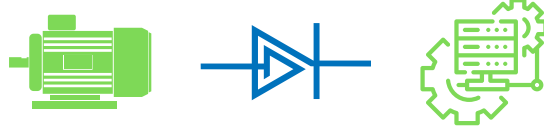

VEM MOTORS ASIA PTE LTD

SALES & SERVICE CONTACT ✓



+65 6873 1150



+82 051-791-1169



WWW.VEM-MOTOR.NET



WWW.VEM.CO.KR



SG@VEM-GROUP.COM



KR@VEM-GROUP.COM