

TSQU-1604

SET UP INSTRUCTIONS:

1. CONNECT BOTTOM AND TOP TUBES FOLLOWING THE LABELS
2. CONNECT SIDE TUBES
3. CLEAN THE FRAME AND PLACE THEM ON CLEAN PLACE
4. CAREFULLY REMOVE FABRIC COVER FROM BAG
5. PLACE COVER AROUND THE BOTTOM OF THE FRAME
6. PULL COVER CAREFULLY UP TO THE TOP
7. CLOSE ALL ZIPPERS
8. ADJUST FABRIC AROUND THE FRAME
9. CONNECT CABLE HARNESS TO THE EYEBOLTS
10. COMPLETELY TIGHTEN THREADED CONNECTORS

BREAK DOWN INSTRUCTIONS:
REVERSE SET-UP STEPS TO BREAKDOWN FRAME

- FABRIC CARE INSTRUCTIONS:**
1. UNZIP COVER ZIPPERS
 2. CAREFULLY REMOVE FABRIC COVER
 3. CLOSE ALL ZIPPERS
 4. FOLD OR ROLL NEATLY
 5. PLACE FABRIC IN COVER BAG

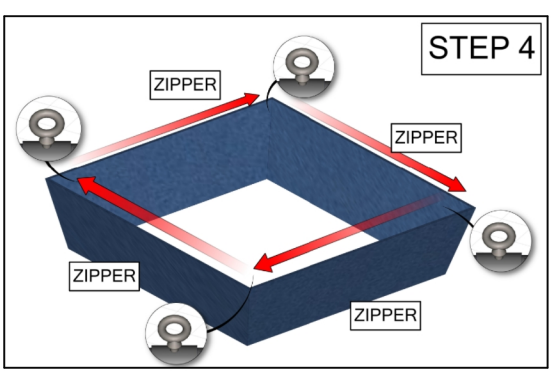
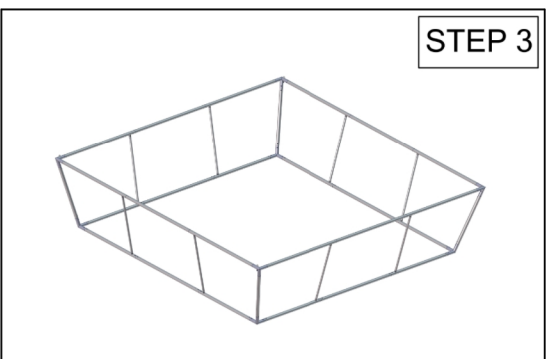
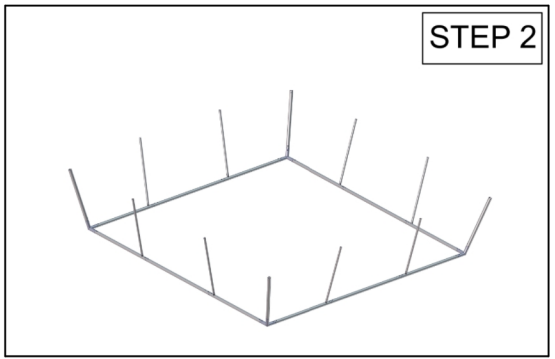
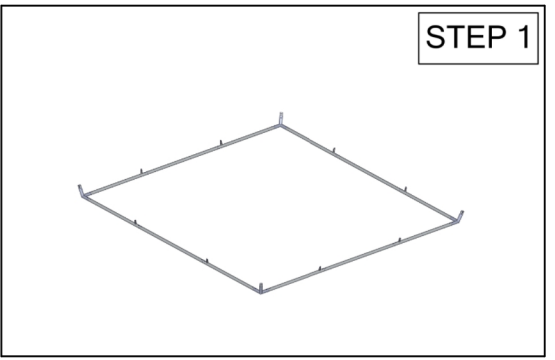
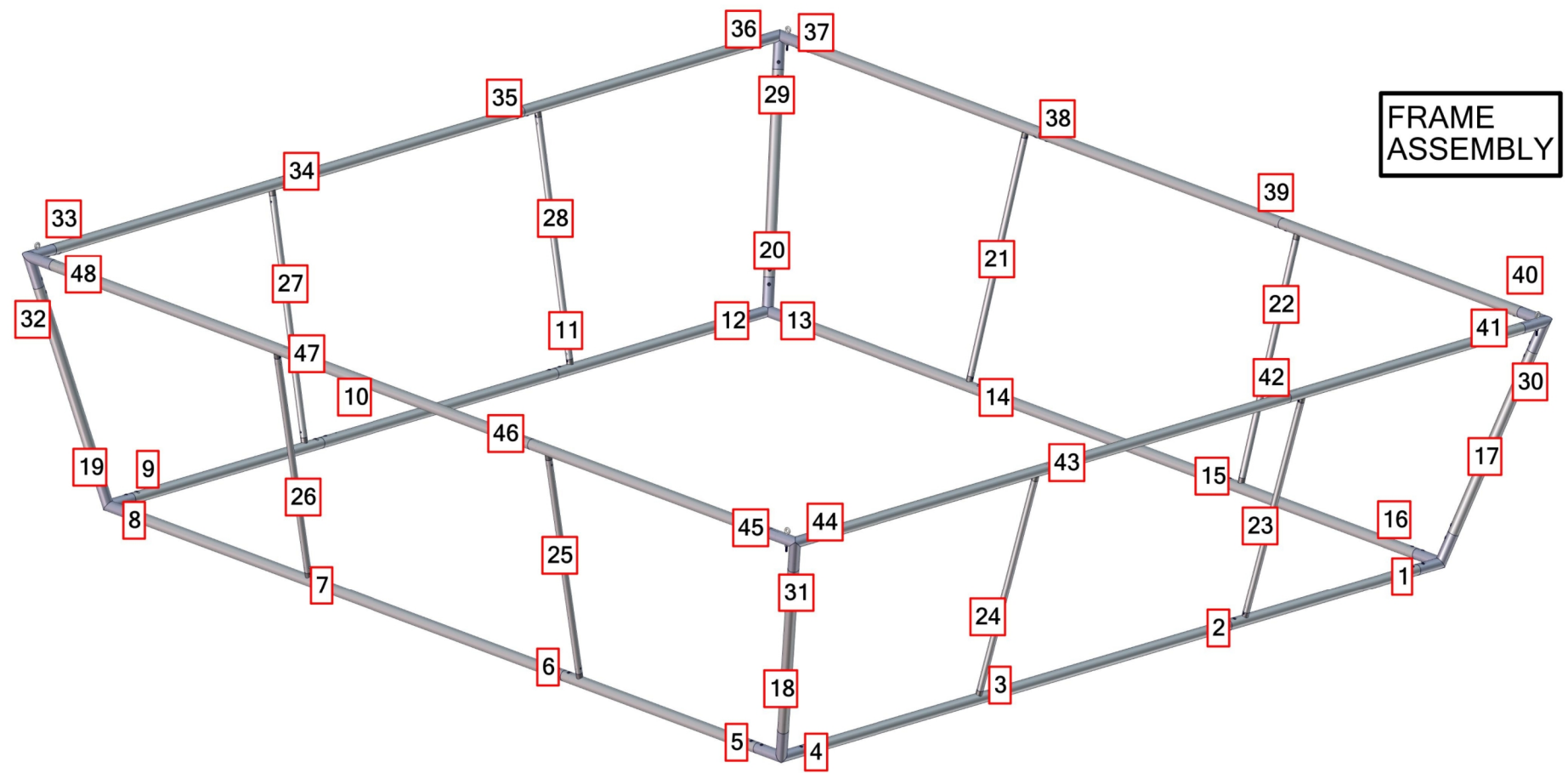

TOTAL WEIGHT: 122.7 (lbs)
MAX SIZE: 51.3 (in)
HARDWARE: 89.9 (lbs)
GRAPHIC: 36.5 (lbs)

QTY	CODE	DESCRIPTION
4	EYE BOLT	5/16-18X3.125" PARTIALLY THREADED EYE BOLT FOR 2" TUBING FABRIC STRUCTURES
4	CORNER-50-T-L	BOTTOM 50MM CORNER FOR TAPERED 4-SIDED
40	ES-50	EXPANDING SPIGOT FOR 50MM TUBE
8	SPRD-30-S10-4	30MM SPREADER FOR 50MM 4'H TAPERED 4-SIDED
4	SPRD-50-S3-4	50MM CORNER SPREADER FOR 4'H TAPERED 4-SIDED
4	CORNER-50-T-U	TOP 50MM CORNER FOR 50MM 4-SIDED TAPERED
8	TSQU-16-T2-4	50MM BOTTOM TUBE FOR 1604 TAPERED 4-SIDED
16	TSQU-16-T1	50MM TOP TUBE FOR 16' TAPERED 4-SIDED

