

TSQU-1205

SET UP INSTRUCTIONS:

1. CONNECT BOTTOM AND TOP TUBES FOLLOWING THE LABELS
2. CONNECT SIDE TUBES
3. CLEAN THE FRAME AND PLACE THEM ON CLEAN PLACE
4. CAREFULLY REMOVE FABRIC COVER FROM BAG
5. PLACE COVER AROUND THE BOTTOM OF THE FRAME
6. PULL COVER CAREFULLY UP TO THE TOP
7. CLOSE ALL ZIPPERS
8. ADJUST FABRIC AROUND THE FRAME
9. CONNECT CABLE HARNESS TO THE EYEBOLTS
10. COMPLETELY TIGHTEN THREADED CONNECTORS

BREAK DOWN INSTRUCTIONS:
REVERSE SET-UP STEPS TO BREAKDOWN FRAME

FABRIC CARE INSTRUCTIONS:

1. UNZIP COVER ZIPPERS
2. CAREFULLY REMOVE FABRIC COVER
3. CLOSE ALL ZIPPERS
4. FOLD OR ROLL NEATLY
5. PLACE FABRIC IN COVER BAG

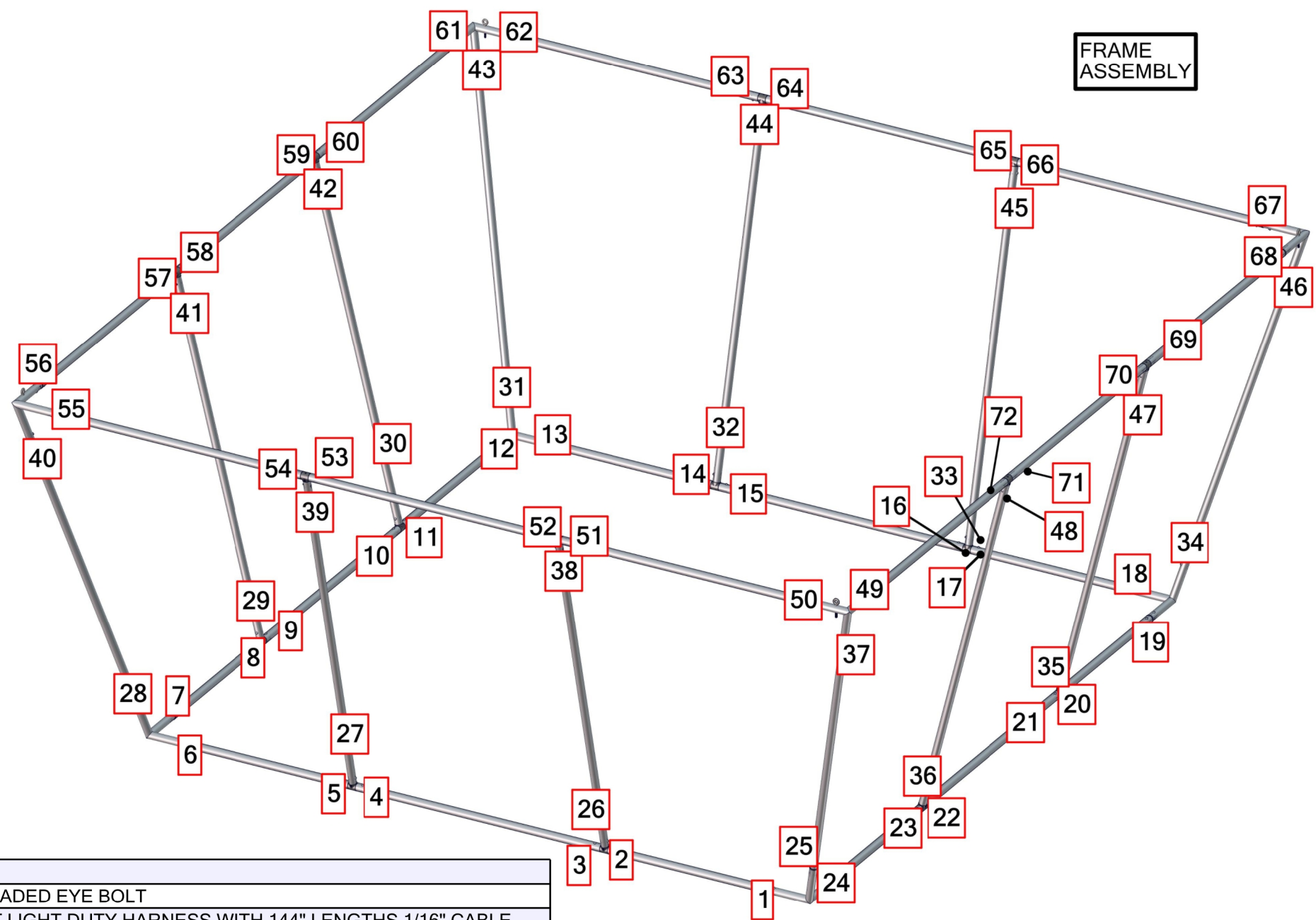

TOTAL WEIGHT: 78.0 (lbs)
MAX SIZE: 47.0 (in)
HARDWARE: 39.7 (lbs)
GRAPHIC: 34.3 (lbs)

QTY	CODE	DESCRIPTION
4	EYEBOLTS-0.25-20-2	2" SHANK 0.25-20 THREADED EYE BOLT
1	CH-SP4-LD-12	4-CABLE SINGLE POINT LIGHT DUTY HARNESS WITH 144" LENGTHS 1/16" CABLE
4	CORNER-30-90-T-L	LOWER TUBE FOR 6' HIGH TAPERED FOUR SIDED HANGING FABRIC STRUCTURES
4	CORNER-30-90-T-U	LOWER TUBE FOR 2' HIGH TAPERED FOUR SIDED HANGING FABRIC STRUCTURES
4	SPRD-30-S6-T5	LOWER TUBE FOR 5' HIGH TAPERED FOUR SIDED HANGING FABRIC STRUCTURES
8	SPRD-30-S9-5	LOWER TUBE FOR 5' HIGH TAPERED FOUR SIDED HANGING FABRIC STRUCTURES
24	TC-30-S	INLINE CONNECTOR FOR 30MM TUBING
16	TC-30-T	T JUNCTION FOR 30MM TUBING
16	TSQU-12-T1	UPPER TUBE FOR 10' WIDE TAPERED FOUR SIDED HANGING FABRIC STRUCTURES
8	TSQU-12-T5	LOWER TUBE FOR 5' HIGH TAPERED FOUR SIDED HANGING FABRIC STRUCTURES

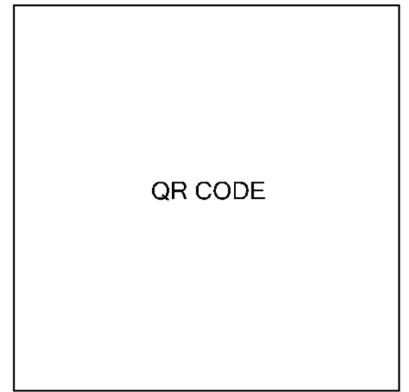
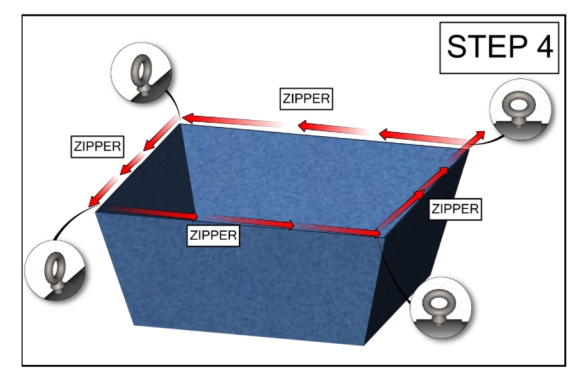
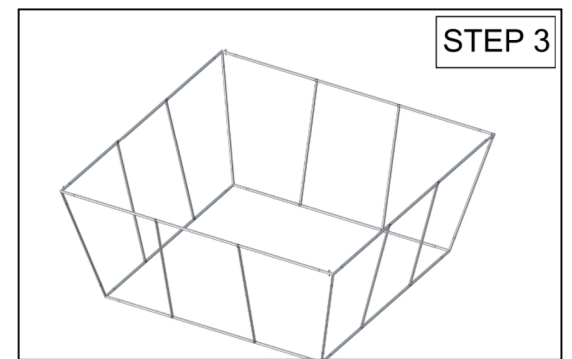
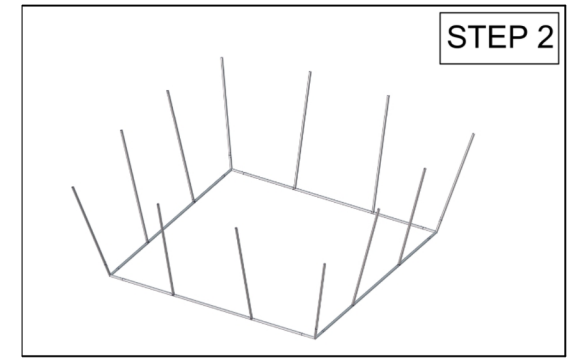
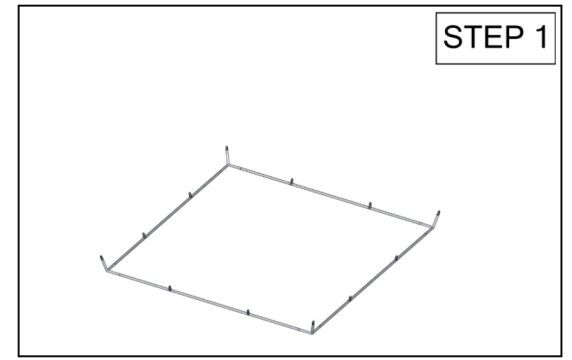
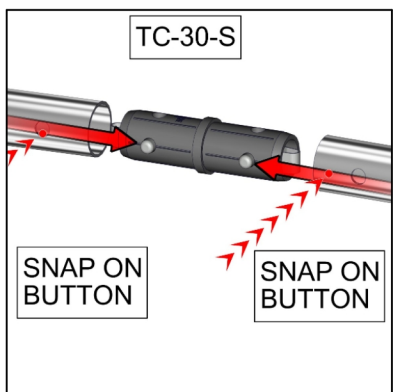
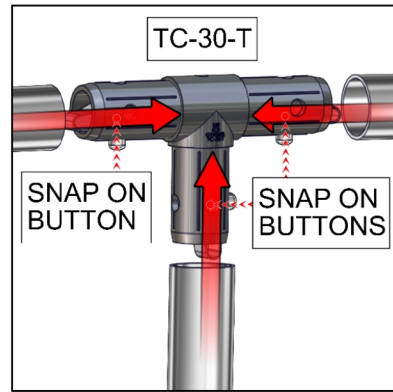

Set-up Video