

# TSQU-1203

**SET UP INSTRUCTIONS:**

1. CONNECT BOTTOM AND TOP TUBES FOLLOWING THE LABELS
2. CONNECT SIDE TUBES
3. CLEAN THE FRAME AND PLACE THEM ON CLEAN PLACE
4. CAREFULLY REMOVE FABRIC COVER FROM BAG
5. PLACE COVER AROUND THE BOTTOM OF THE FRAME
6. PULL COVER CAREFULLY UP TO THE TOP
7. CLOSE ALL ZIPPERS
8. ADJUST FABRIC AROUND THE FRAME
9. CONNECT CABLE HARNESS TO THE EYEBOLTS
10. COMPLETELY TIGHTEN THREADED CONNECTORS

**BREAK DOWN INSTRUCTIONS:**  
REVERSE SET-UP STEPS TO BREAKDOWN FRAME

- FABRIC CARE INSTRUCTIONS:**
1. UNZIP COVER ZIPPERS
  2. CAREFULLY REMOVE FABRIC COVER
  3. CLOSE ALL ZIPPERS
  4. FOLD OR ROLL NEATLY
  5. PLACE FABRIC IN COVER BAG

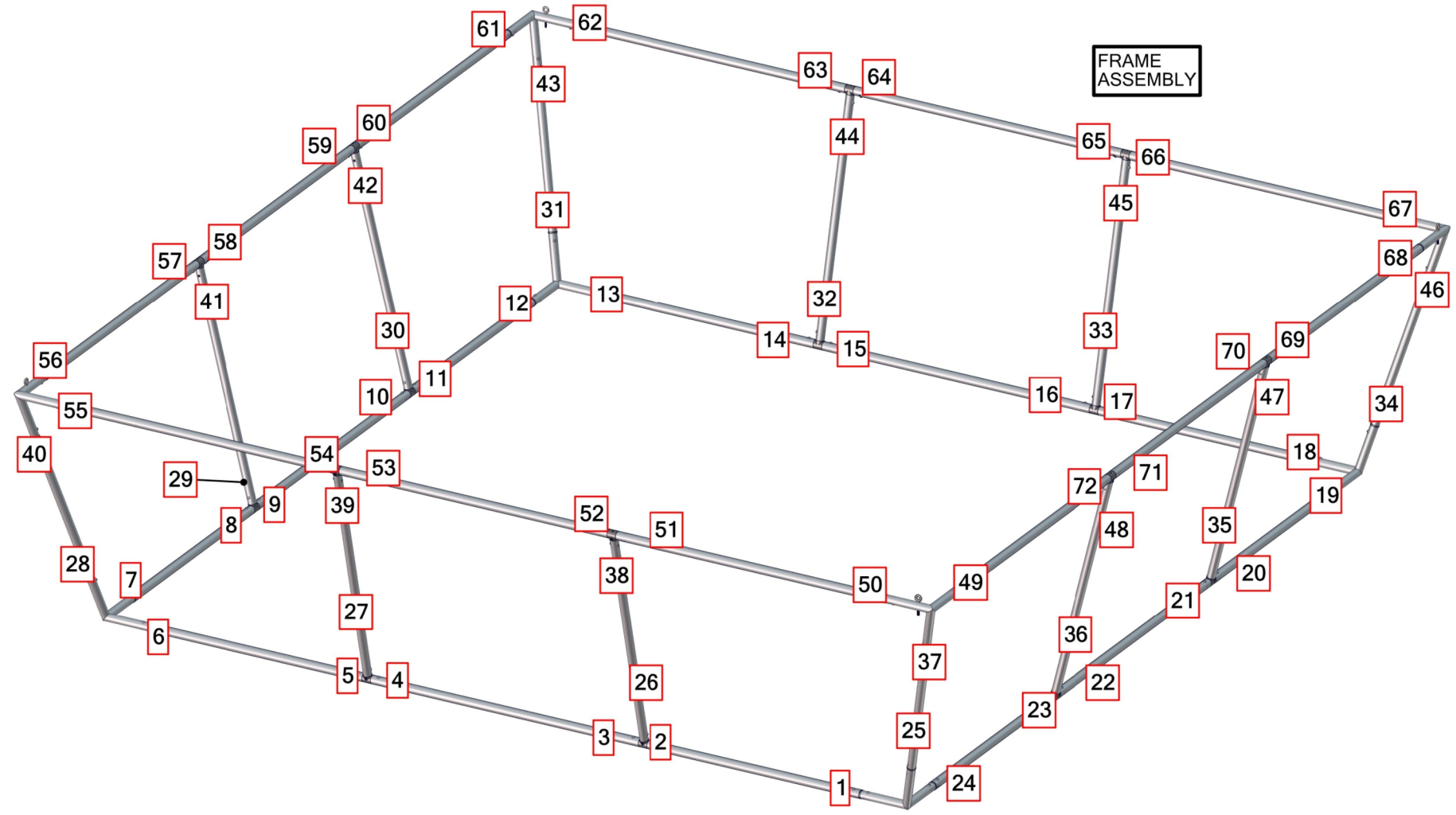

**TOTAL WEIGHT:58.5 (lbs)**  
**MAX SIZE:47.0 (in)**  
**HARDWARE:34.5 (lbs)**  
**GRAPHIC:20.6 (lbs)**

| QTY | CODE               | DESCRIPTION   |
|-----|--------------------|---|
| 4   | EYEBOLTS-0.25-20-2 | 2" SHANK 0.25-20 THREADED EYE BOLT                                    |
| 1   | CH-SP4-LD-12       | 4-CABLE SINGLE POINT LIGHT DUTY HARNESS WITH 144" LENGTHS 1/16" CABLE |
| 4   | CORNER-30-90-T-L   | LOWER TUBE FOR 6' HIGH TAPERED FOUR SIDED HANGING FABRIC STRUCTURES   |
| 4   | CORNER-30-90-T-U   | LOWER TUBE FOR 2' HIGH TAPERED FOUR SIDED HANGING FABRIC STRUCTURES   |
| 4   | SPRD-30-S6-T3      | LOWER TUBE FOR 3' HIGH TAPERED FOUR SIDED HANGING FABRIC STRUCTURES   |
| 8   | SPRD-30-S9-3       | LOWER TUBE FOR 3' HIGH TAPERED FOUR SIDED HANGING FABRIC STRUCTURES   |
| 24  | TC-30-S            | INLINE CONNECTOR FOR 30MM TUBING                                      |
| 16  | TC-30-S            | INLINE CONNECTOR FOR 30MM TUBING                                      |
| 16  | TC-30-T            | T JUNCTION FOR 30MM TUBING  |
| 4   | TC-30-T-EYEBOLT    | T JUNCTION FOR 30MM TUBING  |
| 4   | TC-30-T            | T JUNCTION FOR 30MM TUBING  |
| 16  | TSQU-12-T1         | UPPER TUBE FOR 10' WIDE TAPERED FOUR SIDED HANGING FABRIC STRUCTURES  |
| 8   | TSQU-12-T3         | LOWER TUBE FOR 3' HIGH TAPERED FOUR SIDED HANGING FABRIC STRUCTURES   |

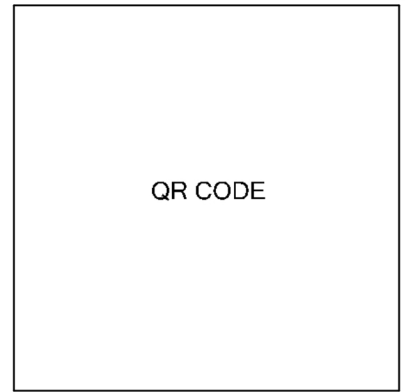
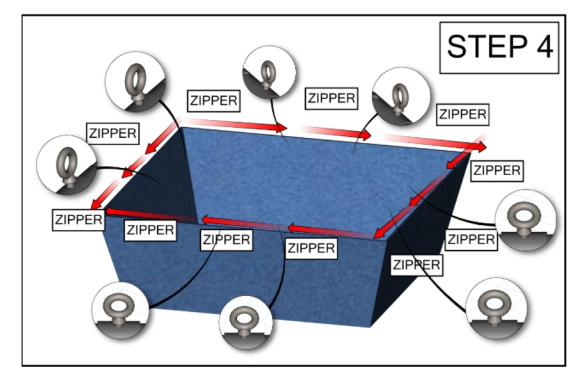
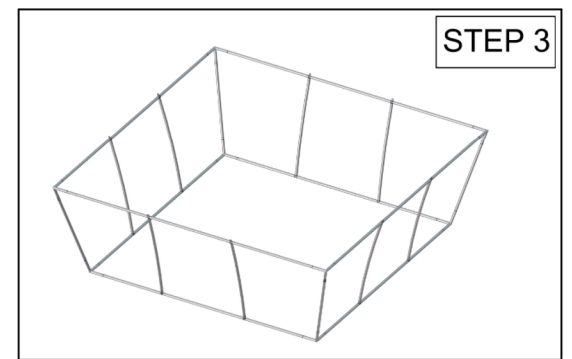
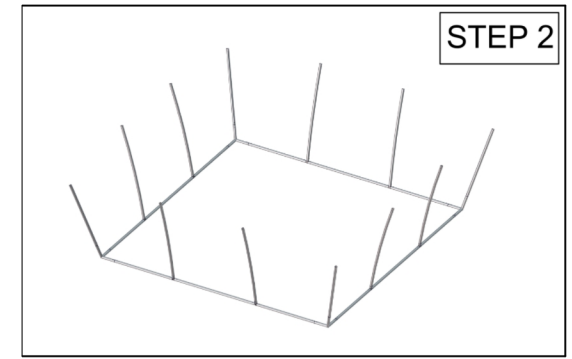
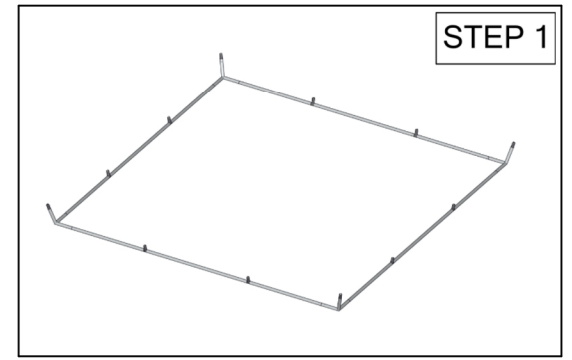
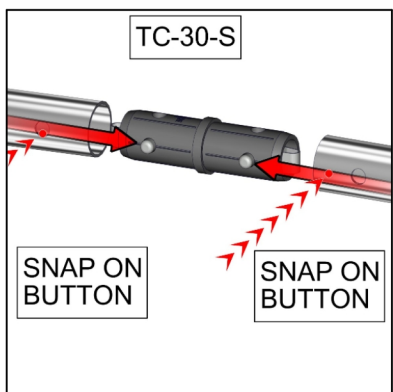
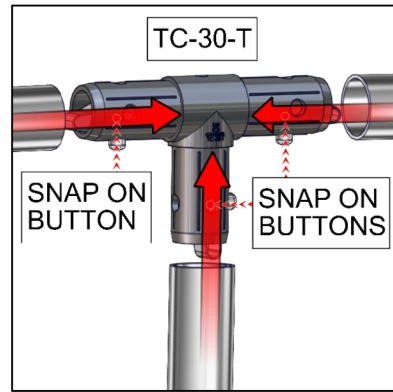

**Set-up Video**