

# 'S' Curve Hanging Structures

## SSB

S Curve tension fabric hanging structures are made in the USA and are of the utmost quality and durability. State-of-the-art zipper pillowcase dye-sublimated stretch fabric coverings are combined with advanced, lightweight aluminum structures to provide unique design, functionality, and style. Hanging structures are offered in a wide variety of shapes and sizes. Stretch fabric graphics are hand-sewn, durable and dry-cleanable.

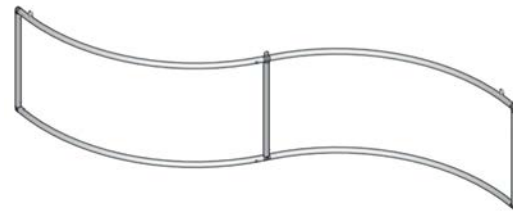

Frame



Single sided & double sided graphic



30mm tube push-button connector



50mm tube spigot connector

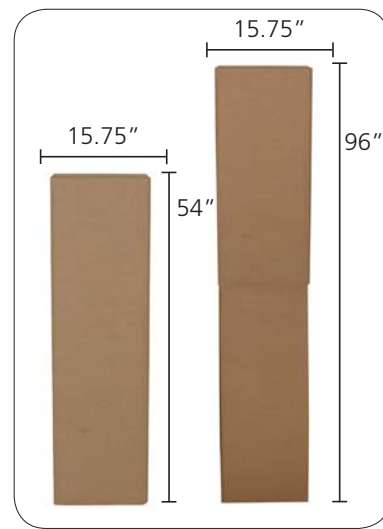

Hanging Structure standard box

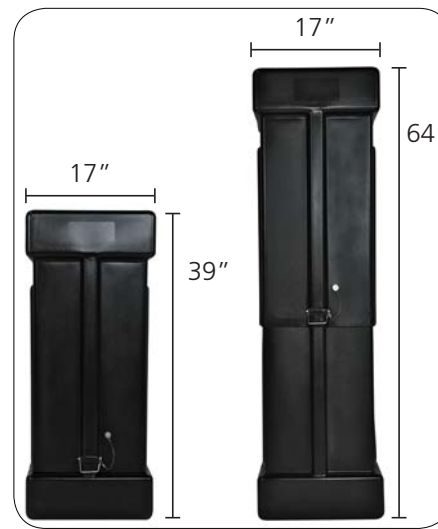

OCE Expandable Display Case - Available as an upgrade

## features and benefits:

- S curve hanging structures come in 8', 10', 12', 14', 16', 18' & 20' width configurations at varying heights of 2', 3', 4', 5' & 6'
- Shapes 12' width and under are constructed with 30mm (1<sup>1/8</sup>") tubes and push-button connectors for simple assembly
- Shapes 14' width and over are constructed with 50mm (2") tubes and internal expanding spigot connectors for unmatched structural integrity
- Engineer certified (structural engineer certificate available upon request)
- Zippered pillowcase fabric graphic options include: unprinted (white and black), single-sided (outer panel printed only) and double-sided (inner and outer panels printed).
- All pillowcase graphics come standard with opaque liner
- Comes standard with hanging hardware, bags and heavy-duty shipping and storage box(es)
- OCE Expandable rugged molded shipping cases available as an upgrade
- Collapses to a fraction of its size
- Easy to store and ship
- Quick to set up

## dimensions:

Hardware can be found on page 2

Graphic dimensions can be found in the graphic templates, which can be viewed at [www.exhibitors-handbook.com/graphic-templates](http://www.exhibitors-handbook.com/graphic-templates)

Graphic Material:

5 oz. Soft Knit Dye-sublimated zipper pillowcase fabric

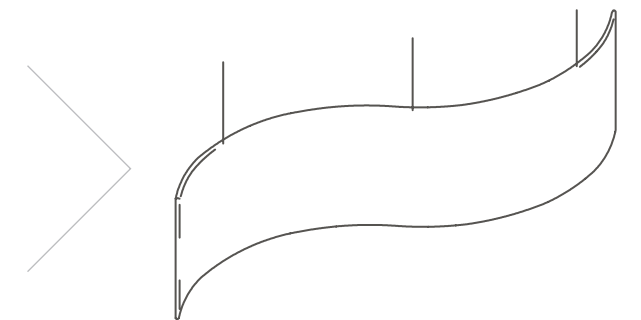
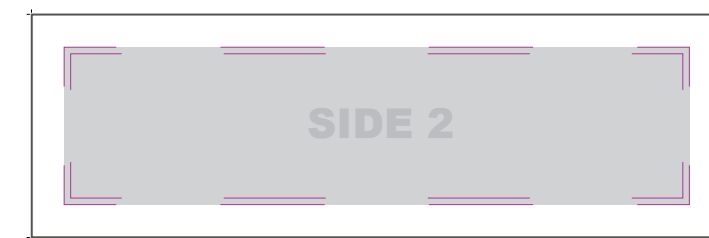
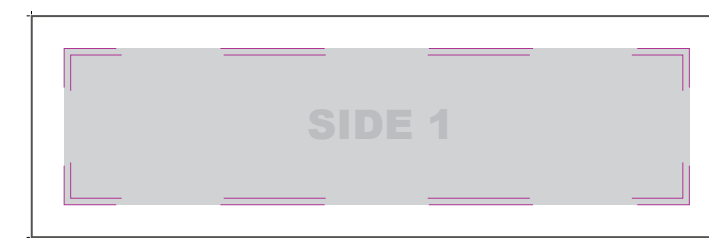

We are continually improving and modifying our product range and reserve the right to vary the specifications without prior notice. All dimensions and weights quoted are approximate and we accept no responsibility for variance. E&OE. See Graphic Templates for graphic bleed specifications.

SSB-8' WIDTH							
HEIGHT	HARDWARE CODE	# OF BOXES OR CASES	UNPRINTED GRAPHIC CODE	SINGLE-SIDED GRAPHIC CODE	OUTER GRAPHIC SPECS	DOUBLE-SIDED GRAPHIC CODE	INSIDE GRAPHIC SPECS
2'	SSB-0802	1	SSB-0802-U	SSB-0802-G	103"W X 24"H	SSB-0802-GDBL	103"W X 24"H
3'	SSB-0803	1	SSB-0803-U	SSB-0803-G	103"W X 36"H	SSB-0803-GDBL	103"W X 36"H
4'	SSB-0804	1	SSB-0804-U	SSB-0804-G	103"W X 48"H	SSB-0804-GDBL	103"W X 48"H
5'	SSB-0805	1	SSB-0805-U	SSB-0805-G	103"W X 60"H	SSB-0805-GDBL	103"W X 60"H
6'	SSB-0806	1	SSB-0806-U	SSB-0806-G	103"W X 72"H	SSB-0806-GDBL	103"W X 72"H

SSB-10' WIDTH							
HEIGHT	HARDWARE CODE	# OF BOXES OR CASES	UNPRINTED GRAPHIC CODE	SINGLE-SIDED GRAPHIC CODE	OUTER GRAPHIC SPECS	DOUBLE-SIDED GRAPHIC CODE	INSIDE GRAPHIC SPECS
2'	SSB-1002	1	SSB-1002-U	SSB-1002-G	128.7"W X 24"H	SSB-1002-GDBL	128.7"W X 24"H
3'	SSB-1003	1	SSB-1003-U	SSB-1003-G	128.7"W X 36"H	SSB-1003-GDBL	128.7"W X 36"H
4'	SSB-1004	1	SSB-1004-U	SSB-1004-G	128.7"W X 48"H	SSB-1004-GDBL	128.7"W X 48"H
5'	SSB-1005	1	SSB-1005-U	SSB-1005-G	128.7"W X 60"H	SSB-1005-GDBL	128.7"W X 60"H
6'	SSB-1006	1	SSB-1006-U	SSB-1006-G	128.7"W X 72"H	SSB-1006-GDBL	128.7"W X 72"H

SSB-12' WIDTH							
HEIGHT	HARDWARE CODE	# OF BOXES OR CASES	UNPRINTED GRAPHIC CODE	SINGLE-SIDED GRAPHIC CODE	OUTER GRAPHIC SPECS	DOUBLE-SIDED GRAPHIC CODE	INSIDE GRAPHIC SPECS
2'	SSB-1202	1	SSB-1202-U	SSB-1202-G	154.4"W X 24"H	SSB-1202-GDBL	154.4"W X 24"H
3'	SSB-1203	1	SSB-1203-U	SSB-1203-G	154.4"W X 36"H	SSB-1203-GDBL	154.4"W X 36"H
4'	SSB-1204	1	SSB-1204-U	SSB-1204-G	154.4"W X 48"H	SSB-1204-GDBL	154.4"W X 48"H
5'	SSB-1205	1	SSB-1205-U	SSB-1205-G	154.4"W X 60"H	SSB-1205-GDBL	154.4"W X 60"H
6'	SSB-1206	1	SSB-1206-U	SSB-1206-G	154.4"W X 72"H	SSB-1206-GDBL	154.4"W X 72"H

SSB-14' WIDTH							
HEIGHT	HARDWARE CODE	# OF BOXES OR CASES	UNPRINTED GRAPHIC CODE	SINGLE-SIDED GRAPHIC CODE	OUTER GRAPHIC SPECS	DOUBLE-SIDED GRAPHIC CODE	INSIDE GRAPHIC SPECS
2'	SSB-1402	1	SSB-1402-U	SSB-1402-G	180.2"W X 24"H	SSB-1402-GDBL	180.2"W X 24"H
3'	SSB-1403	1	SSB-1403-U	SSB-1403-G	180.2"W X 36"H	SSB-1403-GDBL	180.2"W X 36"H
4'	SSB-1404	1	SSB-1404-U	SSB-1404-G	180.2"W X 48"H	SSB-1404-GDBL	180.2"W X 48"H
5'	SSB-1405	1	SSB-1405-U	SSB-1405-G	180.2"W X 60"H	SSB-1405-GDBL	180.2"W X 60"H
6'	SSB-1406	1	SSB-1406-U	SSB-1406-G	180.2"W X 72"H	SSB-1406-GDBL	180.2"W X 72"H

SSB-16' WIDTH							
HEIGHT	HARDWARE CODE	# OF BOXES OR CASES	UNPRINTED GRAPHIC CODE	SINGLE-SIDED GRAPHIC CODE	OUTER GRAPHIC SPECS	DOUBLE-SIDED GRAPHIC CODE	INSIDE GRAPHIC SPECS
2'	SSB-1602	2	SSB-1602-U	SSB-1602-G	206"W X 24"H	SSB-1602-GDBL	206"W X 24"H
3'	SSB-1603	2	SSB-1603-U	SSB-1603-G	206"W X 36"H	SSB-1603-GDBL	206"W X 36"H
4'	SSB-1604	2	SSB-1604-U	SSB-1604-G	206"W X 48"H	SSB-1604-GDBL	206"W X 48"H
5'	SSB-1605	2	SSB-1605-U	SSB-1605-G	206"W X 60"H	SSB-1605-GDBL	206"W X 60"H
6'	SSB-1606	2	SSB-1606-U	SSB-1606-G	206"W X 72"H	SSB-1606-GDBL	206"W X 72"H

SSB-18' WIDTH							
HEIGHT	HARDWARE CODE	# OF BOXES OR CASES	UNPRINTED GRAPHIC CODE	SINGLE-SIDED GRAPHIC CODE	OUTER GRAPHIC SPECS	DOUBLE-SIDED GRAPHIC CODE	INSIDE GRAPHIC SPECS
2'	SSB-1802	2	SSB-1802-U	SSB-1802-G	231.6"W X 24"H	SSB-1802-GDBL	231.6"W X 24"H
3'	SSB-1803	2	SSB-1803-U	SSB-1803-G	231.6"W X 36"H	SSB-1803-GDBL	231.6"W X 36"H
4'	SSB-1804	2	SSB-1804-U	SSB-1804-G	231.6"W X 48"H	SSB-1804-GDBL	231.6"W X 48"H
5'	SSB-1805	2	SSB-1805-U	SSB-1805-G	231.6"W X 60"H	SSB-1805-GDBL	231.6"W X 60"H
6'	SSB-1806	2	SSB-1806-U	SSB-1806-G	231.6"W X 72"H	SSB-1806-GDBL	231.6"W X 72"H

SSB-20' WIDTH							
HEIGHT	HARDWARE CODE	# OF BOXES OR CASES	UNPRINTED GRAPHIC CODE	SINGLE-SIDED GRAPHIC CODE	OUTER GRAPHIC SPECS	DOUBLE-SIDED GRAPHIC CODE	INSIDE GRAPHIC SPECS
2'	SSB-2002	2	SSB-2002-U	SSB-2002-G	257.4"W X 24"H	SSB-2002-GDBL	257.4"W X 24"H
3'	SSB-2003	2	SSB-2003-U	SSB-2003-G	257.4"W X 36"H	SSB-2003-GDBL	257.4"W X 36"H
4'	SSB-2004	2	SSB-2004-U	SSB-2004-G	257.4"W X 48"H	SSB-2004-GDBL	257.4"W X 48"H
5'	SSB-2005	2	SSB-2005-U	SSB-2005-G	257.4"W X 60"H	SSB-2005-GDBL	257.4"W X 60"H
6'	SSB-2006	2	SSB-2006-U	SSB-2006-G	257.4"W X 72"H	SSB-2006-GDBL	257.4"W X 72"H

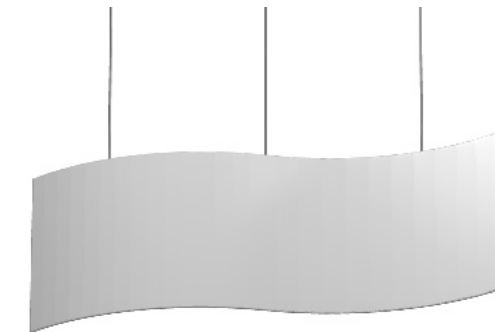

Unprinted graphic  
black & white options



Single sided & double sided graphic

**\*ALL GRAPHIC SIZES NOTED ARE FINISHED SIZES AND DO NOT INCLUDE REQUIRED BLEEDS. REFERENCE GRAPHIC TEMPLATES.**

# SSB-1806

**SET UP INSTRUCTIONS:**

1. CONNECT BOTTOM AND TOP TUBES FOLLOWING THE LABELS
2. CONNECT SIDE TUBES
3. CLEAN THE FRAME AND PLACE THEM ON CLEAN PLACE
4. CAREFULLY REMOVE FABRIC COVER FROM BAG
5. PLACE COVER AROUND THE BOTTOM OF THE FRAME
6. PULL COVER CAREFULLY UP TO THE TOP
7. CLOSE ALL ZIPPERS
8. ADJUST FABRIC AROUND THE FRAME
9. CONNECT CABLE HARNESS TO THE EYEBOLTS
10. COMPLETELY TIGHTEN THREADED CONNECTORS

**BREAK DOWN INSTRUCTIONS:**  
REVERSE SET-UP STEPS TO BREAKDOWN FRAME

- FABRIC CARE INSTRUCTIONS:**
1. UNZIP COVER ZIPPERS
  2. CAREFULLY REMOVE FABRIC COVER
  3. CLOSE ALL ZIPPERS
  4. FOLD OR ROLL NEATLY
  5. PLACE FABRIC IN COVER BAG

**FRAME ASSEMBLY**

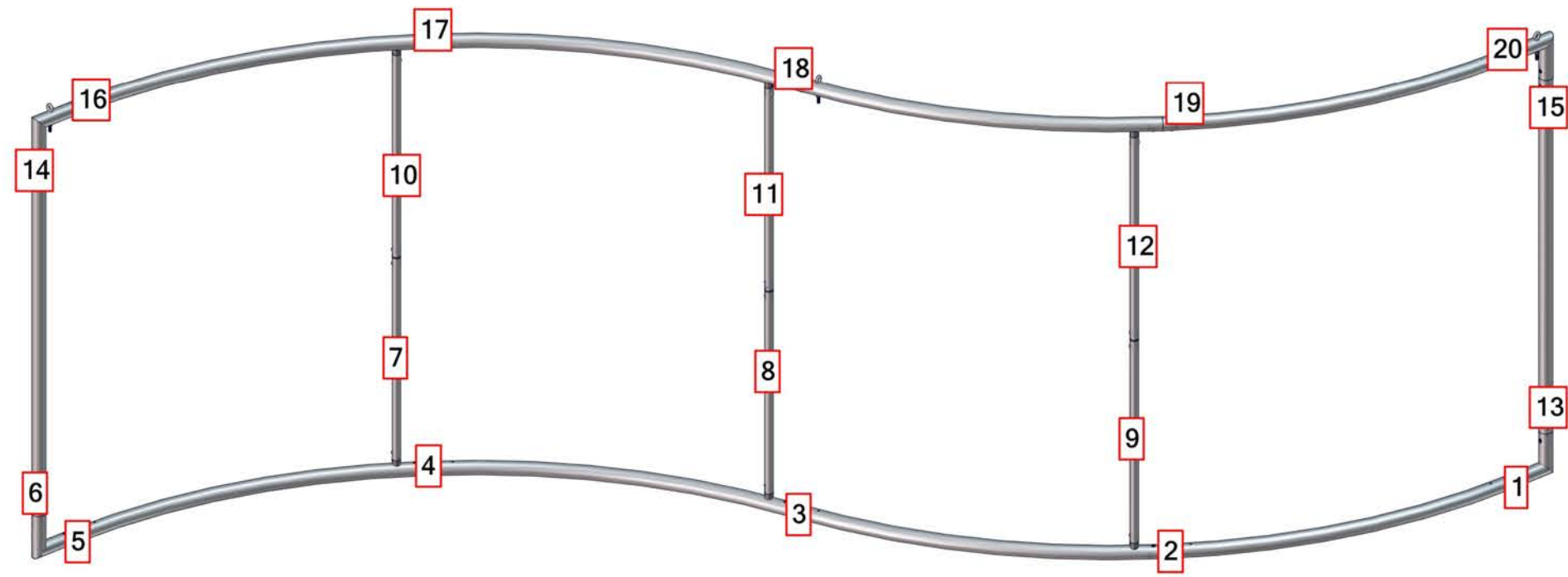

TOTAL WEIGHT: 72.8 (lbs)  
MAX SIZE: 58.0 (in)  
HARDWARE: 44.0 (lbs)  
GRAPHIC: 24.5 (lbs)

QTY	CODE	DESCRIPTION
3	HD-06	72" LENGTH 1/8" 7X7 GALVANIZED STEEL CABLE NATURAL VINYL COATED TO 3/16" OD
3	EYE BOLT	5/16-18X3.125" PARTIALLY THREADED EYE BOLT FOR 2" TUBING FABRIC STRUCTURES
2	SPDR-50-S2-6	2" TUBING SPREADER FOR 6' HIGH FOR FOUR SIDED HANGING FABRIC STRUCTURES
8	SSB-18-T1	TUBE 1 FOR 18' S-CURVE HANGING FABRIC STRUCTURES
4	CORNER-50-90°-2WAY	2IN TUBE 90° WELDED 2-WAY CORNER
6	SPDR-30-S2-6	30MM STRAIGHT SPREADER FOR 50MM CONNECTIONS OF 6' STRUCTURES
3	TC-30-S	INLINE CONNECTOR FOR 30MM TUBING

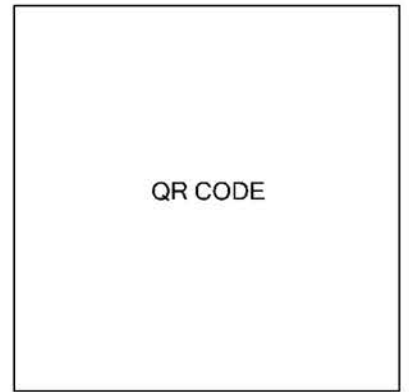
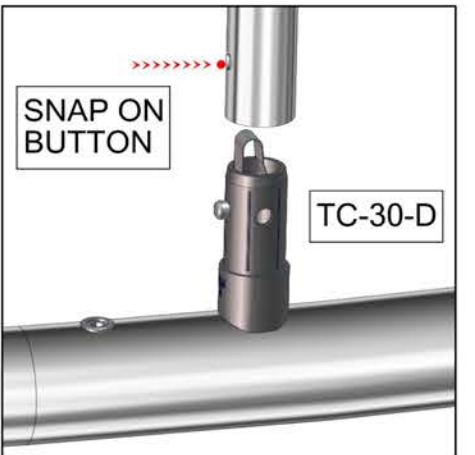
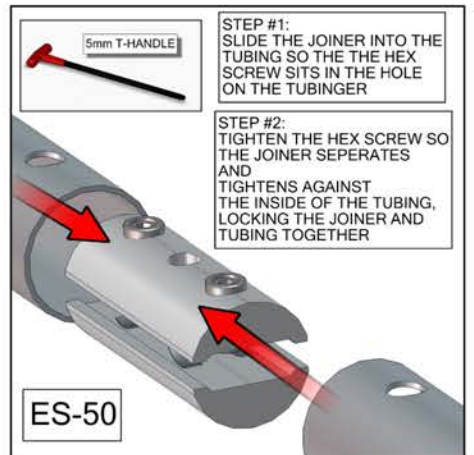
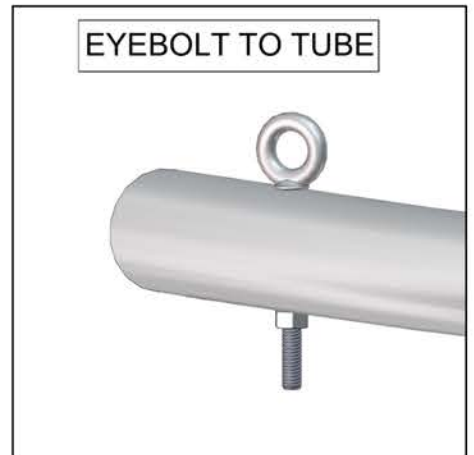
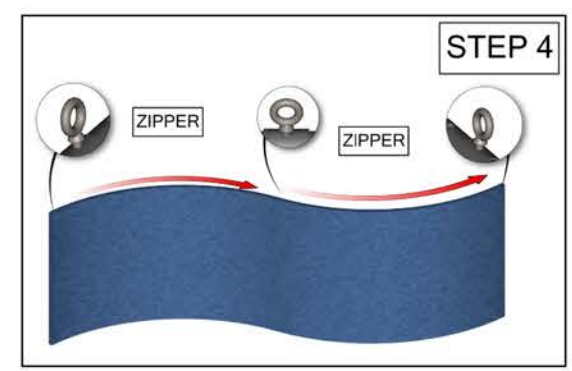
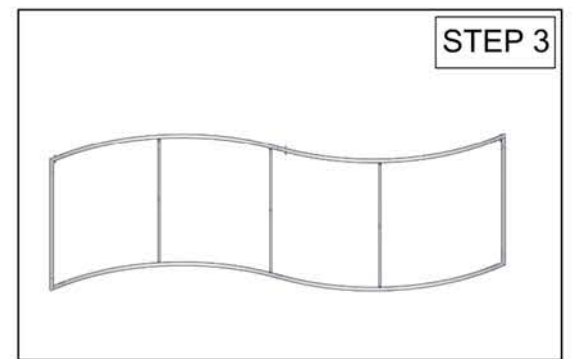
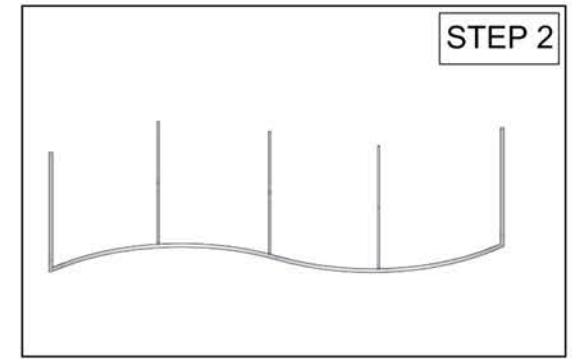
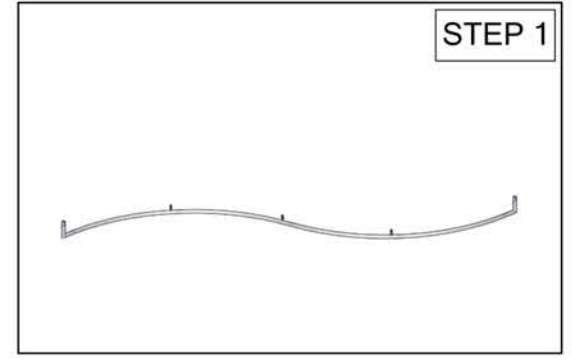

Set-up Video