

Square Hanging Structures

SQU

Square tension fabric hanging structures are made in the USA and are of the utmost quality and durability. State-of-the-art zipper pillowcase dye-sublimated stretch fabric coverings are combined with advanced, lightweight aluminum structures to provide unique design, functionality, and style. Hanging structures are offered in a wide variety of shapes and sizes. Stretch fabric graphics are hand-sewn, durable and dry-cleanable.

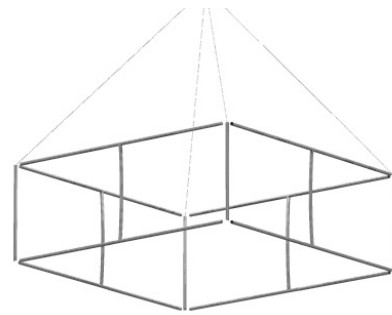

Frame



Single sided graphic



Double sided graphic

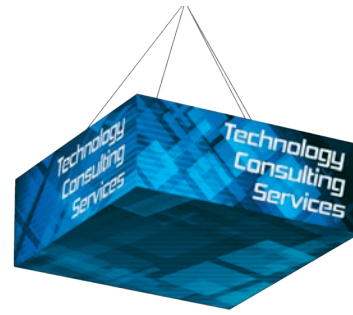

Graphic with printed bottom

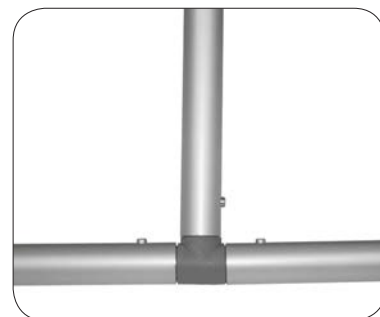

30mm tube push-button connector



50mm tube spigot connector

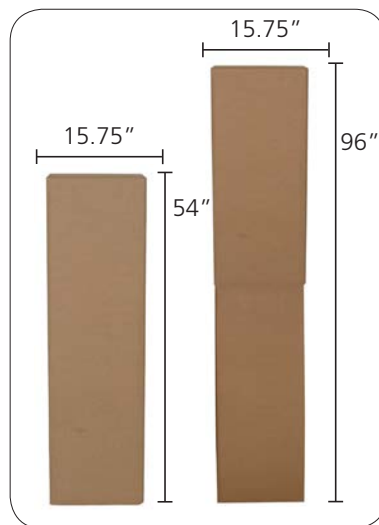

Hanging Structure standard box



OCE Expandable Display Case - Available as an upgrade

features and benefits:

- Square hanging structures come in 8', 10', 12', 14', 16', 18' & 20' width configurations at varying heights of 2', 3', 4', 5' & 6'
- Shapes 12' width and under are constructed with 30mm (1^{1/8}") tubes and push-button connectors for simple assembly
- Shapes 14' width and over are constructed with 50mm (2") tubes and internal expanding spigot connectors for unmatched structural integrity
- Engineer certified (structural engineer certificate available upon request)
- Zippered pillowcase fabric graphic options include: unprinted (white and black), single-sided (outer panel printed only), double-sided (inner and outer panels printed), and zip-in unprinted (white and black) and printed bottom panels
- All pillowcase graphics come standard with opaque liner
- Both bottom zip-in graphic panels offered on 8', 10', 12', and 14' width options only
- Comes standard with hanging hardware, bags and heavy-duty shipping and storage box(es)
- OCE Expandable rugged molded shipping cases available as an upgrade
- Collapses to a fraction of its size
- Easy to store and ship
- Quick to set up

dimensions:

Hardware can be found on page 2

Graphic dimensions can be found in the graphic templates, which can be viewed at www.exhibitors-handbook.com/graphic-templates

Graphic Material:

5 oz. Soft Knit Dye-sublimated zipper pillowcase fabric

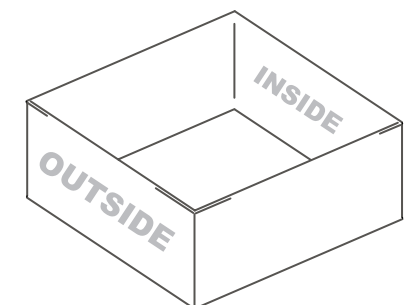
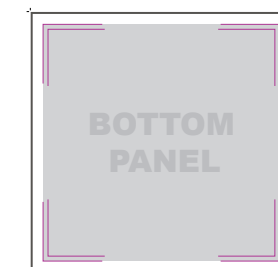
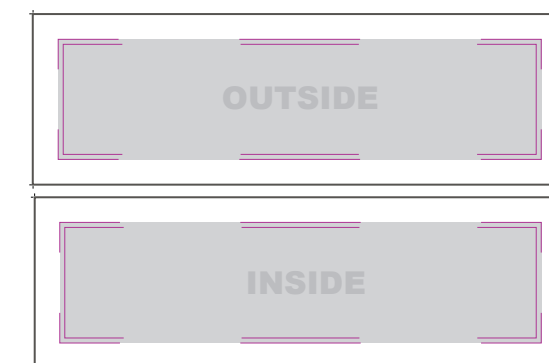

We are continually improving and modifying our product range and reserve the right to vary the specifications without prior notice. All dimensions and weights quoted are approximate and we accept no responsibility for variance. E&OE. See Graphic Templates for graphic bleed specifications.

SQU-8' WIDTH										
HEIGHT	HARDWARE CODE	# OF BOXES OR CASES	UNPRINTED GRAPHIC CODE	SINGLE-SIDED GRAPHIC CODE	OUTER GRAPHIC SPECS	DOUBLE-SIDED GRAPHIC CODE	INSIDE GRAPHIC SPECS	BOTTOM ZIP-IN PANEL (UNPRINTED) CODE	BOTTOM ZIP-IN PANEL (PRINTED) CODE	BOTTOM PANEL GRAPHIC SPECS
2'	SQU-0802	1	SQU-0802-U	SQU-0802-G	96"W X 24"H	SQU-0802-GDBL	96"W X 24"H	SQU-0802-GUBP	SQU-0802-GPBP	96"W X 96"H
3'	SQU-0803	1	SQU-0803-U	SQU-0803-G	96"W X 36"H	SQU-0803-GDBL	96"W X 36"H	SQU-0803-GUBP	SQU-0803-GPBP	96"W X 96"H
4'	SQU-0804	1	SQU-0804-U	SQU-0804-G	96"W X 48"H	SQU-0804-GDBL	96"W X 48"H	SQU-0804-GUBP	SQU-0804-GPBP	96"W X 96"H
5'	SQU-0805	1	SQU-0805-U	SQU-0805-G	96"W X 60"H	SQU-0805-GDBL	96"W X 60"H	SQU-0805-GUBP	SQU-0805-GPBP	96"W X 96"H
6'	SQU-0806	1	SQU-0806-U	SQU-0806-G	96"W X 72"H	SQU-0806-GDBL	96"W X 72"H	SQU-0806-GUBP	SQU-0806-GPBP	96"W X 96"H

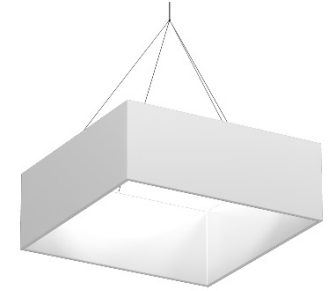

Unprinted graphic
black & white options

SQU-10' WIDTH										
HEIGHT	HARDWARE CODE	# OF BOXES OR CASES	UNPRINTED GRAPHIC CODE	SINGLE-SIDED GRAPHIC CODE	OUTER GRAPHIC SPECS	DOUBLE-SIDED GRAPHIC CODE	INSIDE GRAPHIC SPECS	BOTTOM ZIP-IN PANEL (UNPRINTED) CODE	BOTTOM ZIP-IN PANEL (PRINTED) CODE	BOTTOM PANEL GRAPHIC SPECS
2'	SQU-1002	1	SQU-1002-U	SQU-1002-G	120"W X 24"H	SQU-1002-GDBL	120"W X 24"H	SQU-1002-GUBP	SQU-1002-GPBP	120"W X 120"H
3'	SQU-1003	1	SQU-1003-U	SQU-1003-G	120"W X 36"H	SQU-1003-GDBL	120"W X 36"H	SQU-1003-GUBP	SQU-1003-GPBP	120"W X 120"H
4'	SQU-1004	1	SQU-1004-U	SQU-1004-G	120"W X 48"H	SQU-1004-GDBL	120"W X 48"H	SQU-1004-GUBP	SQU-1004-GPBP	120"W X 120"H
5'	SQU-1005	1	SQU-1005-U	SQU-1005-G	120"W X 60"H	SQU-1005-GDBL	120"W X 60"H	SQU-1005-GUBP	SQU-1005-GPBP	120"W X 120"H
6'	SQU-1006	1	SQU-1006-U	SQU-1006-G	120"W X 72"H	SQU-1006-GDBL	120"W X 72"H	SQU-1006-GUBP	SQU-1006-GPBP	120"W X 120"H



Single sided graphic

SQU-12' WIDTH										
HEIGHT	HARDWARE CODE	# OF BOXES OR CASES	UNPRINTED GRAPHIC CODE	SINGLE-SIDED GRAPHIC CODE	OUTER GRAPHIC SPECS	DOUBLE-SIDED GRAPHIC CODE	INSIDE GRAPHIC SPECS	BOTTOM ZIP-IN PANEL (UNPRINTED) CODE	BOTTOM ZIP-IN PANEL (PRINTED) CODE	BOTTOM PANEL GRAPHIC SPECS
2'	SQU-1202	1	SQU-1202-U	SQU-1202-G	144"W X 24"H	SQU-1202-GDBL	144"W X 24"H	SQU-1202-GUBP	SQU-1202-GPBP	144"W X 144"H
3'	SQU-1203	1	SQU-1203-U	SQU-1203-G	144"W X 36"H	SQU-1203-GDBL	144"W X 36"H	SQU-1203-GUBP	SQU-1203-GPBP	144"W X 144"H
4'	SQU-1204	1	SQU-1204-U	SQU-1204-G	144"W X 48"H	SQU-1204-GDBL	144"W X 48"H	SQU-1204-GUBP	SQU-1204-GPBP	144"W X 144"H
5'	SQU-1205	1	SQU-1205-U	SQU-1205-G	144"W X 60"H	SQU-1205-GDBL	144"W X 60"H	SQU-1205-GUBP	SQU-1205-GPBP	144"W X 144"H
6'	SQU-1206	1	SQU-1206-U	SQU-1206-G	144"W X 72"H	SQU-1206-GDBL	144"W X 72"H	SQU-1206-GUBP	SQU-1206-GPBP	144"W X 144"H



Double sided graphic

SQU-14' WIDTH										
HEIGHT	HARDWARE CODE	# OF BOXES OR CASES	UNPRINTED GRAPHIC CODE	SINGLE-SIDED GRAPHIC CODE	OUTER GRAPHIC SPECS	DOUBLE-SIDED GRAPHIC CODE	INSIDE GRAPHIC SPECS	BOTTOM ZIP-IN PANEL (UNPRINTED) CODE	BOTTOM ZIP-IN PANEL (PRINTED) CODE	BOTTOM PANEL GRAPHIC SPECS
2'	SQU-1402	2	SQU-1402-U	SQU-1402-G	168"W X 24"H	SQU-1402-GDBL	168"W X 24"H	SQU-1402-GUBP	SQU-1402-GPBP	168"W X 168"H
3'	SQU-1403	2	SQU-1403-U	SQU-1403-G	168"W X 36"H	SQU-1403-GDBL	168"W X 36"H	SQU-1403-GUBP	SQU-1403-GPBP	168"W X 168"H
4'	SQU-1404	2	SQU-1404-U	SQU-1404-G	168"W X 48"H	SQU-1404-GDBL	168"W X 48"H	SQU-1404-GUBP	SQU-1404-GPBP	168"W X 168"H
5'	SQU-1405	2	SQU-1405-U	SQU-1405-G	168"W X 60"H	SQU-1405-GDBL	168"W X 60"H	SQU-1405-GUBP	SQU-1405-GPBP	168"W X 168"H
6'	SQU-1406	2	SQU-1406-U	SQU-1406-G	168"W X 72"H	SQU-1406-GDBL	168"W X 72"H	SQU-1406-GUBP	SQU-1406-GPBP	168"W X 168"H

SQU-16' WIDTH							
HEIGHT	HARDWARE CODE	# OF BOXES OR CASES	UNPRINTED GRAPHIC CODE	SINGLE-SIDED GRAPHIC CODE	OUTER GRAPHIC SPECS	DOUBLE-SIDED GRAPHIC CODE	INSIDE GRAPHIC SPECS
2'	SQU-1602	2	SQU-1602-U	SQU-1602-G	192"W X 24"H	SQU-1602-GDBL	192"W X 24"H
3'	SQU-1603	2	SQU-1603-U	SQU-1603-G	192"W X 36"H	SQU-1603-GDBL	192"W X 36"H
4'	SQU-1604	2	SQU-1604-U	SQU-1604-G	192"W X 48"H	SQU-1604-GDBL	192"W X 48"H
5'	SQU-1605	2	SQU-1605-U	SQU-1605-G	192"W X 60"H	SQU-1605-GDBL	192"W X 60"H
6'	SQU-1606	2	SQU-1606-U	SQU-1606-G	192"W X 72"H	SQU-1606-GDBL	192"W X 72"H

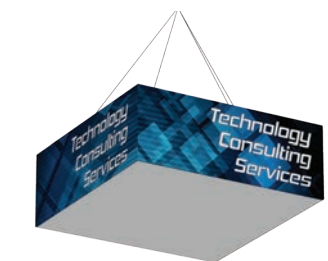

Unprinted zip-in bottom panel
black & white options

SQU-18' WIDTH							
HEIGHT	HARDWARE CODE	# OF BOXES OR CASES	UNPRINTED GRAPHIC CODE	SINGLE-SIDED GRAPHIC CODE	OUTER GRAPHIC SPECS	DOUBLE-SIDED GRAPHIC CODE	INSIDE GRAPHIC SPECS
2'	SQU-1802	2	SQU-1802-U	SQU-1802-G	216"W X 24"H	SQU-1802-GDBL	216"W X 24"H
3'	SQU-1803	2	SQU-1803-U	SQU-1803-G	216"W X 36"H	SQU-1803-GDBL	216"W X 36"H
4'	SQU-1804	2	SQU-1804-U	SQU-1804-G	216"W X 48"H	SQU-1804-GDBL	216"W X 48"H
5'	SQU-1805	2	SQU-1805-U	SQU-1805-G	216"W X 60"H	SQU-1805-GDBL	216"W X 60"H
6'	SQU-1806	2	SQU-1806-U	SQU-1806-G	216"W X 72"H	SQU-1806-GDBL	216"W X 72"H

SQU-20' WIDTH							
HEIGHT	HARDWARE CODE	# OF BOXES OR CASES	UNPRINTED GRAPHIC CODE	SINGLE-SIDED GRAPHIC CODE	OUTER GRAPHIC SPECS	DOUBLE-SIDED GRAPHIC CODE	INSIDE GRAPHIC SPECS
2'	SQU-2002	2	SQU-2002-U	SQU-2002-G	240"W X 24"H	SQU-2002-GDBL	240"W X 24"H
3'	SQU-2003	2	SQU-2003-U	SQU-2003-G	240"W X 36"H	SQU-2003-GDBL	240"W X 36"H
4'	SQU-2004	2	SQU-2004-U	SQU-2004-G	240"W X 48"H	SQU-2004-GDBL	240"W X 48"H
5'	SQU-2005	2	SQU-2005-U	SQU-2005-G	240"W X 60"H	SQU-2005-GDBL	240"W X 60"H
6'	SQU-2006	2	SQU-2006-U	SQU-2006-G	240"W X 72"H	SQU-2006-GDBL	240"W X 72"H

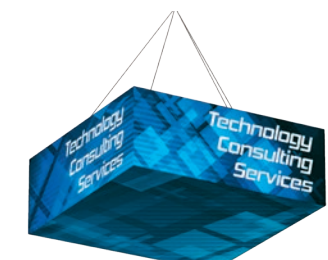

Printed zip-in bottom panel

*ALL GRAPHIC SIZES NOTED ARE FINISHED SIZES AND DO NOT INCLUDE REQUIRED BLEEDS. REFERENCE GRAPHIC TEMPLATES.

SQU-0802

SET UP INSTRUCTIONS:

1. CONNECT BOTTOM AND TOP TUBES FOLLOWING THE LABELS
2. CONNECT SIDE TUBES
3. CLEAN THE FRAME AND PLACE THEM ON CLEAN PLACE
4. CAREFULLY REMOVE FABRIC COVER FROM BAG
5. PLACE COVER AROUND THE BOTTOM OF THE FRAME
6. PULL COVER CAREFULLY UP TO THE TOP
7. CLOSE ALL ZIPPERS
8. ADJUST FABRIC AROUND THE FRAME
9. CONNECT CABLE HARNESS TO THE EYEBOLTS
10. COMPLETELY TIGHTEN THREADED CONNECTORS

BREAK DOWN INSTRUCTIONS:

REVERSE SET-UP STEPS TO BREAKDOWN FRAME

FABRIC CARE INSTRUCTIONS:

1. UNZIP COVER ZIPPERS
2. CAREFULLY REMOVE FABRIC COVER
3. CLOSE ALL ZIPPERS
4. FOLD OR ROLL NEATLY
5. PLACE FABRIC IN COVER BAG

TOTAL WEIGHT: 32.7(lbs)
 MAX SIZE: 44.3(in)
 HARDWARE: 21.7(lbs)
 GRAPHIC: 8.9(lbs)

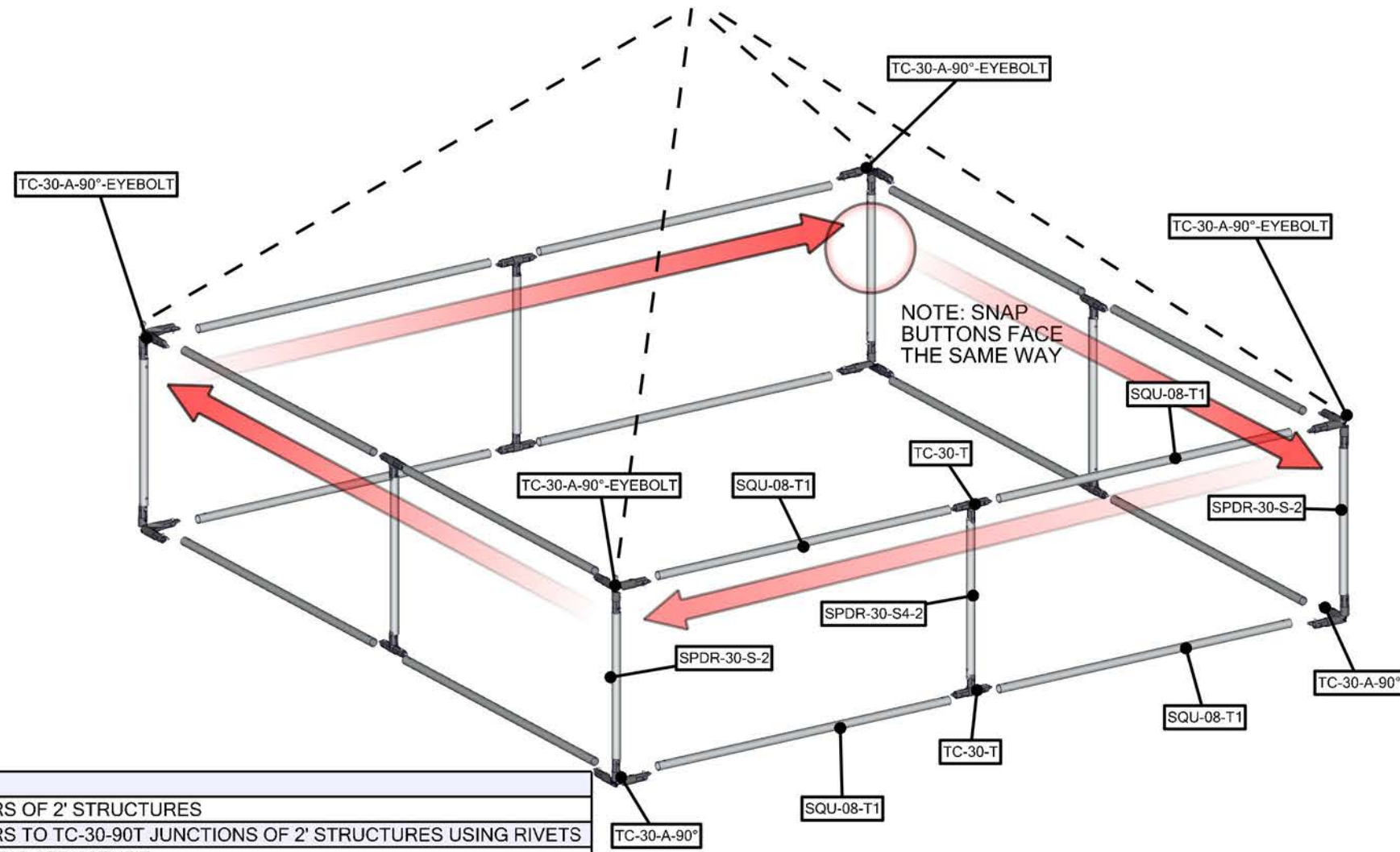

STEP 1

STEP 2

STEP 3

STEP 4

QTY	CODE	DESCRIPTION
4	SPDR-30-S-2	30MM STRAIGHT SPREADER FOR CORNERS OF 2' STRUCTURES
4	SPDR-30-S4-2	30MM STRAIGHT SPREADER FOR CORNERS TO TC-30-90T JUNCTIONS OF 2' STRUCTURES USING RIVETS
16	SQU-08-T1	TUBE 1 FOR 8' FOUR SIDED HANGING FABRIC STRUCTURE
4	TC-30-A-90°	TC-30-A ASSEMBLED at 90°
4	TC-30-A-90°-EYEBOLT	TC-30-A ASSEMBLED at 90° WITH 1/4-20 EYE BOLT
8	TC-30-T	T JUNCTION FOR 30MM TUBING

