

Formulate 10' Shield Tower - 02

SHD-TOWER-02

When you are looking for a way to draw attention and captivate your audience at a tradeshow, special event, or in a permanent environment, these Formulate® tension fabric architectural structures are designed to impress. Mix and match the Formulate line of towers to add architecture and drama to any event or interior space.

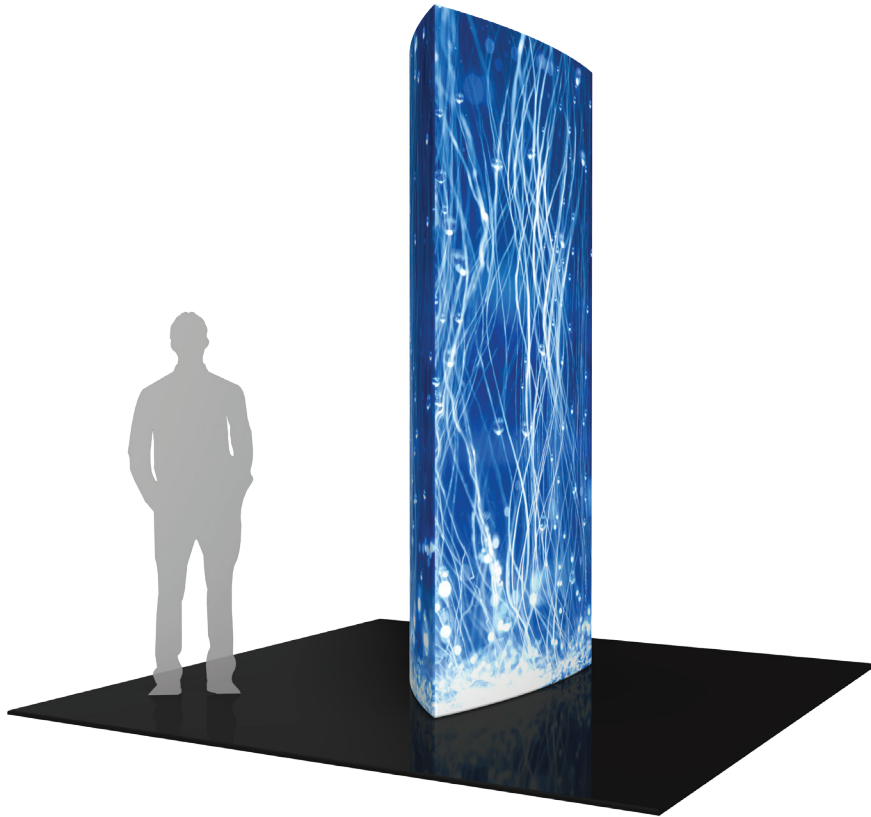

features and benefits:

- Premium aluminum tube frames with snap button assembly
- Easy to store and ship
- Quick to set up
- One zipper pillowcase fabric graphic
- Lifetime limited hardware warranty against manufacturer defects

dimensions:

Hardware

Assembled unit:
36" w x 120" h x 59.5" d
915mm(w) x 3048mm(h) x 1512mm(d)

Approximate weight:
68 lbs / 31kgs

Graphic

Refer to related graphic template for more information.

Visit:
www.exhibitors-handbook.com/graphic-templates

Shipping

Packing case(s):
1 OCE-2

Shipping dimensions:
OCE-2: Expandable case length (l) may vary
40" - 66" l x 18" h x 18" d
1016mm-1677mm(l) x 458mm(h) x 458mm(d)

Approximate total shipping weight:
95 lbs / 43 kgs

additional information:

Graphic material:
Dye-sublimation zipper pillowcase fabric

When included in a larger kit, a different packaging solution will be listed to accommodate all contents of the kit. Individual packaging no longer provided.

1 person assembly recommended:



We are continually improving and modifying our product range and reserve the right to vary the specifications without prior notice. All dimensions and weights quoted are approximate and we accept no responsibility for variance. E&OE. See Graphic Templates for graphic bleed specifications.

Included In Your Kit

Tools, Components, & Connectors



TC-30-A x6

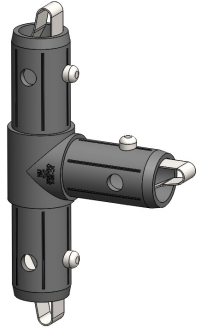

TC-30-T x1



SHD-TOWER-01-T1 x4

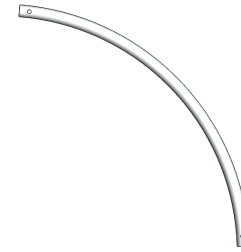

SHD-TOWER-01-T2 x2

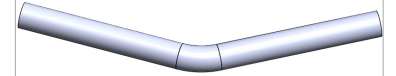

SHD-TOWER-01-T3 x2



SHD-TOWER-01-T4 x1



SHD-TOWER-02-T5 x3

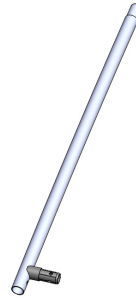

SHD-TOWER-02-T6 x1

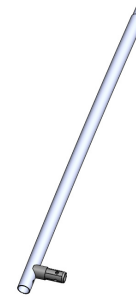

SHD-TOWER-02-T7 x1

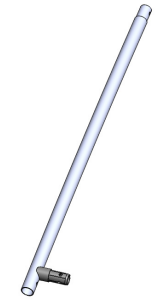

SHD-TOWER-02-T8 x1

Graphics



SHD-TOWER-02-G x1

Exploded View

SHD-TOWER-02

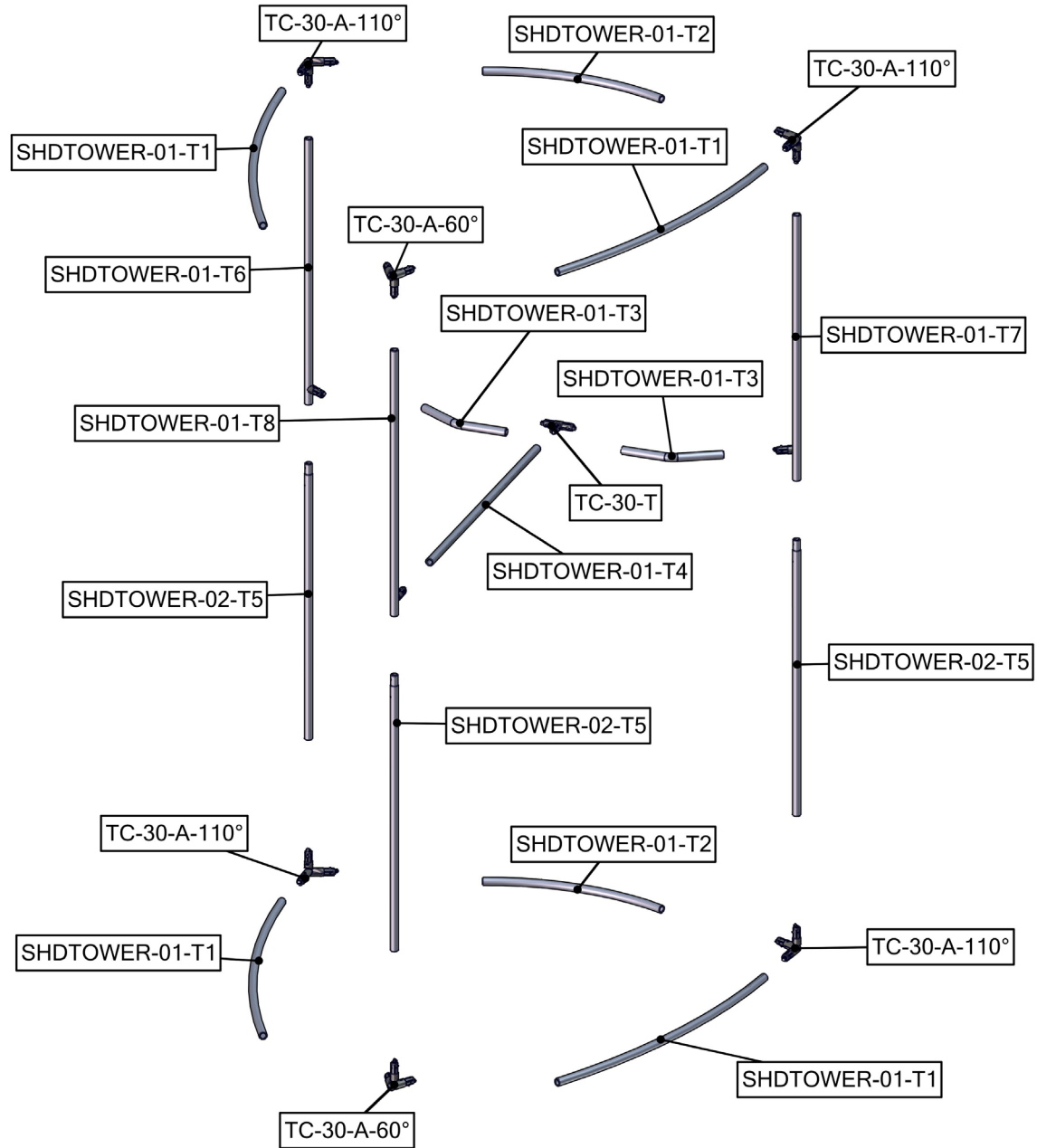

Labeling Diagram

SHD-TOWER-02

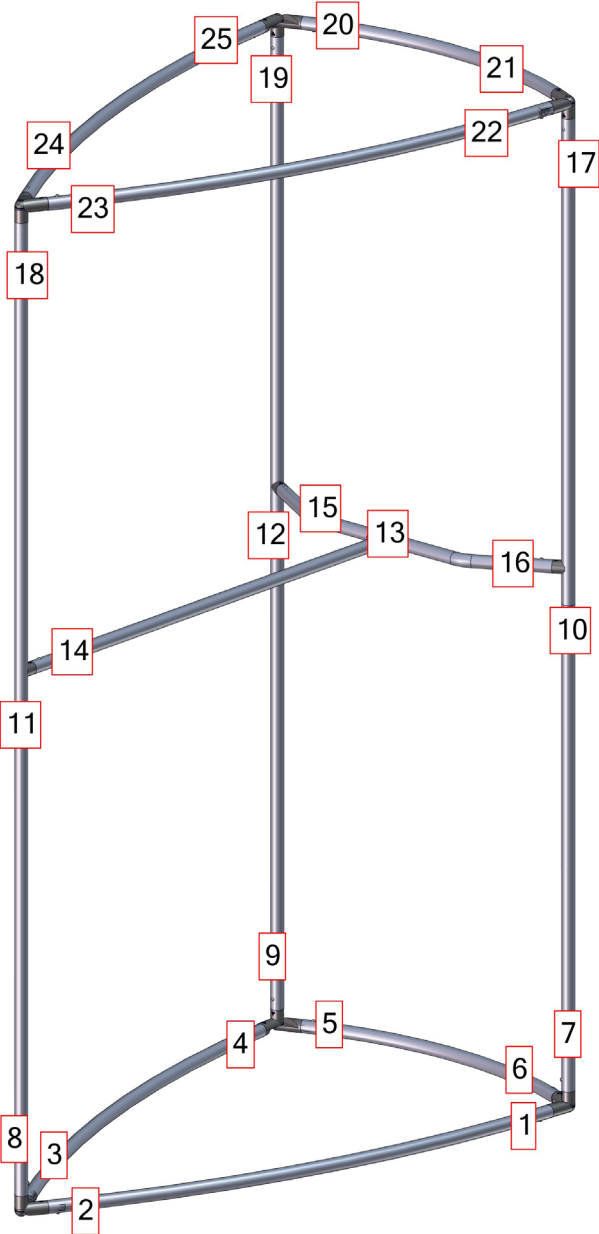

Connection Methods

Connection Method 1: ES30 / ES50 / ES75

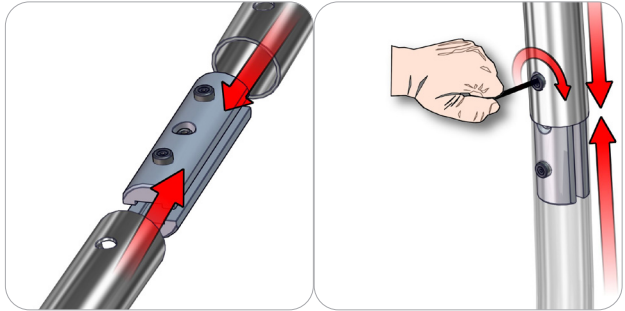

Compress the unlocked connector and slide one tube onto each end. Lock both screws carefully using your allen key tool. Be sure to lock securely, but do not over tighten.

Connection Method 2: Snap Buttons & Swage

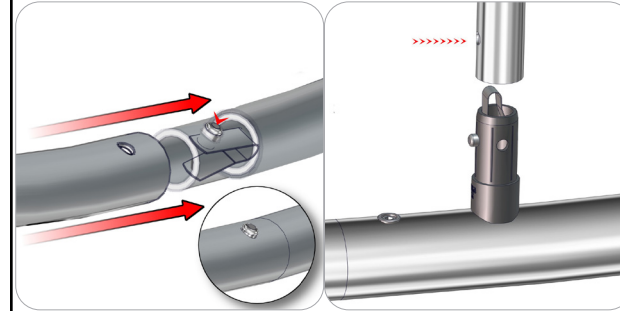

Locate the snap button on the connector or swage tube. Locate the hole on the corresponding tube. Press the snap button with your thumb and slide the tube and connector together so that the snap button snaps fully into the lock hole. To disassemble, press the snap button and pull apart.

Kit Assembly

Step by Step

Step 1.

Gather the components to build the frame with the narrow side laid out on the floor. Use the Exploded View and Labeling Diagram for component position. Reference Connection Method 2 for more details.

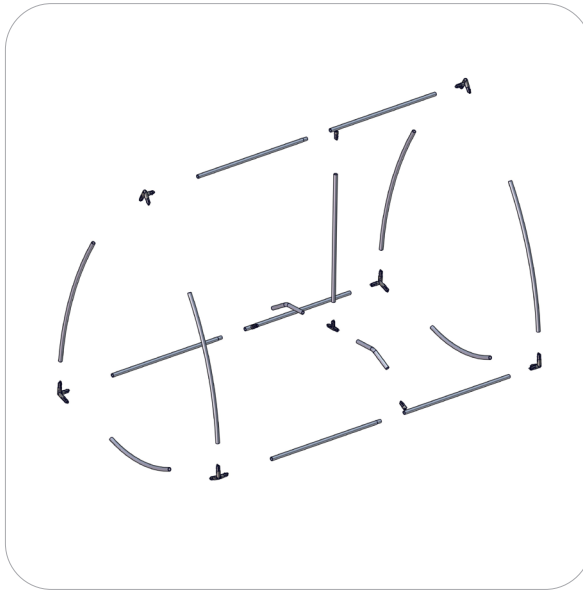
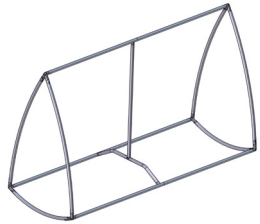

Step 2.

With the frame assembled on the floor, open the zipper pillowcase and pull it over the frame. Close the zipper at the base of the frame then stand the unit upright.

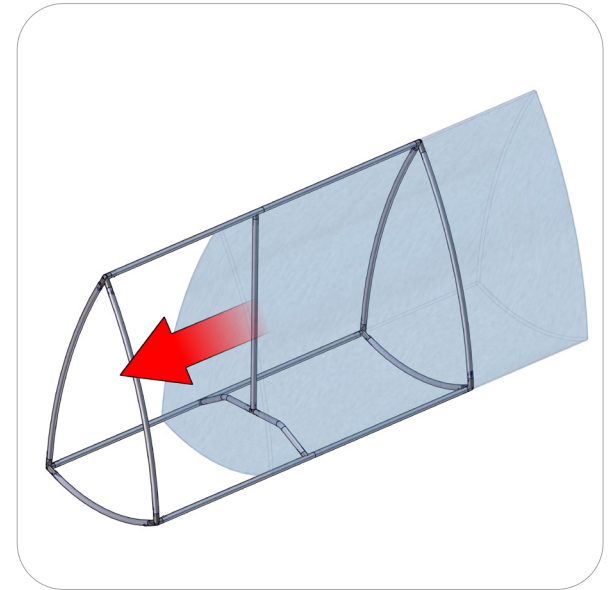
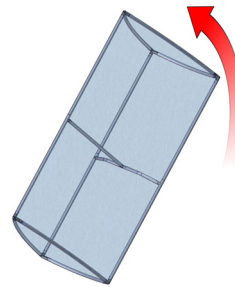

Step 3.

Setup is complete.

