

Convex Three Sided Hanging Structures

SHD

Convex Three Sided tension fabric hanging structures are made in the USA and are of the utmost quality and durability. State-of-the-art zipper pillowcase dye-sublimated stretch fabric coverings are combined with advanced, lightweight aluminum structures to provide unique design, functionality, and style. Hanging structures are offered in a wide variety of shapes and sizes. Stretch fabric graphics are hand-sewn, durable and dry-cleanable.

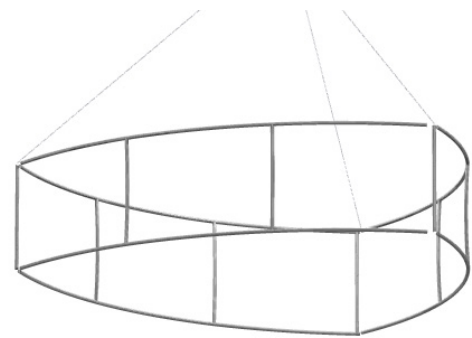

Frame



Single sided graphic



Double sided graphic

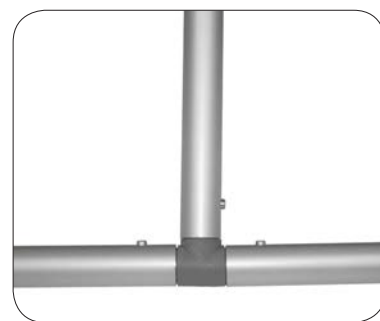

30mm tube push-button connector



50mm tube spigot connector



Hanging Structure standard box

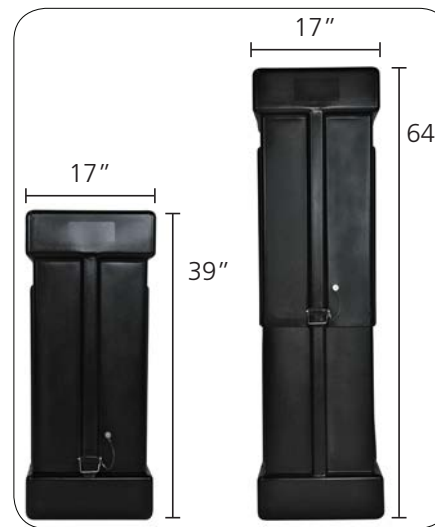

OCE Expandable Display Case - Available as an upgrade

features and benefits:

- Convex three sided hanging structures come in 8', 10', 12', 14', 16', 18' & 20' width configurations at varying heights of 2', 3', 4', 5' & 6'
- Shapes 12' width and under are constructed with 30mm (1^{1/8}") tubes and push-button connectors for simple assembly
- Shapes 14' width and over are constructed with 50mm (2") tubes and internal expanding spigot connectors for unmatched structural integrity
- Engineer certified (structural engineer certificate available upon request)
- Zippered pillowcase fabric graphic options include: unprinted (white and black), single-sided (outer panel printed only) and double-sided (inner and outer panels printed)
- All pillowcase graphics come standard with opaque liner
- Comes standard with hanging hardware, bags and heavy-duty shipping and storage box(es)
- OCE Expandable rugged molded shipping cases available as an upgrade
- Collapses to a fraction of its size
- Easy to store and ship
- Quick to set up

dimensions:

Hardware can be found on page 2

Graphic dimensions can be found in the graphic templates, which can be viewed at www.exhibitors-handbook.com/graphic-templates

Graphic Material:

5 oz. Soft Knit Dye-sublimated zipper pillowcase fabric

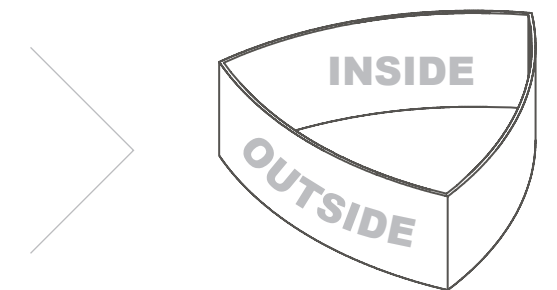
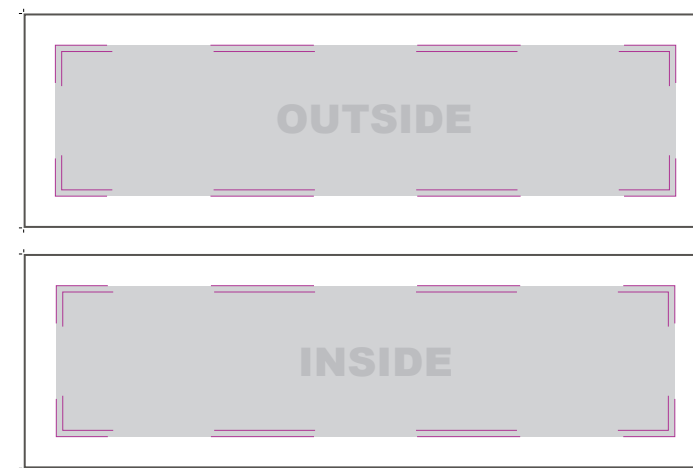

We are continually improving and modifying our product range and reserve the right to vary the specifications without prior notice. All dimensions and weights quoted are approximate and we accept no responsibility for variance. E&OE. See Graphic Templates for graphic bleed specifications.

SHD-8' WIDTH							
HEIGHT	HARDWARE CODE	# OF BOXES OR CASES	UNPRINTED GRAPHIC CODE	SINGLE-SIDED GRAPHIC CODE	OUTER GRAPHIC SPECS	DOUBLE-SIDED GRAPHIC CODE	INSIDE GRAPHIC SPECS
2'	SHD-0802	1	SHD-0802-U	SHD-0802-G	98.5"W X 24"H	SHD-0802-GDBL	95.8"W X 24"H
3'	SHD-0803	1	SHD-0803-U	SHD-0803-G	98.5"W X 36"H	SHD-0803-GDBL	95.8"W X 36"H
4'	SHD-0804	1	SHD-0804-U	SHD-0804-G	98.5"W X 48"H	SHD-0804-GDBL	95.8"W X 48"H
5'	SHD-0805	1	SHD-0805-U	SHD-0805-G	98.5"W X 60"H	SHD-0805-GDBL	95.8"W X 60"H
6'	SHD-0806	1	SHD-0806-U	SHD-0806-G	98.5"W X 72"H	SHD-0806-GDBL	95.8"W X 72"H

SHD-10' WIDTH							
HEIGHT	HARDWARE CODE	# OF BOXES OR CASES	UNPRINTED GRAPHIC CODE	SINGLE-SIDED GRAPHIC CODE	OUTER GRAPHIC SPECS	DOUBLE-SIDED GRAPHIC CODE	INSIDE GRAPHIC SPECS
2'	SHD-1002	1	SHD-1002-U	SHD-1002-G	123.2"W X 24"H	SHD-1002-GDBL	120.5"W X 24"H
3'	SHD-1003	1	SHD-1003-U	SHD-1003-G	123.2"W X 36"H	SHD-1003-GDBL	120.5"W X 36"H
4'	SHD-1004	1	SHD-1004-U	SHD-1004-G	123.2"W X 48"H	SHD-1004-GDBL	120.5"W X 48"H
5'	SHD-1005	1	SHD-1005-U	SHD-1005-G	123.2"W X 60"H	SHD-1005-GDBL	120.5"W X 60"H
6'	SHD-1006	1	SHD-1006-U	SHD-1006-G	123.2"W X 72"H	SHD-1006-GDBL	120.5"W X 72"H

SHD-12' WIDTH							
HEIGHT	HARDWARE CODE	# OF BOXES OR CASES	UNPRINTED GRAPHIC CODE	SINGLE-SIDED GRAPHIC CODE	OUTER GRAPHIC SPECS	DOUBLE-SIDED GRAPHIC CODE	INSIDE GRAPHIC SPECS
2'	SHD-1202	1	SHD-1202-U	SHD-1202-G	147.8"W X 24"H	SHD-1202-GDBL	145.1"W X 24"H
3'	SHD-1203	1	SHD-1203-U	SHD-1203-G	147.8"W X 36"H	SHD-1203-GDBL	145.1"W X 36"H
4'	SHD-1204	1	SHD-1204-U	SHD-1204-G	147.8"W X 48"H	SHD-1204-GDBL	145.1"W X 48"H
5'	SHD-1205	1	SHD-1205-U	SHD-1205-G	147.8"W X 60"H	SHD-1205-GDBL	145.1"W X 60"H
6'	SHD-1206	1	SHD-1206-U	SHD-1206-G	147.8"W X 72"H	SHD-1206-GDBL	145.1"W X 72"H

SHD-14' WIDTH							
HEIGHT	HARDWARE CODE	# OF BOXES OR CASES	UNPRINTED GRAPHIC CODE	SINGLE-SIDED GRAPHIC CODE	OUTER GRAPHIC SPECS	DOUBLE-SIDED GRAPHIC CODE	INSIDE GRAPHIC SPECS
2'	SHD-1402	2	SHD-1402-U	SHD-1402-G	172.4"W X 24"H	SHD-1402-GDBL	167.9"W X 24"H
3'	SHD-1403	2	SHD-1403-U	SHD-1403-G	172.4"W X 36"H	SHD-1403-GDBL	167.9"W X 36"H
4'	SHD-1404	2	SHD-1404-U	SHD-1404-G	172.4"W X 48"H	SHD-1404-GDBL	167.9"W X 48"H
5'	SHD-1405	2	SHD-1405-U	SHD-1405-G	172.4"W X 60"H	SHD-1405-GDBL	167.9"W X 60"H
6'	SHD-1406	2	SHD-1406-U	SHD-1406-G	172.4"W X 72"H	SHD-1406-GDBL	167.9"W X 72"H

SHD-16' WIDTH							
HEIGHT	HARDWARE CODE	# OF BOXES OR CASES	UNPRINTED GRAPHIC CODE	SINGLE-SIDED GRAPHIC CODE	OUTER GRAPHIC SPECS	DOUBLE-SIDED GRAPHIC CODE	INSIDE GRAPHIC SPECS
2'	SHD-1602	2	SHD-1602-U	SHD-1602-G	197.1"W X 24"H	SHD-1602-GDBL	192.6"W X 24"H
3'	SHD-1603	2	SHD-1603-U	SHD-1603-G	197.1"W X 36"H	SHD-1603-GDBL	192.6"W X 36"H
4'	SHD-1604	2	SHD-1604-U	SHD-1604-G	197.1"W X 48"H	SHD-1604-GDBL	192.6"W X 48"H
5'	SHD-1605	2	SHD-1605-U	SHD-1605-G	197.1"W X 60"H	SHD-1605-GDBL	192.6"W X 60"H
6'	SHD-1606	2	SHD-1606-U	SHD-1606-G	197.1"W X 72"H	SHD-1606-GDBL	192.6"W X 72"H

SHD-18' WIDTH							
HEIGHT	HARDWARE CODE	# OF BOXES OR CASES	UNPRINTED GRAPHIC CODE	SINGLE-SIDED GRAPHIC CODE	OUTER GRAPHIC SPECS	DOUBLE-SIDED GRAPHIC CODE	INSIDE GRAPHIC SPECS
2'	SHD-1802	2	SHD-1802-U	SHD-1802-G	221.7"W X 24"H	SHD-1802-GDBL	217.2"W X 24"H
3'	SHD-1803	2	SHD-1803-U	SHD-1803-G	221.7"W X 36"H	SHD-1803-GDBL	217.2"W X 36"H
4'	SHD-1804	2	SHD-1804-U	SHD-1804-G	221.7"W X 48"H	SHD-1804-GDBL	217.2"W X 48"H
5'	SHD-1805	2	SHD-1805-U	SHD-1805-G	221.7"W X 60"H	SHD-1805-GDBL	217.2"W X 60"H
6'	SHD-1806	2	SHD-1806-U	SHD-1806-G	221.7"W X 72"H	SHD-1806-GDBL	217.2"W X 72"H

SHD-20' WIDTH							
HEIGHT	HARDWARE CODE	# OF BOXES OR CASES	UNPRINTED GRAPHIC CODE	SINGLE-SIDED GRAPHIC CODE	OUTER GRAPHIC SPECS	DOUBLE-SIDED GRAPHIC CODE	INSIDE GRAPHIC SPECS
2'	SHD-2002	2	SHD-2002-U	SHD-2002-G	246.4"W X 24"H	SHD-2002-GDBL	241.9"W X 24"H
3'	SHD-2003	2	SHD-2003-U	SHD-2003-G	246.4"W X 36"H	SHD-2003-GDBL	241.9"W X 36"H
4'	SHD-2004	2	SHD-2004-U	SHD-2004-G	246.4"W X 48"H	SHD-2004-GDBL	241.9"W X 48"H
5'	SHD-2005	2	SHD-2005-U	SHD-2005-G	246.4"W X 60"H	SHD-2005-GDBL	241.9"W X 60"H
6'	SHD-2006	2	SHD-2006-U	SHD-2006-G	246.4"W X 72"H	SHD-2006-GDBL	241.9"W X 72"H

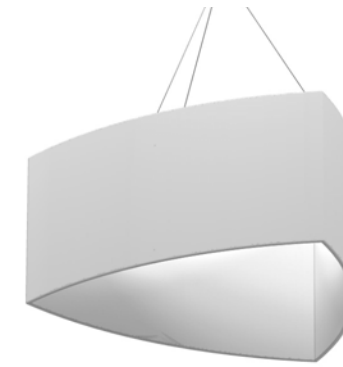

Unprinted graphic
black & white options



Single sided graphic



Double sided graphic

***ALL GRAPHIC SIZES NOTED ARE FINISHED SIZES AND DO NOT INCLUDE REQUIRED BLEEDS. REFERENCE GRAPHIC TEMPLATE.**

SHD-1003

SET UP INSTRUCTIONS:

1. CONNECT BOTTOM AND TOP TUBES FOLLOWING THE LABELS
2. CONNECT SIDE TUBES
3. CLEAN THE FRAME AND PLACE THEM ON CLEAN PLACE
4. CAREFULLY REMOVE FABRIC COVER FROM BAG
5. PLACE COVER AROUND THE BOTTOM OF THE FRAME
6. PULL COVER CAREFULLY UP TO THE TOP
7. CLOSE ALL ZIPPERS
8. ADJUST FABRIC AROUND THE FRAME
9. CONNECT CABLE HARNESS TO THE EYEBOLTS
10. COMPLETELY TIGHTEN THREADED CONNECTORS

BREAK DOWN INSTRUCTIONS:
REVERSE SET-UP STEPS TO BREAKDOWN FRAME

- FABRIC CARE INSTRUCTIONS:**
1. UNZIP COVER ZIPPERS
 2. CAREFULLY REMOVE FABRIC COVER
 3. CLOSE ALL ZIPPERS
 4. FOLD OR ROLL NEATLY
 5. PLACE FABRIC IN COVER BAG

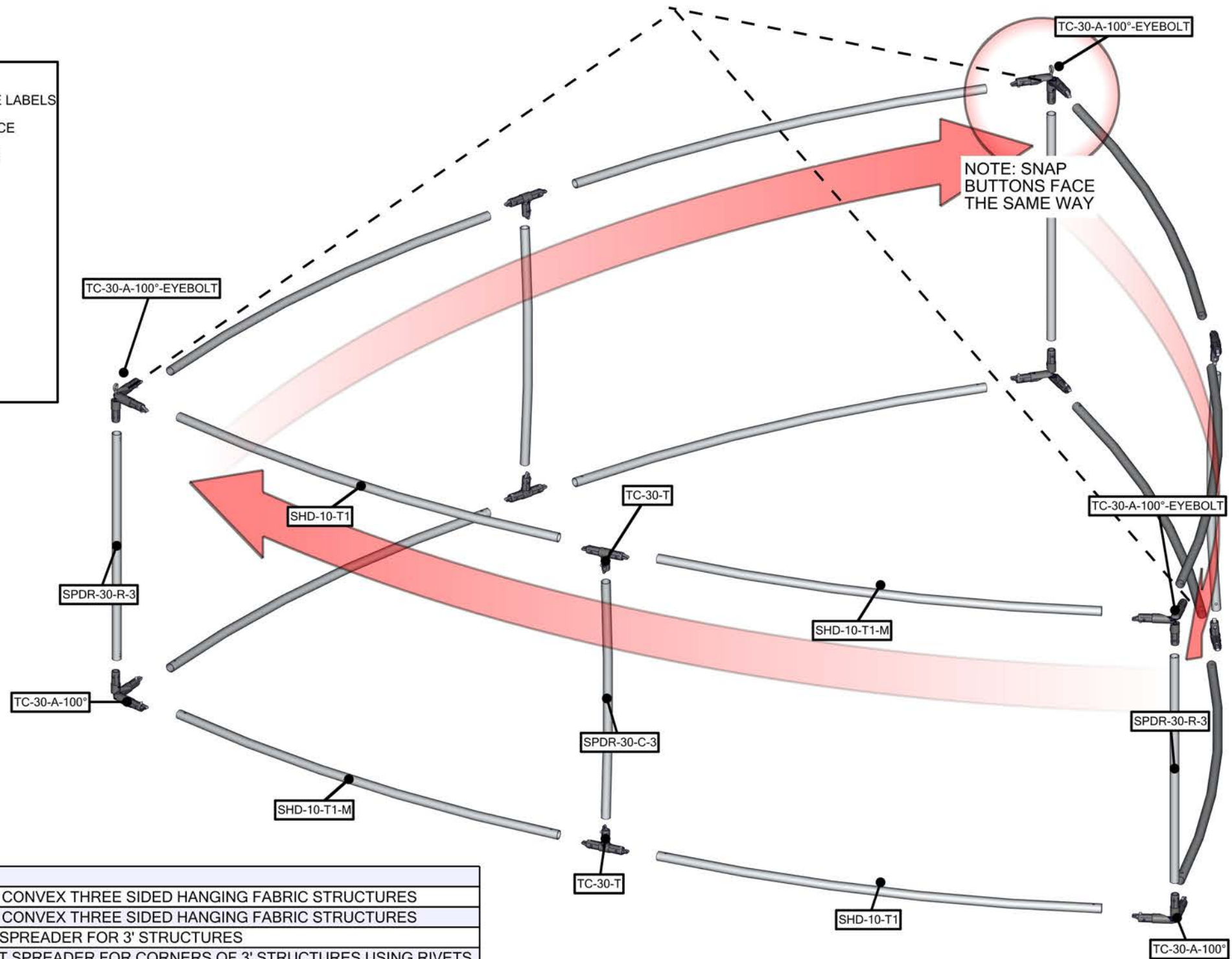

TOTAL WEIGHT: 35.8 (lbs)
MAX SIZE: 57.5 (in)
HARDWARE: 20.9 (lbs)
GRAPHIC: 12.8 (lbs)

QTY	CODE	DESCRIPTION
6	SHD-10-T1	TUBE 1 FOR 12' CONVEX THREE SIDED HANGING FABRIC STRUCTURES
6	SHD-10-T1-M	TUBE 1 FOR 12' CONVEX THREE SIDED HANGING FABRIC STRUCTURES
3	SPDR-30-C-3	30MM CURVED SPREADER FOR 3' STRUCTURES
3	SPDR-30-R-3	30MM STRAIGHT SPREADER FOR CORNERS OF 3' STRUCTURES USING RIVETS
3	TC-30-A-100°-EYEBOLT	TC-30-A ASSEMBLED at 100° WITH 1/4-20 EYE BOLT
3	TC-30-A-100°	TC-30-A ASSEMBLED at 100°
6	TC-30-T	T JUNCTION FOR 30MM TUBING

