

# Formulate Conference Wall - 02

## C-WALL-02

Whether you are looking to create a semi-private meeting area within a trade show exhibit, special event, or in an interior environment, Formulate® tension fabric conference walls are lightweight, stylish solutions to your meeting space needs. Ergonomically designed, Formulate C-shaped, Chip-shaped and Serpentine shaped walls combine the latest developments in fabric printed technology with gently curved 50mm aluminum frames to create private, cozy and stylish conference areas within any space.

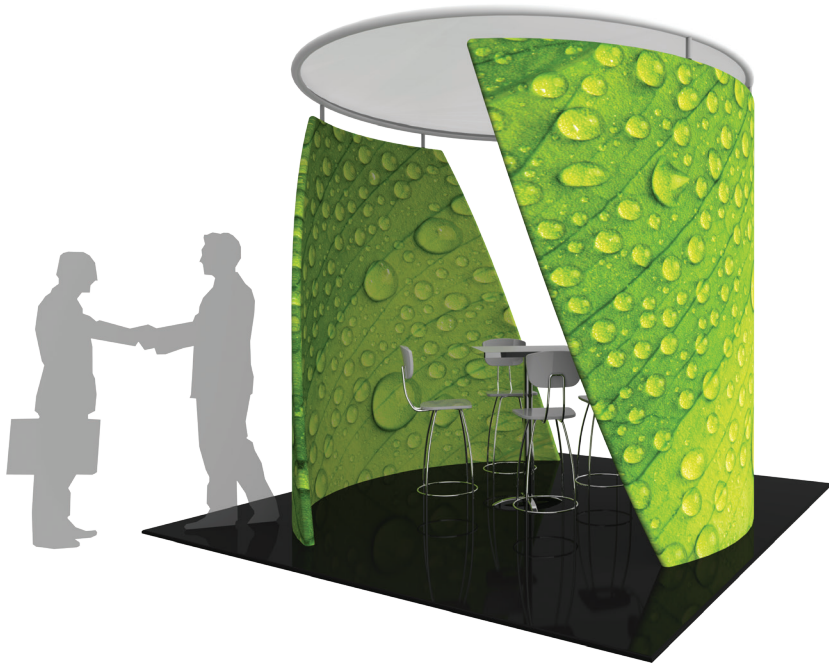

## features and benefits:

- Aluminum tube frame with snap button and spigot assembly.
- Easy to store and ship
- Quick to set up
- Three pillowcase fabric graphics
- Lifetime limited hardware warranty against manufacturer defects

## dimensions:

Hardware	Graphic
<p>Assembled unit: 108"w x 102.4"h x 108"d 2743mm(w) x 2592mm(h) x 2743mm(d)</p> <p>Approximate weight: 121 lb / 54.88 kg</p>	<p>Refer to related graphic template for more information.</p> <p>Visit: <a href="http://www.exhibitors-handbook.com/graphic-templates">www.exhibitors-handbook.com/graphic-templates</a></p>
Shipping	
<p>Packing case(s): 1 OCE-2 Case</p> <p>Shipping dimensions: OCE-2: Expandable case length (l) may vary 40" - 66"l x 18"h x 18"d 1016mm-1677mm(l) x 458mm(h) x 458mm(d)</p> <p>Approximate total shipping weight (includes cases &amp; graphics): 145 lb / 65.59 kg</p>	

## additional information:

Graphic material:  
dye-sublimation zipper pillowcase fabric

We are continually improving and modifying our product range and reserve the right to vary the specifications without prior notice. All dimensions and weights quoted are approximate and we accept no responsibility for variance. E&OE. See Graphic Templates for graphic bleed specifications.

# Included In Your Kit

Tools, Components,  
& Connectors



ALLEN KEY SET x1

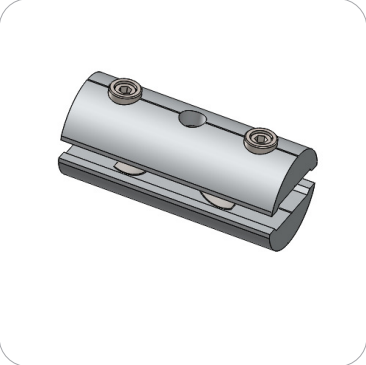

ES50 x24

Graphics



C-WALL-02-A-G x1



C-WALL-02-B-G x1

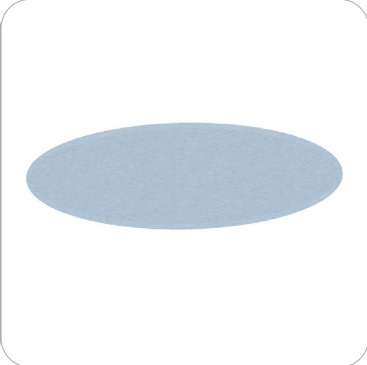

C-WALL-02-C-G x1

# Included In Your Kit

Tubes



C-WALL-02-A-T1 x1



C-WALL-02-A-T2 x1



C-WALL-02-A-T3 x1



C-WALL-02-A-T4 x1



C-WALL-02-A-T5 x1

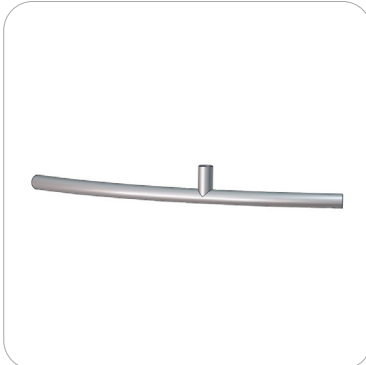

C-WALL-02-A-T6 x1



C-WALL-02-A-T7 x1



C-WALL-02-A-T8 x1

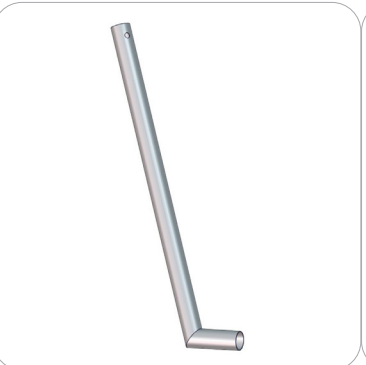

C-WALL-02-A-T9 x1



C-WALL-02-B-T1 x1



C-WALL-02-B-T2 x1

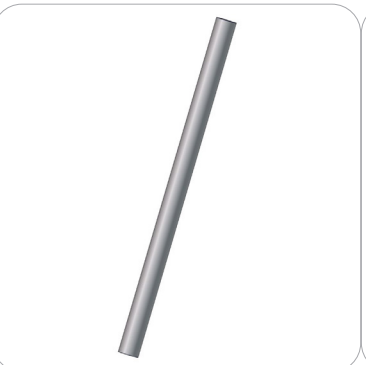

C-WALL-02-B-T3 x2



C-WALL-02-B-T4 x1



C-WALL-02-B-T5 x1



C-WALL-02-B-T6 x1

# Included In Your Kit



C-WALL-02-B-T7 x1



C-WALL-02-B-T8 x1



C-WALL-02-C-T1 x1



C-WALL-02-C-T2 x4



C-WALL-02-C-T3 x1

Tubes



C-WALL-02-T8 x2



C-WALL-02-T9 x2

# Exploded View

## C-WALL-02

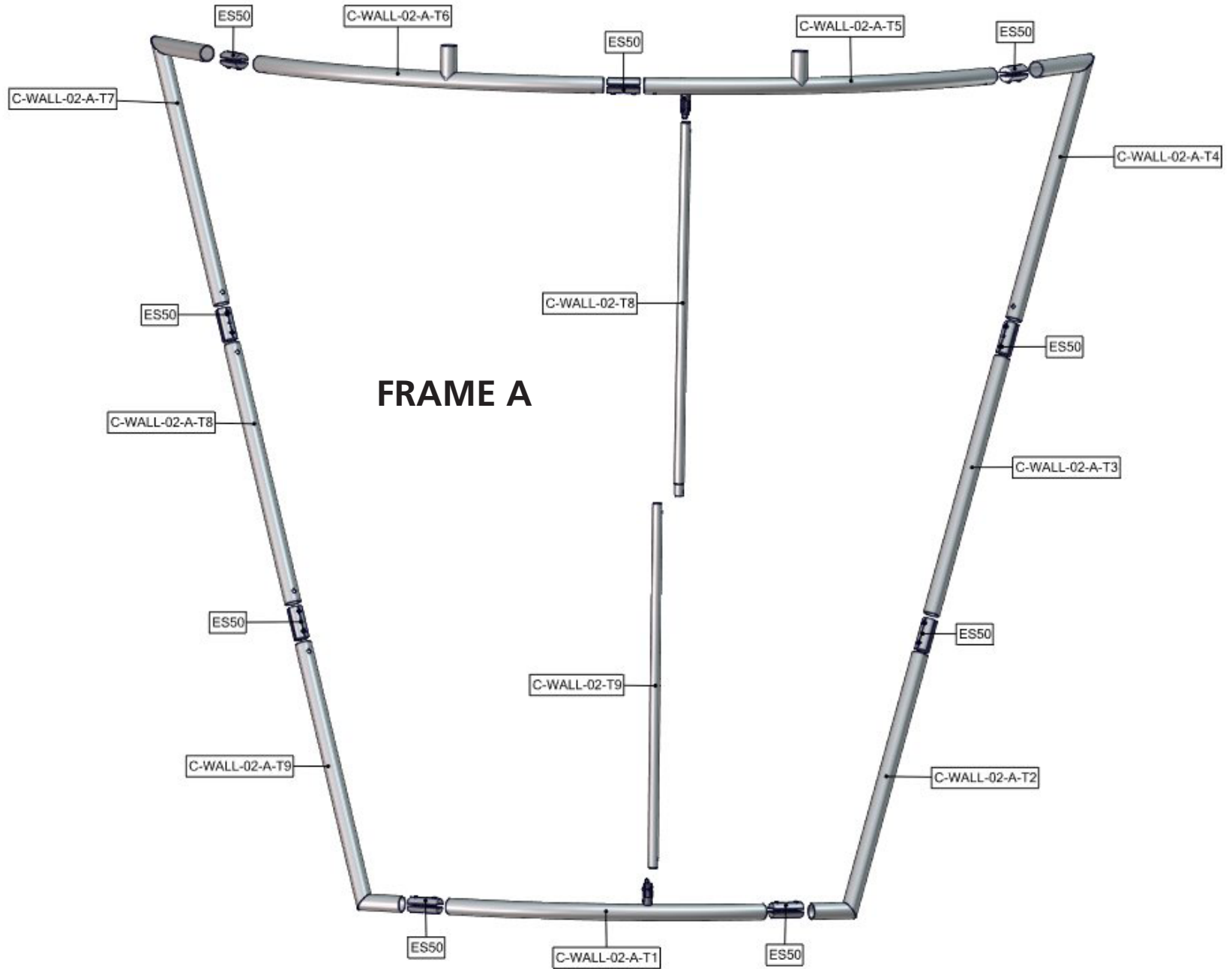

# Exploded View

## C-WALL-02

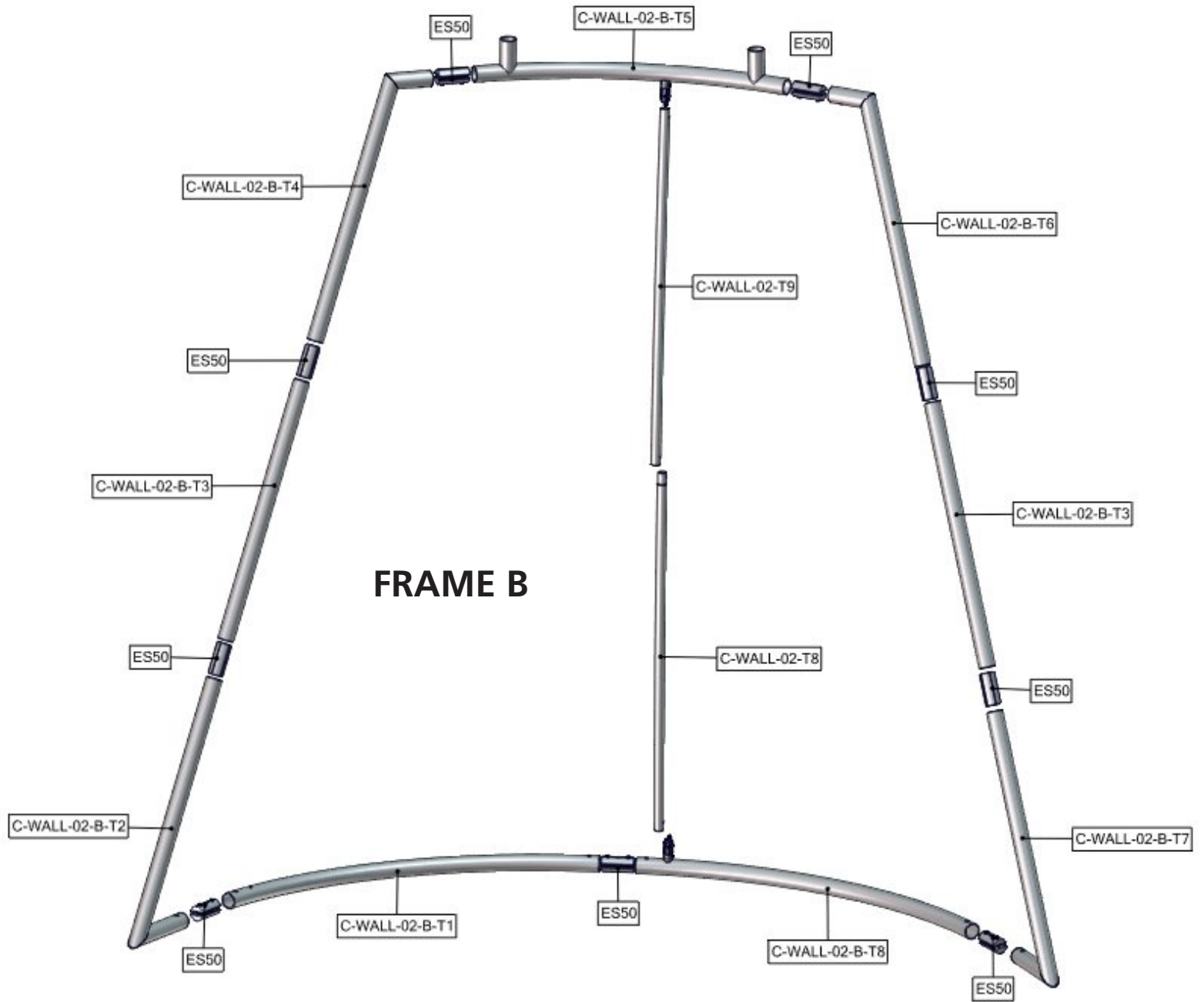

# Exploded View

## C-WALL-02

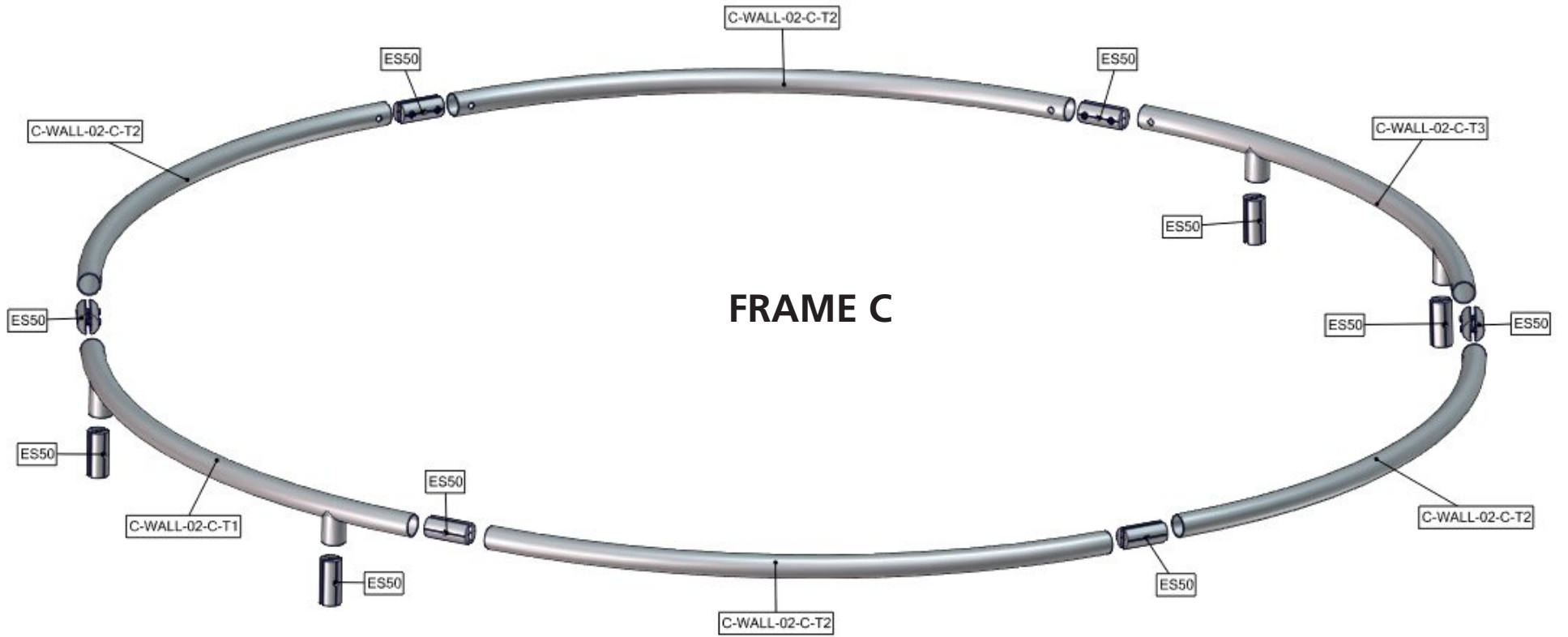

# Labeling Diagram

C-WALL-02

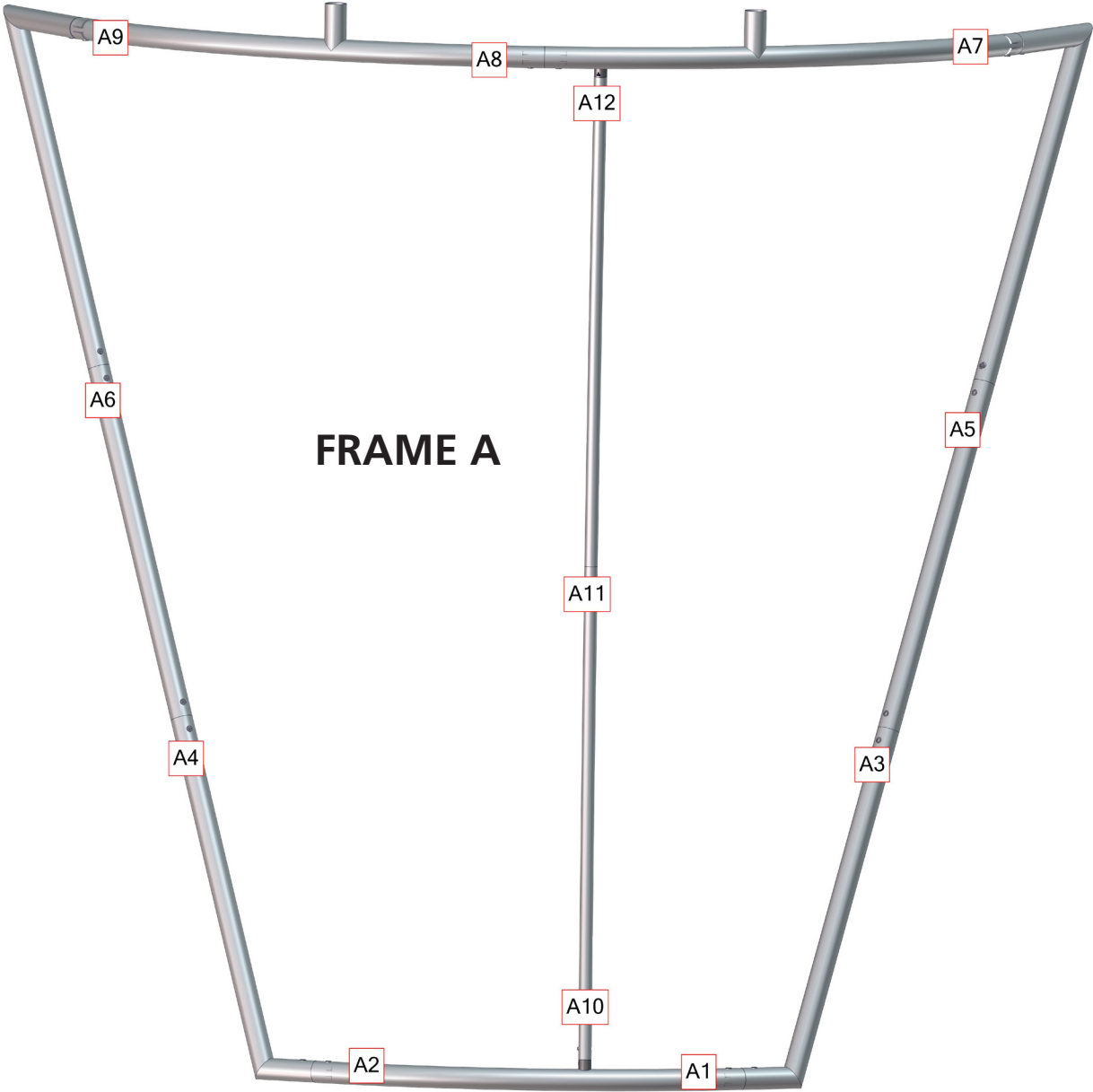



# Labeling Diagram

C-WALL-02

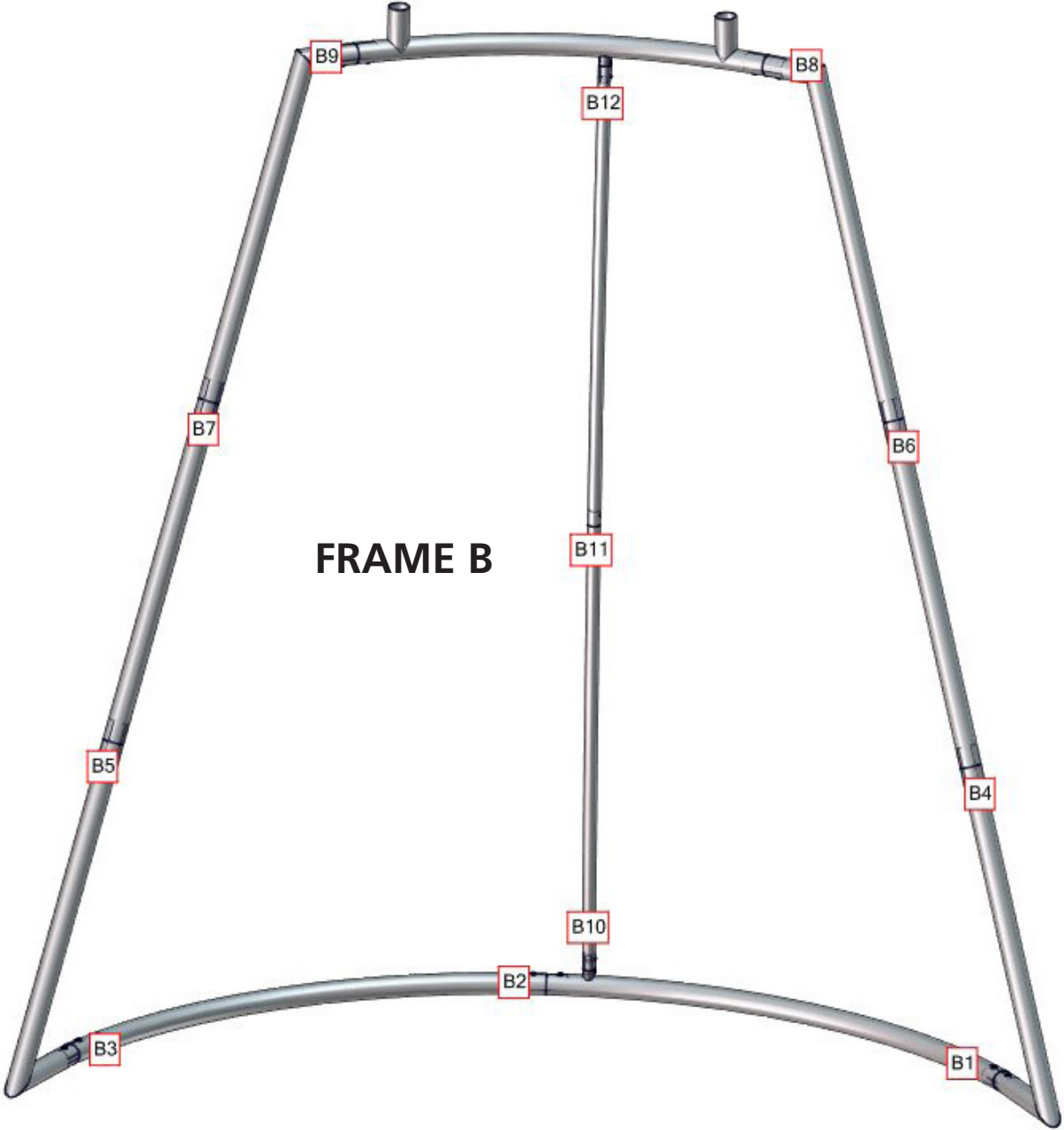

# Labeling Diagram

C-WALL-02

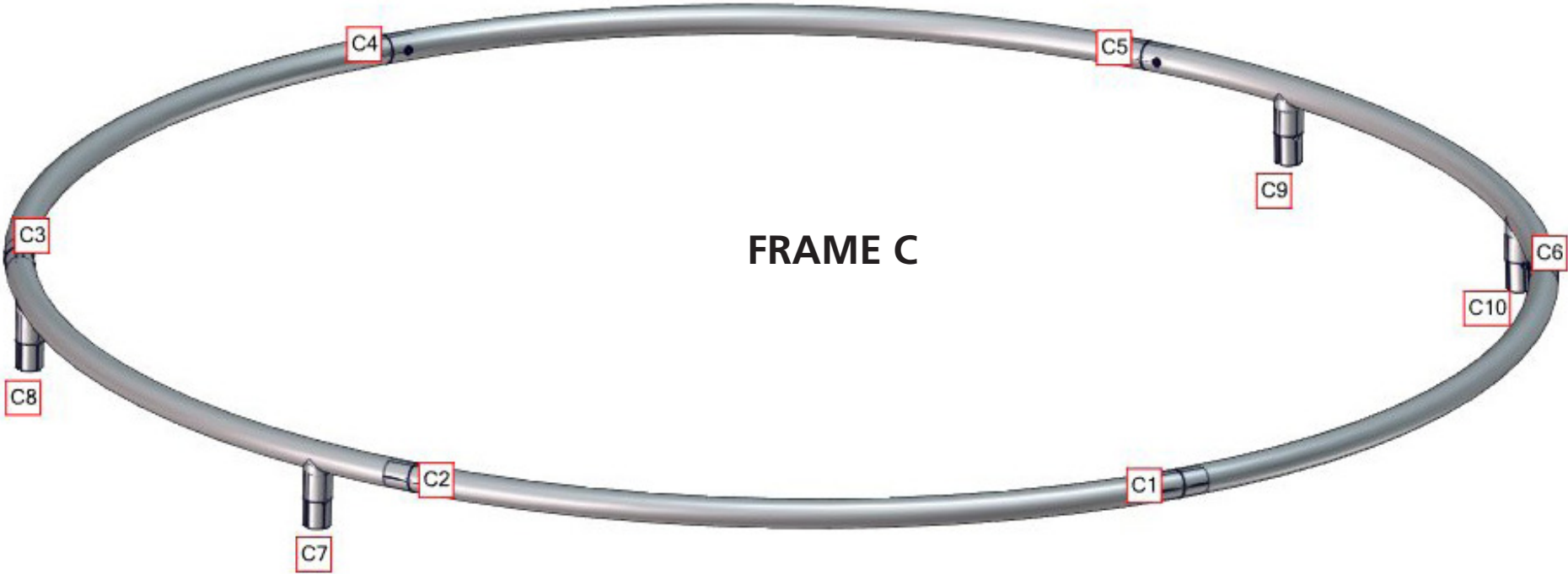

# Connection Methods

Formulate® structures use a number of different yet simple connection methods. Your kit will include one or more of the connection methods shown below. Steps within the Kit Assembly will reference a specific method for each connection point.

## Connection Method 1: ES30 / ES50 / ES75

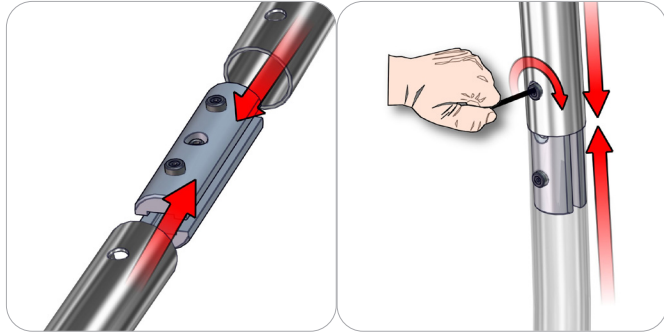

Compress the unlocked connector and slide one tube onto each end. Lock both screws carefully using your allen key tool. Be sure to lock securely, but do not overtighten.

## Connection Method 2: Snap Buttons & Swage

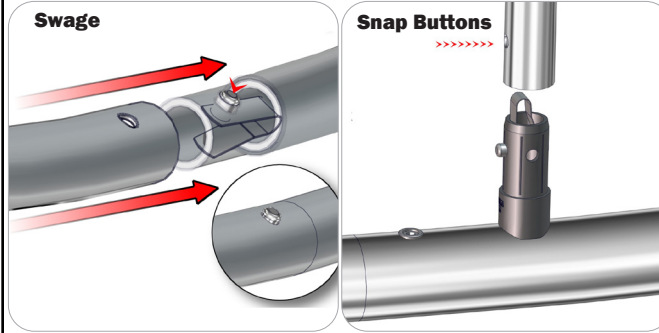

Locate the snap button on the connector or swage tube. Locate the hole on the corresponding tube. Press the snap button with your thumb and slide the tube and connector together so that the snap button snaps fully into the lock hole. To disassemble, press the snap button and pull apart.

## Connection Method 3: ES30-90B / ES30-I / ES30-C

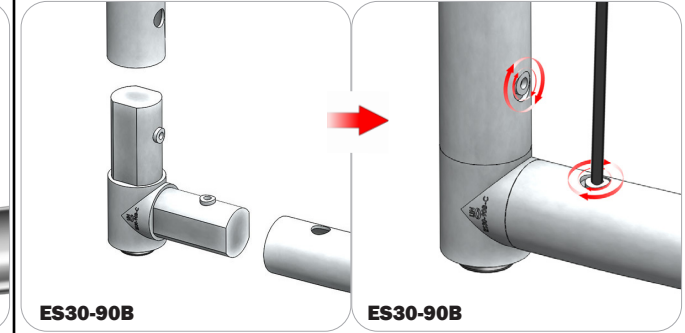

Compress one unlocked end of the connector and slide it through one tube end. Compress the other end of the connector and slide the second tube on. Lock both screws carefully using your allen key tool. Be sure to lock securely, but do not overtighten.

## Connection Method 4: Tube Clamps

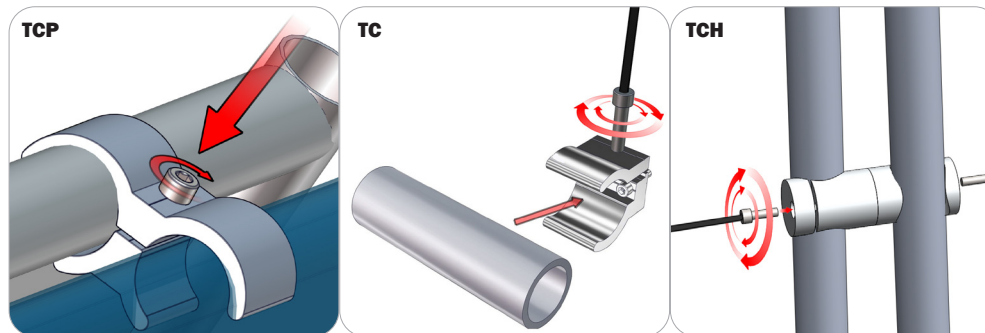

Be sure to fully assemble all frames before using clamps. With the clamp unlocked, place one tube of the first frame into the mouth of the clamp. Place the second tube (if applicable) into the second mouth of the clamp. With both frame's tubes in the clamp, be sure to lock securely, but do not overtighten.

# Kit Assembly

## Step by Step

### Step 1.

Locate the components necessary for assembling Frame A referenced in the exploded view. Assemble the frame in order according to the Labeling Diagram.

Please reference Connection Method 1 for more details.



### Step 2.

Apply graphic to Frame A. For ease of installation, pull the fabric cover from the bottom to the top of the frame while the frame rests flat on the floor. Zip to enclose.



### Step 3.

Locate the components necessary for assembling Frame B referenced in the exploded view. Assemble the frame in order according to the Labeling Diagram.

Please reference Connection Method 1 for more details.



### Step 4.

Apply graphic to Frame B. For ease of installation, pull the fabric cover from the top to the bottom of the frame while the frame rests flat on the floor. Zip to enclose.



# Kit Assembly

## Step by Step

### Step 5.

Locate the components necessary for assembling Frame C referenced in the exploded view. Assemble the frame in order according to the Labeling Diagram.

Please reference Connection Method 1 for more details.



### Step 6.

Apply graphic to Frame C. Pull the fabric cover over frame while the frame rests flat on the floor. Zip to enclose.



### Step 7.

Place frame C above frame A and B, and attach using connection method 1.

Assembly complete.

