

Comfort **Dura**

Portable Air Conditioner

Note:

Strictest operation environment:

Cooling mode: 18°C-35°C (64°F-95°F)

Heating mode: 10°C-25°C (50°F-77°F)

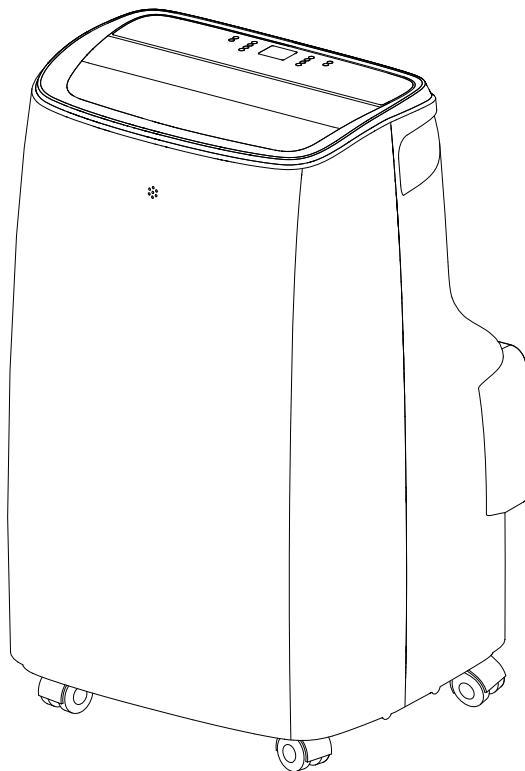

MODEL:

DP08CD (Cooling only)

DP10CD (Cooling only)

DP11CD (Cooling only)



Thank you for selecting our quality appliance. Please be sure to read this user manual carefully before using. Any question, please contact the professional service for help.

IMPORTANT SAFEGUARDS

- This appliance is for household use only.
- Disconnect the appliance from its power source during service and when replacing parts and cleaning.
- Please note: Check the nameplate for the type of refrigerant gas used in your appliance.
- Specific information regarding appliances with refrigerant gas.

The appliance is recommended not to pierce the cooling circuit of the machine. At the end of its useful life, deliver the appliance to a special waste collection centre for disposal.

GWP(Global Warming Potential): R410A: 2088, R134a: 1430, R290: 3, R32: 675.

- This hermetically sealed system contains fluoridated greenhouse gases.
- ENVIRONMENTAL INFORMATION: This unit contains fluoridated greenhouse gases covered by the Kyoto Protocol.
- Do not use this unit for functions other than those described in this instruction manual.
- Make sure the plug is plugged firmly and completely into the outlet. It can result in the risk of electric shock or fire.
- Do not plug other appliances into the same outlet, it can result in the risk of electric shock.
- Do not disassemble or modify the appliance or the power cord, it can result in the risk of electric shock or fire. All other services should be referred to a qualified technician.
- Do not place the power cord or appliance near a heater, radiator, or other heat source. It can result in the risk of electric shock or fire.
- This unit is equipped with a cord that has a earthed wire connected to an earthed pin or grounding tab. The plug must be plugged into a socket that is properly installed and earthed. Do not under any circumstances cut or remove the earthed pin or grounding tab from this plug.
- The unit should be used or store in such a way that it is protected from moisture e.g. condensation, splashed water, etc. Unplug unit immediately if this occurs.
- Always transport your appliance in a vertical position and place on a stable, level surface during use. If the unit is transported laying on its side it should be stood up and left unplugged for 6 hours.
- Always use the switch on the control panel or remote controller to turn the unit off, and do not start or stop operation by plugging in or unplugging the power cord. It can result in the risk of electric shock.
- Do not touch the buttons on the control panel with your wet and damp fingers.
- Do not use hazardous chemicals to clean or come into contact with the unit. To prevent damage to the surface finish, use only a soft cloth to clean the appliance. Do not use wax, thinner, or a strong detergent. Do not use the unit in the presence of inflammable substance or vapour such as alcohol, insecticides, gasoline, etc.
- If the appliance is making unusual sounds or is emitting smoke or an unusual odor, unplug it immediately.
- Do not clean the unit with water. Water can enter the unit and damage the insulation, creating a shock hazard. If water enters the unit, unplug it immediately and contact Customer Service.
- Utilize two or more people to lift and install the unit.

- Always grasp the plug when plugging in or unplugging the appliance. Never unplug by pulling on the cord. It can result in the risk of electrical shock and damage.
- Install the appliance on a sturdy, level floor capable of supporting up to 110lbs(50kg). Installation on a weak or unlevel floor can result in the risk of property damage and personal injury.
- If the appliance have the Wi-Fi function , the transmission power: less than 20dBm, and the radio frequency range is: 2412MHz-2472MHz.

This appliance is not intended for use by persons (including children)with reduced physical, sensory or mental capabilities,or lack of experience and knowledge, unless they have been given supervision or instruction concerning use of the appliance by a person responsible for their safety.

Children should be supervised to ensure that they do not play with the appliance.

If the SUPPLY CORD is damaged, it must be replaced by the manufacturer, its service agent or similarly qualified persons in order to avoid a hazard.

The appliance shall be installed in accordance with national wiring regulations.

Cet appareil n'est pas destiné à être utilisé par des personnes (y compris des enfants) ayant des capacités physiques, sensorielles ou mentales réduites, ou un manque d'expérience et de connaissances, sauf si elles ont reçu une supervision ou des instructions concernant l'utilisation de l'appareil par une personne responsable de leur sécurité.

Les enfants doivent être surveillés pour s'assurer qu'ils ne jouent pas avec l'appareil.

Si le CORDON D'ALIMENTATION est endommagé, il doit être remplacé par le fabricant, son agent de service ou des personnes de qualification similaire afin d'éviter tout danger.

L'appareil doit être installé conformément aux réglementations de câblage nationales.

SAFETY INFORMATION

 DANGER	 WARNING	 CAUTION
DANGER - Immediate hazards which WILL result in severe personal injury or death	WARNING - Hazards or unsafe practices which COULD result in severe personal injury or death	CAUTION - Hazards or unsafe practices which COULD result in minor personal injury

IMPORTANT SAFETY INSTRUCTIONS

 WARNING
When using electrical appliances, basic safety precautions should be followed, including the following

1. Should fluid from the battery accidentally get into your eyes, there is a threat of loss of eyesight, do not rub them. Immediately.
2. Do not put the battery in a fire, expose it to heat, dismantle or modify it. If the insulation or safety valve is damaged, the battery may leak fluid, overheat or explode.
3. Do not insert the battery with the poles reversed. Doing so may cause some abnormality or a short and the battery may leak fluid, overheat or explode.
4. Keep the battery out of the reach of children. If the battery is swallowed, contact a physician immediately.
5. If the alkali fluid gets on your skin or clothes, it may burn your skin, thoroughly rinse the affected area with tap water and contact a physician immediately.
6. If the alkali fluid gets on your skin or clothes, it may burn your skin, thoroughly rinse the affected area with tap water.
7. Do not mix new and old batteries or other makes of batteries. The different attributes may cause the battery to leak fluid, overheat or explode.
8. This battery was not made to be recharged. Recharging this battery may damage the insulation or internal structure and may cause the battery to leak fluid, overheat or explode.
9. Do not damage or remove the label on the exterior of the battery. Doing so may cause the battery to short, leak fluid, overheat or explode.
10. Do not drop, throw or expose the battery to extreme impact. Doing so may cause the battery to leak fluid, overheat or explode.
11. Do not alter the shape of the battery. If the insulation or safety valve is damaged, the battery may leak fluid, overheat or explode.
12. Immediately remove the batteries when they have lost all power. Leaving the batteries in the unit for a long time may cause the batteries to leak fluid, overheat or explode due to gas that is generated by the batteries.
13. Remove the batteries from the unit when not using the unit for an extended period of time. The batteries may leak fluid, overheat or explode due to gas that is generated by the batteries.
14. Do not apply solder directly to the batteries. The heat may cause the batteries to leak fluid, overheat or explode.
15. Do not get the batteries wet. Doing so may cause the batteries to overheat.
16. Store batteries someplace out of direct sunlight where the temperature and humidity are not high. Not doing so may cause the batteries to leak fluid, overheat or explode. Also, it may cause the life and performance of the batteries to decline.
17. Follow the regulations of the local government when disposing of these batteries.
18. NEVER mix alkaline, standard (carbon-zinc), rechargeable (nickel-cadmium) batteries with this product.

SAVE THESE INSTRUCTIONS HOUSEHOLD USE ONLY

GROUNDING INSTRUCTIONS

ELECTRICAL REQUIREMENTS

In the event of malfunction or breakdown, grounding provides a path of least resistance for electric current to reduce the risk of electric shock.

The appliance must be connected to a cord having an equipment grounding conductor and a grounding plug. The plug must be plugged into an appropriate outlet that is properly installed and grounded in accordance with all local and ordinances.

ELECTRICAL SHOCK HAZARD

- Plug into a grounded 3 prong outlet.
- Do not remove the ground prong.
- Do not use an adapter.
- Do not use an extension cord.
- Failure to follow these instructions can result in death, fire, or electrical shock.

PREFERRED GROUNDING METHOD

60Hz, 115V AC outlet protected by a 15 amp time delay fuse or circuit breaker.

INTEGRATED CIRCUIT BREAKER

For additional safety, the power cord features an integrated circuit breaker. Test and reset buttons are provided on the plug case.

The circuit breaker should be tested periodically by pressing the **TEST** button. If it does not cause the circuit breaker to trip, or if the **RESET** button will not stay engaged, unplug the appliance immediately and contact your service technician.

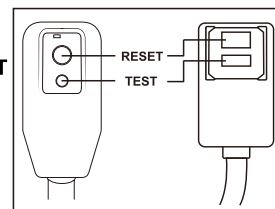

Note: Your appliance's power cord and plug may differ from above the picture shows.

PREFERRED GROUNDING METHOD

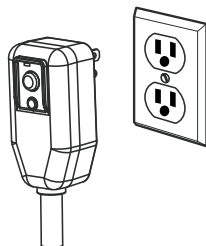

Ensure proper ground exists before use.

TEMPORARY GROUNDING METHOD

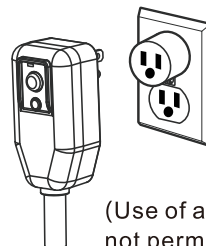

Ensure proper ground exists before use.

(Use of adapter plugs is not permitted in Canada)



DANGER - Improper connection of the equipment grounding conductor can result in a

risk of electric shock. The conductor with insulation having an outer surface that is green with or without yellow stripes is the equipment grounding conductor. If repair or replacement of the Cord or plug is necessary, do not connect the equipment-grounding conductor to a live terminal. Check with a qualified electrician or service person if the grounding instructions are not completely understood, or if in doubt as to whether the appliance is properly grounded. Do not modify the plug connected to the appliance - if it will not fit the outlet, have a proper outlet installed by a qualified electrician.

WARNING

1. This appliance is not intended for use by persons (including children) with reduced physical, sensory or mental capabilities, or lack of experience and knowledge, unless they have been given supervision or instruction concerning use of the appliance by a person responsible for their safety.
2. Children should be supervised to ensure that they do not play with the appliance.
3. If the SUPPLY CORD is damaged, it must be replaced by the manufacturer, its service agent or similarly qualified persons in order to avoid a hazard.
4. The appliance shall be installed in accordance with national wiring regulations.
5. Do not use means to accelerate the defrosting process or to clean, other than those recommended by the manufacturer.
6. The appliance shall be stored in a room without continuously operating ignition sources (for example: open flames, an operating gas appliance or an operating electric heater).
7. Do not pierce or burn.
8. Be aware that refrigerants may not contain an odour.

AVERTISSEMENT

1. Cet appareil n'est pas destiné à être utilisé par des personnes (y compris des enfants) ayant des capacités physiques, sensorielles ou mentales réduites, ou un manque d'expérience et de connaissances, sauf si elles ont reçu une supervision ou des instructions concernant l'utilisation de l'appareil par une personne responsable de leur sécurité.
2. Les enfants doivent être surveillés pour s'assurer qu'ils ne jouent pas avec l'appareil.
3. Si le CORDON D'ALIMENTATION est endommagé, il doit être remplacé par le fabricant, son agent de service ou des personnes de qualification similaire afin d'éviter tout danger.
4. L'appareil doit être installé conformément aux réglementations de câblage nationales.
5. Ne pas utiliser de produits permettant d'accélérer le dégel ou de produits de nettoyage autres que ceux recommandés par le fabricant.
6. L'appareil doit être entreposé dans un endroit sans source d'allumage fonctionnant en continu (par exemple : flamme nue, appareil au gaz en marche ou radiateur électrique en marche).
7. Ne pas percer ni brûler.
8. Attention : les frigorigènes peuvent être inodores.

The following information is also specified in the manual for units with flammable refrigerant (R32).

[x] the maximum refrigerant charge amount (*Refer to nameplate marking refrigerant amount*);

[x] information for handling, installation, cleaning, servicing and disposal of refrigerant;

[x] a warning to keep any required ventilation openings clear of obstruction;

[x] a notice that servicing shall be performed only as recommended by the manufacturer.

[x] a warning that the appliance shall be stored in a well-ventilated area where the room size corresponds to the room area as specified for operation;

[x] a warning that the appliance shall be stored in a room without continuously operating open flames (for example an operating gas appliance) and ignition sources (for example an operating electric heater).

[x] instructions as to how the appliance is to be stored so as to prevent mechanical damage from occurring.

[x] specific information about the required qualification of the working personnel for maintenance, service and repair operations.

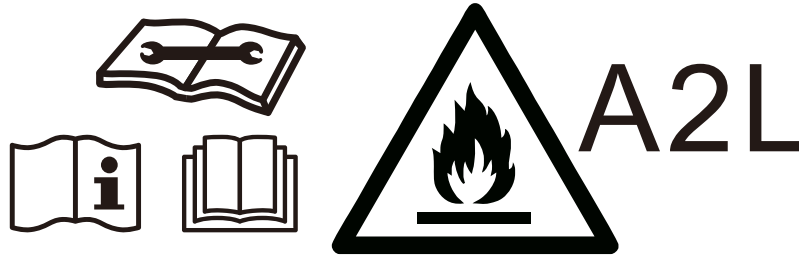

WARNING

The handling, installation, storage, servicing and disposal must comply with the provisions of gas-related national laws and regulations, and also national wiring regulation.

It is necessary to clear away the refrigerant in the system when maintaining or scrapping an appliance.

Ventilated area (open doors and Windows)

Ensure that the working area is open or well ventilated before turning on the system or performing hot work. Ventilation should be maintained during operation. Ventilation quickly displaces safely diluted leaked refrigerant into the atmosphere.

Flammable refrigerant R32/R290 is used within appliance. Please follow the instructions carefully to handle, install, clean, and service the appliance to avoid damage or hazard. Do not dispose of appliance in regular trash. Contact qualified agency for proper disposal.

Servicing shall be performed only as recommended by the manufacturer.



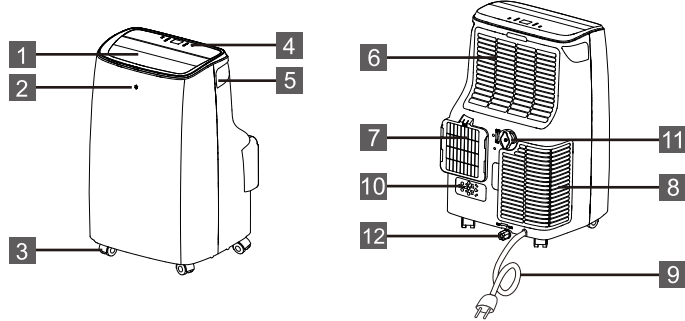

DESCRIPTION

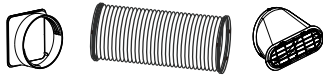
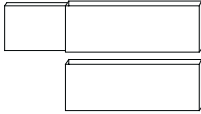

1. Deflector	7. Air outlet grille
2. Remote control receiver	8. Intake grille
3. Castors	9. Power cable
4. Control panel	10. Plug fixer
5. Handle (both sides)	11. Middle drainage
6. Intake grille	12. Condenser drain

ACCESSORIES

Please make sure all accessories are removed from their packing materials before use.

PARTS	PARTS NAME	QUANTITY
	Hose inlet Exhaust hose Hose outlet	1 set
	Window slider kit (Window slider without hole)	1 set
	Remote control Battery	1 set
	Foam seal	1 set
	6 Bolts (Metal locking screw)	6 pieces

Note:

All the illustrations in this manual are for explanatory purposes only. Your appliance may be slightly different.

Be sure all accessories are removed from the packing before use.

INSTALLATION INSTRUCTIONS EXHAUSTING HOT AIR

When use the appliance in cool mode, the hot air exchange of the condenser must be exhausted out of the room completely.

First position unit on a flat floor and make sure there's a minimum of 18" (45cm) clearance around the unit, and is within the vicinity of a single circuit outlet power source.

1. Align the both arrow of hose inlet connector and hose, insert; (Fig. 1)
2. Rotary the hose inlet connector Clockwise or counterclockwise about 60°; (Fig. 1)
3. Use the same way to connect the hose outlet and hose; (Fig. 2)
4. After assemble, like below fig. (Fig. 3)
5. Install the hose inlet into the unit (Fig.4).
6. Affix the hose outlet into the window slider kit and seal. (Fig.5 &6).

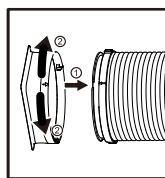

Fig. 1

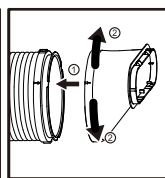

Fig. 2

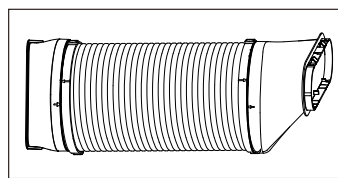

Fig. 3

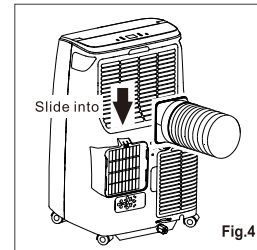

Fig.4

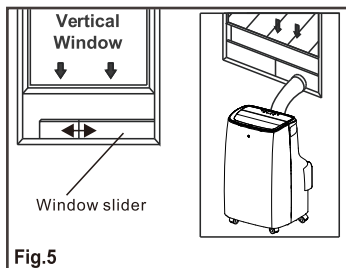

Fig.5

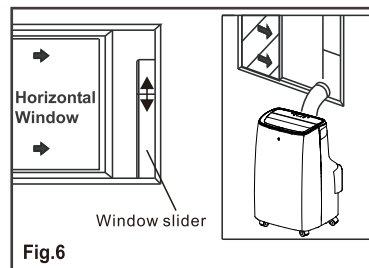
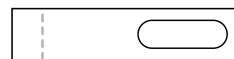

Fig.6

The window slider kit has been designed to fit most standard vertical and horizontal window applications, however, it may be necessary for you to modify some aspects of the installation procedures for certain types of windows. The window slider kit can be fastened with screws.

NOTE:

If the window opening is less than the minimum length of the window slider kit, cut the end without the hold in it short enough to fit in the window opening. Never cut out the hole in window slider kit.



● Cut on opposite side of hole.

DOUBLE-HUNG SASH/SLIDING CASEMENT WINDOW INSTALLATION

1. Cut the foam seal(adhesive type) to the proper length and attach it to the window sash.
2. Attach the window slider kit to the window sash. Adjust the length of the window slider kit according to the width of window. If necessary, mark the kit and cut one end down to properly fit the window.
3. Cut the foam seal(adhesive type) to the proper length and attach it on the top of the window.
4. Close the window securely against the window slider kit.
5. Secure the window slider kit to the window sash.
6. Cut the foam seal to an appropriate length and seal the open gap between the top window frame and outer window frame.

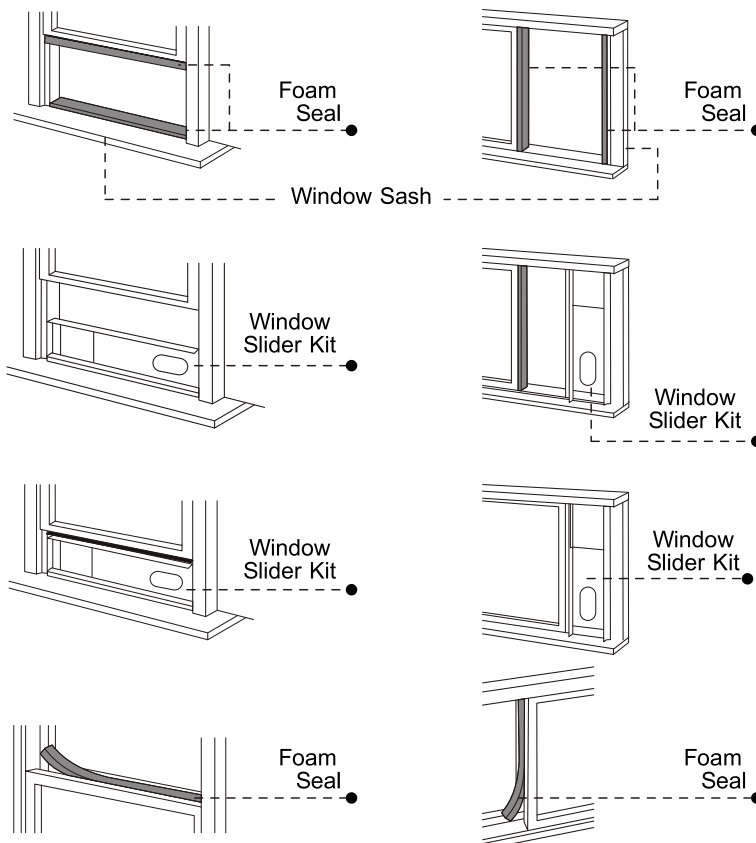

WINDOW SLIDER KIT INSTALLATION

1:Parts:

- A) Panel
- B) Panel with one hole
- C) Panel without hole
- D) Screw to lock window kit in place

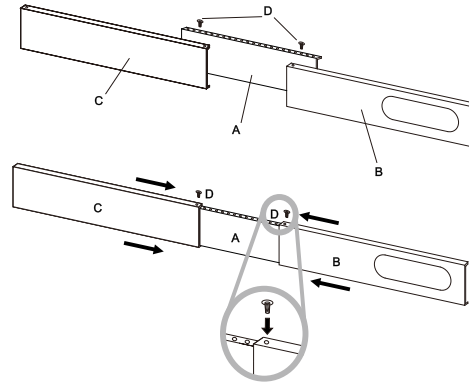

2: Assembly:

Slide Panel B and C into Panel A and size to window width. Windows sizes vary. When sizing the window width, be sure that the window kit assembly is free from gaps from gaps and/or air pockets when taking measurements.

3.Lock the screw into the holes that correspond

With the width that your window requires to ensure that there are no gaps or air pockets in the window kit assembly after installation.

LOCATION

- The unit should be placed on a firm foundation to minimize noise and vibration. For safe and secure positioning place the unit on a smooth, level floor strong enough to support the unit.
- The unit has casters to aid placement, but it should only be rolled on smooth, flat surfaces. Use caution when rolling on carpeted surfaces. Use caution and protect floors when rolling over wood floors. Do not attempt to roll the unit over objects.
- The unit must be placed within reach of a properly rated grounded socket.
- Never place any obstacles around the air inlet or outlet of the unit.
- Allow at least 18"(45cm) of around and above space away from the wall for efficient working.
- The hose can be extended, but it is the best to keep the length to minimum required. Also make sure that the hose does not have any sharp bends or sags.

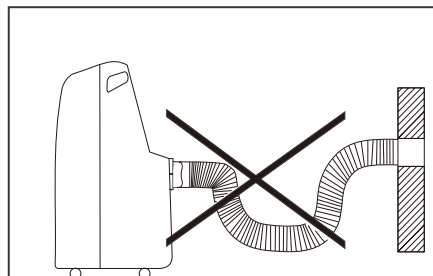
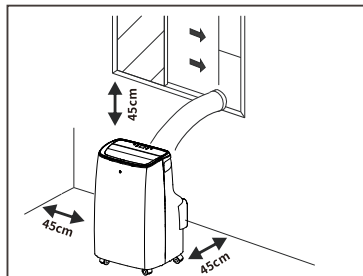

DESCRIPTION OF THE DISPLAY SCREEN AND CONTROL PANEL

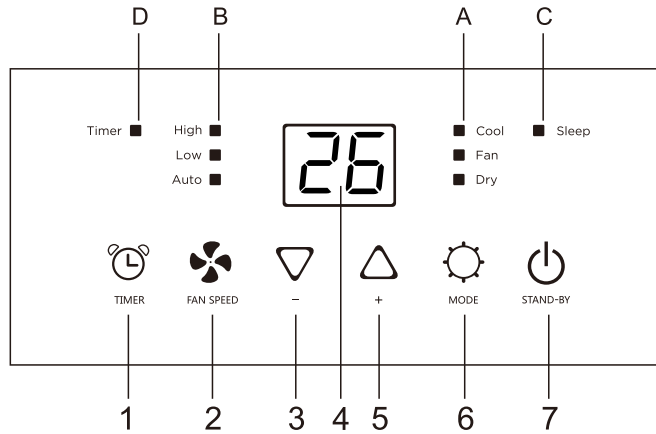

- | | |
|--------------------|--------------------|
| 1.Timer button | A Mode symbol |
| 2.Fan speed button | B Fan speed symbol |
| 3.Decrease button | C Sleep symbol |
| 4.Display screen | D Timer symbol |
| 5.Increase button | |
| 6.MODE button | |
| 7.STAND-BY button | |

TURNING THE APPLIANCE ON





Plug into the mains socket, then the appliance is standby. Press the  button to make the appliance turn on. The last function active when it was turned off will appear.



COOL mode

Ideal for hot muggy weather when you need to cooling and dehumidify the room.

To set this mode correctly:



- Press the  button a number of times until the "Cool" symbol appears.
- Select the target temperature 18°C-32°C (64°F-90°F) by pressing the  or  button until the corresponding value is displayed.
- Select the required fan speed by pressing the  button.
Three speeds are available: High / Low / Auto.



The most suitable temperature for the room during the summer varies from 24°C to 27°C (75°F to 81°F). You are recommended, however, not to set a temperature much below the outdoor temperature. The fan speed difference is more noticeable when the appliance is under Fan mode but may not be noticeable under Cool mode.

FAN mode

When using the appliance in this mode, the air hose does not need to be attached.

- Press the  button a number of times until the “Fan” symbol appears.
- Select the required fan speed by pressing the  button.

Two speeds are available: High / Low.

The screen display “” as high speed, “” as low speed.





DRY mode

Ideal to reduce room humidity (spring and autumn, damp rooms rainy periods, etc).

In dry mode, the appliance should be prepared in the same way as for cool mode, with the air exhaust hose attached to enable the moisture to be discharged outside.

To set this mode correctly:

- Press the  button a number of times until the

Dry symbol appears. The screen display “”.



- In this mode, fan speed is selected automatically by the appliance and can not be set manually.

SMART mode

The appliance chooses automatically whether to operate in cool or fan mode.

To set this mode correctly:

- Press the  button a number of times until the screen show like below:

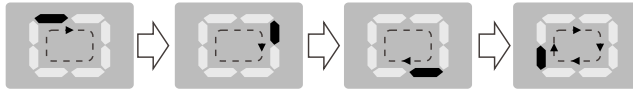

- Select the required fan speed by pressing the  button.

Three speeds are available: High / Low / Auto.

If the appliance is cooling only model, the unit operates in Fan mode

when the room temperature is below 23°C (73°F), and Cool mode when the room temperature is above 23°C (73°F).



If the appliance is cooling and heating model, the unit operates in Heat mode when the room temperature is below 20°C (68°F), and Fan mode when the room temperature is from 20°C (68°F) to 23°C (73°F), and Cool mode when the room temperature is above 23°C (73°F).

SETTING THE TIMER



-This timer can be used to delay the appliance start-up or shutdown, this avoids wasting electricity by optimizing operating periods.

* Programming start-up

- Turn on the appliance, choose the mode you want, for example Dehumidify mode, high fan speed.
- Turn off the appliance.

- Press the "  " button , the screen starts to flash, press the " Δ " / " ∇ " to adjust the set time from 0.5-24 hours.
- In 5 seconds without the operation, the timer start function, then the "Timer" symbol lights.
- Press the "  " button again to cancel the Timer, and the "Timer" symbol disappear.

*** Programming shut down**

- When the appliance is running, press the "  " button, the screen starts to flash. - Press the " Δ " / " ∇ " to adjust the set time from 0.5-24 hours.
- In 5 seconds without the operation, the timer start function, then the " Timer" symbol lights.
- Press the "  " button again to cancel the Timer, and the " Timer " symbol disappear.

Switch the unit of temperature °C/°F

When the appliance is running, hold on " Δ " and " ∇ " button together 3 seconds by the same time, then you can change the unit of temperature.

For example:

Before change, in cool mode, the screen display like fig1.



Fig.1





Fig.2

After change, in cool mode, the screen display like fig2.











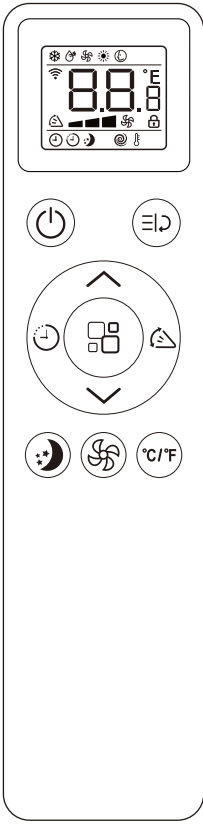

















SELF-DIAGNOSIS

The appliance has a self diagnosis system to identify a number of malfunctions.

Error messages are displayed on the appliance display.

IF IS DISPLAYED	WHAT SHOULD I DO?
<div style="text-align: center;">  <p>PF PROBE FAILURE (sensor damaged)</p> </div>	<p>If this is displayed, contact your local authorize service centre.</p>
<div style="text-align: center;">  <p>Ft FULL TANK (safety tank full)</p> </div>	<p>Empty the internal safety tank, following the instructions in the "End of season operations" paragraph.</p>

Remote Control

		Cooling mode		Fan speed
		Dry mode		Auto speed
		Fan mode		Child lock
		Heating mode		Timer on
		Smart mode		Timer off
		Signal		Sleep
		Display digits temperature or hours		Turbo
		°C or °F temperature		Follow me
		Swing		
		On/Off button		Function button
		Increase button		Mode button
		Decrease button		Swing button
		Timer button		Sleep button
		Unit Switch button		Fan speed button

√ Point the remote control at the receiver on the appliance.

√ The remote control must be no more than 7 meters away from the appliance (without obstacles between the remote control and the receiver).

√ The remote control must be handled with extreme care. Do not drop it or expose it to direct sunlight or sources of heat.

√ If the remote control do not work, please try to take out the battery, and put it back again.

INSERTING OR REPLACING THE BATTERIES

- Remove the cover on the rear of the remote control;
- Insert two "AAA" 1.5V batteries in the correct position (see instructions inside the battery compartment);
- Put the cover back to the remote control.

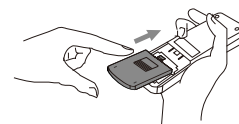
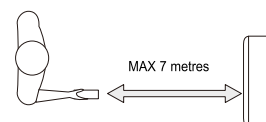





NOTE:

- √ If the remote control unit is replaced or disposed of, the batteries must be removed and discarded in accordance with current legislation as they are harmful to the environment.
- √ Do not mix old and new batteries. Do not mix alkaline, standard (carbon-zinc) or rechargeable (nickel-cadmium) batteries.
- √ Do not dispose of batteries in fire. Batteries may explode or leak.
- √ If the remote control is not be used for a certain length of time, remove the batteries.

COOL mode

Ideal for hot muggy weather when you need to cooling and dehumidify the room
To set this mode correctly:

- Press the  button a number of times until the  symbol appears.
- Select the target temperature 18°C-32°C (64°F-90°F) by pressing The  or  button until the corresponding value is displayed.
- Select the required fan speed by pressing the  button.

Three speeds are available: High / Low / Auto.

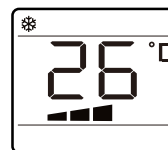

Low	High	Auto
		



The most suitable temperature for the room during the summer varies from 24°C to 27°C (75°F to 81°F). You are recommended, however, not to set a temperature much below the outdoor temperature. The fan speed difference is more noticeable when the appliance is under FAN mode but may not be noticeable under COOL mode.

FAN mode

When using the appliance in this mode, the air hose does not need to be attached.

- Press the  button a number of times until the  symbol appears
- Select the required fan speed by pressing the  button.

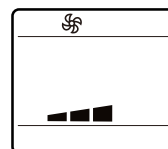

Three speeds are available: High / Low.



DRY mode



Ideal to reduce room humidity (spring and autumn, damp rooms rainy periods, etc).
In dry mode, the appliance should be prepared in the same way as for cool mode, with the air exhaust hose attached to enable the moisture to be discharged outside.

To set this mode correctly:

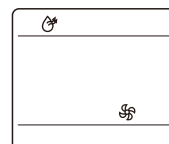
- Press the  button a number of times until the  symbol appears.
- In this mode, fan speed is selected automatically by the appliance and can not be set manually.



SMART mode

- Press the  button, a number of times until the  symbol appears.
- Select the required fan speed by pressing the  button.

Four speeds are available: High / Low / Auto.

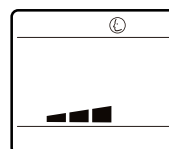

- If the appliance is cooling only model, the unit operates in Fan mode when the room temperature is below 23°C (73°F), and Cool mode when the room temperature is above 23°C(73°F).

- If the unit is cooling and heating model, the unit operates in Heat mode when the room temperature is below 20°C(68°F), and Fan mode when the room temperature is from 20°C (68°F) to 23°C(73°F), and Cool mode when the room temperature is above 23°C (73°F).

Display on the control panel:



The display will be running circulating.



SLEEP function

This function is useful for the night as it gradually reduces operation of the appliance.

To set this function correctly:

- Select the cool or heat mode as described above.
- Press the  button, and the  symbol appears.
- When you choose the sleep function, the screen will reduce the brightness, and the fan speed is low.



The SLEEP function maintains the room at optimum temperature without excessive fluctuations in either temperature or humidity with silent operation. Fan speed is always at Low, while room temperature and humidity vary gradually to ensure the most comfortable.

When in COOL mode, the selected temperature will increase by 1°C(1°F) per hour in a 2 hour period. This new temperature will be maintained for the next 6 hours. Then the appliance turn it off.

When in HEAT mode, the selected temperature will decrease by 1°C(1°F) per hour in a 3 hour period. This new temperature will be maintained for the next 5 hours. Then the appliance turn it off.

The SLEEP function can be canceled at any time during operation by pressing the "Sleep", "Mode" or "fan speed" button.

In DRY mode, SLEEP function is still available.

HEAT mode *

* * means only the heat pump model have this function.

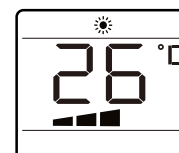

When choose the heat mode, appliance will turn to FAN mode.



SWING function

This function moves the deflectors to adjust the direction of the air flow.

To set this function correctly:

- Select the operating mode (cool, dry, fan) as described above.
- Press the  button to select the horizontal deflector to automatically move up and down.
- Press the  button again to switch off this function.



Switch the unit of temperature °C/°F

When the appliance is running, press the °C/°F button, then you can change the unit of temperature.

For example:

Before change, in cool mode, the screen display like fig1.

After change, in cool mode, the screen display like fig2.



fig1



fig2

SETTING THE TIMER

-This timer can be used to delay the appliance start-up or shutdown, this avoids wasting electricity by optimizing operating periods.

Programming start up











- Turn on the appliance, choose the mode you want, for example cool, 24°C/75°F, high fan speed. Turn off the appliance.
- Press the  button twice, the screen will display hours, the  symbol and  symbol are flashing .(fig 3)
- Press the  or  button until the corresponding time is displayed.
- Press the  button again, the timer will be active, the  symbol and  are displayed on screen.(fig 4)
- Press the  button again or the  button, the timer will be canceled, and the  symbol will disappear from screen.



fig 3

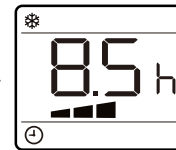













fig 4

Programming shut down

- When the appliance is running, press the  button, the screen will display hours, and the  symbol and  symbol are flashing.(fig 5)
- Press the  or  button until the corresponding time is displayed.
- Press the  button again, the timer will be active, the  symbol and  are displayed on screen.(fig 6)
- Press the  button again or the  button, the timer will be canceled, and the  symbol will disappear from screen.

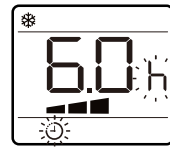

fig 5

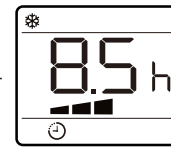

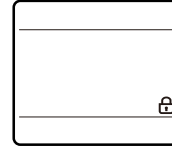

fig 6











CHILD LOCK function

This function is used to prevent children from pressing remote controller carelessly or accidentally.

- Hold down the  and  and press for more than 3 seconds to open or cancel the child lock function.
- When the child lock icon is on, pressing any button on the remote control will be invalid.







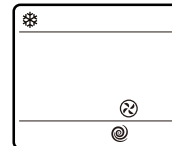

Turbo function

- Press the  button, the  symbol flash on screen,
- Press the  button again to confirm, the  will stop flash and show on screen, that the function is working.
- This function set the appliance directly to COOL mode with setting temperature 18°C(64°F) and High fan speed in order to reach low temperature in the shortest time.
- This function can not be set in Heat mode.
- To cancel this function, press the , the  flash on screen, and then press the  button again to confirm, the  will stop flash and disappear from screen.
- Press other button like “” or “” or “” also can cancel this function.







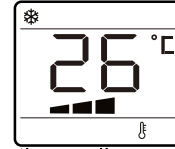

Follow me function

- This function can be activated from the remote control ONLY.
- The remote control serves as a remote thermostat allowing for the precise temperature control at its location.
- To activate the Follow Me function, point the remote control towards the appliance and press the  button, and then press  or  button to until the  flash on screen, and then press the  button again to confirm, the  will stop flash and show on screen.



The remote display is actual temperature at its location. The remote control will send this signal to the air conditioner every 20 minutes interval until press the Follow Me/Temp Sensing button again.

If the unit does not receive the Follow Me/Temp Sensing signal during any 25 minutes interval, the unit will exit the Follow Me/Temp Sensing mode.

To cancel this function, press the , and then press  or  button to until the  flash on screen, and then press the  button again to confirm, the  will stop flash and disappear from screen.

TIPS FOR CORRECT USE

To get the best from your appliance, follow these recommendations:

- Close the windows and doors in the room to be air conditioned (fig. 21). When installing the appliance semi-permanently, you should leave a door slightly open (as little as 1 cm) to guarantee correct ventilation;
- Protect the room from direct exposure to the sun by partially closing curtains and/or blinds to make the appliance much more economical to run (fig. 22);
- Never rest objects of any kind on the appliance;
- Do not block the air inlet or outlet of the appliance. Reduced air flow will result in poor performance and could damage the unit (fig. 23).
- Make sure there are no heat sources in the room;
- Never use the appliance in very damp rooms (laundries for example).
- Never use the appliance outdoors.
- Make sure the appliance is standing on a level surface. If necessary, place the castor locks under the front wheels.

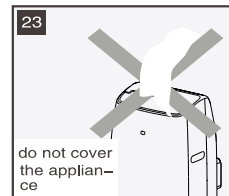
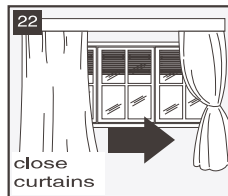
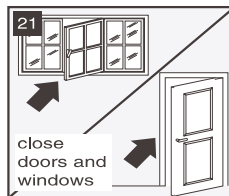

WATER DRAINAGE METHOD

When there is excess water condensation inside the unit, the appliance stops running and shows “FE” (FULL TANK as mentioned in SELF-DIAGNOSIE). This indicates that the water condensation needs to be drained using the following procedures:

Manual Draining (fig.24)

Water may need to be drained in high humidity areas

1. Unplug the unit from power source.
2. Place a drain pan under the lower drain plug. See diagram.
3. Remove the lower drain plug.
4. Water will drain out and collect in the drain pan (not supplied).
5. After the water is drained, replace the lower drain plug firmly.
6. Turn on the unit.

Continuous Draining (fig.25)

While using the unit in dehumidifier mode, continuous drainage is recommended.

1. Unplug the unit from the power source.
2. Remove the drain plug. While doing this operation some residual water may spill so please have a pan to collect the water.
3. Connect the drain hose (1/2" or 12.7mm, maybe not supplied). See diagram.
4. The water can be continuously drained through the hose into a floor drain or bucket.
5. Turn on the unit.

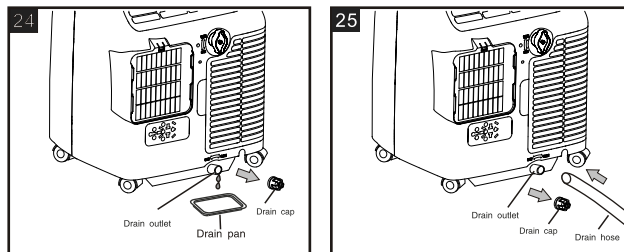

NOTE

Please be sure that the height of and section of the drain hose should not be higher than that of the drain outlet, or the water tank may not be drained. (fig.26 and fig.27)

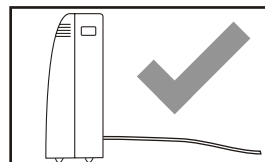

fig.26

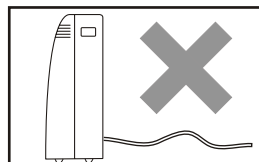
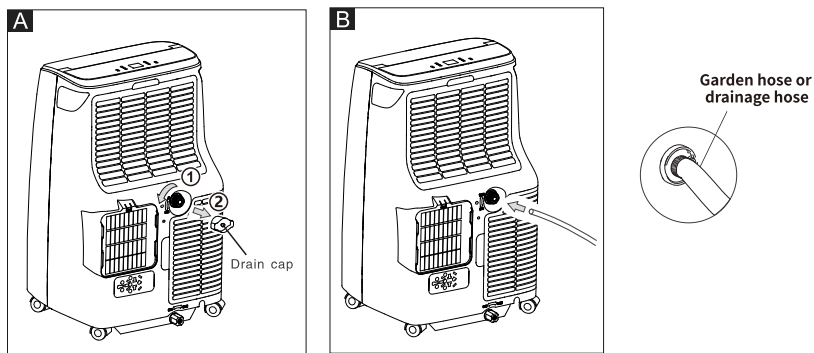

fig.27

Middle drainage

When unit running in Dry mode, you can choose the way below to drainage.

1. Unplug the unit from the power source.
2. Remove the drain plug (fig A). While doing this operation some residual water may spill so please have a pan to collect the water.
3. Connect the drain hose (1/2" or 12.7mm, maybe not supplied). (fig B)
4. The water can be continuously drained through the hose into a floor drain or bucket.
5. Turn on the unit.



NOTE

Please be sure that the height of and section of the drain hose should not be higher than that of the drain outlet, or the water tank may not be drained.

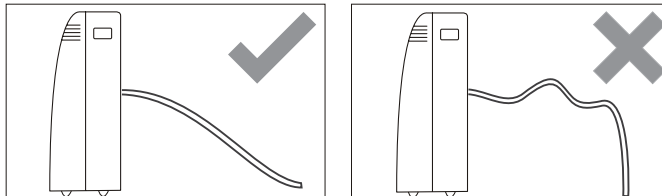

CLEANING

Before cleaning or maintenance, turn the appliance off by pressing the  button on the control panel or remote control, wait for a few minutes then unplug from the mains socket.

CLEANING THE CABINET

You should clean the appliance with a slightly damp cloth then dry with a dry cloth.

- Never wash the appliance with water. It could be dangerous.
- Never use petrol, alcohol or solvents to clean the appliance.
- Never spray insecticide liquids or similar.

CLEANING THE AIR FILTERS

To keep your appliance working efficiently, you should clean the filter every month of operation.

The filter can take out like fig below.

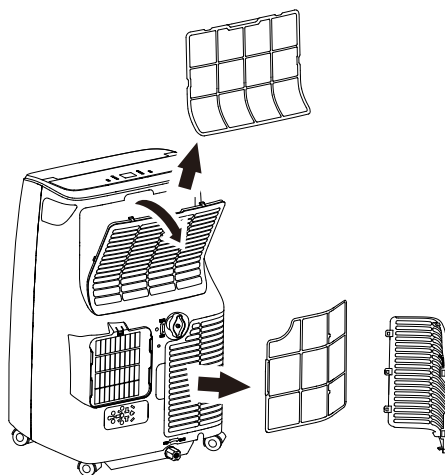

To avoid possible cuts, avoid contacting the metal parts of the appliance when removing or re-installing the filter. It can result in the risk of personal injury.

Use a vacuum cleaner to remove dust accumulations from the filter. If it is very dirty, immerse in warm water and rinse a number of times. The water should never be hotter than 40°C (104°F). After washing, leave the filter to dry then attach the intake grille to the appliance.

START-END OF SEASON OPERATIONS

START OF SEASON CHECKS

Make sure the power cable and plug are undamaged and the earth system is efficient.
Follow the installation instructions precisely.

END OF SEASON OPERATIONS

To empty the internal circuit completely of water, remove the cap.
Run off all water left into a basin. When all the water has been drained, put the cap back in place.
Clean the filter and dry thoroughly before putting back.

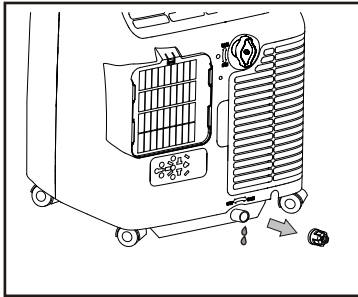

Strictest operation environment:

Cooling mode: 18°C-35°C (64°F-95°F)

Heating mode: 10°C-25°C (50°F-77°F)

Troubleshooting

Having trouble completing installation? Don't worry, it's usually an easy fix.

PROBLEM	POSSIBLE CAUSES	SOLUTIONS
Air Conditioner will not start	The air conditioner is unplugged	<ul style="list-style-type: none"> • Make sure the air conditioner plug is pushed completely into the outlet
	The fuse is blown/circuit breaker is tripped	<ul style="list-style-type: none"> • Check the house fuse/circuit breaker box and replace the fuse or reset the breaker
	Power Failure	<ul style="list-style-type: none"> • The unit will automatically re-start when power is restored • There is a protective time delay (approx. 3 minutes) to prevent damage to the compressor. For this reason, the unit may not start normal cooling for 3 minutes after it is turned back on.
	The current interrupter device is tripped	<ul style="list-style-type: none"> • Press the RESET button located on the power cord plug • If the RESET button will not stay engaged, discontinue use of the air conditioner and contact a qualified service technician
Air Conditioner does not cool as it should	Airflow is restricted	<ul style="list-style-type: none"> • Change to make sure there are no curtain blinds, or furniture blocking the air intakes of the air conditioner
	The temperature control may not be set correctly	<ul style="list-style-type: none"> • Lower the set thermostat temperature
	The air filter is dirty	<ul style="list-style-type: none"> • Clean the filter. See the Cleaning and Care Section of the manual
	The room may be too warm	<ul style="list-style-type: none"> • Please allow time for the room to cool down after turning on the air conditioner
	Cold air is escaping	<ul style="list-style-type: none"> • Check for open furnace registers and cold air returns
	The Cooling Coils are frozen	<ul style="list-style-type: none"> • See "Air Conditioner Freezing Up" below
	The air exhaust is detached from the appliance.	<ul style="list-style-type: none"> • Reattach the air exhaust hose to the back of the appliance.
Air Conditioner is freezing up	Ice blocks the air flow and stops the air conditioner from cooling the room	<ul style="list-style-type: none"> • Set the MODE to HIGH FAN or HIGH COOL and set the thermostat to a higher temperature
Poor heating or No heating (only for heating model)	When operating in very cold rooms, the appliance defreezes automatically, momentarily interrupting normal operation.	It is recommended to use heating mode in the temperature range of 55-70°F for better effect. In this mode, you may have to wait for a while before the appliance starts giving out hot air.

WARRANTY

Dear Customer

Thank you for your purchase and for your confidence in our company. This product meets applicable safety requirements and has undergone stringent testing during manufacturing process.

However, should there occur a defect, the product or its defective part(s) (excluding accessories and consumables) will be repaired free of charge (labour and parts) within a limited period. If you have any questions, please contact us, we will provide assistance as soon as possible.

Warranty period:

Labor: 12 Months from the Date of purchase.

Parts: 12 Months from the Date of purchase.

THIS LIMITED WARRANTY DOES NOT APPLY TO:

1. Damage caused by transportation or handling.
2. Damage caused to the product by accident, vermin, lightning, winds, fire, floods, or acts of God.
3. Damages caused by operating the product in a corrosive atmosphere.
4. Repairs when your DuraComfort product is used in other than normal, single-family household use or contrary to the instructions described in the product User's Guide.
5. Damage resulting from accident, alteration, misuse, abuse, or improper installation, repair, or maintenance. Improper repair includes the use of parts not approved or specified by DuraComfort.
6. Normal maintenance as described in the User's Guide, such as cleaning or replacing filters, cleaning coils, etc.
7. Use of accessories or components that are not compatible with this product.
8. Products with altered or removed serial numbers.
9. Changes in the appearance of the product that do not affect product performance.

HELP

Customer service: support@duracomfort-life.com

Shenzhen TCL Dura Electronic Technology Co., Ltd.

Room 11, 1st Floor, Block A, TCL Building, No.006, Gaoxin South 1st Road, Gaoxin Zone Community, Yuehai Subdi strict, Nanshan District, Shenzhen, Guangdong, China

Dura *Comfort*