

# *Comfort* **Dura** DEHUMIDIFIER

## INSTRUCTION USER'S MANUAL & Wi-Fi USER'S MANUAL

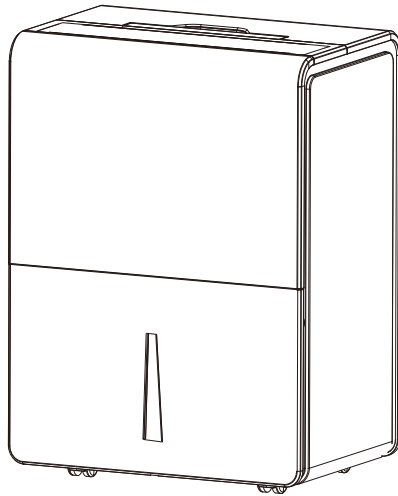

MODEL: DH25WM | DH35WM | DH50WM

Thank you for selecting our quality appliance. Please be sure to read this user manual carefully before using. Any question, please contact the professional service for help.

# Table of Contents

Warnings & Precautions -----	02
Parts and Features -----	04
Installation Guide -----	05
User Instruction -----	06
Troubleshooting -----	12
Error Code Chat -----	14
Recommend Humidity Level -----	14
Wi-Fi Connect user manual -----	15
Warranty -----	30

## Warnings & Precautions

When using electrical appliances, basic safety precautions should always be followed including the following:

### READ ALL INSTRUCTIONS BEFORE USE

1. To disconnect, turn off the unit and then unplug the power cord.
2. Close supervision is necessary if the appliance is used by or near children.
3. Do not attempt to repair or replace any part of this appliance unless it is specifically recommended in this manual. Contact dealer, seller, a qualified electrician, or an authorized service center to repair the product.
4. Do not immerse cord, plug, or the appliance in water or other liquid.
5. Do not operate any appliance with a damaged cord or plug or after the appliance malfunctions, or has been dropped or damaged in any manner. See warranty to return for examination, repair, or electrical or mechanical adjustment. Appliance serviced only by authorized agent.
6. The use of accessory attachments (not recommended or sold by the manufacturer) may cause fire, electric shock or injury.
7. Do not use outdoors.
9. Do not use appliance for anything other than intended use.
10. Always place this unit on a solid and level surface.
11. Do not cover the air inlet or vents.
12. Do not use extension cord. This appliance is for household use only.
13. This unit must be connected to a grounded power supply.
14. Do not place the appliance near any heat source.
15. Do not use this appliance near flammable gases or liquids or other combustibles.
16. Make sure the power cord is plugged firmly and completely into the outlet.
17. Be sure to remove all packaging material before using the appliance.
18. Immediately unplug the product if the appliance is making unusual sounds or is emitting smoke or odor.
19. Always turn off and unplug the appliance if not used for extended period of time.

### SAVE THESE INSTRUCTIONS

#### SOME NOTIONS ON HUMIDITY

Air always contains a certain amount of water in the form of vapour. This determines the level of humidity in an atmosphere. The capacity of the air to hold water vapour increases with temperature.

This is why in our homes, as soon as the temperature decreases, the vapour contained in the air condenses, as is evident on the colder surfaces in the room, such as the windows, walls etc. The purpose of a dehumidifier is to remove the excess moisture from the air, avoiding the damage caused by condensation.

Experts have established that the optimum environmental conditions for our well being and for the home are obtained between 40% and 60% relative humidity. With very low temperatures, you are recommended to heat the room even minimally. This considerably increases the dehumidifying power of the appliance. With heating, the condensation formed by the water vapour on windows and other cold surfaces evaporates into the air to be collected by the dehumidifier. Air leaving the dehumidifier is usually about 1°C-2°C warmer than room temperature.



CAN ICES-003(B)/NMB-003(B)  
ID : 2ANDL-TYWE1S IC : 23243-TYWE1S

**FCC Caution.**

This device complies with part 15 of the FCC Rules. Operation is subject to the following two conditions:

(1) This device may not cause harmful interference, and (2) this device must accept any interference received, including interference that may cause undesired operation.

Any Changes or modifications not expressly approved by the party responsible for compliance could void the user's authority to operate the equipment.

Note: This equipment has been tested and found to comply with the limits for a Class B digital device, pursuant to part 15 of the FCC Rules. These limits are designed to provide reasonable protection against harmful interference in a residential installation. This equipment generates uses and can radiate radio frequency energy and, if not installed and used in accordance with the instructions, may cause harmful interference to radio communications. However, there is no guarantee that interference will not occur in a particular installation. If this equipment does cause harmful interference to radio or television reception, which can be determined by turning the equipment off and on, the user is encouraged to try to correct the interference by one or more of the following measures:

- Reorient or relocate the receiving antenna.
- Increase the separation between the equipment and receiver.
- Connect the equipment into an outlet on a circuit different from that to which the receiver is connected.
- Consult the dealer or an experienced radio/TV technician for help.

The distance between user and device should be no less than 20cm.

**IC Warning**

This device complies with Industry Canada's licence-exempt RSSs. Operation is subject to the following two conditions:

(1) This device may not cause interference; and  
(2) This device must accept any interference, including interference that may cause undesired operation of the device.

This equipment complies with FCC radiation exposure limits set forth for an uncontrolled environment. This equipment should be installed and operated with minimum distance 20cm between the radiator & your body.

Cet appareil est conforme aux CNR exemptes de licence d'Industrie Canada . Son fonctionnement est soumis aux deux conditions suivantes :

- ( 1 ) Ce dispositif ne peut causer d'interférences ; et
- ( 2 ) Ce dispositif doit accepter toute interférence , y compris les interférences qui peuvent causer un mauvais fonctionnement de l'appareil.

Cet équipement est conforme aux limites d'exposition aux rayonnements IC établies pour un environnement non contrôlé. Cet équipement doit être installé et utilisé avec un minimum de 20 cm de distance entre la source de rayon

## Parts and Features

- |                            |                       |
|----------------------------|-----------------------|
| 1. Handle                  | 7. Drainage holes     |
| 2. Control panel           | 8. Hooks              |
| 3. Bucket                  | 9. Plug fixer         |
| 4. Water level view window | 10. Air outlet        |
| 5. Castors                 | 11. Air intake grille |
| 6. Power cord              | 12. Pump connector *  |

**Note:** “\*” means only for pump function model.

Smaller cabinet (Suitable for models up to 35 pints)

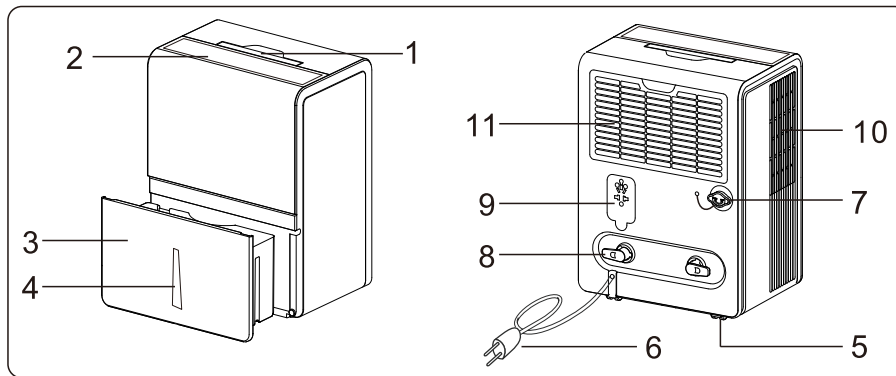

Bigger cabinet (Suitable for models over 50 pints)

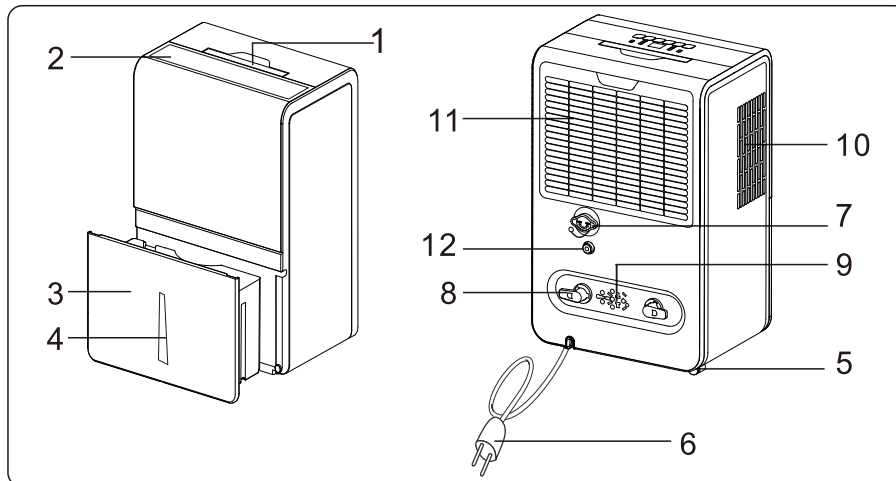

**Note:** All the illustrations in this manual are for explanatory purposes only. Your appliance may be slightly different. Be sure all accessories are removed from the packing and bucket before use.

## Installation Guide

Before use, please check the bucket whether some accessories in it.

- Remove the bucket, rotate the handle to the position like fig below.

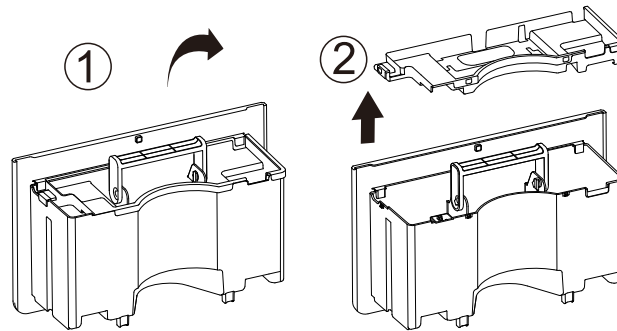

- Open the cover, take out of accessories in bucket.

- Re-install the cover and handle, correctly put back the bucket into the unit.

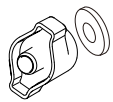

### Accessories:

Smaller cabinet (Suitable for models up to 35 pints)

	Drainage connector	1 set	Supply for whitout pump model appliance
	Drain pipe	1 set	Supply for whitout pump model appliance

Bigger cabinet (Suitable for models over 50 pints)

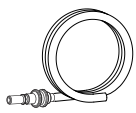
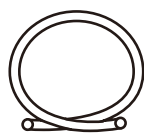
	Pump drain pipe (about 5m, 16.4 ft)	1 set	Only supply for pump model appliance.
	Drain pipe	1 set	Supply for whitout pump model appliance

## User Instruction

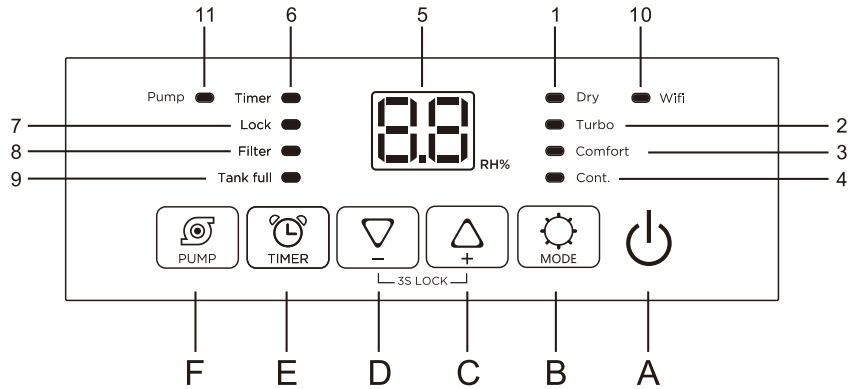

- |                    |                      |                        |
|--------------------|----------------------|------------------------|
| A. On/Off button   | 1. Dry symbol        | 6. Timer symbol        |
| B. Mode button     | 2. Turbo symbol      | 7. Child lock symbol   |
| C. Increase button | 3. Comfort symbol    | 8. Clean filter symbol |
| D. Decrease button | 4. Continuous symbol | 9. Bucket Full Alarm   |
| E. Timer button    | 5. LED screen        | 10. Wi-Fi symbol *     |
| F. Pump button     |                      | 11. Pump symbol **     |

Note: \*The WIFI is an optional function.

When the unit is connected with phone, the WIFI symbol is light on, and how to connected with phone, please see the Wi-Fi manual.

**\*\* Pump (Some special model have this function)**

Note: All the illustrations in this manual are for explanatory purposes only. Your appliance may be slightly different. Be sure all accessories are removed from the packing and bucket before use.

Insert the plug in the socket, the unit goes to stand-by, and the screen display as the fig shown:



### ● " (⏻) " button

- On / off power supply, used to control the start-up or shut down the appliance.

### ● Pre-set mode

Pre-set mode allow the user to easily move the appliance room-to-room and select the corresponding mode for the location in which the appliance operating for optimum performance. Press the "MODE" button to choose from Dry, Turbo, Comfort or Continuous.

#### \* Dry mode

Press the "MODE" button until the "Dry" symbol is lights.



Press the "▽" or "△" to choose the humidity desired, adjustable range is 35%RH-80%RH.

The fan speed is low and cannot be adjusted.

The screen will display the setting humidity, and after 2 seconds, turn to display the ambient humidity.

## User Instruction

### \* Turbo mode

Press the "  " button until the " Turbo " indicator is lights, the setting humidity is 35%RH, press the "  " or "  " to choose the humidity desired.

The fan speed is high and can not be adjusted.

The screen will display the setting humidity, and after 2 seconds, turn to display the ambient humidity.

### \* Comfort mode

Press the "  " button until the " Comfort " indicator is lights, the appliance will setting humidity according the ambient temperature. So the humidity can not be adjusted.

The fan speed is low and can not be adjusted.

The screen will display the ambient humidity, and after 1 minute the screen light will go to dim , another 1 minute later the screen will turn off.

Press the "  " button to quit the Comfort mode, and press other button to check the status, the screen will light again.

### \* Continuous mode

Press the "  " button until the " Cont. " indicator is lights, the setting humidity is 15%RH and can not be adjusted, the unit will continuously run.

The fan speed is low and can not be adjusted.

### ● Decrease / Increase button



- Press "  " / "  " to select the indoor humidity level you expect to achieve, or set the time.

- Humidity adjustable range is 35%RH-80%RH. The screen will display the setting humidity, and after few seconds, turn to display the ambient humidity.

- When the ambient humidity lower than setting humidity, the compressor stop running, and after few minutes the fan stop running.

### ● Child lock

Locking the control panel prevents someone from accidentally changing the settings.

- To lock the control panel, hold the "  " and "  " button 3 seconds. When locked, the "LOCK" symbol will light up.



- Hold the "  " and "  " button 3 seconds to unlock the control panel, and the "LOCK" symbol will disappear.

### ● Timer button

This timer can be used to delay the appliance start-up or shutdown, this avoids wasting electricity by optimizing operating periods.

#### Programming start-up



- Turn on the appliance, choose the mode you want, for example Dehumidify mode, 65%RH. Turn off the appliance.

- Press the "  " button , the screen starts to flash, press the "  " or "  " to adjust the set time from 0.5-24 hours.

- In 5 seconds without the operation, the timer start function, then the "Timer" symbol lights.

- Press the "  " button again to cancel the Timer, and the "Timer" symbol disappear.

#### Programming shut down

- When the appliance is running, press the "  " button, the screen starts to flash, press the "  " or "  " to adjust the set time from 0.5-24 hours.

- In 5 seconds without the operation, the timer start function, then the "Timer" symbol lights.

- Press the "  " button again to cancel the Timer, and the "Timer" symbol disappear.



## User Instruction

### \* Clean filter

- When the filter needs to be cleaned, the "Filter" symbol will light up(after 250 hours of use). Remove the filter from the back of unit follow the "CLEAN THE FILTER" chapters.

- Once the filter is completely dry, place filter back in the unit and hold the "TIMER" button 3 second to reset the time and the "Filter" symbol is turn off.

Caution: Do not operate the appliance without the included filter.

### \* Pump drain (Some special model have this function)

Connect the pump drain pipe(5m or 16.4ft) on the back of unit, then the unit can continuous run without clean the bucket.

- 1) Put the unit on level floor;
- 2) Install the drain pipe on connector;
- 3) Press " (I) " button to run the unit, press the "PUMP" button start the pump drain function, and the "PUMP" symbol is light up.
- 4) The max. height of pump drainage is about 5 meters(16.4 ft).

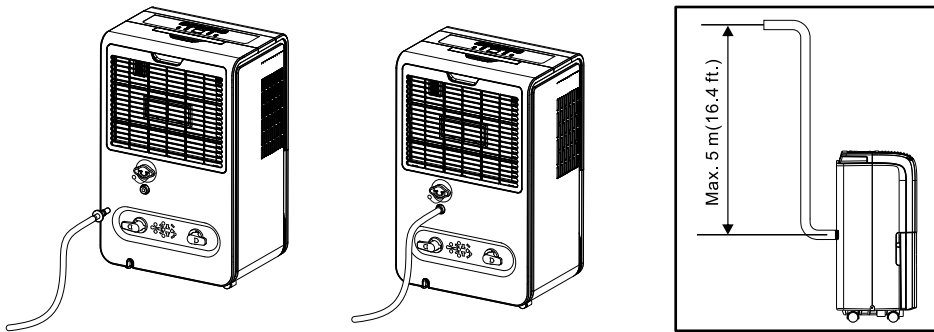

Note:After pump button has been activated, pump will not begin removing water, the pump will remain on stand-by. When bucket is almost full, pump will automatically begin removing water and stop when pump work 4 min. This cycle will continue until pump button is deactivated. Make sure there are no kinks or knots in the hose.



### WARNING:

Before the ambient temperature drops to 0°C (32°F), the condensate remaining in the appliance must be emptied to avoid damage to the machine.

Follow next step to emptied the condensate:

- 1) Take out the bucket.
- 2) Find the drainage port.
- 3) Remove the cover and plug to drainage water.
- 4) Install back the cover and plug on appliance.
- 5) Pull back the bucket.

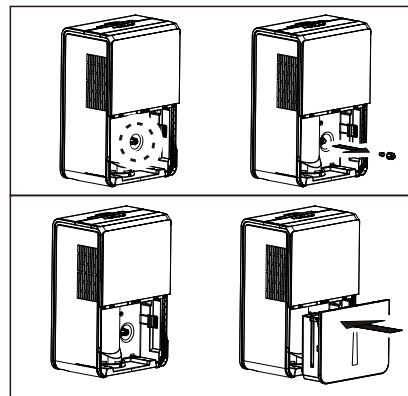

## User Instruction

### \* Alarm of bucket full

- When bucket is full, the compressor will shut off, the fan will stop for a few minutes, and make a beeping noise, "Tank Full" symbol is flashing.
- The unit will not run again until the bucket is emptied and properly placed back inside the unit.
- The bucket should be cleaned every week to prevent the growth of mold, mildew and bacteria. Use a mild detergent to clean. Once clean, completely dry the bucket and place it back inside unit.

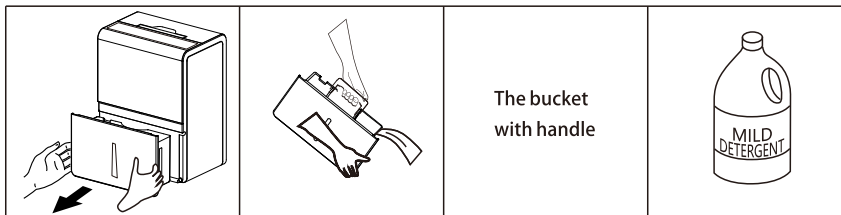

Note: Hold the bucket with both hands when emptying.

Note: When the bucket is full or removed from the unit, the compressor will turn off but the fan will continue to run for a few minutes. This is completely normal. The unit will not be removing moisture from the air at this time.

Note: During operation, it is normal for the unit to exhaust warm air from the top of the unit.

Caution: Do not place the bucket on the floor when it is full as it is uneven on the bottom and water may spill.

### \* Continuous drain

Connect the drain pipe on the back of unit, then the unit can continuous run without clean the bucket.

- 1) Put the unit on level floor, unscrew the cap on the back of unit;
- 2) Install the garden hose(which has an outer diameter of 1 1/16 inches, or 1.0625 inches or 27.0mm, and a pitch of 11.5 TPI) on unit;
- 3) Press "⏸" button to run the unit.

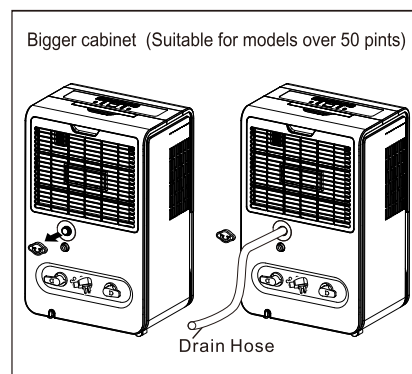
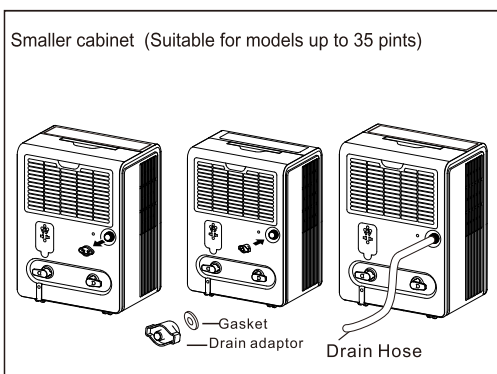

## User Instruction

Note: Please install the drain pipe follow below picture.

Please install the drain pipe correctly, or the water cannot drain from the pipe.

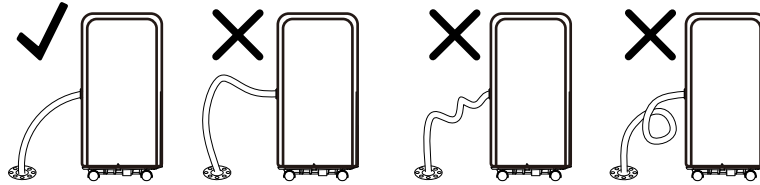

Notice: If the unit put on the un-level ground or not correctly install the drain pipe, the water will full the bucket and stop run. If that happened, please check the ground is whether horizon, and the drain pipe is correctly installed. At the same time, the bucket need to be install correctly.

### \* AUTOMATIC DEFROST

When frost builds up on the evaporator coils, the compressor will cycle off and the fan will continue to run until the frost disappears. When the coils are completely defrosted, the compressor or fan (depending on the model) will automatically restart and dehumidify will resume.

### Location requirements:

The unit operating in a basement will have little no effect in drying out an adjacent enclosed storage area, such as a closet, unless there is adequate circulation of air in and out of the area.

1. Do not use outdoors.
  2. This appliance is intended for indoor use only. Place the appliance on a smooth, level floor surface that is strong enough to support the unit with a full bucket of water.
  3. Allow at least 18"(45cm) of around and above space away from the wall for efficient working.
  4. Place the appliance in an area where the temperature will not fall 5°C (41°F).
  5. Use the dehumidifier in cooking, laundry, bathing and dish-washing areas that have excessive moisture.
  6. Place the dehumidifier away from a clothes dryer.
  7. Use the dehumidifier in a basement to help prevent moisture damage.
  8. The dehumidifier must be operated in an enclosed area to be most effective, close all doors, windows and other outside openings to the room.
  9. Do not block the air inlet or outlet of the appliance.
- Reduced air flow will result in poor performance and could damage the unit.

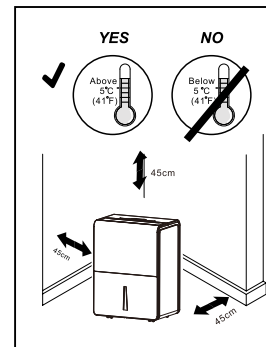

## User Instruction

### CLEAN AND MAINTENANCE

Before cleaning or maintenance, turn the appliance off by pressing the "POWER" button on the control panel, wait for a few minutes then unplug from the mains socket.

### CLEANING THE CABINET

You should clean the appliance with a slightly damp cloth then dry with a dry cloth.

- Never wash the appliance with water, it could be dangerous.
- Never use petrol, alcohol or solvents to clean the appliance.
- Never spray insecticide liquids or similar.

### CLEANING THE FILTER

● If the filter is dirty, air circulation is compromised and the efficiency of the dehumidifying and air purifying functions decreases. It is therefore good practice to clean the filter at regular intervals. The frequency depends on the duration and conditions of operation. If the unit is used constantly or systematically, you are recommended to clean the filter once a month.

- The filter can take out like fig.
- To avoid possible cuts, avoid contacting the metal parts of the appliance when removing or re-installing the filter. It can result in the risk of personal injury.
- Use a vacuum cleaner to remove dust accumulations from the filter. If it is very dirty, immerse in warm water and rinse a number of times. The water should never be hotter than 40°C (104°F). After washing, leave the filter to dry then attach the intake grille to the appliance.

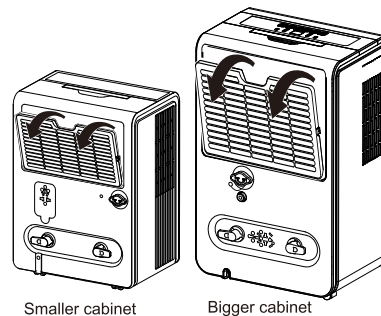

### END OF SEASON OPERATIONS

- To unplug from the mains socket, empty the bucket, remove the cap.
- Run off all water left inside the appliance. When all the water has been drained, put the cap back in place.
- Clean the filter and dry thoroughly before putting back.
- Cover the appliance prevent from dust.
- Store the appliance upright in a dry location.
- The power cord can winding in the wire hook, and then put the plug into the storage hole.

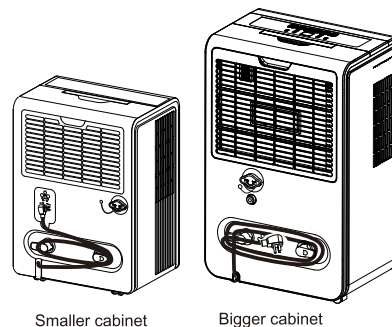

### START OF SEASON CHECKS

Make sure the power cable and plug are undamaged and the earth system is efficient.

Follow the installation instructions precisely.

## Troubleshooting

Occasionally, you may encounter some problems that are of a minor nature and a service call may not be necessary. Use this troubleshooting guide to identify possible problems you may be experiencing.

Problem	Possible Causes	Solutions
Dehumidifier does not start	The dehumidifier is unplugged.	Make sure the dehumidifier's plug is pushed completely into the outlet.
	The fuse is blown/circuit breaker is tripped.	Check the house fuse/circuit breaker box and replace fuse or reset breaker.
	Dehumidifier has reached its present level or the bucket is full.	The dehumidifier automatically turns off when either condition occurs. Change to a lower setting or empty the water bucket and replace properly.
	Bucket is not in the proper position.	The bucket must be in place and securely seated for the dehumidifier to operate.
	Power Failure	There is a protective time delay (up to 3 min.) to prevent trip-ping of the compressor overload. For this reason, the unit may not start normal dehumidify for 3 min after it is powered back on.
Dehumidifier does not dry the air as it should	Not enough time allowed for unit to remove moisture	When first installed, allow at least 24 hours to maintain the desired dryness.
	Airflow is restricted	Make sure there are no curtains, blinds, or furniture blocking the front or back of the dehumidifier. See the CHOOSING A LOCATION section.
	Dirty filter	See the CLEAN FILTER section.

## TroubleShooting

Problem	Possible Causes	Solutions
Dehumidifier does not dry the air as it should	The Humidity Control may not be set low enough	For drier air, press the ▾ button to lower the percent humidity desired in the room, or set the dehumidifier to "Cont." mode for maximum dehumidify.
	Doors and windows may not be closed tightly	Check that all doors, windows, and other openings are securely closed.
	Clothes dryer may be blowing moist air into the room	Install the dehumidifier away from the dryer. The dryer should be vented outside.
	Room temperature is too low	Moisture removal is best at higher room temperatures. Lower room temperatures will reduce the moisture removal rate. This model is designed to operate at temperatures above 5°C (41°F).
Appliance runs too long	The area is too large	The capacity of the appliance can not meet the area of the room.
	Doors and windows are open	Close the door and window.
Frost appears on heat-exchanger	Appliance run recently or the room temperature is too low	It is normal, frost usually disappear in 60 min.
Fan noise	The air is passing through the appliance	This is normal.
Water on the floor	The drain connection may be aging or loose	Check the drain connection and the appliance is placed level.
	The drain pipe is connected, but the water is not drained	If use the bucket, remove the drain pipe and put back the drain cover; or install the drain pipe correctly.

## Error Code Chat

If the following error code appears, please check the causes and solution.

CODE	DESCRIPTION	POSSIBLE CAUSES	SOLUTIONS
EH	Humidity sensor failure	Humidity sensor is damaged.	Connect customer service center.
E1	Temperature sensor failure	Temperature sensor is damaged.	Connect customer service center.
E2			
E3	Gas leakage	Ambient temperature is too high.	Move the appliance to cooler place.
		E3 appears many times.	Connect customer service center.
E5	Pump failure	Didn't install the pump drainage kit before start pump function.	Install the pump drainage kit, before start pump function.
		Users use non-standard drainage pipes. (Manufacturer's original pipe)	Use the original pipe.
		The drain cover is not tightened.	Tighten the cover.
		The rubber washer is missing.	Re-install the washer in cover.
		Poor connection between drain pipe and drain cover.	Check the connection of pipe and drain cover.

Note:

1.The code "E5" is only for pump model, others model appliance have not these two codes.

2.If E3 appears,please the check the ambient temperature range whether below 32 °C.

If the ambient temperature over 32 °C, place the unit into the place below 32 °C (suggest 30°C) for two hours before running the air conditioner again.

Star-up the unit, if the E3 appears again in 2 hours, please contact the service center.

Strictest operation environment: 5°C~32°C (41°F~90°F) ,30%RH~90%RH.

## Recommend Humidity Level

Spring / Summer	30% - 50%
Fall / Winter	30% - 40%

**Dura** *Comfort*

## DEHUMIDIFIER

### Wi-Fi Connect User Manual



**Note: Only for dehumidifier**

This description is applied to appliance with Wi-Fi function. Please read the manual carefully before using the product and keep it for future reference.

---

**⚠ CAUTION! WARNING:** Do not use this device before reading these instructions.



## Let's get start!

Operation guideline. Please take below simple guideline instruction as reference.

Operation Steps	Operation Items	New Account	Re-install APP (registered before)
Step 1	Download and Install APP	YES	YES
Step 2	Active APP	YES	YES
Step 3	Registration Account	YES	NO
Step 4	Login	YES	YES
Step 5	Add Device to control	YES	Registered Device will remain.

### FCC Caution (FCC ID: 2AJCLTWAC-TYWFS)



This device complies with part 15 of the FCC Rules. Operation is subject to the following two conditions: (1) This device may not cause harmful interference, and (2) this device must accept any interference received, including interference that may cause undesired operation.

Any Changes or modifications not expressly approved by the party responsible for compliance could void the user's authority to operate the equipment.

Note: This equipment has been tested and found to comply with the limits for a Class B digital device, pursuant to part 15 of the FCC Rules. These limits are designed to provide reasonable protection against harmful interference in a residential installation. This equipment generates uses and can radiate radio frequency energy and, if not installed and used in accordance with the instructions, may cause harmful interference to radio communications. However, there is no guarantee that interference will not occur in a particular installation. If this equipment does cause harmful interference to radio or television reception, which can be determined by turning the equipment off and on, the user is encouraged to try to correct the interference by one or more of the following measures:

- Reorient or relocate the receiving antenna.
- Increase the separation between the equipment and receiver.
- Connect the equipment into an outlet on a circuit different from that to which the receiver is connected.
- Consult the dealer or an experienced radio/TV technician for help.

The distance between user and device should be no less than 20cm.

- If the appliance have the Wi-Fi function , the transmission power: less than 20dBm, and the radio frequency range is: 2412MHz - 2472MHz.
- The appliance is compliant with the RE Directive (2014/53/EU).

## Wi-Fi Module specification and basic information

1. **Minimum specifications on a Smart phone:**

Android 5.0 version or higher

IOS 10.0 version or higher

2. **Basic parameters for Wi-Fi:**

Parameters	Details
Network frequency	2.400 - 2.500GHz
Standards of WLAN	IEEE 802.11 b/g/n(channels 1-14)

## Download and Install the App

Method1: Please scan the QR code with a browser scanner, download and install the APP.



iOS



Android



SmartLife-SmartHome

Method2:

For Android smart phone, open the Google "Play Store" on your smart phone and search "SmartLife -SmartHome", download and install the APP.



For IOS smart phone, open the Apple "App Store" on your smart phone and search " SmartLife -SmartHome ", download and install the APP.



 **Note:**

**Please enable the permissions of Storage / Location / Camera / Wi-Fi / Bluetooth for this APP when installing. Otherwise it will have some problems when operating.**

## Active App

1. When you first time enter the APP, it will display activation interface, you can select activation QR code (click "Scan" button and scan the activation QR code in below page) or input "activation code" words (in below page), click "activate" button to active it

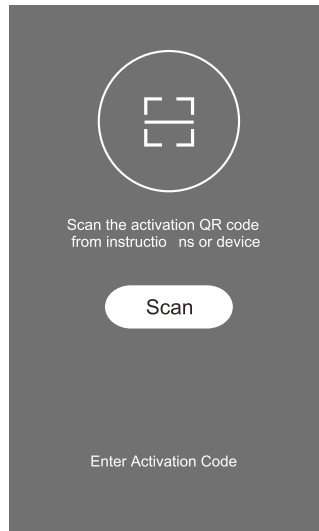

2. Activation QR code

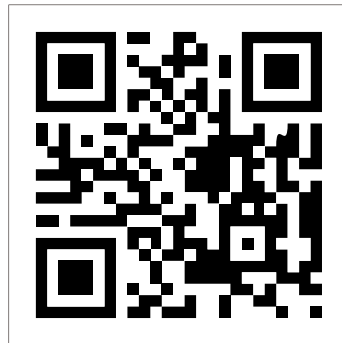

3. Activation code WORDS:     DuraComfort

## Registration

- 1.If you don't have any account please tap button "Register".
- 2.Read the "Privacy Policy" and tap "Agree".

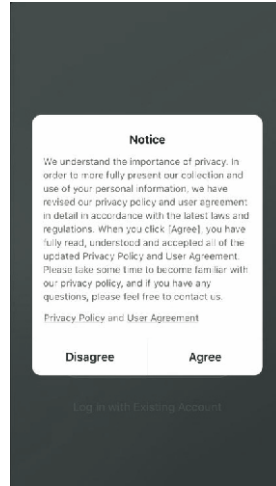
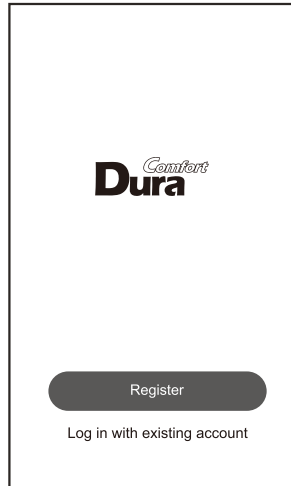

- 3.Tap " > " and choose the country.

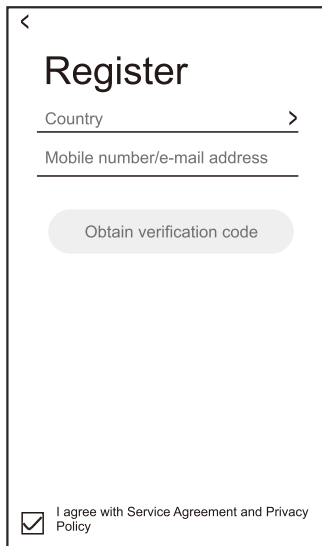

Search the country or slide the screen up/down to find and choose the country.

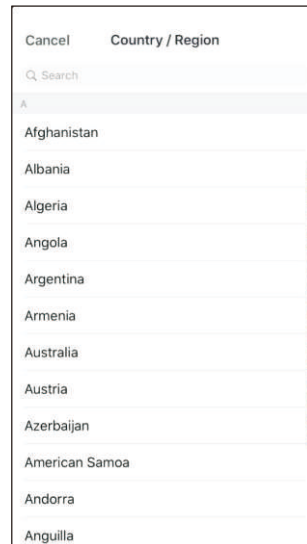

## Registration

4. Enter your E-mail address.

5. Tap the button "Get Verification Code".

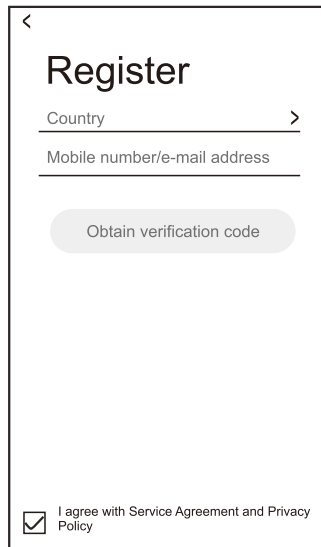

A screenshot of a mobile application's registration screen. At the top left is a back arrow. The title "Register" is centered. Below it are two input fields: "Country" with a right-pointing chevron and "Mobile number/e-mail address". A rounded button labeled "Obtain verification code" is centered below the fields. At the bottom left is a checked checkbox, and to its right is the text "I agree with Service Agreement and Privacy Policy".

6. Enter the verification code you received from E-mail.

7. Set the Password with 6-20 characters including characters and numbers.

8. Tap "Done".

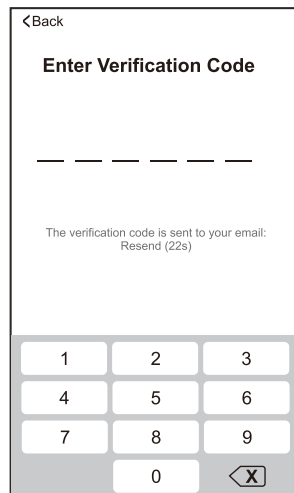

A screenshot of the "Enter Verification Code" screen. It has a back arrow at the top left. The title "Enter Verification Code" is centered. Below the title is a dashed line representing the input field. Underneath, it says "The verification code is sent to your email:" followed by a "Resend (22s)" link. At the bottom is a numeric keypad with digits 1-9, 0, and a back arrow with an 'X'.



A screenshot of the "Set Password" screen. It has a back arrow at the top left. The title "Set Password" is centered. Below the title is a password input field with six dots and a right-pointing chevron. A rounded button labeled "Done" is centered below the field.

## Log in

- 1.If you already have account, tap "Log in with Existing Account".
- 2.Enter your registered account and password.
- 3.Tap "Log in" button.

The image displays two screenshots of the Dura Comfort app interface. The left screenshot shows the main screen with the 'Dura Comfort' logo and a 'Register' button. The right screenshot shows the 'Login' screen with input fields for Country, Mobile number/e-mail address, and Password, a 'Log in' button, and a checkbox for 'I agree with Service Agreement and Privacy Policy'.

## Log in

Forgot the password

If you forgot the password or you want to reset the password, operate as below:

1. Tap "Forgot password".
2. Enter your account (E-mail address) and tap button "Get verification code".
3. Enter the verification code received by your E-mail.
4. Set the new password and tap button "Done".

The image displays three sequential mobile application screens for password recovery:

- Screen 1: Login**
  - Header: <Back
  - Title: Login
  - Fields: Country (with a right arrow), Mobile number/e-mail address, Password.
  - Button: Log in
  - Links: SMS verify and sign in, Forgot password
  - Footer:  I agree with Service Agreement and Privacy Policy
- Screen 2: Enter Verification Code**
  - Header: <Back
  - Title: Enter Verification Code
  - Field: A dashed line indicating where to enter the code.
  - Text: The verification code is sent to your email: Resend (22s)
  - Keypad: A numeric keypad with buttons for 1-9, 0, and a back arrow with an 'X'.
- Screen 3: Set Password**
  - Header: <Back
  - Title: Set Password
  - Field: A password input field with a strength indicator (six dots) and a clear 'X' button.
  - Button: Done



## Add device

There are 2 methods to add the device.

CF mode can connect one or more devices at the same time, AP mode can connect one device every time. The original mode is CF mode. It is recommended to use CF mode to connect.

Please **power on** the appliance, but **do not press the “” button** to turn on it. And the screen show:



### 1- Plug into the mains socket

When plug into the mains socket, the display screen will show the “CF”, and follow the CF mode to connect.

### 2-CF mode

2.1 Click "" in the upper right corner of the "Home" screen or tap "Add device" on the room which has no device.

2.2 Tap the "Dehumidifier" logo

2.3 Input the password of the Wi-Fi which the same as your smart phone connected, then tap "Next".

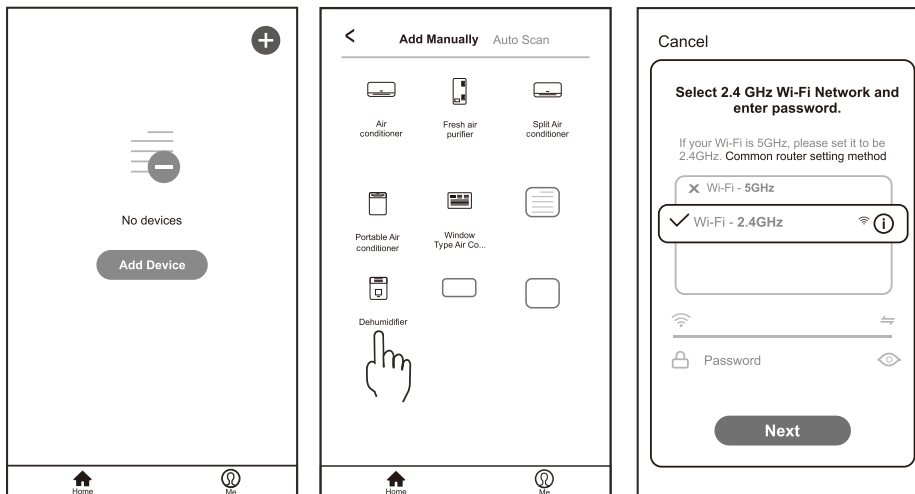

**Note:** Please make sure the “Password” is correct, or the connect will be failure.

2.4 Click "⇌" in the upper right corner and select the "CF Mode" or "EZmode", and tap "Next".

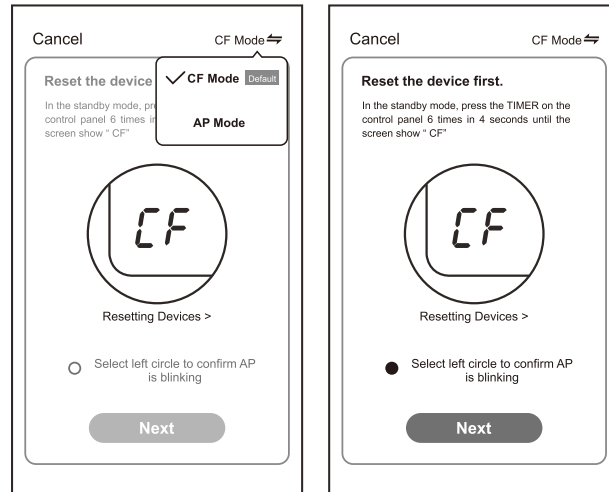

2.5 You can see the percent rate of connecting process, at the same time "PP", "SA", "AP" shining in turn on the appliances display.

"PP" means "Searching the router"

"SA" means "connected to the router"

"AP" means "connected to the server"

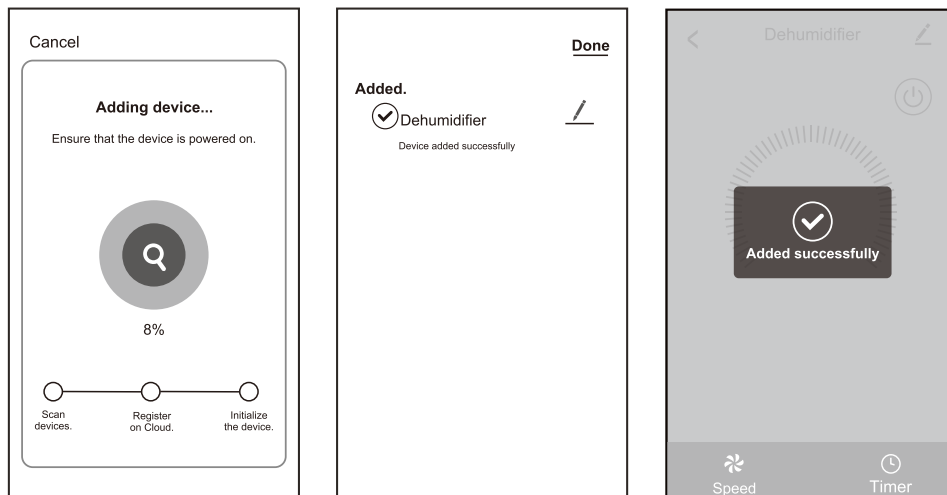

2.6 If connect Wi-Fi failure, please try to reset WIFI module and connect it again.

#### 2.6.1 Reset method

There are two methods to reset the WIFI module

A: Press the "TIMER" button on the control panel 6 times within 4 seconds;

B: Hold the "ON/OFF" button on the control panel about 5 seconds.

Please wait about 10 seconds, until the LED screen show "CF", and connect it again.

Note: Every time reset the Wi-Fi, must wait about 10 seconds, then the screen will display "CF" or "AP" 5 times.

Note: There will be switch between "CF" and "AP" mode if reset the WIFI module.

## Add device

### 3-AP mode

Note: The original state of the newly bought unit is in CF mode. If you choose to use AP mode, Please reset the Wi-Fi module and wait about 10 seconds until the LED screen show "AP", then start to connect it.

3.1 Click "+" in the upper right corner of the "Home" screen or tap "Add device" on the room which has no device.

3.2 Tap the "Dehumidifier" logo

3.3 Input the password of the Wi-Fi which the same as your smart phone connected, then tap "Next".

**Note: Please make sure the "Password" is correct, or the connect will be failure.**

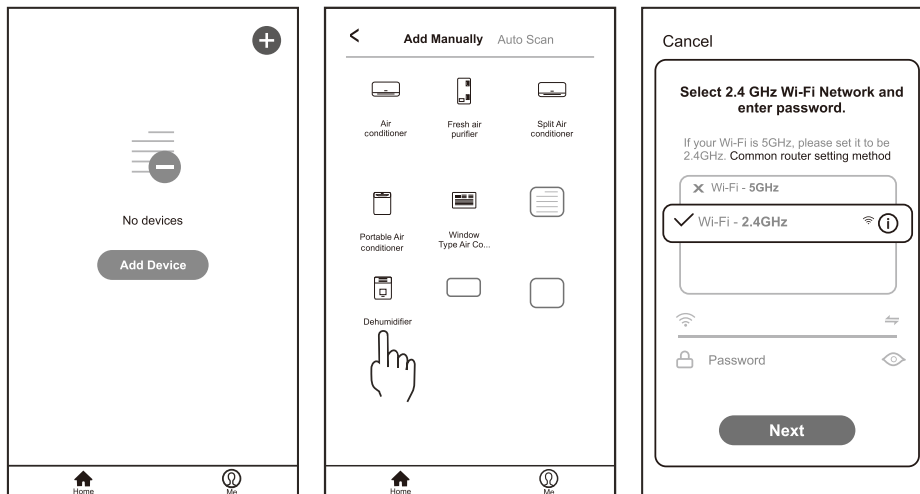

3.4 Power on the appliances, no need to launch the appliances. Follow the comments on the next screen, Click "↔" in the upper right corner and select the "AP Mode", then check "Select circle to confirm the AP is blinking" and tap "Next".

3.5 Select the device as name "Smartlife-XXXX" at the WLAN setting, then back to the APP interface, The APP will automatically do match.

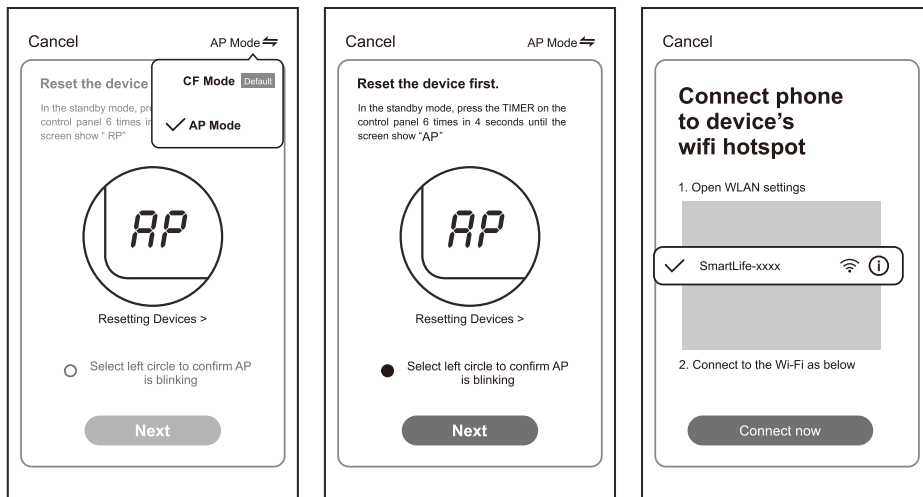

3.6 You can see the percent rate of connecting process, at the same time "PP", "SA", "AP" shining in turn on the appliances display.

- "PP" means "Searching the router"
- "SA" means "connected to the router"
- "AP" means "connected to the server"

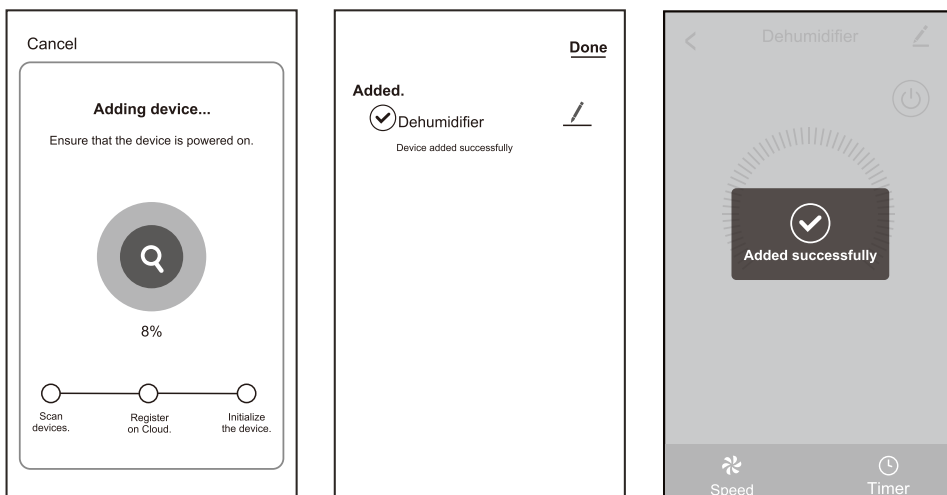

3.7 If connect Wi-Fi failure, please try to reset WIFI module and connect it again.

1.6.1 Reset method

There are two methods to reset the WIFI module

A: Press the "TIMER" button on the control panel 6 times within 4 seconds;

B: Hold the "ON/OFF" button on the control panel about 5 seconds.

Please wait about 10 seconds, until the LED screen show "CF", and connect it again.

Note: Every time reset the Wi-Fi, must wait about 10 seconds, then the screen will display "CF" or "AP" 5 times.

Note: There will be switch between "CF" and "AP" mode if reset the WIFI module.

**Pairing Process**

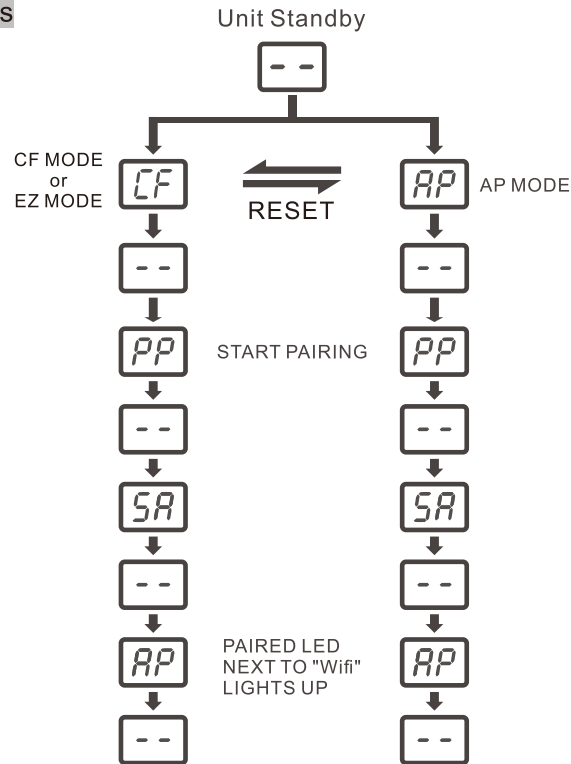

<i>CF</i>	Waiting pair after reset
<i>AP</i>	1) Hotspot connect mode 2) Access to the Internet
<i>PP</i>	Searching and try to connect
<i>SA</i>	Connect successful

## Trouble Shooting

Description	Analysis of cause
<p><b>Appliance can't be configured successfully</b></p>	<p>1. Please enable the permissions of Storage / Location / Camera / Wi-Fi / Bluetooth for this APP when installing. Otherwise it will have some problems when operating.</p> <p>2. Check the mobile connected WLAN router SSID and password is correct;</p> <p>3. Check whether there are additional settings of WLAN router as shown below.</p> <p>1) Firewall by router itself or by PC 2) MAC address filtering 3) Hidden SSID 4) DHCP server</p> <p>Reboot WLAN router, mobile device and appliance (WLAN module) and connect appliance by CF or AP mode again. Before rebooting, check nobody has already connected to same appliance.</p>
<p><b>Mobile can't control appliance</b></p>	<p>1. When appliance (WLAN module) is rebooted and app displays device remove, ignoring this confirmation will lead to mobile device losing control permission of the appliance. You will need to connect the appliance by CF mode again.</p> <p>2. In case of power failure, mobile device will lose control permission of appliance for 3 minutes after power failure. (Notification will now show up on the mobile device.)</p> <p>If you cannot control the app (appliance) even after power restored, you will need to connect the appliance by CF mode again.</p>
<p><b>Mobile can't find appliance</b></p>	<p>1. App display appliance Device offline. Please check the following conditions.</p> <p>1) The appliance has been reconfigured. 2) Appliance out of power. 3) Router out of power. 4) Appliance can't connect to router. 5) Appliance can't connect to network through the router. 6) Mobile device can't connect to network.</p> <p>2. After adding the device, it disappears in device list .</p> <p>Hold and slide down to refresh the device list. If it has no change, shut down the app and start again.</p>

# WARRANTY

## Dear Customer

Thank you for your purchase and for your confidence in our company. This product meets applicable safety requirements and has undergone stringent testing during manufacturing process.

However, should there occur a defect, the product or its defective part(s) (excluding accessories and consumables) will be repaired free of charge (labour and parts) within a limited period. If you have any questions, please contact us, we will provide assistance as soon as possible.

## Warranty period:

Labor: 12 Months from the Date of purchase.

Parts: 12 Months from the Date of purchase.

## THIS LIMITED WARRANTY DOES NOT APPLY TO:

1. Damage caused by transportation or handling.
2. Damage caused to the product by accident, vermin, lightning, winds, fire, floods, or acts of God.
3. Damages caused by operating the product in a corrosive atmosphere.
4. Repairs when your DuraComfort product is used in other than normal, single-family household use or contrary to the instructions described in the product User's Guide.
5. Damage resulting from accident, alteration, misuse, abuse, or improper installation, repair, or maintenance. Improper repair includes the use of parts not approved or specified by DuraComfort.
6. Normal maintenance as described in the User's Guide, such as cleaning or replacing filters, cleaning coils, etc.
7. Use of accessories or components that are not compatible with this product.
8. Products with altered or removed serial numbers.
9. Changes in the appearance of the product that do not affect product performance.

## HELP

Customer service: [support@duracomfort-life.com](mailto:support@duracomfort-life.com)

Shenzhen TCL Dura Electronic Technology Co., Ltd.

Room 11, 1st Floor, Block A, TCL Building, No.006, Gaixin South 1st Road, Gaixin Zone Community, Yuehai Subdi strict, Nanshan District, Shenzhen, Guangdong, China

**Dura** *Comfort*

**FOR MORE HELP**  
**Customer service:**  
**[support@duracomfort-life.com](mailto:support@duracomfort-life.com)**