

# CAPTAIN 1200

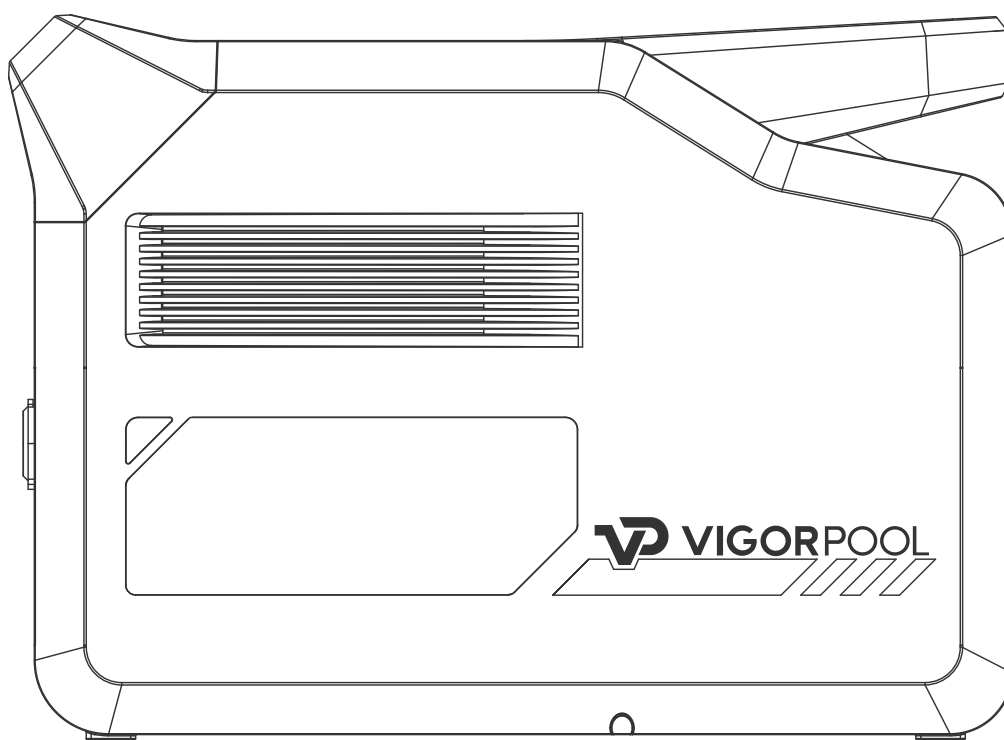

USER MANUAL



# DISCLAIMER

---

## CONGRATULATIONS!

Thank you for purchasing your new VIGORPOOL product. VIGORPOOL strives to create innovative clean energy products with unique designs and excellent performance. VIGORPOOL always try best to make products simple and easy to use.

## WARNING

This user manual contains instructions for safety, operation and maintenance. It's essential to read the entire user manual carefully before setup and use. Failure to read and follow instructions and warnings in this document may damage the product and personal property and cause serious injury.

This document and all other collateral documents are subject to change at the sole discretion of VIGORPOOL INC. For any updates, please visit [vigorpool.com](https://vigorpool.com).

# CONTENT

---

1. What's in the Box .....	2
2. Product Specifications .....	2
3. Start Guides for Users .....	3
3.1 Using Captain 1200 .....	3
3.2 Details of Captain 1200 .....	3
3.3 LCD Screen .....	3
3.4 Multiple Recharging Methods .....	4
3.5 Connect Two Captain 1200 .....	6
3.6 Use of APP .....	6
3.7 Notes on Boost .....	6
3.8 Safety Guidelines .....	7
3.9 How to Store or Use .....	7
4. Troubleshooting .....	7
5. Frequently Asked Questions .....	8
6. FCC Caution .....	9
7. UL2743 Caution .....	10
7.1 IMPORTANT SAFETY INSTRUCTIONS .....	10

## 1. What's in the Box

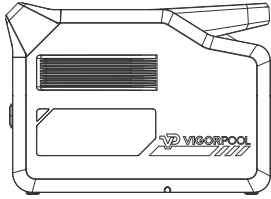

VIGORPOOL CAPTAIN 1200

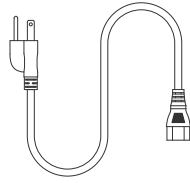

AC Cable

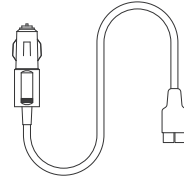

Car Charger to Anderson Cable

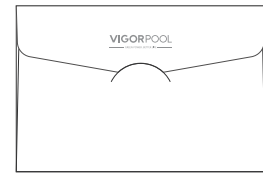

User Manual

## 2. Product Specifications

BATTERY INFO	
Model:	VP21
Capacity:	25.6V 50Ah 1280Wh
Cell Chemistry:	LiFePO <sub>4</sub>
Lifecycle:	3500 cycles to 80%+ capacity
Management System:	Overcharge Protection, Over Discharge Protection, Overload Protection, Short Circuit Protection, Over Current Protection, High Temperature Protection, Low Temperature Protection
OUTPUT	
AC Output (×4):	120V~60Hz 10A, Total 1200W (Surge 2400W)
AC Parallel Inter face (Being Connected):	120V~60Hz, 1200W
USB-A Output (×2):	5V=3A, 9V=2A, 12V=1.5A, 18W Max per port, Total 36W
USB-C Output (×2):	5V/9V/12V/15V=3A, 20V=5A 100W Max per port, Total 200W
DC5521 Output (×2):	12V=3A 36W Max per port, Total 72W
Car Port:	12V=10A, 120W Max (2 × DC5521 Output + Car Power Output: Total 120W)
Wireless Output:	10W Max
INPUT	
AC Input:	120V~60Hz 10.5A
Anderson Input:	12-56V=12A Max, 400W Max
GENERAL	
Weight:	About 33.07lbs (About 15Kg)
Dimensions:	15.98 x 9.4x 11.57 in (40.6 x 23.9 x 29.4 cm)
Charging Temperature:	32-104°F (0-40°C)
Discharge Temperature:	14-104°F (-10-40°C)
Certification:	FCC, UL, CE, UKCA, PSE, MIC, RoHS
Warranty:	24 Months
Optional Accessory:	400W Solar Panel, 200W Solar Panel, 100W Solar Panel
APP Control:	Yes

### 3. Start Guides for Users

#### 3.1 Using Captain 1200

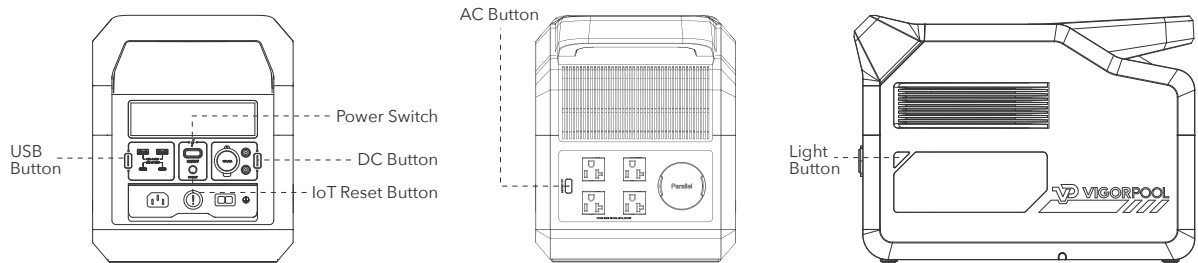

1. Long press the power button to turn on or turn off the LCD screen.
2. If your phone fails to connect with the device, please long press the IoT reset button.
3. With the power button turned on, short press the USB button/ DC button/ AC button to use those ports; short press again to turn them off.
4. Turn on the device, short press the light button to turn on the lights. There are four modes of light: reading, strong, SOS, and flashing.

Please note: For power saving, the VIGORPOOL CAPTAIN 1200 AC output will be turned off automatically after 12 hours if power usage remains under 20W. DC & USB output will be turned off automatically after 12 hours if power usage remains under 5W.

#### 3.2 Details of Captain 1200

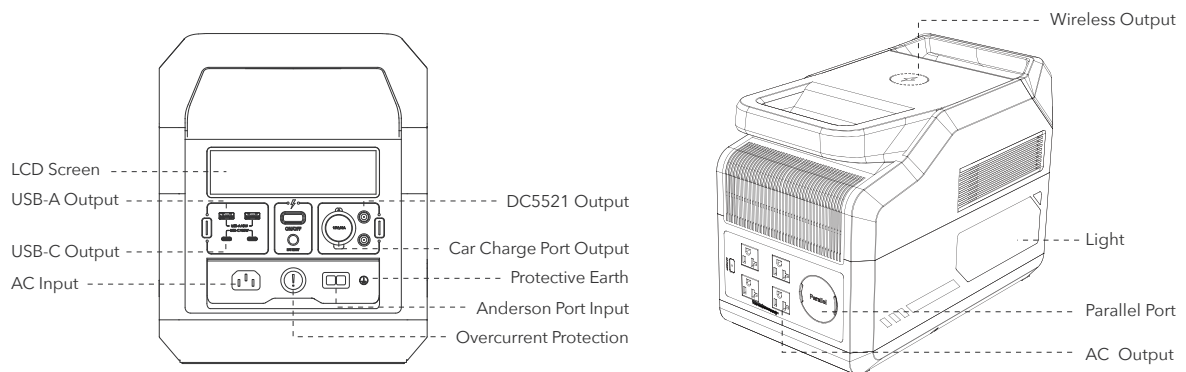

#### 3.3 LCD Screen

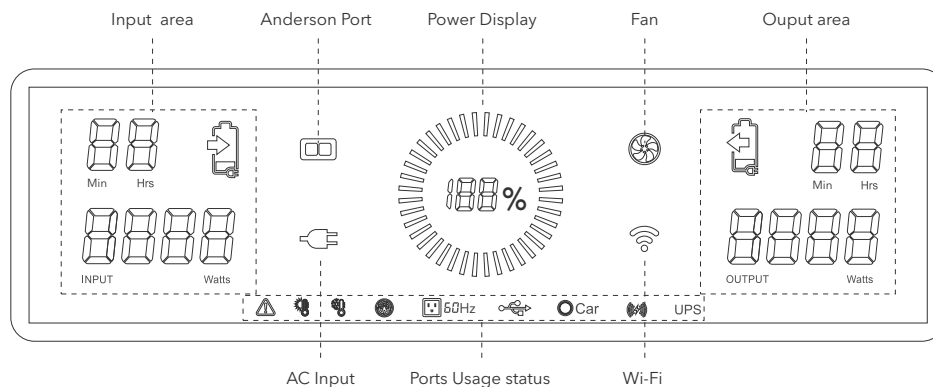

ICON CONTENTS	ICON TYPE
Input Status	Indicates that the CAPTAIN 1200 is charging. There is a display of the remaining charge time and a display of the current power input.
Output Status	Indicates that the CAPTAIN 1200 is powering/charging a device. There is a display of the remaining discharge time and the current power output.
Power Display	Shows the current battery capacity.
Anderson Port	Indicates that the CAPTAIN 1200 is being charged with a solar panel or a car.
AC Input	Indicates that the wall charger is being used to charge the CAPTAIN 1200.
Fan Run	Indicates that the CAPTAIN 1200 current temperature is too high and needs to cool down. At this time, there will be some fan rotation sound.
Wi-Fi	<ol style="list-style-type: none"> <li>1. Click the IOT button to start the IOT function, and the WIFI icon will be on.</li> <li>2. Press and hold the IOT button for 3-4 seconds until the WIFI icon disappears and then release, the WIFI icon will flash, and the device will enter the network configuration state. At this time, use the VIGORPOOL APP to search for the device, click to connect to the server. If the icon is always on, that means the WIFI connection is successful, otherwise the icon will flash.</li> <li>3. Click the IOT button again to turn off the IOT function and the WIFI icon disappears.</li> </ol>
Ports Usage status	Indicates the usage status of each port.

### 3.4 Multiple Recharging Methods

Wall Charging	Solar Panels	Car Charging	Electric Generator
About 2 Hours	About 5.5 Hours	About 14 Hours	About 2 Hours

#### WALL CHARGING:

The CAPTAIN 1200 uses fast charging technology with a maximum input power of 800W; it can be charged up to 80% in 1.5 hours and fully charged in 2 hours. In addition, you can select fast charging 800W, slow charging 200W(silent charging), or custom charging through the App. Default input power is 800W.

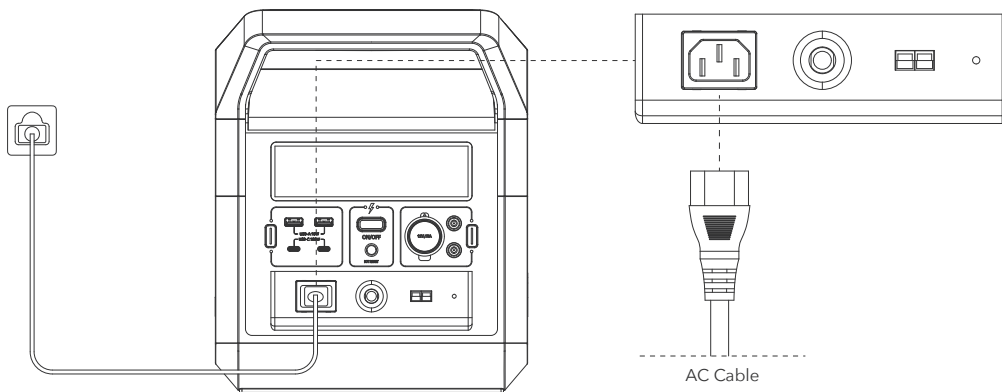

## SOLAR PANEL CHARGING:

Users can choose VIGORPOOL 400W solar panel, 200W solar panel or 100W solar panel to charge the CAPTAIN 1200. The DC input voltage range is 12V-56V, the maximum current is 12A, and the maximum charging power is 400W. In full sunlight, the CAPTAIN 1200 can be charged with two 200W solar panels, which will take about 5.5 hours to complete a full charge.

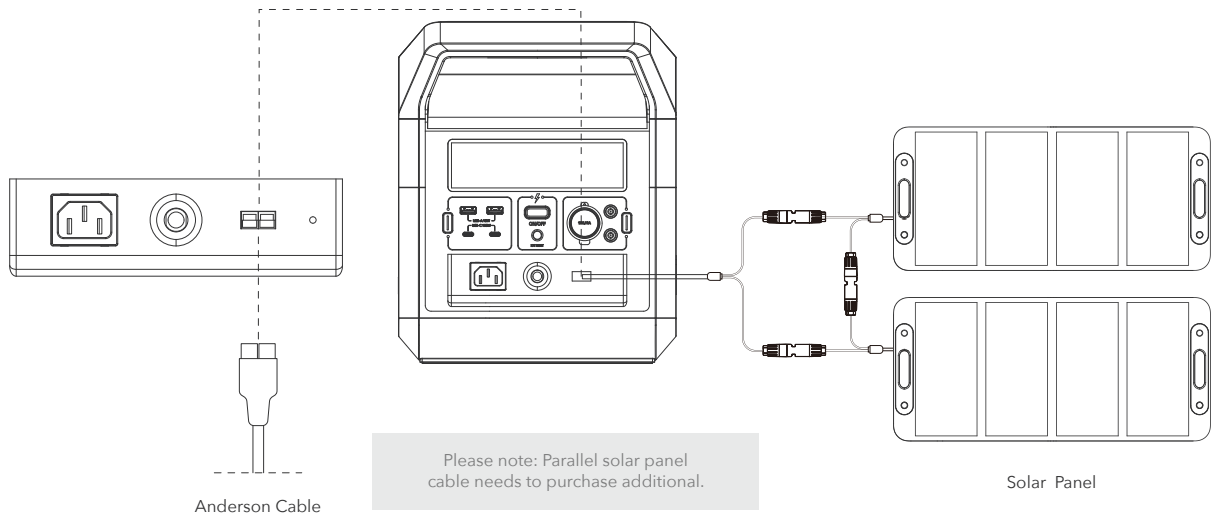

## CAR CHARGING:

The CAPTAIN 1200 can be charged with a car. It supports 12V car charging and takes about 14 hours to fully charge. Charge using the car charger after you've started the car to avoid failure to start due to insufficient car battery. In addition, please make sure that the Car Charging Input Port and the Car Charging Cable are in good condition. VIGORPOOL takes no responsibility for any losses or damages caused by failure to follow instructions.

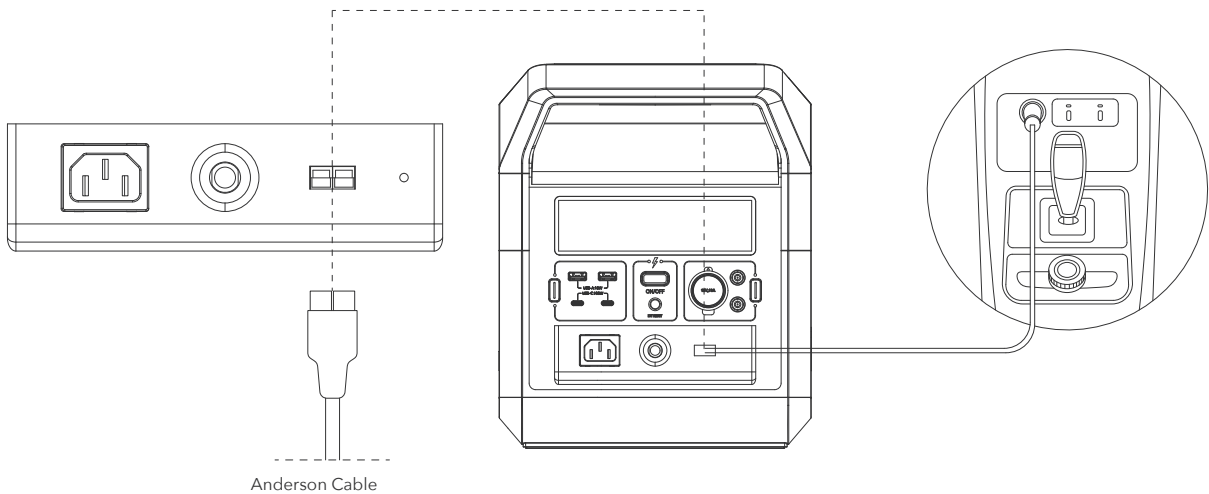



## ELECTRIC GENERATOR CHARGING :

The CAPTAIN 1200 can be charged in about 2 hours using a traditional generator.

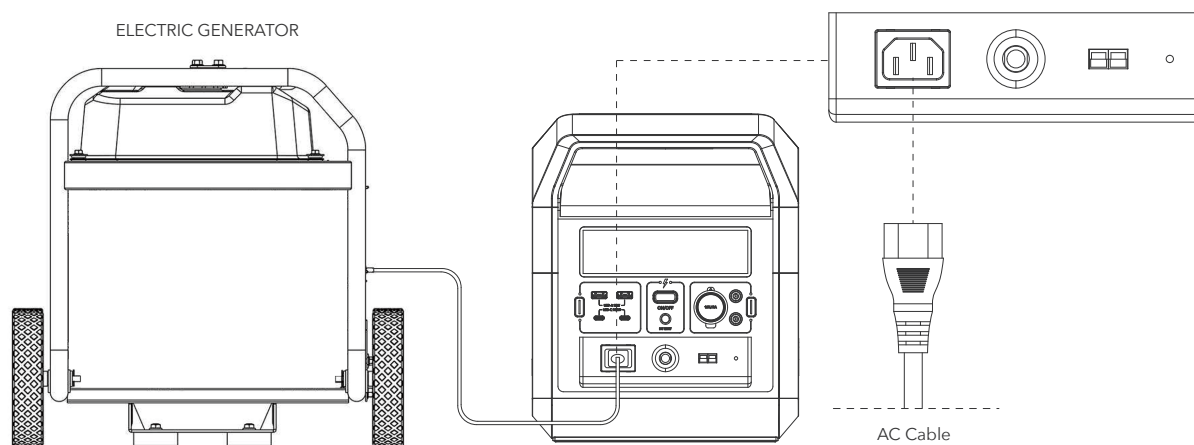

### 3.5 Connect Two Captain 1200

Connect the parallel port of the CAPTAIN 1200 through the parallel cable and turn the AC button on until the parallel graph on the LCD is lit, indicating a successful parallel connection. AC output power provides up to 2400W continuous output, using a capacity of up to 2560Wh. Users can use the AC port on either product. Please avoid using load devices that exceed the rated power of 2400W.

Please note: The parallel cable needs to be purchased additionally.

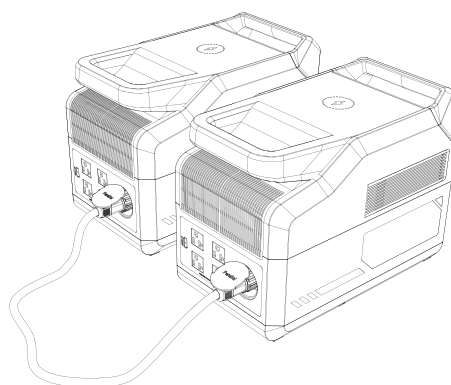

### 3.6 Use of APP



You can view energy forecasting, state monitoring and estimation, and anomaly detection via the VIGORPOOL App. For more details, please download it on the App Store or Google Play and check our official website to get the connect steps:

<https://VIGORPOOL.com/pages/VIGORPOOL-app>

### 3.7 Notes on Boost

Traditional power stations will shut down if the continuous output power is exceeded. In contrast, the CAPTAIN 1200 AC inverter boost function can support most resistive load devices up to 1800W without causing the device to be disabled due to overload protection. This product supports equipment with a maximum power of 1800W, but at this time the rated output power is still 1200W.

When using the Boost feature, please keep the following in mind:

- (1) Pay special attention to the charging state.
- (2) When using an appliance that requires between 1200W-1800W, only use that one appliance. Trying to run multiple AC devices while using the boost feature could result in voltage fluctuations that could damage appliances over time.
- (3) If the 1200W-1800W appliance you are attempting to power with the CAPTAIN 1200 exceeds the unit's surge voltage limit of 2400W when starting the appliance, you may not be able to power that appliance.

## Uninterruptible Power Supply (UPS)

This power generator supports UPS function. You can use the AC charging cable to connect the grid and the AC input port of this power generator, the appliance can be connected to the AC output port of this power generator to work (at this time the AC power comes from the grid, not this power generator), when the power is off, this power generator can automatically switch to battery power mode within 10ms.

Note: This function does not support 0ms switching. Therefore, it is not recommended to be used as a UPS for highly sensitive equipment, such as data servers and workstations without confirming compatibility or proper testing before use. It is also recommended to only use the UPS function for one device at a time to avoid overload protection. VIGORPOOL assumes no responsibility and is therefore not liable for data loss or damage caused by the use of this product in setups that it was not intended for and the disregard of this recommendation

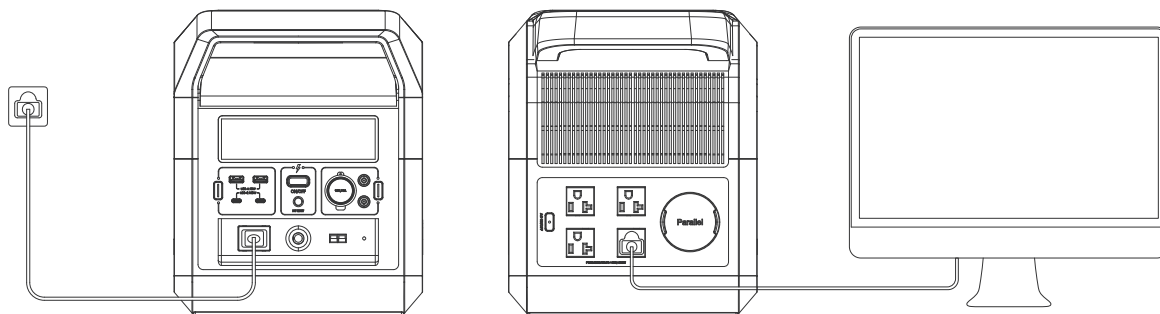

### 3.8 Safety Guidelines







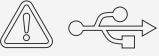

1. DO NOT immerse the product in water or get it wet.
2. DO NOT put the product near heat sources, such as a fire or heater, while using or storing.
3. DO NOT pierce the product casing with a nail or other sharp object, use a hammer to break it open, or step on it.
4. DO NOT let the product make contact with corrosive objects.
5. DO NOT attempt to disassemble this product in any way.
6. DO NOT forcibly lock the fan during use or place the product in an unventilated or dusty area.
7. DO NOT clean the product with water directly. Instead, use a dry cloth to gently clean it.
8. DO NOT replace any components of the product without any official VIGORPOOL permissions.
9. Please contact the official VIGORPOOL channels to get more information if you want to replace any components.
10. DO NOT dispose of the battery directly in a battery recycling box. You should contact a professional recycling company for further processing.
11. DO NOT put the product in an area where children or pets can reach.

### 3.9 How to Store or Use

1. For long-term storage (more than 3 months), the battery needs to be maintained at 50% of the rated capacity (recharged once every 3 months), stored in a dry and cool place and kept away from fire, heat sources, and corrosive substances.
2. To extend the life of the product, it's better to recharge the product before the power drops 15%.
3. The operating temperature of the VIGORPOOL power station is -10-40°C (14-104°F), and the storing temperature is -10-35°C (14-95°F).

## 4. Troubleshooting

Icon Indicator	Problem	Solution	Error code
 Icons Flash together	AC Output Under Voltage Protection	Turn off the AC output and remove the abnormal load. After 10 seconds, the power station should function as usual.	E000

Icon Indicator	Problem	Solution	Error code
 Icons Flash together	USB Output Overload Protection or Short Circuit	Turn off the USB output and remove the abnormal load. After 10 seconds, the power station should function as usual.	E001
 Icons Flash together	DC Output Overload Protection or Short Circuit	Turn off the DC output and remove the abnormal load. After 10 seconds, the power station should function as usual.	E002
 Icons Flash together	AC Output Overload Protection or Short Circuit	Turn off the AC output and remove the abnormal load. After 10 seconds, the power station should function as usual.	E003
 Icons Flash and unit stops charging	AC Input Over Current Protection or Short Circuit	The abnormal state will be cleared automatically after 10 seconds. After that, press the AC input over-current protector button and unplug the charging cable. Then the power station should function as usual.	E004
 Icons Flash and unit stops charging	Solar Panel Input Current Protection or Short Circuit	The abnormal state will be cleared automatically after 10seconds. Then the power supply will be restored.	E005
 Icons Flash and Wireless Stops Working	Wireless charging not working	Remove the abnormal load. After 10 seconds, the wireless function as usual.	E006
 Icon Lights Up	High-Temperature Protection	The power supply can be restored automatically after the battery cools down.	E007
 Icon Lights Up	Low -Temperature Protection	The power supply can be restored automatically after the battery temperature returns to safe operating temperatures.	E008

If you are still having problems, please feel free to contact us at [support@vigorpool.com](mailto:support@vigorpool.com). For additional information, check our official website: [www.VIGORPOOL.com](http://www.VIGORPOOL.com).

## 5. Frequently Asked Questions

### 1. What devices can VIGORPOOL CAPTAIN 1200 power?

A: VIGORPOOL CAPTAIN 1200 can power essential devices less than 1200W (or one device up to 1800W using the inverter boost feature). The total wattage of devices being powered should be under 1200W unless using the inverter boost feature. Please refer to your device specification before purchase.

### 2. What is the VIGORPOOL CAPTAIN 1200 power station lifespan?

A: The VIGORPOOL CAPTAIN 1200 uses lithium iron phosphate battery technology. After 3500 cycles of use, the VIGORPOOL CAPTAIN 1200 power station's capacity will drop to 80%. Lifespan also depends on how the power station is used, maintained, etc.

### 3. Is the VIGORPOOL CAPTAIN 1200 waterproof?

A: The VIGORPOOL captain 1200 is not waterproof, please stay away from water sources.

### 4. Can I use and charge my VIGORPOOL CAPTAIN 1200 simultaneously?

A: Yes, all of our products support pass-through charging. But we don't suggest using it this way very frequently as it will reduce the battery life.

### 5. Can I take my VIGORPOOL CAPTAIN 1200 on a plane?

A: Unfortunately, you cannot. According to FAA regulations, any battery you take on board should not exceed 100Wh. External chargers or power banks are also considered a battery. They should not surpass a capacity of 27000mAh, or in other words, 100Wh.

### 6. Is the VIGORPOOL equipped with an MPPT controller?

A: All VIGORPOOL models have an MPPT controller.

### 7. Can I use third-party solar panels to recharge my VIGORPOOL CAPTAIN 1200?

A: We don't suggest using third-party solar panels because VIGORPOOL's warranty does not cover any damage caused by third-party solar panels.

### 8. Can I jump-start a car using my VIGORPOOL CAPTAIN 1200?

A: Our Captain 1200 can't jump start a car, but it can charge the dead batteries of your car through a car charge cable.

### 9. How to determine if my VIGORPOOL CAPTAIN 1200 is charging?

A: The LCD display will show the remaining charging time when charging, and the battery percentage power indicator will start to rotate.

## 6. FCC Caution

**This device complies with part 15 of the FCC Rules. Operation is subject to the following two conditions:**

- (1) this device may not cause harmful interference, and
- (2) this device must accept any interference received, including interference that may cause undesired operation. Any changes or modifications not expressly approved by the party responsible for compliance could void the user's authority to operate the equipment.

#### NOTE:

This equipment has been tested and found to comply with the limits for a Class B digital device, pursuant to Part 15 of the FCC Rules. These limits are designed to provide reasonable protection against harmful interference in a residential installation. This equipment generates, uses and can radiate radio frequency energy and, if not installed and used in accordance with the instructions, may cause harmful interference to radio communications. However, there is no guarantee that interference will not occur in a particular installation.

**If this equipment does cause harmful interference to radio or television reception, which can be determined by turning the equipment off and on, the user is encouraged to try to correct the interference by one or more of the following measures:**

- Reorient or relocate the receiving antenna.
- Increase the separation between the equipment and receiver.
- Connect the equipment into an outlet on a circuit different from that to which the receiver is connected.
- Consult the dealer or an experienced radio/TV technician for help.

#### FCC Radiation Exposure Statement

This equipment complies with FCC radiation exposure limits set forth for an uncontrolled environment. This equipment should be installed and operated with a minimum distance of 20 cm between the radiator and your body.

FCC ID: 2A5SKVP211200

## 7. UL2743 Caution

A photovoltaic panel as an input for charging the internal battery shall be provided with an inverter and/or a charge controller in accordance with UL 1741 or UL 62109-1; The external power supply shall be a power source in accordance with the Standard UL 60950-1 and CAN/CSA C22.2 No. 60950-1, or UL 1310 and No. 1, CAN/CSA C22.2 No. 223, or No.1, CAN/CSA C22.2 No. 223; A vehicle adapter that complies with the enclosure and input contacts requirements in the Standard for Vehicle Battery Adapters, UL 2089, and Power Supplies, CAN/CSA C22.2 No. 107.1. The connector plug shall incorporate a fuse or other protective device having a current rating not greater than 15 A.

INSTRUCTIONS PERTAINING TO RISK OF FIRE, ELECTRIC SHOCK, OR INJURY TO PERSONS

### 7.1 IMPORTANT SAFETY INSTRUCTIONS

**WARNING - When using this product, basic precautions should always be followed, including the following:**

1. Read all the instructions before using the product.
2. To reduce the risk of injury, close supervision is necessary when the product is used near children.
3. Do not put fingers or hands into the product.
4. Use of an attachment not recommended or sold by power pack manufacturer may result in a risk of fire, electric shock, or injury to persons.
5. To reduce risk of damage to the electric plug and cord, pull the plug rather than the cord when disconnecting the power pack.
6. Do not use a battery pack or appliance that is damaged or modified. Damaged or modified batteries may exhibit unpredictable behavior resulting in fire, explosion or risk of injury.
7. Do not operate the power pack with a damaged cord or plug, or a damaged output cable.
8. Do not disassemble the power pack, take it to a qualified service person when service or repair is required. Incorrect reassembly may result in a risk of fire or electric shock.
9. To reduce the risk of electric shock, unplug the power pack from the outlet before attempting any instructed servicing.
10. **WARNING - RISK OF EXPLOSIVE GASES.**  
To reduce risk of battery explosion, follow these instructions and those published by battery manufacturer and manufacturer of any equipment you intend to use in vicinity of the battery. Review cautionary marking on these products and on engine.
11. **PERSONAL PRECAUTIONS**
  - (1) Have plenty of fresh water and soap nearby in case battery acid contacts skin, clothing, or eyes.
  - (2) Wear complete eye protection and clothing protection. Avoid touching eyes while working near battery.
  - (3) If battery acid contacts skin or clothing, wash immediately with soap and water. If acid enters eye, immediately flood eye with running cold water for at least 10 minutes and get medical attention immediately.
  - (4) NEVER smoke or allow a spark or flame in vicinity of battery or engine.
  - (5) Be extra cautious to reduce risk of dropping a metal tool onto battery. It might spark or short-circuit battery or other electrical part that may cause explosion.
12. When charging the internal battery, work in a well ventilated area and do not restrict ventilation in any way.
13. Under abusive conditions, liquid may be ejected from the battery; avoid contact. If contact accidentally occurs, flush with water. If liquid contacts eyes, additionally seek medical help. Liquid ejected from the battery may cause irritation or burns.
14. Do not expose a power pack to fire or excessive temperature. Exposure to fire or temperature above 130°C may cause explosion. The temperature of 130°C can be replaced by the temperature of 265°F.
15. Have servicing performed by a qualified repair person using only identical replacement parts. This will ensure that the safety of the product is maintained.

SAVE THESE INSTRUCTIONS



Batteries or battery packs must be recycled or disposed of properly. When this product has reached the end of its useful life, it should not be disposed of with other household waste. The Waste Electrical and Electronic Equipment Regulations require it to be separately collected so that it can be treated using the best available recovery and recycling techniques. This will minimize the impact on the environment and human health from soil and water contamination by any hazardous substances, decrease the resources required to make new products and avoid using up landfill space. Please do your part by keeping this product out of the municipal waste stream! The "wheellie bin" symbol means that it should be collected as "waste electrical and electronic equipment". You can return an old product to your retailer when you buy a similar new one. For other options, please contact your local council.



**VIGORPOOL**

TM and © 2022 VIGORPOOL Inc. All rights reserved.

VIGORPOOL.COM