

4WD INTERIORS

SALES & ENQUIRIES, WAREHOUSE & DISTRIBUTION

📍 42 JAYCO DRIVE, DANDENONG SOUTH, 3175

☎ 03 9706 6130 / 07 4035 5066

✉ sales@4wdinteriors.com

TECHNICAL SUPPORT, WARRANTY & SPARE PARTS

☎ 0452 606 971

✉ info@4wdinteriors.com

www.4wdinteriors.com

www.facebook.com/4wdinteriorsCnsMelb

www.instagram.com/4wdinteriors/

<https://www.linkedin.com/company/outback-4wd-interiors/>

4WD INTERIORS



PRODUCT CATALOGUE

STORAGE SOLUTIONS FOR OFFROAD, TRAVEL AND ADVENTURE

ABOUT US

4WD Interiors focuses on providing reliable accessories to meet the needs of 4x4 Off Road , Travel or Work. With high standards in place. 4WD Interiors has been providing quality products for over 40 years.



In **1978** , whilst working in the outback Pilbara and Kimberley regions of Australia, founder of 4WD Interiors, Gary Plant realised that he didn't have easy access to his gear in his 40 series SWB landcruiser, and there wasn't anything suitable on the market. So he designed a dash shelf for "the odd can

of beverage" & other small items. Next came a Top Shelf for the CB radio, books & maps, and an overhead for sleeping gear, towels, jackets etc. After Gary started making them for all his mates too, he registered a business, and sold his products by word of mouth.

And 4WD Interiors was born.

After moving to Cairns, the range of accessories expanded to include Door Pockets, Floor Consoles, Roof Consoles, & Wheel Arch Storage Boxes with False Floors in the back. In **1988**, Gary designed the first ever Roller Drawer System in Australia. This premium quality drawer system took the 4WD industry by storm and is still one of our company's largest selling items.

In **1995**, 4WD Interiors moved to their current location in Portsmith, Cairns. This office still provides an important element, concentrating on our R & D, installation, warranty, technical support & spare parts.

In **2022**, we expanded to include our facility in Melbourne, to handle the majority of our distribution & quality control. Quality control is a very important aspect of our business, and we pride ourselves on our premium product and service.



WHAT WE OFFER

Our customers require gear that lasts and equipment that delivers. That is why 4WD Interiors should be your Number One choice for storage.

WHY CHOOSE US

- 1** A range of quality, reliable accessories designed and built to withstand the harsh Australian conditions.
- 2** Technical Support and Warranty Service you can depend on.
- 3** Online ordering system.
- 4** Australia-wide delivery available through a large network of freight handling companies.



DUAL DRAWER SYSTEMS

**AWARD
WINNING
AUSTRALIAN
DESIGN**

DURABLE AND RELIABLE

4WD Interiors Drawer Systems have been a durable and reliable component of the 4WD industry for over 30 years.

Our drawer system was first produced for off road use in 1989. In 1990, 4x4 Australia featured the new drawer system in their

magazine and gave it the product endorsement rarely given.

In 1993, 4x4 Australia awarded 4WD Interiors the prestigious honour of Best Aftermarket product over \$900

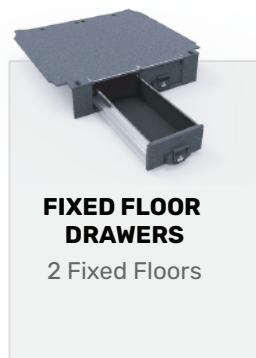

FIXED FLOOR DRAWERS

2 Fixed Floors

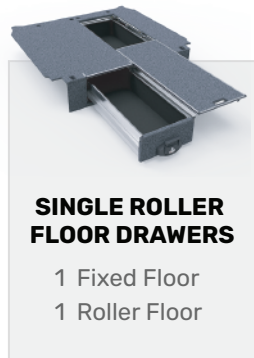

SINGLE ROLLER FLOOR DRAWERS

1 Fixed Floor
1 Roller Floor

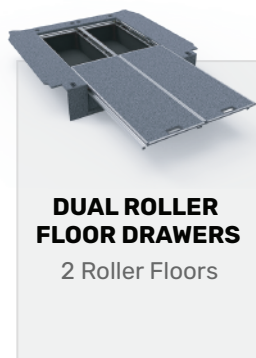

DUAL ROLLER FLOOR DRAWERS

2 Roller Floors

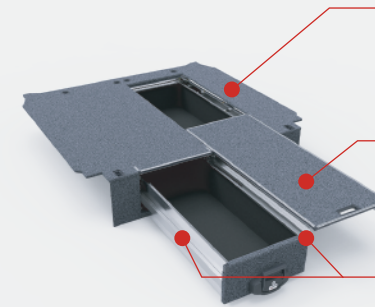

SIDE FLOOR WING KITS

Vehicle Specific Side and Rear Floor Wing Kits to suit your vehicle.

UV STABILISED INDUSTRIAL CARPET

6mm thick heavy-duty hard wearing carpet, UV stabilised resistant to mould, mildew or fading.

STAINLESS STEEL DRAWER RUNNERS & ROLLER FLOOR RUNNERS

Stainless Steel Drawer & Roller Floor Runners ensure smooth and effortless operation.



CHILD RESTRAINT ANCHOR POINTS

Two child restraint anchor points are standard on drawers to suit wagons.

(Landrover Defender excluded)



SAFETY HAND GAP

With safety in mind, a 30mm gap is located on top of the drawer to prevent injury.



LOCKABLE, SLAM LATCH HANDLES

Purpose designed push-pull, lockable handles, keeping your contents secure.

AUSTRALIAN DESIGN RULE (ADR)

4WD Interiors Drawer Systems and Child Restraint Anchorages have been crash tested for your safety and comply to ADR

ADR42/03 General Safety Requirements
ADR34/01 Child Restraint Anchorages

ADR3/02 Seats and Seat Anchorages
AS/NZS 4034.2:2001 Partial Cargo Barriers for 60kg capacity



SIDE FLOOR WING KIT

Vehicle specific

Contoured to suit your vehicle.

Generic

DIY installation for specialised vehicles.

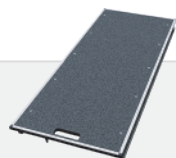

ROLLER FLOOR ASSEMBLY

For conversion of Single Roller Floor Drawers to Dual Roller Floor Drawers.

Floor assembly only, bearings, fittings and hardware are included on both sides of Single Roller Floor Drawers.

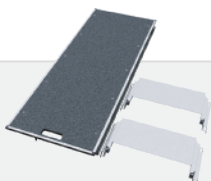

ROLLER FLOOR INSTALLATION KIT

For conversion of Fixed Floor Drawers to Single Roller Floor Drawers OR Dual Roller Floor Drawers.

Floor assembly includes bearings, fittings and hardware in installation kit.

FOLD DOWN ANCHOR POINT KIT

Roller Floor Drawers supplied with a set of 4- fold down anchor points.

Great for multi-purpose tie down applications.

- Stainless Steel
- Easy Installation
- Extra Anchor Points available for purchase



DRAWER DIVIDERS

- 1 supplied per drawer
- Position to suit your requirements
- Easy DIY Installation
- Extra dividers available for purchase



INSTALLATION EXAMPLES

ROOF CONSOLES

4WD Interiors Roof Console was awarded 4x4 Australia Magazine's "Best 4x4 Aftermarket Product Under \$900" for the year 2000 which pays testimony to the design work, features and benefits this Console exhibits.

INTEGRATED STORAGE SOLUTION

Our Roof Console is an all-in-one solution for your everyday driving needs, and provides an accessible Storage Compartment provision for Radio, Switches or extra storage. LED Driver/Passenger and Rear Seat lighting.



WAGONS, DUAL CABS & EXTRA CABS



SINGLE CAB & CAB CHASSIS

OPTIONAL ACCESSORIES & PARTS

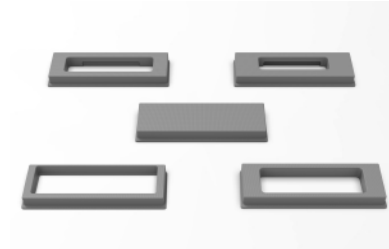

RADIO INSERTS

Four (4) radio inserts are available to suit most popular radio brands. There is also a blank insert for installation of other radios, which can be cut to suit. Please confirm your radio make and model before purchasing.

REPLACEMENT FRONT LED

Replacement Front LED Lights available for purchase.



REPLACEMENT REAR LED

Replacement Rear LED Lights available for purchase.

ROOF CONSOLE PACKAGE INCLUDES

- Console with LED lights
- Microphone Cable Holder
- Installation Kit



MOLDED LEATHER GRAIN LOOK

This modern console with leather grain look complements the interior of your vehicle.



1 INTERIOR LIGHTS

Energy Saving LED lights provide better lighting for your interior. Lights turn on automatically when doors are opened. Lights switch on and off independently when doors are closed.

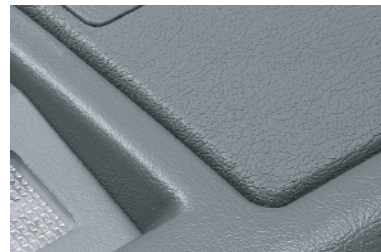

2 SMART LEATHER GRAIN LOOK

Neutral grey colour and textured finish that is easy to clean.



4 INTEGRATED BLUETOOTH GRILL

Bluetooth grill is incorporated in each console. Voice input into the manufacturer's Bluetooth microphone will not be compromised.



6 LINED STORAGE COMPARTMENT

Lined storage compartment designed to keep your personal belongings organised and secure. Rattle-free and easy to click shut.



Front Lights

DIN SIZE RADIO SURROUND 3

DIN size radio surround/storage tray is incorporated in the console. Standard DIN Size: 172mm x 50mm



MICROPHONE CABLE HOLDER 5

A microphone cable holder is supplied with each console.

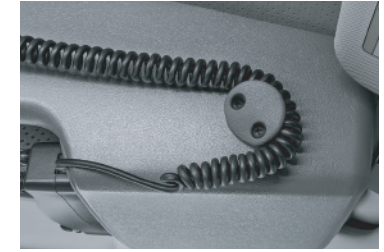

HALF CARGO BARRIERS

4WD Interiors Half Cargo Barrier, fitted to your drawers, gives protection from unexpected accidents or sudden stops. With our Red Dot hand bolt fastening points they're easily removed.

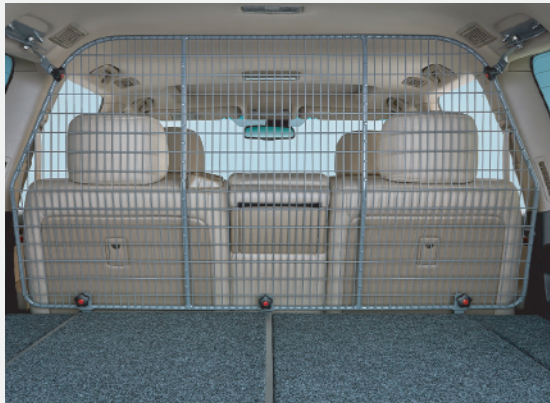

HALF BARRIER

As an upgrade choice for your drawer system, our Half Cargo Barrier is designed to protect you and your family from unrestrained gear being thrust forward, should a collision or sudden stop occur.

With easy installation and removal, a Half Cargo Barrier is highly recommended to complement your drawer system.

HALF CARGO BARRIER PACKAGE INCLUDES

- Half Barrier
- Mounting Brackets
- Installation kit

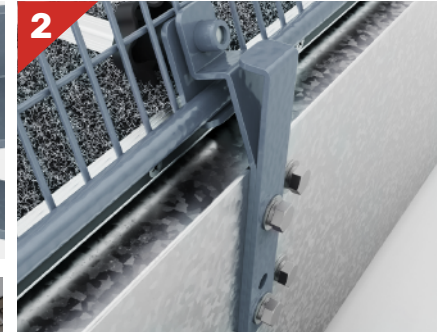
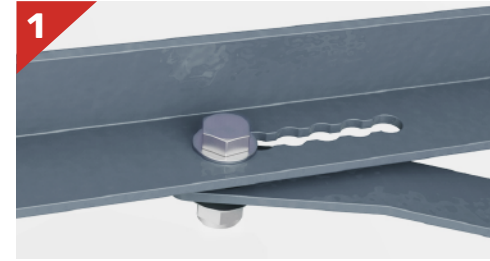

1. NYLON GRIP BRAKE ASSEMBLY

Nylon grip takes up first impact force, serrations slow secondary impact force.

2. BOTTOM MOUNTING BRACKETS

Takes up first and second impact force.

3. ANIMAL FRIENDLY

This smart storage solution provides a safe environment for your pets to relax and enjoy the ride. Install this product in conjunction with your drawer system for a pet friendly journey.

4. INTERNATIONAL STANDARD GRID DISTANCE

Our Half Cargo Barriers are strictly in accordance with international Cargo Barrier wire mesh grid distance of 50mm x 20mm, ensuring occupant and cargo safety.

AUSTRALIAN DESIGN RULE (ADR)

4WD Interiors Drawer Systems and Child Restraint Anchorages have been crash tested for your safety and comply to ADR

ADR42/03 General Safety Requirements
ADR34/01 Child Restraint Anchorages

ADR3/02 Seats and Seat Anchorages
AS/NZS 4034.2:2001 Partial Cargo Barriers for 60kg capacity

REAR RACK & DIVIDERS

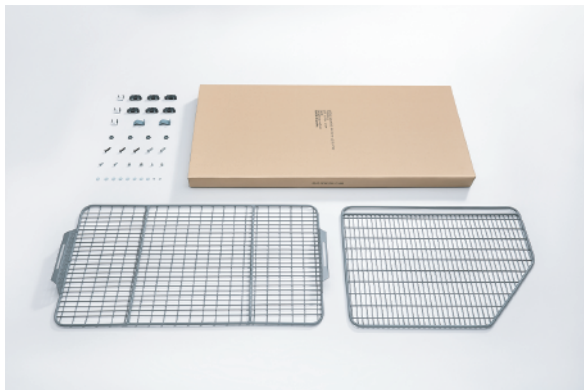

MAXIMISE YOUR REAR STORAGE AREA

As an upgrade for your Drawer System and Barrier, our Rear Rack & Divider is designed to maximise the storage space in your vehicle.

REAR RACK & DIVIDER PACKAGE INCLUDES

- Rear Rack Mesh
- Mounting Brackets
- Install Kit
- Divider Mesh & Clamps
- Connecting Brackets



MESH & BAR CLAMPS

Purpose designed 'Mesh & Bar Clamps', molded in reinforced nylon, are used to clamp Rack to Divider and Barrier. No Squeaks - No Rattles!



STAINLESS STEEL FIXING CLAMPS

Stainless steel fixing clamps with protective rubber coverings fasten the Rear Rack and Divider to the drawer floor, and steel framework below it.



ROUND STEEL SOLID FRAMEWORK

4WD Interiors Rack & Divider, used in conjunction with the Half Barrier, offers a storage solution to ensure your cargo is always safe and secure.



Whether it's luggage, gear or a fridge, you'll have no problem organising things to suit your needs.

AUSTRALIAN DESIGN RULE (ADR)

4WD Interiors Drawer Systems and Child Restraint Anchorages have been crash tested for your safety and comply to ADR

ADR42/03 General Safety Requirements

ADR34/01 Child Restraint Anchorages

ADR3/02 Seats and Seat Anchorages

AS/NZS 4034.2:2001 Partial Cargo Barriers for 60kg capacity

HEAVY DUTY FLOOR EXTENSION

INCREASE YOUR FLOOR STORAGE AREA

Our Heavy Duty Floor Extension is used in conjunction with our Half Cargo Barrier.



Barrier is positioned forward to rear of front seats, offering huge floor space with storage under Rear Seat area- great for two travelling on an extended trip!

- Forward position Mounting Kit purchased Separately.
- A second Barrier may be installed, one Barrier rear and one forward.

SUITS: Landcruiser 200, 100, 76 & 80 Series, Prado 150 Series and Patrol GU models



UNIVERSAL DOOR POCKETS

Convenient storage for small items with our universal door pockets

Our Door Pockets are designed to provide an accessible option for your small items. Our Pockets can be installed just about anywhere in your vehicle: inner doors, rear panels, you name it! Easy Installation with instructions supplied-suitable replacement for all 70 Series Landcruisers.



UNIVERSAL DOOR POCKETS PACKAGE INCLUDES

- Large pockets x2
- Small pockets x2
- Installation Kit



TOP SHELF

Our Top Shelf is an ideal storage solution, with enhanced LED interior/reading lights, designed for use with existing sunvisors, to ensure your comfort and safety.

SUITABLE FOR FOLLOWING VEHICLES

Landcruiser Troop Carrier 1985 ... ON: Cab Chassis 1985 to Aug 2016: Dual Cab 08/2012 ... ON: 76 Wagon 2007...ON.

Note: *Does not suit vehicles with 5 STAR ANCAP RATING with AIR BAGS

*Does not suit vehicles with crash sensor (SEPT 2022 ON)

*Does not suit models built SEPT 2022 ON



Upgrade your driving experience with our Top Shelf.
Complete with two bright LED lights, sure to add practicality to your interior!

CONVENIENT STORAGE

- Injection molded body & integrated brackets
- soft feel leather look grain finish

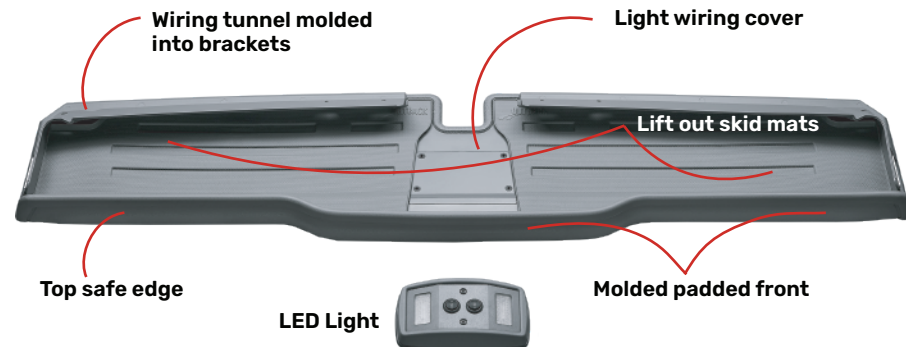

QUALITY FEATURES



ENERGY-SAVING LED LIGHTS

Pair of energy efficient LED lights brighten up your interior.



REINFORCED

To resist against warping or deformity.

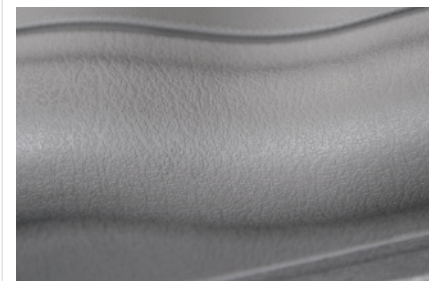

LEATHER GRAIN LOOK

With its molded leather look, a Top Shelf will enhance your cabs interior.



PROTECTIVE RUBBER EDGING

The shelf has a padded front for safety.

TOP SHELF PACKAGE INCLUDES

- Top Shelf
- LED Light Pod
- Wiring Kit
- Installation Kit

