

DESIGNED AND TESTED  
**IN AUSTRALIA**  
FOR THE GLOBAL MARKET

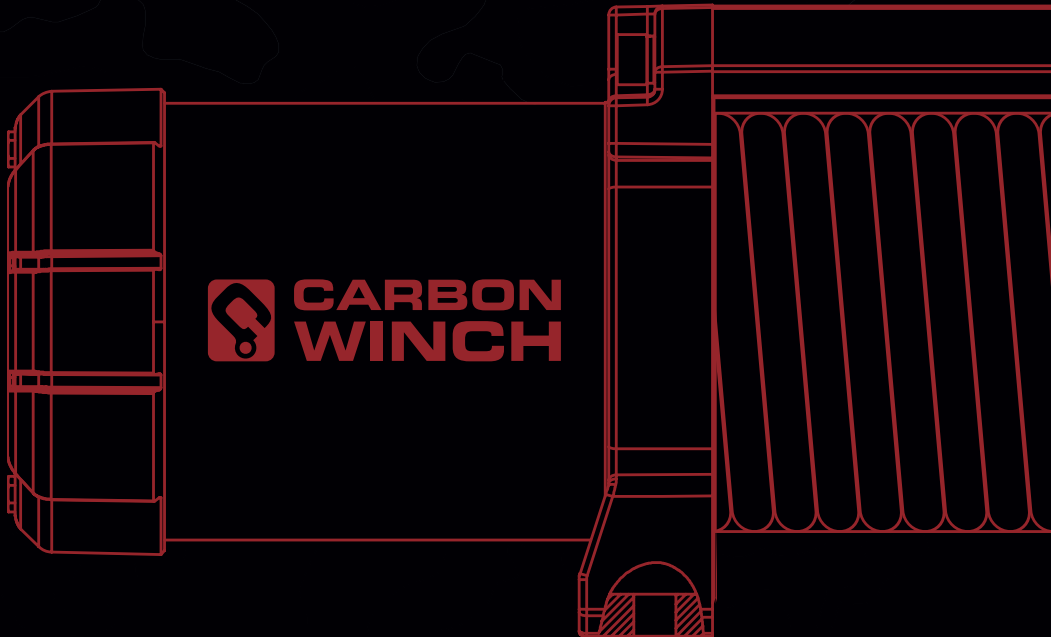

# USER MANUAL



---

**Thank you for purchasing your Carbon Offroad electric 4x4 vehicle recovery winch. With proper care and preventative maintenance you will maintain a dependable service life and safe operation from your winch.**

**Carbon Offroad reserves the right to continuously update, make changes and improvements without notice. Please read the instructions carefully and fully understand how to install and operate a winch safely before attempting to install the winch. Please ensure you operate your winch safely in accordance with these instructions.**

**Note; Please keep these instructions in your vehicle at all times for reference. It is highly recommended that you undertake an off-road winch training course from a reputable company before using the winch. This manual is not intended as a substitute for completion of an accredited winch training course.**

---



For hints and tips on installation, visit our social channels and Youtube channel for supporting content to this manual



## **TABLE OF CONTENTS :**

---

Introduction & Box Contents	04
Warnings & Safety	05
Basic Installation Guide	06
Winch Testing	07
Winch Gearbox Rotation	08
Winch Mounting	11
Winch Vehicle Mounting	12
Control Box Mounting	13
Winch Rope Preparation	15

# BOX CONTENTS PARTS LIST

## Please check contents before installation

- |  |  |
|--|--|
| 1 x Carbon Winch   | 1 x Stubby cooler                                |
| 1 x Synthetic winch rope   | 1 x Isolator switch Inc. fitting hardware        |
| 1 x Winch fairlead   | 1 x Isolator short red wire to battery cable     |
| 1 x Winch instructions manual  | 1 x Winch hook                                   |
| 1 x Winch control box with attached motor wires                                | 1 x Wireless remote carabiner lanyard            |
| 1 x Wireless winch remote control installed with 2 x 23A/A23 12 volt batteries | 1 x Winch hook hand saver                        |
| 1 x Wired winch remote control   | 1 x Plastic conduit main battery cable protector |
| 1 x Packet of mounting hardware  | 1 x black negative battery cable                 |
| 4 x Square head nuts   |  |
| 4 x 5/8th / 16mm hex head bolts  |  |
| 4 x Flat washers   |  |
| 4 x Spring washers   |  |
| 2 x Longer 5/8th / 16mm hex head bolts for alternative fairlead mount          |  |
| 2 x Additional nuts for control box mounting                                   |  |
| 1 x 3mm Allen key  |  |
| 1 x 4mm Allen key  |  |
| 1 x 6mm Allen key  |  |
| 2 x Fairlead 10mm Allen head bolts, 2 x nuts, 2 x washers, 2 x lock washers    |  |

# GENERAL SAFETY INFORMATION

Throughout this manual, you will find notations with the following headings:

**DANGER:** Indicates an imminently hazardous situation which, if not avoided, will result in death or serious injury.

**WARNING:** Indicates a potentially hazardous situation which, if not avoided, could result in death or serious injury.

**CAUTION:** Indicates a potentially hazardous situation which, if not avoided, may result in minor or moderate injury. This notation is also used to alert against unsafe practices.



Read Owner's Manual

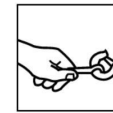

Always Use Handsaver



Keep clear of winch, wire rope and hook while operating

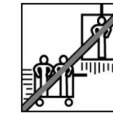

Never use winch to lift or move people



Never use winch to hold loads in place

# WINCH INSTALLATION SAFETY WARNINGS

Correct installation of your winch is a requirement for correct operation.

It is highly recommended that the Carbon Winch is installed by a qualified or authorised technician who understands the importance of the safety requirements that come with the winch installation.

**CAUTION:** The winch is designed primarily for intermittent use with a maximum of 30 sec continued use with a minimum rest period of 30 seconds. This winch is not designed to be used in industrial or hoisting applications and Carbon Winch does not warrant it to be suitable for such use. This winch is not designed to lift, hold or transport people.

Your winch is a very powerful machine, if used unsafely or improperly, there is a possibility that property damage, personal injury or death could result.

- Once you have unboxed your winch, please inspect the winch and all hardware for any transport damage or improper manufacturing.

- Do not install the winch if you find any broken or damaged parts. Please contact your retailer or place of purchase immediately for replacement parts.
- Please ensure you are mounting the winch on a flat even surface to ensure the motor and gearbox are aligned correctly.
- Ensure you are attaching the winch to a winch compatible bullbar, housing or product.
- The battery used to power the winch must have a minimum rating of 650 CCA and be in good working order.

This winch MUST be mounted with the rope running in the direction indicated on the end plate, Improper mounting could damage your winch and void your warranty.

## BASIC INSTALLATION GUIDE/PROCESS

Please read all steps before attempting installation

1. Read this manual and fully comprehend the seriousness of winch installation and use.
2. Check you have all listed components in your box - refer to box parts list.
3. Check over the winch and components and ensure all bolts are tightened to specification.
4. Test the operation of the winch - installation & familiarisation
5. Gearbox and motor rotation if required
6. Install the winch into the vehicle mount
7. Install the winch into the vehicle
8. Installing the control box
9. Install the wiring harness
10. Check all wires and mounts
11. Pretensioning the winch rope
12. Winch operation and safety

## NUT AND BOLT TORQUE SETTINGS

Bolt sizes below represent the head size or socket size required  
Ensure you use a medium grade thread locker for all nuts and bolts

Do not tighten any bolts with an impact wrench.

Gearbox Housing	3mm allen head bolts	2.26 - 2.82Nm
Tie bars	6mm allen head bolts	15Nm
Winch to mounting cradle bolts	5/8th / 16mm hex head bolts	55Nm
Fairlead Mount bolts	10mm allen head	45Nm
Control box bracket to winch mount	4mm allen head bolts	2.26 - 2.82Nm
Motor end plate bolts	10mm hex head	4.5Nm
Motor terminal bolts	13mm hex head	15Nm
Winch rope to drum	Allen head Bolt	15Nm

## WINCH TESTING & FAMILIARISATION

It is a good practise to test the winch and understand its operation prior to completely installing it

- Secure the winch to either a bench or a suitable strong object (the winch cradle works well) so you can safely test its operation. **CAUTION:** Do not test the winch unless it's secured or mounted, as the winch rope can grab underneath and roll forwards and cause injury or death. See winch mounting instructions for details.
- For this test application, bolt the control box to the top of the winch using the metal bracket and the two already secured bolts on the top of the motor side of the winch housing.
- Wire the control box to the winch as per wiring diagram and instructions. See control box mounting.
- Turn the winch clutch handle to freespool allowing you to manually pull the rope out, then thread approx 1 metre of the rope out
- Turn the clutch handle back to engage, this will click in once the winch starts turning and operating. You can manually engage the rotating ring gear clutch by pulling firmly on the rope, a click will be heard, this is the clutch pin engaging into the ring gear.
- Ensure there are no wires or body parts near the drum and rope area
- Connect a battery (that is not connected to the vehicle) to the winch battery leads
- Black wire to negative - and red wire to positive + Ensure you wire in the isolator switch as well for added precaution to enable you to turn off the winch.
- Cycle the winch out and in, using both the wired and wireless remote controls (press and hold both buttons on the wireless remote to activate)
- Familiarise yourself with how the winch works and operates prior to installation.
- **CAUTION:** please ensure all body parts are away from the winch drum/rope area during this test and familiarisation process.

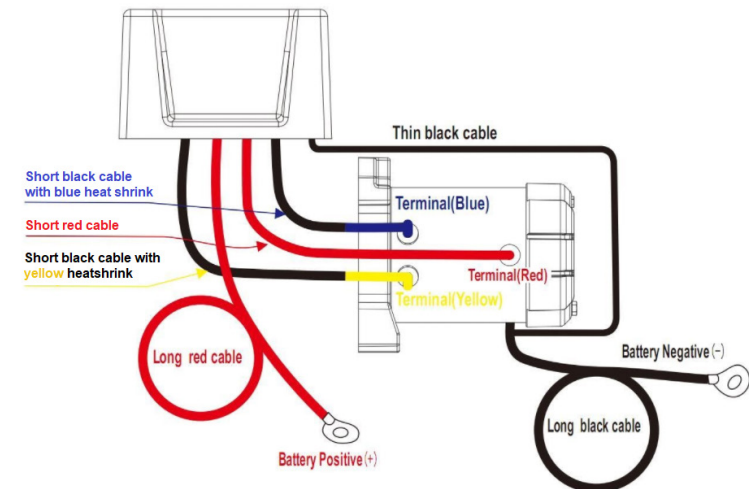

# WINCH GEARBOX ROTATION

---

In many cases of installation the winch clutch handle is not always accessible from the standard 12 o'clock position. You can rotate the gearbox to locate the clutch handle to a better more accessible position. This is best done on a bench with the winch not mounted to the vehicle.

## CW-12K Gearbox Rotation

- Stand up the bare winch (without the control box mounted) onto the motor end, secure the winch in place so it does not fall over.
- With the supplied 6mm allen key, undo and remove the tie bar bolts on the gear box side (this has a handle on it)
- Lift up the gearbox and attached end plate away from the drum and motor, there will be a shaft attached to the centre of the gearbox so you must lift up straight until it clears the drum.
- Place the gearbox on its bottom with the drive shaft pointing upwards and you will see ten allen key head bolts between where the drum and the winch housing meet.
- Undo and remove these bolts
- You will now be able to rotate the gearbox to the desired location.
- Do Not separate the end plate from the gearbox housing, only turn the end plate.
- Once you have rotated the gearbox to the right location, align the bolt holes and thread back all ten bolts into position(finger tight) .
- Torque all ten bolts in a crosshatch star configuration - tightening the opposites. This is to correctly centralise the gearbox to the end plate housing, if you fail to do this correctly the gear box shaft will be misaligned. And will side load the gears and cause premature failure.

- Ensure you torque the gearbox mounting bolts to 2.26-2.82Nm of torque. and use a medium threadlocker
- Remove the winch drum with the rope off the motor winch end and thread over the drive shaft centralising it into position ensuring it seats into the bushings and seals correctly. Turn the drum while seating into position.
- Once the drum is seated place the motor on top of the drum verifying the location of the keyway at the end of the driveshaft
- Turn the motor end of the winch until it drops into the keyway on the drive shaft
- Realign the winch tie bars that you removed previously and refit the bolts and tighten to 15 Nm of torque and use a medium thread locker
- Check all bolts are tight and have been torqued to specification
- Before installation check that the winch free spool and motor operation works correctly without any unfamiliar noises. See winch testing and familiarisation
- If you hear any unfamiliar noises, repeat the steps above to correctly centralise the gearbox.

**Note:** Do not use impact drivers as this may lead to stripping of the threads

## CW-XD Scout Pro Extreme Duty Winch

### Gearbox rotation:

- Stand the winch on its motor end with the gearbox uppermost
  - Remove the 8 allen head machine screws holding the clutch handle housing to the main gearbox housing
  - Give the clutch housing section a light tap to release from the main housing piece, do not separate from the main housing completely. Be careful not to damage the sealing o-ring.
  - Rotate the housing to put the clutch/free spool handle in your desired position. DO NOT separate the housing from the rest of the winch as the drive shaft will separate from the primary drive gear or motor drive. This can be quite fiddly to realign and will require more in-depth disassembly of the winch.
  - During this process take care not to damage the rubber sealing o-ring
  - Replace machine screws and tighten in a star pattern as you would wheel nuts.
  - Torque bolts to 2.26-2.82Nm or 20-25in/lbs (inch pounds NOT ft/lb)
  - Check operation of handle and free spool mechanism.
- Note:** Do not use impact drivers as this may lead to stripping of the threads

## WINCH MOTOR ROTATION

### In some cases you may need to rotate the winch motor for access to the motor terminals

- Stand the winch up on its gearbox side and secure appropriately so it doesn't fall
- Mark the location of both the bolts in relation to the winch end plate to make it easier to realign the motor.
- Undo both of the winch motor end bolts with a 10mm socket and remove.
- Do not remove the end cap. If you accidentally remove the end cap make sure the seal is aligned correctly before putting it back together.
- You may need to gently tap the main housing to release from the drum end plate. Gently rotate the motor body 180 degrees to the other location
- Using your alignment marks to drop the bolts back in, you may need to slightly turn the housing back and forth while turning the bolts with your fingers for realignment.
- Once both bolts have dropped into their threads, finger tighten both bolts
- Then evenly tighten to 4.5Nm torque with a 10mm socket

## WINCH MOUNTING

### Before mounting the winch ensure you have worked out the best accessible clutch handle location on the gearbox as this is rotatable depending on bullbar/mount accessibility.

- Install mounting kit or structural support for winch if not already fitted or included on the vehicle.
  - Ensure the winch is mounted to a flat even surface that is at least a minimum of 6.0mm thick and is suitable for a winch mount using the supplied 4 x square head nuts, bolts, washers and lock washers.
  - These bolts must be tightened to 55 Nm of torque and use medium grade thread locker.
  - The winch must be mounted with the arrow on the drum end plate facing forwards and the fairlead rope must operate from an underwound orientation.  
**CAUTION:** In some factory bullbars from Nissan and Toyota it is mandated due to the position of the winch in the cradle that the rope is exited off the top of the drum to line up with the rope outlet on the bar. In this case the winch will need to be fitted with the arrow pointing back towards the engine, the rope should then be fed back around the back of the drum and over the top to exit the winch in this manner. You must consult the OEM winch cradle installation manual from your vehicle manufacturer for confirmation. **WARNING:** Do not unspool the rope and wind back on the other way, this may cause damage and failure of the automatic brake mechanism.
  - Place the square nuts inside the winch feet slots on the winch. (Pro tip - silicone the nuts into position to prevent them from falling out when you are mounting a winch to the plate)
  - Thread the 4 x bolts with the flat and lock washers provided into the nuts in the winch and tighten.
  - Attach the fairlead to the mounting plate using the supplied 2 bolts, nuts, flat and lock washers provided and use a medium lock tight. Tighten to 45 Nm of torque
  - The ends of the mounting bolts must not bottom out in the winch body and must fully engage the threads in the nuts. If this occurs add additional washers to the bolt to prevent bottoming out.
  - **WARNING:** Make sure there are no sharp edges that can contact the winch rope during operation. You must visually inspect the rope path from the winch drum all the way through to the outlet of the fairlead. On some bullbar models the fairlead mounting holes are not centrally located to the rope outlet, and you may find that when the fairlead is mounted the rope will be touching the inside edge of the steel rope outlet before it feeds onto the fairlead. It is vital to ensure that the fairlead position is such that no other component of the bar will touch the rope from fully wound in to fully wound out. You will note that the angle of rope outlet off the drum changes as it is spooled in or out, so check both extremes for clearance. The rope will break under load if it is subjected to any edge or component that is not the fairlead mount.
  - Ensure the mounting surface for the winch is flat for correct winch alignment and operation
- Fairlead Style Mounting** - In some applications it is easier to install the fairlead into the same mounting holes as the bottom of the winch. Use the 2 longer mounting bolts supplied in the bolt kit for this purpose to run through the fairlead, mounting plate and into the winch mounting square nut mounts. Tighten to 55 Nm of torque and fasten with thread locker.
- WARNING:** Do not substitute any strength grade weaker than ISO grade 8.8 bolts and nuts

## WINCH VEHICLE MOUNTING

- Disconnect the vehicle's battery to prevent electrical shock, fire or shorts.
- **WARNING:** When installing the winch ensure you allow ample battery cable slack between the bullbar and the front of the vehicle to allow for movement between the body and chassis of the vehicle.
- Reminder - rotate the gearbox to suit your accessibility for your bullbar or mourning system
- Please ensure that the winch rope cannot rub on any sharp edges inside the mounting area and the winch rope and drum are free from any electrical wiring.

## CONTROL BOX

**Familiarise yourself with the control box and understand where each cable terminates before installation. It is recommended to bench test the winch and wiring before full installation. (see winch testing section)**

- Before attaching the control box cables to the motor ensure you thread on the rubber terminal protectors to the appropriate coloured wires.
- Black cable with the blue tab connects to the blue tab terminal on the motor
- Black cable with yellow tab connects to the yellow tab terminal on the motor
- The short red cable connects to the red tab terminal on the motor
- **IMPORTANT:** The thin black cable must connect to the earth cable terminal on the winch motor. Do not connect to the body of the vehicle or anywhere else. This is essential for reliable solenoid operation.
- The thick long black cable terminates between the negative terminal of the vehicle's battery and the black terminal on the winch motor. Connect this black cable to the winch motor only at this stage, and do not connect to the battery. This cable must be directly connected to the negative terminal of the battery. DO NOT bunch on top of other accessory wires.
- The long red cable from the control box connects to the positive terminal of the vehicle battery; but must be used with the supplied isolator switch. When installing this cable ensure you use the supplied conduit to prevent shorts/fire and allow enough slack between winch and vehicle body to deal with body mount movement on the chassis.
- Ensure you use two 13mm spanners to tighten the terminals, if the top terminal nut is overtightened it can turn the lug internally of the motor and crack the internal motor terminals. This is an incorrect installation and not covered under warranty.
- To prevent this from happening use two spanners one on the bottom nut to only secure it and stop it from rotating and one on the top nut to tighten. Tighten to 14 NM of torque.  
**Note:** Only turn and tighten the top nut.  
**Note:** if you have located the control box in a difficult to reach location for the operation of the wired remote. You can purchase a wired remote plug extension kit and situate it in a more convenient location. Part number - CWA-PLUGEXTKIT\_V2

## CONTROL BOX MOUNTING

- The control box has multiple ways of being mounted, depending on the room available and style of bullbar.
- Standard - in the middle over the winch drum
- Offset - above the winch motor ( better access to the winch rope and drum area)
- Rear middle - behind the drum
- Offset rear - behind the motor
- Remote mounting - You can also mount the control box in front of the radiator support area behind the grill ( you are supplied additional nuts if you require them for this style of mounting)
- On top of bullbar - You can also mount the control box on top of the bullbar and attach it to the bullbar simply by drilling holes on the top section of your bullbar and securing it with bolts and nuts.
- Please ensure the control box is mounted securely to the vehicle and the cables do not rub on the vehicle surfaces and edges as this may cause a short/fire.

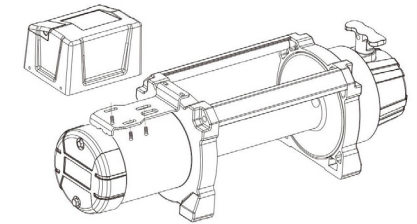
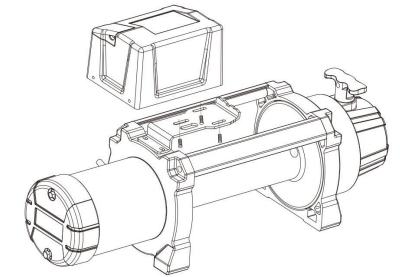

## CABLE ROUTING

**When routing the cables ensure you do not bend the wires sharply around corners and ensure they do not rub on any metal surfaces as this may cause a fire or short circuit.**

- Please use the supplied conduit for the positive red cable terminating to the positive side of the battery. positive terminal of the battery, make sure when you are doing this, that the isolator switch is connected but in the off position.
- It is the best practise to conduit all cables for a better installation and secure them with cable ties
- Make sure you leave some slack in the cable between the bullbar/chassis mounted terminated wires and the body. This is due to the flexible rubber body to chassis mounts.
- Once you have terminated all the wires and secured them. Re-check that you have wired them correctly.
- Your last step is to connect the red cable to the

## ISOLATOR SWITCH INSTALLATION

The isolator switch that is supplied with your winch is a very important part of the installation. It enables you to turn the power off to the winch in an emergency situation and also isolates power to the winch when you are not intending to use the winch. For good risk management always turn the isolator switch to the off position when the winch is not in use

- This has many benefits such as preventing electrical shorts and fire.
- You must install the isolator switch to maintain your winch warranty.
- The switch must be located nearest to the battery under the bonnet of the vehicle
- Do not mount the isolator switch close to the winch.
- The isolator switch comes with a short lead of wire, this is connected to the Positive terminal of the battery.
- Choose a location close to the battery you can use a good quality double sided tape for mounting or bolt/screw the switch to surrounding plastics or engine bay avoiding heat sources.
- The isolator switch has 4 x knock outs so you can easily configure the wires
- Ensure when tightening the nuts you do so with two spanners this will prevent you from breaking the terminals.
- Only turn and tighten the top nut, use the other spanner to hold the lower nut in place.

**WARNING:** Batteries contain gases which are flammable and explosive. Wear eye protection during installation and remove all metal jewelry. Do not lean over the battery while making connections.

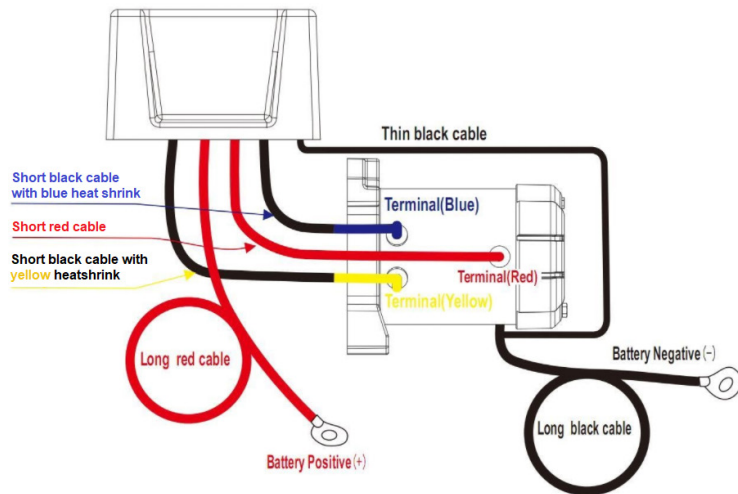

## WINCH HOOK CONNECTION

Once you have installed your winch you will need to connect the winch hook to the winch rope.

- Make sure you do this once the rope has been threaded through the fairlead
- Simply pull through the fairlead approx 2 metres of rope to make it easier.
- Remove the pin from the winch hook and slip the clevis onto the winch rope thimble.
- Replace the winch hook pin threading it through the rope thimble then secure with the supplied split pin.
- Push the split pin through the hole at the end of the pin and bend back onto itself using pliers.
- Make sure the pin cannot slip out.
- Always use a new split pin if you are removing or replacing the hook.

## WINCH ROPE PREPARATION

When you receive your new winch, the rope has not as yet been pretensioned onto the drum. It has only been wound onto the drum during the factory test procedure. Pretensioning the rope tightly winds it onto the drum to prevent binding, or layers of rope cutting through to below layers.

- Spool out the winch rope from your installed winch that's attached to your vehicle until the warning sheath appears ensuring you have 5 winds of rope left on the spool.
- Attach the rope to a secured object, and slowly pull the vehicle towards the fixed point using the winch. Ensure you do this safely with a winch damper blanket and rated recovery gear i.e tree trunk protector.
- Ensure there is no one in front of the vehicle or close by for safety reasons.
- Do not loop the winch rope back around on itself and fasten with the winch hook, this will damage the winch rope.
- From the safety of your vehicle operate the winch with either your wireless or wired remote and wind the winch in.
- Ensure you apply a small amount of resistance with your brake to make the winch rope wind tightly onto the drum or utilise a slight incline.
- Make sure the rope is evenly distributed across the winch drum.
- Once you have spooled the rope in, ensure you attach the hook to a recovery point on your vehicle or secure it by pulling it up to the fairlead. For safety keep your hands away from the fairlead area while guiding the rope in and always hold the hand saver strap do not hold the hook.
- Make sure you turn off the isolator switch once you have completed this task.
- Now your winch is ready for recovery operation. It is recommended that you attend an accredited winch recovery course before operating your winch in a recovery situation.



## WINCH ROPE MAINTENANCE

To prolong the life of your winch rope a few simple maintenance procedures are needed to be followed.

- If your winch has been exposed to mud and dirt simply remove the rope from the winch and wash then rinse in plain water, do not use soap, detergents or bleaches or chemicals as these will weaken the synthetic rope.
- Exposing your winch rope to prolonged sunlight will damage your rope as the UV light will break down and weaken the fibres. Store your winch rope away from direct UV light.
- If your winch rope has been exposed to salt water make sure you rinse the rope thoroughly to remove all traces of salt water.
- Inspect your winch rope regularly for cuts, abrasions and fraying - Do not use the winch if any damage has occurred and replace the rope with a new one with the equivalent ratings and specifications.

## WINCH REMOTE CONTROL OPERATION

Your Carbon Winch is supplied with two types of remote controls to operate the winch, it is always best to keep both in the vehicle in case of failure of one or the other. The winch wireless remote receiver comes already installed into the control box, below is an images on how this is done.

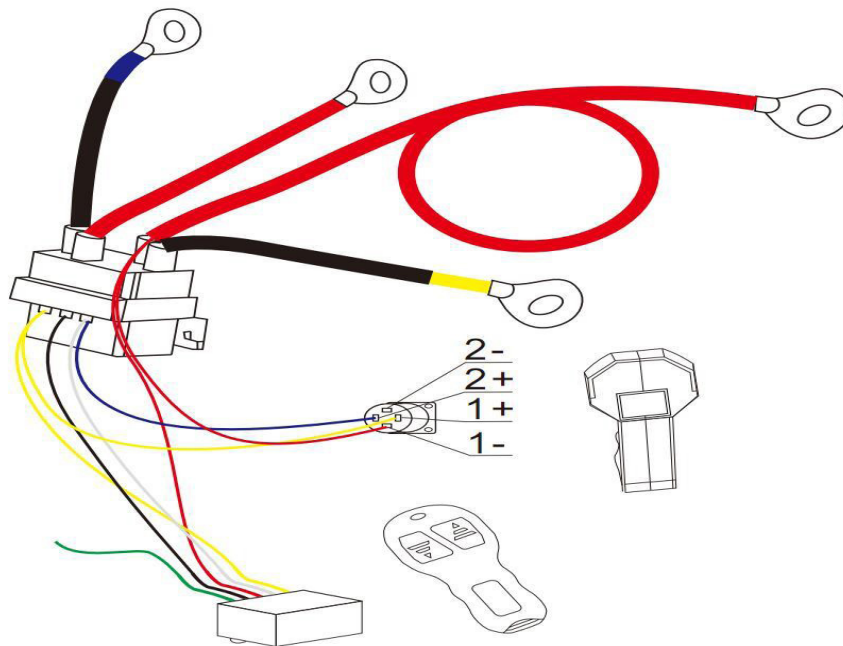

### Wireless Remote

- To turn on the wireless remote simply press and hold both buttons for 2 seconds simultaneously, this will activate the remote. You will notice a red light flashing indicating that ITS TURNED ON.
- To turn off the remote power, simply press and hold both buttons for 2 seconds simultaneously and the light will rapidly flash then turn off.
- The remote will automatically turn off after 90 seconds of no use to save batteries and provide a failsafe if placed back into storage with it still on.

### Replacement of Batteries

- If the light doesn't flash after holding down the two buttons you will need to replace your batteries.
- Replacement batteries requires 2 x 23A or A23 12 volt batteries
- To replace the batteries simply use a small phillips head screwdriver and remove the screws on the back. You can now open up the remote and locate the two batteries.
- Both batteries face upwards with both battery Positives + facing upwards

### Storage - WARNING:

- It is imperative that you store your remote in a safe cool dry place in your vehicle
- Ensure you don't not store it underneath items as this may activate the remote and may start winching. Further preventative measure is to always turn your isolator switch to the off position while not in use to prevent this from happening. In some cases garage remotes can have the same signal as the wireless remote and can operate the winch without you knowing.

### Wired Remote

- The wired remote comes with 3.7m lead, so you can easily operate the winch from the driver's seat.
- For safety do not stand in front of the vehicle and operate the winch
- The wired remote cable simply plugs into the control box, this will be either located on top of the bullbar or behind it depending on your installation.
- Gently lift up the rubber insulator on the top of the control box, you will see a socket
- Gently push the winch remote plug onto this socket and turn it to the right to lock it in
- To remove, pull up the slide lever on the side of the plug and turn it to the left then remove
- Replace the rubber insulator to prevent water ingress
- If you have located the control box in a difficult position you can purchase an extension plug and mount it in a more convenient location. Part number - CWA-PLUGEXTKIT\_V2
- Always remove and store away the wired remote control once you have finished winching

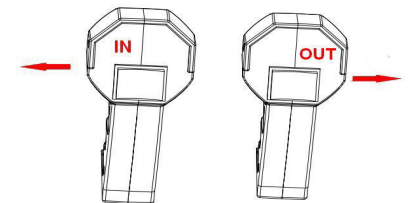

# WINCH OPERATION

## Winch Duty Cycles

The Carbon Winch is designed for intermittent periodical use, as a rule of thumb you require a winch with a maximum line pull of at least 1.5 times greater than the combined vehicle mass including towed items. You will also need to take into account the surface/terrain you are winching on or in and the incline as well.

## Intermittent Duty

An electric winch is like any other motor driven power tool such as an electric drill or saw. The electric motor should not be allowed to become excessively hot. Normal precautions will extend the life of your motor. Keep the duration of pulls as short as possible with a maximum of 30 sec continuous line pull, always allow the motor to cool down for a minimum of 30 seconds. **If the end of the motor becomes uncomfortably hot to touch**, stop winching and allow the motor to cool down.

The maximum working load capacity is on the rope layer closest to the drum. **DO NOT OVERLOAD. DO NOT ATTEMPT PROLONGED PULLS AT HEAVY LOADS.** Overloading can damage the winch and/or the synthetic rope and create unsafe operating conditions. **FOR LOADS OVER 1/2 RATED CAPACITY. WE RECOMMEND THE USE OF A PULLEY BLOCK TO DOUBLE LINE THE ROPE (Figure2).** This reduces the load on the winch and the strain on the rope by approximately 50%. Attach hook to load bearing part. **The vehicle engine should be running during winch operation.** If considerable winching is performed with the engine off, the battery may be too weak to restart the engine.

## FREESPOOL OPERATION

The clutch on this winch is a rotating ring gear style; it has multiple holes that the pin from the clutch handle drops into.

Rotate the clutch handle to the "Free" position as shown in Figure 8. If there is a load on the rope, the clutch handle may not pull out easily. Do not force the clutch handle.

Release the tension on the clutch by pulling out some of the synthetic rope.

Release the clutch and pull out the rope and secure it to an anchor point or load. Check that there are at least five (5) turns of rope left on the drum. Re-engage the drum by returning the clutch handle to the "Engaged" position. (See Figure 8).

**CAUTION:** The Clutch must be fully engaged before winching. Never engage the clutch handle while the drum is turning.

Figure 8

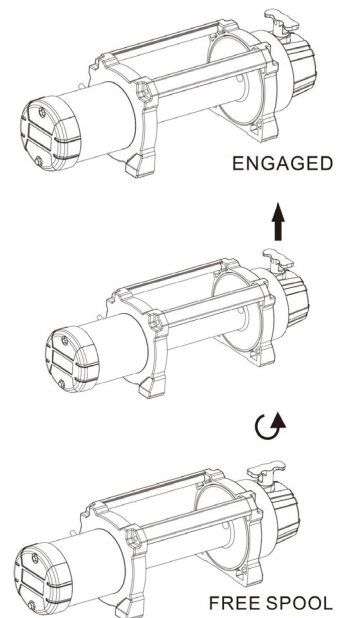

## REMOTE CONTROL OPERATION

Both the wired and wireless remotes activate a solenoid that supplies power to the winch motor.

To connect the wired controller, remove the cover on the plug receptacle on the control box and insert the plug end of the remote. Gently push it in and turn to the right, when removing you will need to lift up the latch on the side of the plug and turn to the left.

The switch trigger returns to the "Off" position when released.

To change direction, move the toggle in the other direction.

**CAUTION:** The switch assembly must be kept free of dirt and moisture to ensure safe operation

**CAUTION:** To prevent unauthorised use of the winch, remove remote control and store in a clean dry area such as the glove box

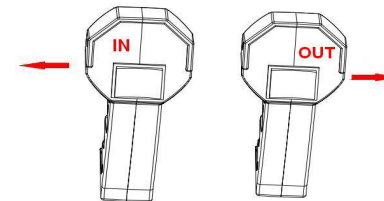

## WINCH USE BASIC STEPS

Below are the basic steps to winching please read and understand all safety instructions before winching. It is strongly advised you attended an accredited winch and 4wd recovery course before attempting a recovery.

- Turn the winch clutch handle to free spool and pull out the rope and hook.
- Connect the hook to a suitable mounting point with the use of rated recovery gear.
- Use a winch damper blanket for additional safety (as close to the hook as possible)
- Turn the winch clutch handle back to the engaged position
- Turn the isolator switch to the on position
- Use either the wired or wireless remote controls to operate the winch
- Make sure you operate the winch from the safety of inside your vehicle and ensure others are well clear from the winching area.
- Make sure your vehicle is running as the winch will drain the battery very quickly
- Proceed safely to use the winch intermittently ensuring you do not exceed the maximum 30 sec on, min. 30sec off. If the winch motor is labouring and becoming hot use a pulley block to half the strain on the winch motor, rope and vehicle chassis.
- Make sure you use the winch hand saver when winding the winch rope back onto the drum after the recovery.
- Turn the isolator switch back to the off position for safety.

**WARNING:** The rope may break before the winch stalls. For heavy loads, use a pulley block to reduce the load on the rope.



Read Owner's Manual



Always Use Handsaver

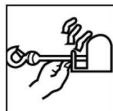

Keep clear of winch, wire rope and hook while operating

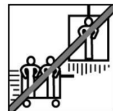

Never use winch to lift or move people

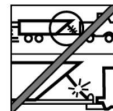

Never use winch to hold loads in place

## WINCHING TECHNIQUES AND SAFETY

After reading and understanding this manual, please learn to use your winch by attending an accredited 4wd winch recovery course. After installing the winch, practice using it so you will be familiar with it when the need arises.

- DO NOT 'move' your vehicle to assist the winch during a winch recovery. The combination of the winch and vehicle pulling together could overload the rope and the winch.
  - Always stand clear of the rope, hook and winch. In the unlikely event of any component failure, it's best to be out of harm's way.
  - Inspect the rope and equipment frequently, a frayed synthetic rope with broken strands must be replaced immediately.
  - Always replace the rope with the identical replacement parts. Periodically check the winch installation to ensure that all bolts are tight, due to vehicle vibrations.
  - Use riggers gloves or equivalent when handling rope. DO NOT LET THE SYNTHETIC ROPE SLIDE THROUGH YOUR HANDS.
  - Never use the winch with less than 5 turns of synthetic rope on the drum as the rope end fastener will not withstand the full load.
  - For safety of you and others keep clear of the winch, the rope/hook during operation.
  - Never put your fingers through the hook. If your fingers become trapped in the hook, you could lose your finger. ALWAYS USE THE HANDSAVER when guiding the synthetic rope in or out (See figure 3)
  - Never obscure the winch warning instruction labels
  - Always operate the winch with an unobstructed view of the winching operation.
  - Recovery equipment such as hooks, pulley blocks, straps, etc. should be rated for the winching task and be inspected for damage after every use.
  - Never release the free spool clutch under load
  - Never work on or around the winch drum area while the winch is under operation or load
  - Do not operate the winch while under the influence of drugs, alcohol or medication.
  - Always disconnect the winch battery leads before working in or around the winch drum area to prevent the winch from being turned on accidentally.
  - During a winch recovery, slowly take up the rope slack until it becomes taut. Stop, recheck all winching connections. Be sure the hook is properly seated. If a Winch extension or Tree strap is used, check the attachment to the anchor point.
  - When using your winch to recover another vehicle, place the vehicle transmission into neutral, set the vehicle brake, and chock all wheels.
  - Do not use the winch to hold loads in place. Use other means of securing loads such as rated tie down straps.
  - Use only the supplied switches, remotes and accessories. The use of non-factory approved components may cause injury or property damage and could void your warranty.
  - **WARNING:** Do not machine, weld or modify any part of the winch. Such alterations will weaken the structural integrity of the winch and will void your warranty.
  - **DANGER:** Do not connect the winch to A/C current 240V (mains power) This is an automotive 12 or 24 volt winch dependent on which type you purchased
    - Electrical shock or death and motor burnout will occur.
  - **DANGER:** Never allow shock loads to be applied to the winch or the rope.
- WARNING:** Use caution when pulling or lowering a vehicle up and down a ramp or incline. Keep people, pets and property clear of the path of the load and also in the winch area danger zone between the anchor point and the vehicle.
- DANGER:** Never use your winch for lifting or moving people.
- DANGER:** Your winch is not intended for overhead hoisting operations.

Figure 3

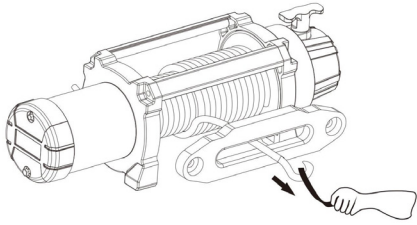

**Warning** - Always use the hand saver to guide the rope back into the fairlead

**Single Line or Double Line Pull**

During winching operation the winch begins to struggle due to incline, vehicle weight or terrain (mud). Use a double line pull to assist the winch with a pulley block that halves the load on the winch, rope and vehicle chassis. Figure 2

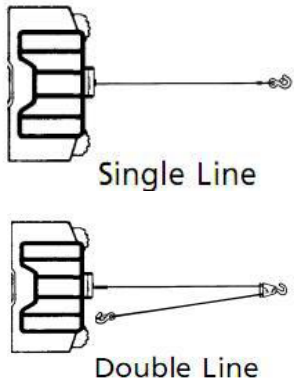

**Winch Hook Use**

Never attach the hook back onto itself as you could damage the synthetic rope. Use a Tree Trunk protector strap instead. (Figure 4)

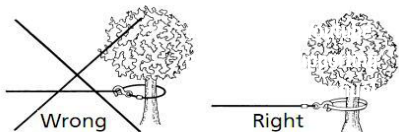

When operating the winch you must use a winch damper blanket or jacket over the rope nearest to the hook end when operating the winch (Figure 5). If a rope failure should occur, the winch blanket will act as a damper and help prevent the rope from whipping back towards you causing injury or death. Specific damper blankets can be purchased see website for details.

Figure 5

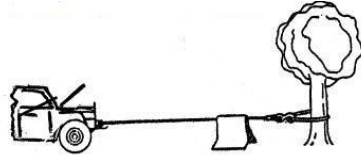

Avoid continuous pulls from extreme angles as this will cause the rope to bind up on one end of the drum (Figure 6). This can jam the rope in the winch, causing damage to the rope or the winch.

Figure 6

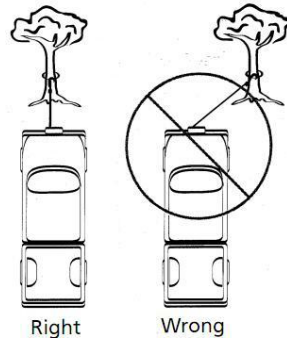

**WARNING:** The responsibility for safe installation and operation of the winch and prevention of personal injury and property damage ultimately rests with you, the installer and operator. There is no substitute for the use of good judgment and caution in operating a winch.

**MAINTENANCE SCHEDULE**

Please carry out all inspections listed below on the schedule and inspections, they are divided into before every use, monthly and 3 monthly. Clean all connections as corrosion on electrical connections will reduce performance or may cause a short.

Classification of check			Item	Checking method	Checking reference	
Before every use	Periodical					
	One month	Three month				
		*	Complete winch	Operate the winch in and out	Minimise corrosion of the internal motor components	
*			Installation	Mounting bolts & alignment	Bolts tension & wear	Tightened and aligned
*			Remote control	Working	Manual	Reasonable actuation
		*		Wearing in contact points	Visual	Free of wear or damage
*			Rope	Broken strands	Visual, measuring (Monthly)	Less than 10%
*	*			Decrease in rope diameter	Visual, measuring (Monthly)	7% of nominal Diameter max
*				Deforming or corrosion and fastening condition of end	Visual	No existence of abnormalities
		*	Freespool	Wear in spring	Visual evidence of wear	Free of wear or damage
		*	Motor	Visual damage	Visual evidence of wear	No existence of abnormalities
		*	Brake			
*		*		Performance	check operation on an incline	engaged no slip
		*	Gearbox	Damage wearing	Visual / operational evidence of wear	Free of wear or damage and distortion

For the most up to date product and warranty information please visit the website.

For any service or warranty claims please contact your place of purchase.



# CARBON WINCH K SERIES (CW-12K)

## PARTS LIST & ASSEMBLY DIAGRAM

Part	Description	Quantity
1	Motor assy	1
2	Motor bracket	1
3	Braking assy	1
4	Bushing	2
5	Rubber seal	2
6	Drum	1
7	Tie rod	2
8	Drive shaft	1
9	Gearbox bracket	1
10	Gearbox seal	1
11	3rd ring gear	1
12	3rd stage carrier	1
13	2nd stage carrier	1
14	1st stage carrier	1
15	1st and 2nd ring gear	1
16	Sun gear	1

Part	Description	Quantity
17	Bearing	1
18	Gearbox house	1
19	Clutch assy	1
20	Wireless	1
21	Remote control	1
22	Rope	1
23	Hook	1
24	Strap	1
25	Alum.Fairlead	1
26	Pad	1
27	Connect plate	1
28	Bottom plate	1
29	solenoid	1
30	Control box	1
31	Rubber cover	1

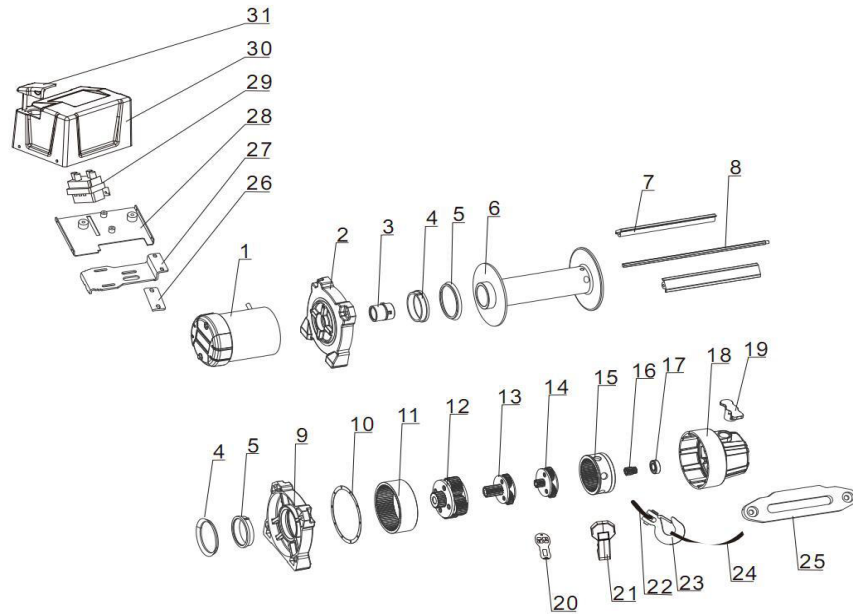

# CARBON WINCH SCOUT PRO EXTREME DUTY SERIES (CW-XD12, CW-XD15)

## PARTS LIST & ASSEMBLY DIAGRAM

Part	Description	Quantity
1	Motor assy	1
2	Motor bracket	1
3	Braking assy	1
4	Bushing	2
5	Rubber seal	2
6	Drum	1
7	Tie rod	2
8	Drive shaft	1
9	Gearbox bracket	1
10	Gearbox seal	1
11	3rd ring gear	1
12	3rd stage carrier	1
13	2nd stage carrier	1
14	1st stage carrier	1
15	2nd ring gear	1
16	Sun gear	1

Part	Description	Quantity
17	Bearing	1
18	Clutch assy	1
19	Gearbox housing	1
20	Wireless remote	1
21	Wired Remote	1
22	Rope	1
23	Hook	1
24	Strap	1
25	Alum. fairlead	1
26	Pad	1
27	Connect plate	1
28	Bottom plate	1
29	solenoid	1
30	Control box	1
31	Rubber cover	1

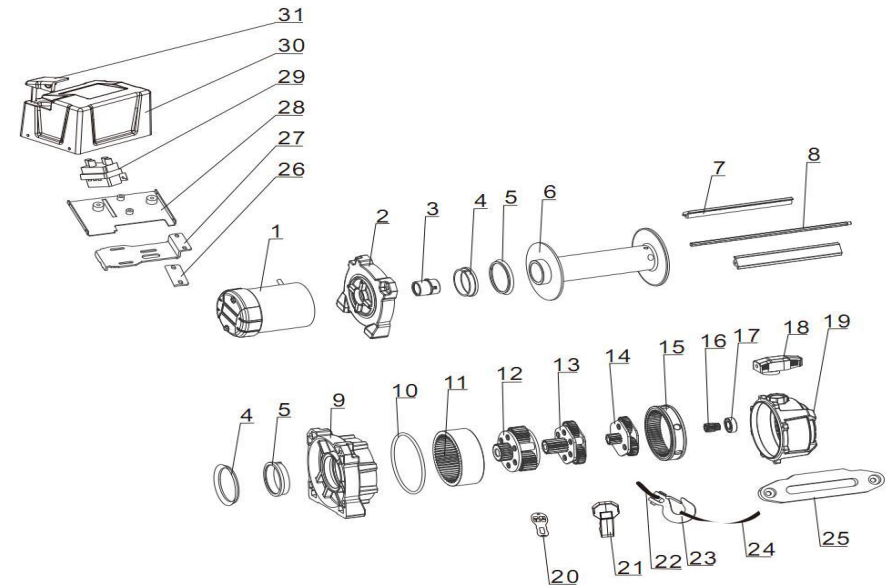

# GET A WINCH YOU CAN TRUST



For premium recovery gear, suspension  
and other 4x4 accessories please visit:

[CARBONOFFROAD.COM.AU](http://CARBONOFFROAD.COM.AU)



 SCAN ME