



3.3KW Can Bus Charger HK-MF-144-23-A 144 Volt



Overview

The **HK-MF-144-23-A** 3.3KW CAN Bus 108 Volt Charger features a small form factor and high efficiency. Built in features include both Output over-voltage and over-current protection.

Other features include reverse polarity protection as well as under-voltage and under-current protection. The unit is fully sealed and waterproof, making it suitable for most environments. Manufactured in China by TC Chargers.

Specifications

AC Input Voltage Range:	AC 90V ~ 264V
DC Output Voltage Range:	50 - 198VDC
AC Input Frequency:	45Hz ~ 65Hz
Full Loading Efficiency:	≥93%
Shock & Vibration:	QC/T 895-2011
Operating Temperature:	-40C ~ 85C
Charging Control:	CAN BUS
Cooling Method:	Electric Fan

Protection Features

Output Over-voltage:	Stops the output when the output voltage exceeds + 1% of max output voltage
Output Over-current:	Stops the output when the output current exceeds + 1% of max output current
Short Circuit Protection:	Unit will automatically stop output if short detected
Reverse Polarity:	Charger will not operate if polarity is reversed
Input Under-voltage:	If AC input is lower than 85V unit will shut down
Input Over-voltage:	If AC input is greater than 265V the charger will shut down
Thermal Self Protection:	The charging current reduces automatically if internal temp exceeds 85C

Physical Dimensions – HK-MF-108-32-A Charger

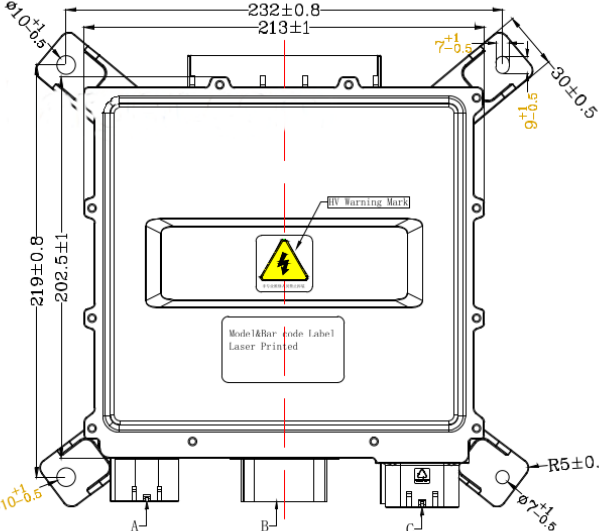
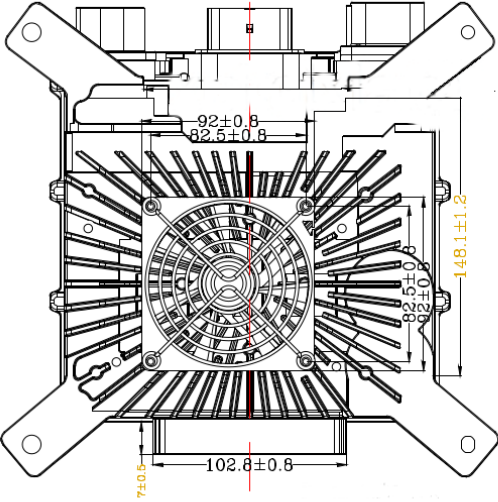
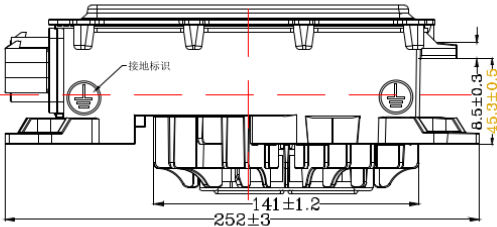
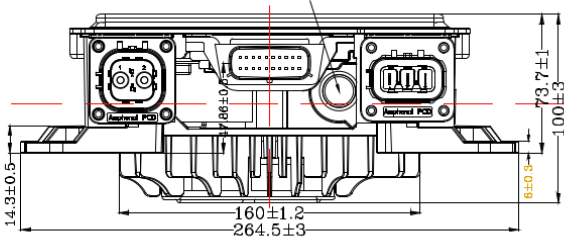

Pin Connectors - HK-MF-108-32-A Charger

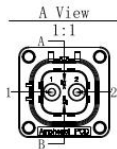
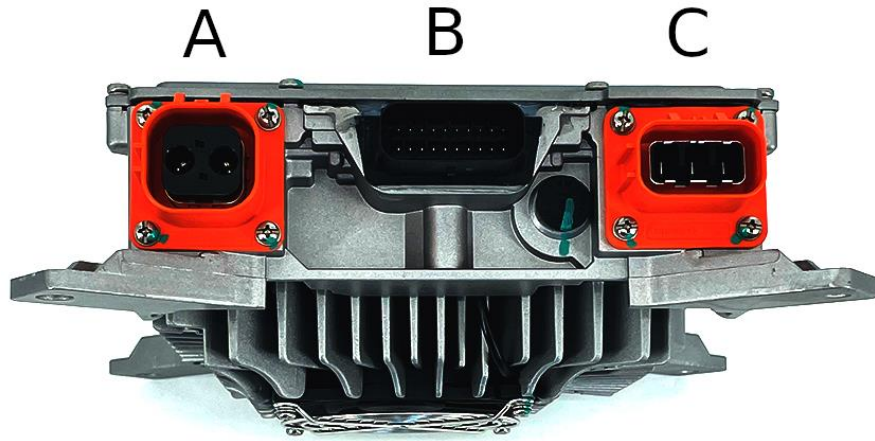

A

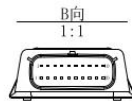

B

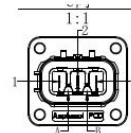

C

HVSI.362022A (SP018022A) 08C Output Terminal
Crimping (Big) :C3100235011 (SP01N45001P)
Crimping (Small) :C310003614 (SP01N12001S)

Brand	Pin	Definition	Wiring Color /Diameter (mm ²)
Ampheonol	1	Positive	Red/8AWG
	2	Negative	Black/8AWG
	A	HVIL Signal 1	Grey/0.5mm ²
	B	HVIL Signal 2	Brown/0.5mm ²

C向

348302001 Signal Terminal

Brand	Pin	Definition	Color/Wiring Diameter (mm ²)
Molex	10	12V5A Output +	/
	11	CANH	
	12	CANL	
	13	HVIL 1	
	14	HVIL 2	
	17	GND	
Others	NC		

HVSI.633023A (SP01A023A) 08C Input Terminal
Crimping (Big) :C310003622 (SP01N63001P)
Crimping (Small) :C310003614 (SP01N12001S)

Brand	Pin	Definition	Wiring Color /Diameter (mm ²)
Ampheonol	1	Null Line (N)	Black/4
	2	Earth Line (PE)	Yellow Green/4
	3	Live Line (L)	RED/4
	A	HVIL Signal 1	Grey/0.5
	B	HVIL Signal 2	Brown/0.5

Installation Requirements – HK-MF-108-32-A Charger



Best installation method



General installation method

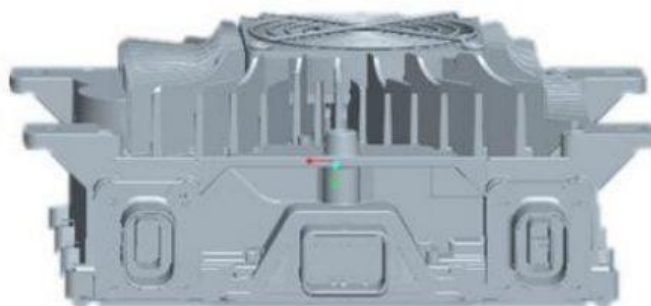

Prohibited installation method

Prohibited installation method is due to the risk of water entering the hole where the fan wire passes into the case.