



DCIS-14412 Series Isolated DC-DC Converter



Overview

The **DCIS-14412** series isolated DC-DC converter is designed to drop EV traction battery voltages to 12V to supply devices such as headlights and audio systems. It features a small form factor, high efficiency, stabilized output voltages, and extensive protection against faults.

DCIS series isolated DC-DC converters are electrically isolated from input to output for enhanced safety. The stabilized output voltage can charge 12V batteries. Multiple DC-DC converters can be used in parallel directly to increase output current.

Specifications

Input Voltage:	144V
Output Voltage:	12V
Max. Output Current:	50A
Maximum Efficiency:	≥88%
Intrusion Protection:	IP65
Operating Temperature:	-20°C-+60°C

Protections & Functions

Water & Vibration Resistance:	Sealed with silicone to withstand moisture in harsh environments
Key Switch Control:	The device can be wired to a key switch or an input relay
Overheat Protection:	Automatic current reduction above 65°C without shutdown
Short Circuit Protection:	Shuts down and resets automatically
Undervoltage Protection:	Shuts down when battery voltage is too low to avoid over-discharge

Connections

- Yellow: Input + (1.5mm²)
- Red : Output + (6.0mm²)
- Grey: Input - (1.5mm²)
- Black: Output - (6.0mm²)
- Green: Key Switch Controls (Option) (0.5 mm²)

Notes

1. Do not switch input and output wires. Incorrect connection will cause damage.
2. Do not open the enclosure of the device as there is risk of electric shock.

Mechanical Dimensions - DCIS-14412 Series DC-DC Converter

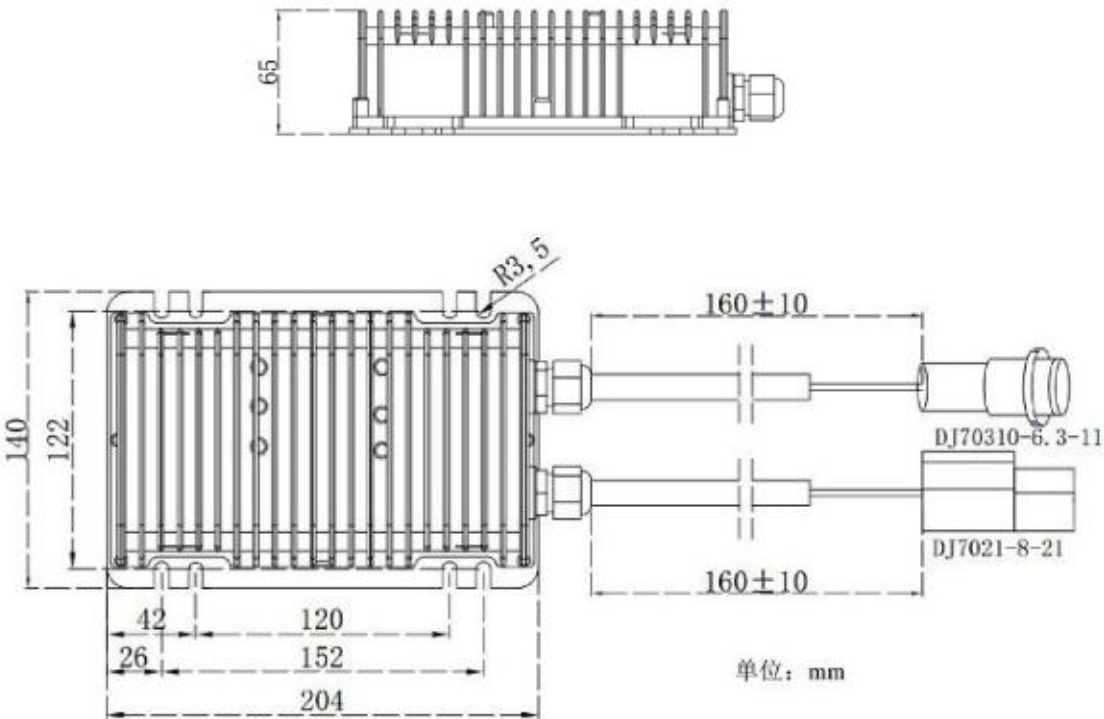

***Interface Description:**

1.Output+	Red	6.0mm ² ;
2.Output-	Black	6.0mm ² ;
3.Key Switch Control(Optional)	Green	0.5mm ² ;
4.Input+	Yellow	1.5mm ² ;
5.Input-	Grey	1.5mm ² ;

Type 2 male/female connectors

Pin Connectors - DCIS-14412 Series DC-DC Converter

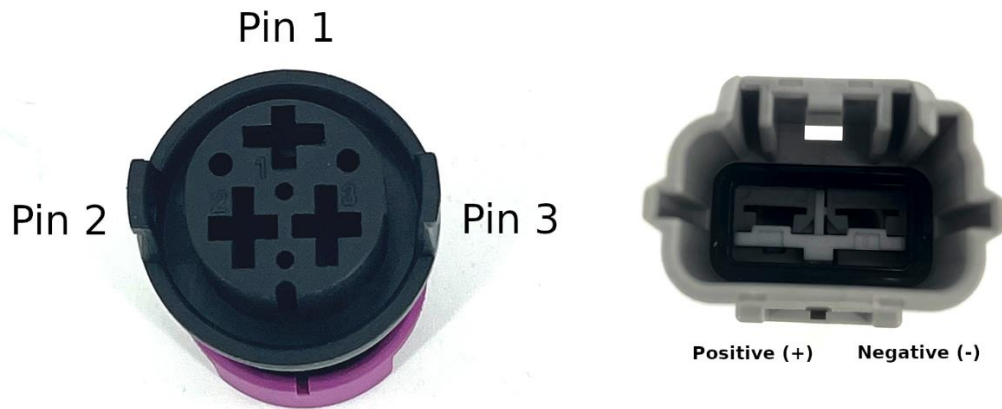

- Pin 1 - Green
- Pin 2 - Grey
- Pin 3 - Yellow

Wiring Diagram - DCIS-4812 Series DC-DC Converter

