

# Dust Extractor

## Dry Use Vacuum System

with Hose Fitting and Wall Mount Accessories



# Operator's Manual

Record the serial number and date of purchase in your manual for future reference.

Serial Number: \_\_\_\_\_ Date of purchase: \_\_\_\_\_

For technical support or parts questions, email [techsupport@rikontools.com](mailto:techsupport@rikontools.com) or call toll free at (877)884-5167

# TABLE OF CONTENTS

Specifications.....	2
Safety Instructions .....	3 - 6, 10
Getting To Know Your Machine .....	7
Contents of Package .....	7 - 8
Assembly .....	8 - 9
Maintenance .....	10 - 11
Parts Diagram.....	12
Parts List .....	13
Electricals & Wiring Diagram .....	5 & 14
Notes .....	14
Accessories .....	15
Warranty .....	15

# SPECIFICATIONS

Motor .....	1.5 HP, 1100W
Volts .....	120 V
Amps, Hertz .....	9.2 A, 60 Hz
Canister Size .....	12 Gallons (45 Liters)
Filtration (Micron) .....	0.5 µm
Sound Level (dB) .....	<95 dB
Dust Port .....	4" Diameter (102 mm)
Dust Collection Velocity .....	142 CFM
Blower Impeller Diameter .....	5" (125 mm)
Blower Impeller Material .....	Steel
Overall Size (LxWxH).....	17" x 15" x 25-1/4" (432 x 381 x 641 mm)
Base Diameter .....	14" (55 mm)
Net Weight .....	24.8 lbs (11.25 kg)

**NOTE:** The specifications, photographs, drawings and information in this manual represent the current model when the manual was prepared. Changes and improvements may be made at any time, with no obligation on the part of RIKON Power Tools, Inc. to modify previously delivered units. Reasonable care has been taken to ensure that the information in this manual is correct, to provide you with the guidelines for the proper safety, assembly and operation of this machine.

# SAFETY INSTRUCTIONS

**IMPORTANT!** Safety is the single most important consideration in the operation of this equipment. **The following instructions must be followed at all times.** Failure to follow all instructions listed below may result in electric shock, fire, and/or serious personal injury.

There are certain applications for which this tool was designed. We strongly recommend that this tool not be modified and/or used for any other application other than that for which it was designed. If you have any questions about its application, do not use the tool until you have contacted us and we have advised you.

## SAFETY SYMBOLS



**SAFETY ALERT SYMBOL:** Indicates DANGER, WARNING, or CAUTION. This symbol may be used in conjunction with other symbols or pictographs.



Indicates an imminently hazardous situation, which, if not avoided, could result in death or serious injury.



Indicates a potentially hazardous situation, which, if not avoided, could result in death or serious injury.



Indicates a potentially hazardous situation, which, if not avoided, could result in minor or moderate injury.

**NOTICE:** Shown without Safety Alert Symbol indicates a situation that may result in property damage.

## GENERAL SAFETY

**KNOW YOUR POWER TOOL.** Read the owner's manual carefully. Learn the tool's applications, work capabilities, and its specific potential hazards.

### BEFORE USING YOUR MACHINE

To avoid serious injury and damage to the tool, read and follow all of the Safety and Operating Instructions before operating the machine.

1. Some dust created by using power tools contains chemicals known to the State of California to cause cancer, birth defects, or other reproductive harm.

Some examples of these chemicals are:

- Lead from lead-based paints.
- Crystalline silica from bricks, cement, and other masonry products.
- Arsenic and chromium from chemically treated lumber.

Your risk from these exposures varies, depending on how often you do this type of work. To reduce your exposure to these chemicals: work in a well ventilated area and work with approved safety equipment, such as those dust masks that are specially designed to filter out microscopic particles.

2. **READ** the entire Owner's Manual. **LEARN** how to use the tool for its intended applications.

3. **GROUND ALL TOOLS.** If the tool is supplied with a 3 prong plug, it must be plugged into a 3-contact electrical receptacle. The 3rd prong is used to ground the tool and provide protection against accidental electric shock. **DO NOT** remove the 3rd prong. See Grounding Instructions on the following pages.

4. **AVOID A DANGEROUS WORKING ENVIRONMENT.** **DO NOT** use electrical tools in a damp environment or expose them to rain.

5. **DO NOT** use electrical tools in the presence of flammable liquids or gasses.

6. **ALWAYS** keep the work area clean, well lit, and organized. **DO NOT** work in an environment with floor surfaces that are slippery from debris, grease, and wax.

7. **KEEP VISITORS AND CHILDREN AWAY. DO NOT** permit people to be in the immediate work area, especially when the electrical tool is operating.

8. **DO NOT FORCE THE TOOL** to perform an operation for which it was not designed. It will do a safer and higher quality job by only performing operations for which the tool was intended.

9. **WEAR PROPER CLOTHING. DO NOT** wear loose clothing, gloves, neckties, or jewelry. These items can get caught in the machine during operations and pull the operator into the moving parts. The user must wear a protective cover on their hair, if the hair is long, to prevent it from contacting any moving parts.

10. **CHILDPROOF THE WORKSHOP AREA** by removing switch keys, unplugging tools from the electrical receptacles, and using padlocks.

11. **ALWAYS UNPLUG THE TOOL FROM THE ELECTRICAL RECEPTACLE** when making adjustments, changing parts or performing any maintenance.

# SAFETY INSTRUCTIONS

**12. KEEP PROTECTIVE GUARDS IN PLACE AND IN WORKING ORDER.**

**13. AVOID ACCIDENTAL STARTING.** Make sure that the power switch is in the “OFF” position before plugging in the power cord to the electrical receptacle.

**14. REMOVE ALL MAINTENANCE TOOLS** from the immediate area prior to turning “ON” the machine.

**15. USE ONLY RECOMMENDED ACCESSORIES.** Use of incorrect or improper accessories could cause serious injury to the operator and cause damage to the tool. If in doubt, check the instruction manual that comes with that particular accessory.

**16. NEVER LEAVE A RUNNING TOOL UNATTENDED.** Turn the power switch to the “OFF” position. **DO NOT** leave the tool until it has come to a complete stop.

**17. DO NOT STAND ON A TOOL.** Serious injury could result if the tool tips over, or you accidentally contact the tool.

**18. DO NOT** store anything above or near the tool where anyone might try to stand on the tool to reach it.

**19. MAINTAIN YOUR BALANCE. DO NOT** extend yourself over the tool. Wear oil resistant rubber soled shoes. Keep floor clear of debris, grease, and wax.

**20. MAINTAIN TOOLS WITH CARE.** Always keep tools clean and in good working order. Keep all blades and tool bits sharp, dress grinding wheels and change other abrasive accessories when worn.

**21. EACH AND EVERY TIME, CHECK FOR DAMAGED PARTS PRIOR TO USING THE TOOL.** Carefully check all guards to see that they operate properly, are not damaged, and perform their intended functions. Check for alignment, binding or breaking of moving parts. A guard or other part that is damaged should be immediately repaired or replaced.

**22. DO NOT OPERATE TOOL WHILE TIRED, OR UNDER THE INFLUENCE OF DRUGS, MEDICATION OR ALCOHOL.**

**23. SECURE ALL WORK.** Use clamps or jigs to secure the workpiece. This is safer than attempting to hold the workpiece with your hands.

**24. STAY ALERT, WATCH WHAT YOU ARE DOING, AND USE COMMON SENSE WHEN OPERATING A POWER TOOL.**

A moment of inattention while operating power tools may result in serious personal injury.

**25. ALWAYS WEAR A DUST MASK TO PREVENT INHALING DANGEROUS DUST OR AIRBORNE PARTICLES,** including wood dust, crystalline silica dust and asbestos dust. Direct particles away from face and body. Always operate tool in well ventilated area and provide for proper dust removal. Use dust collection system wherever possible. Exposure to the dust may cause serious and permanent respiratory or other injury, including silicosis (a serious lung disease), cancer, and death. Avoid breathing the dust, and avoid prolonged contact with dust. Allowing dust to get into your mouth or eyes, or lay on your skin may promote absorption of harmful material. Always use properly fitting NIOSH/OSHA approved respiratory protection appropriate for the dust exposure, and wash exposed areas with soap and water.

**26. USE A PROPER EXTENSION CORD IN GOOD CONDITION.** When using an extension cord, be sure to use one heavy enough to carry the current your product will draw. The table on the following page shows the correct size to use depending on cord length and nameplate amperage rating. If in doubt, use the next heavier gauge. The smaller the gauge number, the larger diameter of the extension cord. If in doubt of the proper size of an extension cord, use a shorter and thicker cord. An undersized cord will cause a drop in line voltage resulting in a loss of power and overheating.  
**USE ONLY A 3-WIRE EXTENSION CORD THAT HAS A 3-PRONG GROUNDING PLUG AND A 3-POLE RECEPTACLE THAT ACCEPTS THE TOOL’S PLUG.**

**27. ADDITIONAL INFORMATION** regarding the safe and proper operation of this product is available from:

- Power Tool Institute  
1300 Summer Avenue  
Cleveland, OH 44115-2851  
[www.powertoolinstitute.org](http://www.powertoolinstitute.org)
- National Safety Council  
1121 Spring Lake Drive  
Itasca, IL 60143-3201  
[www.nsc.org](http://www.nsc.org)
- American National Standards Institute  
25 West 43rd Street, 4th Floor  
New York, NY 10036  
[www.ansi.org](http://www.ansi.org)
- ANSI 01.1 Safety Requirements for Woodworking Machines and the U.S. Department of Labor regulations  
[www.osha.gov](http://www.osha.gov)

**28. SAVE THESE INSTRUCTIONS.** Refer to them frequently and use them to instruct others.

# SAFETY INSTRUCTIONS

## ELECTRICAL SAFETY

**⚠ WARNING:** THIS 120V TOOL MUST BE GROUND-ED WHILE IN USE TO PROTECT THE OPERATOR FROM ELECTRIC SHOCK.

**IN THE EVENT OF A MALFUNCTION OR BREAKDOWN,** grounding provides the path of least resistance for electric current and reduces the risk of electric shock. This tool is equipped with an electric cord that has an equipment grounding conductor and requires a grounding plug (not included). The plug **MUST** be plugged into a matching electrical receptacle that is properly installed and grounded in accordance with **ALL** local codes and ordinances.

**DO NOT MODIFY ANY PLUG.** If it will not fit the electrical receptacle, have the proper electrical receptacle installed by a qualified electrician.

**IMPROPER ELECTRICAL CONNECTION** of the equipment grounding conductor can result in risk of electric shock. The conductor with the green insulation (with or without yellow stripes) is the equipment grounding conductor. **DO NOT** connect the equipment grounding conductor to a live terminal if repair or replacement of the electric cord or plug is necessary.

**CHECK** with a qualified electrician or service personnel if you do not completely understand the grounding instructions, or if you are not sure the tool is properly grounded when installing or replacing a plug.

**USE ONLY A 3-WIRE EXTENSION CORD THAT HAS THE PROPER TYPE OF A 3-PRONG GROUNDING PLUG THAT MATCHES THE MACHINE'S 3-PRONG PLUG AND ALSO THE 3-POLE RECEPTACLE THAT ACCEPTS THE TOOL'S PLUG. \***

**REPLACE A DAMAGED OR WORN CORD IMMEDIATELY.**

This tool is intended for use on a circuit that has an electrical receptacle as shown in **FIGURE A**. It shows a 3-wire electrical plug and electrical receptacle that has a grounding conductor. If a properly grounded electrical receptacle is not available, an adapter as shown in **FIGURE B** can be used to temporarily connect this plug to a 2-contact ungrounded receptacle. The adapter has a rigid lug extending from it that **MUST** be connected to a permanent earth ground, such as a properly grounded receptacle box. **THIS ADAPTER IS PROHIBITED IN CANADA.**

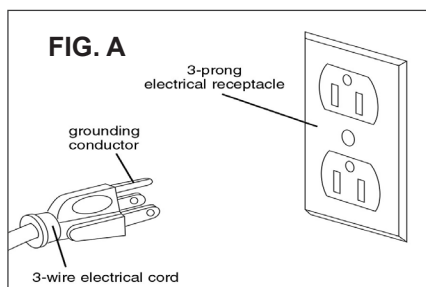

## EXTENSION CORDS

**⚠ WARNING:** THE USE OF AN EXTENSION CORD WITH THIS MACHINE IS NOT RECOMMENDED. For best power and safety, plug the machine directly into a dedicated, grounded electrical outlet that is within the supplied cord length of the machine.

If an extension cord needs to be used, it should only be for a limited operation of the machine. The extension cord should be as short as possible in length, and have a minimum gauge size of 14AWG.

**⚠ WARNING:** Check extension cords before each use. If damaged replace immediately. Never use a tool with a damaged cord, since touching the damaged area could cause electrical shock, resulting in serious injury.

Use a proper extension cord. Only use cords listed by Underwriters Laboratories (UL). Other extension cords can cause a drop in line voltage, resulting in a loss of power and overheating of tool. When operating a power tool outdoors, use an outdoor extension cord marked "W-A" or "W". These cords are rated for outdoor use and reduce the risk of electric shock.

### MINIMUM RECOMMENDED GAUGE FOR EXTENSION CORDS (AWG)

120 VOLT OPERATION ONLY				
	25' LONG	50' LONG	100' LONG	150' LONG
0 to 6 Amps	18 AWG	16 AWG	16 AWG	14 AWG
6 to 10 Amps	18 AWG	16 AWG	14 AWG	12 AWG
10 to 12 Amps	16 AWG	16 AWG	14 AWG	12 AWG

**⚠ WARNING:** Keep the extension cord clear of the working area. Position the cord so that it will not get caught on lumber, tools or other obstructions while you are working with your power tool.

\* Canadian electrical codes require extension cords to be certified SJT type or better.

\*\* The use of an adapter in Canada is not acceptable.

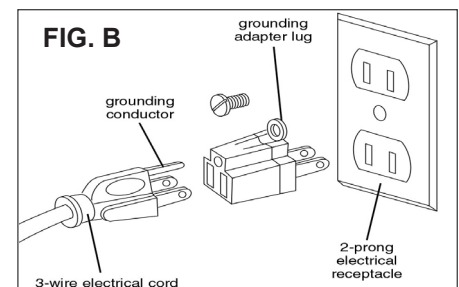

# SAFETY INSTRUCTIONS

The 63-110 Dust Extractor is a DRY USE ONLY vacuum system. It is NOT to be used for water clean-up. Any use beyond its intended purpose could cause failure or injury, and will void any written or implied warranty.

## SPECIFIC SAFETY INSTRUCTIONS FOR DUST COLLECTORS

1. Do not operate this machine until you have read all of the following instructions.
2. Do not attempt to operate this machine until it is completely assembled.
3. Do not turn ON this machine if any pieces are missing.
4. This machine must be properly grounded.
5. If you are not familiar with the operation of the machine, obtain assistance from a qualified person.
6. It is highly recommended that this machine be placed on a level surface.
7. Always wear approved, safety protective eye wear and hearing protection when operating this machine.
8. Always wear a dust mask when cleaning or working near a dust collector.
9. Do not wear loose clothing or jewelry when operating this machine. Keep long hair tied back.
10. Do not wear any gloves while operating this machine.
11. Do not operate this machine if you are under the influence of drugs and/or alcohol.
12. Always make sure the power switch is in the OFF position prior to plugging in the machine.
13. Always make sure the power switch is in the OFF position and the machine is unplugged when doing any cleaning, assembly, setup operation, or when not in use.
14. Do not place the Collector near an open ignition source - open flames, pilot lights, or grinding areas producing sparks.
15. Do not expose the Collector to rain or dampness.
16. Use the Collector for filtering wood dust only. Not for use filtering sheet rock dust, silica, lead paint dust, asbestos, biohazards, smoke, toxic fumes, spray paint or flammable liquids.
17. Do not use without filters in place.
18. Do not leave the machine running unattended.
19. If the hose becomes blocked with debris, turn off the Collector immediately to prevent any motor damage.  
Unplug the machine before removing the blockage in the hose.
20. The use of accessories or attachments not recommended may cause injury to you and damage your machine.
21. Always keep your face and hands clear of moving parts such as impellers and fans.

## SAVE THESE INSTRUCTIONS

Refer to them often.

**This owner's manual is not a teaching aid and is intended to show assembly, adjustments, and general use.**

**CALIFORNIA PROPOSITION 65 WARNING:** Some dust created by power sanding, sawing, grinding, drilling, and other construction activities contains chemicals known to the State of California to cause cancer and birth defects or other reproductive harm. Your risk from exposure to these chemicals varies, depending on how often you do this type of work. To reduce your exposure, work in a well-ventilated area and with approved safety equipment, such as dust masks that are specially designed to filter out microscopic particles.

For more detailed information about California Proposition 65 log onto [rikontools.com](http://rikontools.com).



## GETTING TO KNOW YOUR MACHINE

### DUST EXTRACTOR PARTS

- A. Handle
- B. On / Off Safety Switch
- C. Motor Cover / Lid
- D. Dust Hose Inlet
- E. Hose Clamp (2)
- F. Dust Hose - 4" Diameter
- G. Band Strap Clamp
- H. Canister Body - 12 Gallons
- I. Hose Connector Fitting
- J. Hose Adapter Fittings (4)
- K. Wall Mount Brackets

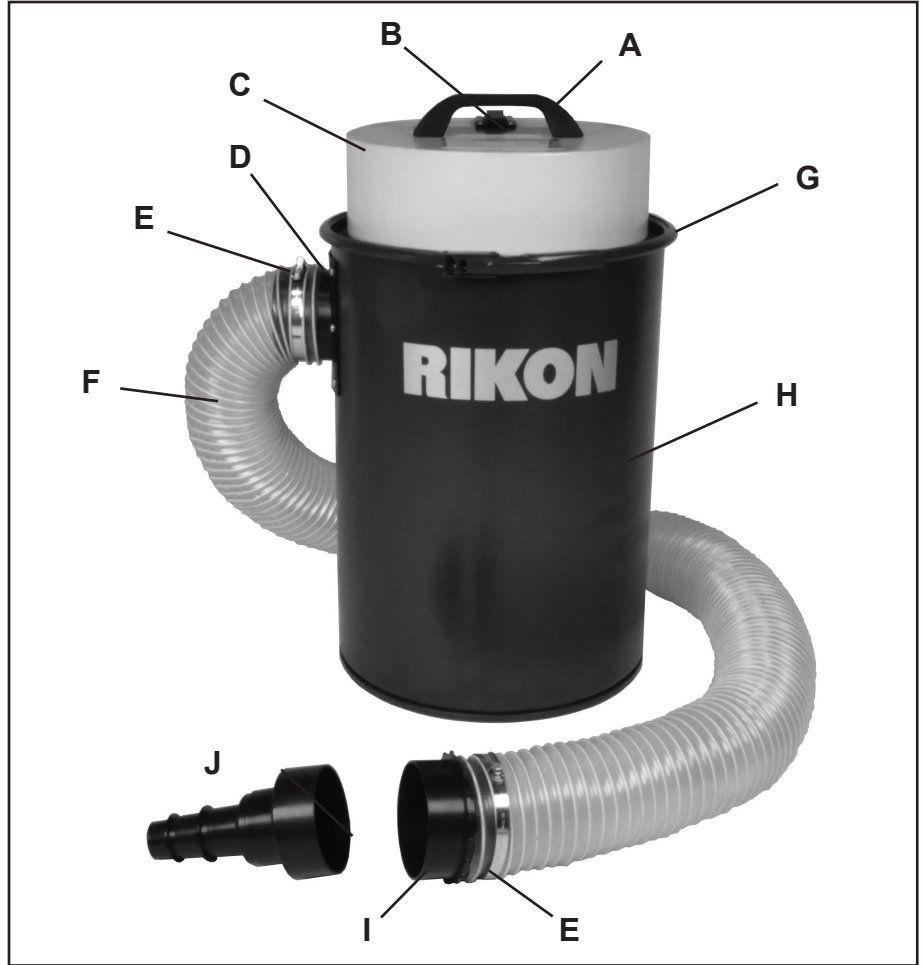
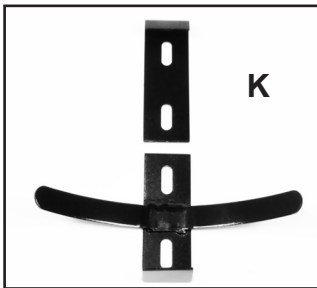

### CONTENTS OF PACKAGE

Model 63-110 Dust Extractor is shipped complete in one box.

#### Unpacking and Clean-up

1. Carefully remove all contents from the shipping carton. Compare the contents with the list of contents to make sure that all of the items are accounted for, before discarding any packing material. Place parts on a protected surface for easy identification and assembly. If any parts are missing or broken, please call RIKON Customer Service (877- 884-5167) as soon as possible for replacements. DO NOT turn your machine ON if any of these items are missing. You may cause injury to yourself or damage to the machine.

2. Report any shipping damage to your local distributor. Take photographs for any possible insurance claims.

3. Clean any rust protected surfaces with ordinary household type grease or spot remover. Do not use; gasoline, paint thinner, mineral spirits, etc. These may damage painted surfaces.

4. Set packing material and shipping carton aside. Do not discard until the machine has been set up and is running properly.

# CONTENTS OF PACKAGE

## LIST OF LOOSE PARTS

- A. Canister Body
- B. Band Strap Clamp
- C. Paper Filter Bag & Cartridge Filter
- D. Motor Lid Assembly
- E. Dust Hose - 4" Diameter
- F. Paper Filter Bags (4)
- G. Hose Clamps (2)
- H. Handle & Screws (2)
- I. Hex Wrench - 4mm
- J. Hose Connector Fitting
- K. Hose Fittings Set (4)
- L. Wall Mounting Brackets
- M. Manual (Not Shown)

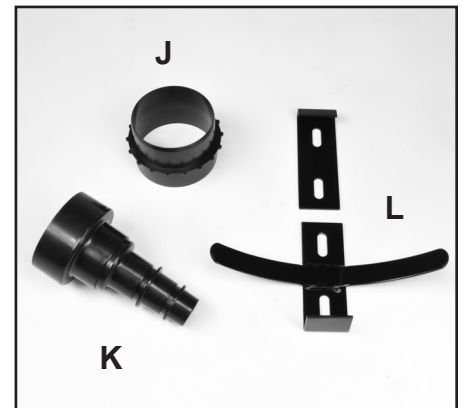
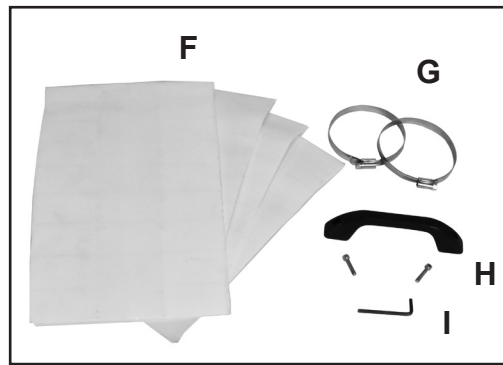
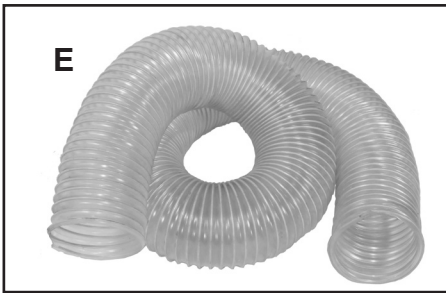
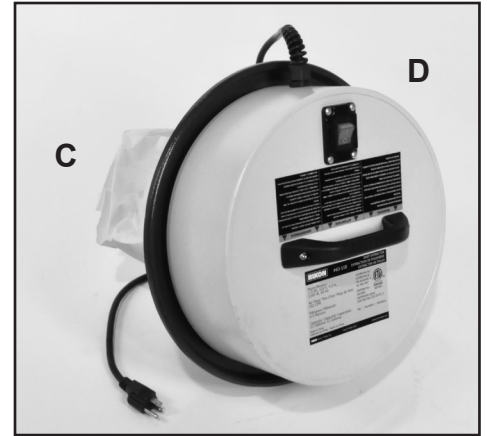

## ASSEMBLY



### WARNING

THE MACHINE MUST NOT BE PLUGGED IN AND THE POWER SWITCH MUST BE IN THE 'OFF' POSITION UNTIL ASSEMBLY IS COMPLETE.

### Tools Required for Assembly

- Slotted Screwdriver



### WARNING

The 63-110 Dust Extractor is a DRY USE ONLY vacuum system. It is NOT to be used for water clean-up. Any use beyond its intended purpose could cause failure or injury, and will void any written or implied warranty.

## ASSEMBLY OF DUST EXTRACTOR

1. Place the cartridge filter with open end facing up, inside of a paper filter bag. FIG. 1.

**NOTE:** The paper filter may already be pre-assembled onto the cartridge filter. If this is the case, please go to Step 4 of the assembly instructions to continue the assembly process.

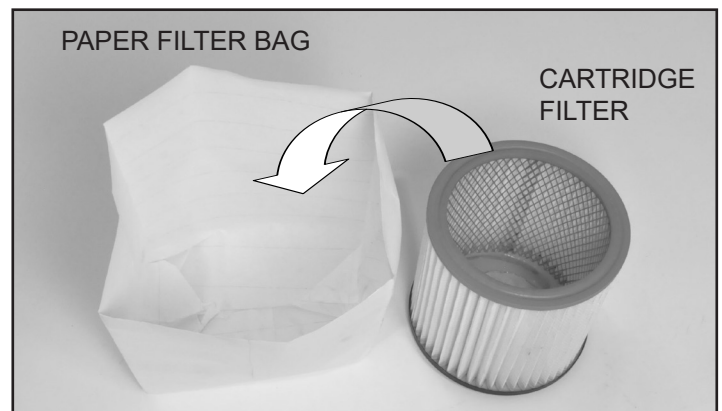

FIG. 1



## ASSEMBLY

2. Fold the top edges of the paper filter bag down inside of the cartridge filter. FIG. 2.

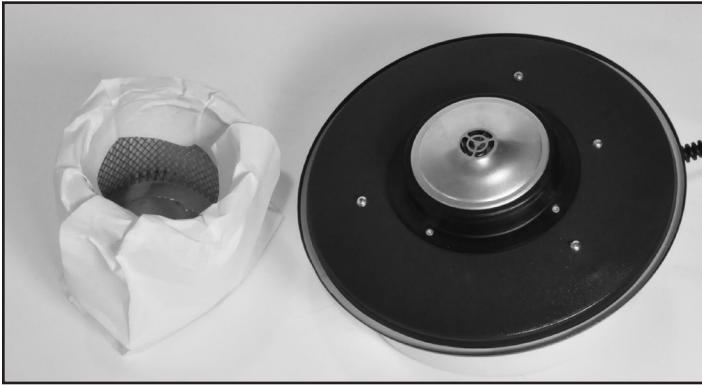

FIG. 2

3. Push the filter assembly down onto the motor body, making sure it is fully seated and secure. FIG. 3.

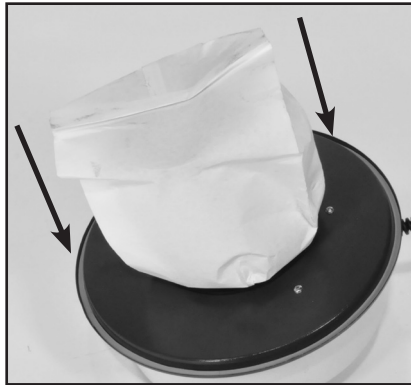

FIG. 3

4. Lift and install the lid and filter assembly on top of the canister body. Secure the lid to the body with the band strap clamp. FIG. 4.

5. Attach one end of the flexible 4" dust hose to the machine's Dust Inlet, and secure it in place with the hose clamp supplied. FIG. 4.



FIG. 4

6. The free end of the 4" hose can be clamped to any machine with a 4" outlet for dust collection. A 4" fitting and set of 4 different size fittings is supplied for connecting the hole to machines with smaller diameter outlets. See page 8.

7. Wall Brackets are included for hanging the Dust Extractor on a wall next to a stationary machine, work area, or just as a storage spot when the Dust Extractor is not in use. To install the mounting brackets, a solid wall is required for full support of the machine.

- Lift the Dust Extractor against the wall to find the height / location you need for the collector.
- Place a mark on the wall where the collector's lid or band strap clamp touches the wall.
- Screw or bolt the top bracket to the wall's stud at this spot. (fasteners not included). The curved end of the bracket should be on top - like an upside-down 'J'.
- With the help of a second person, lift the dust canister so that its raised lid edge is positioned in the top bracket's curved end.
- Position the bottom bracket (with the side wings) under the canister bottom, so that the bottom edge of the bracket supports the canister. Mark the location of the bracket on the wall, remove the canister, and fasten the lower bracket to the wall.
- To position the Extractor in the brackets, lift and insert the canister's lid into the top bracket, then pivot the bottom of the canister onto the lower bracket.

FIG. 5

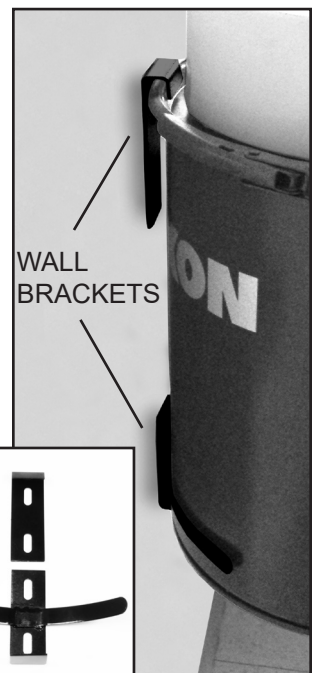

**NOTE:** Position the canister with the dust hose running along the wall and not straight out from the wall. This will help prevent the collector from being pulled off of the brackets if the hose is stretched or pulled to a machine.

# MAINTENANCE

## IMPORTANT TIPS ON USE:

- The 4" dust hose is intended mainly for connection to woodworking machinery to collect dry sawdust and shavings. It is not to be used for water clean-up.
- Always ensure that the end of the 4" diameter flexible hose is not completely covered or blocked, or the machine may be 'pulled' suddenly towards the end of the hose.
- Completely covering or blocking the end of the 4" dust hose will restrict airflow to the motor, which may result in overheating and damage to the motor. In addition, the increased pressure may cause damage to the canister body.
- If the 4" dust hose is used for cleaning machinery or around the shop, make sure that the opening is held at an angle to the surface to be cleaned. Do not allow the hose to get stuck to the surface that is being cleaned.

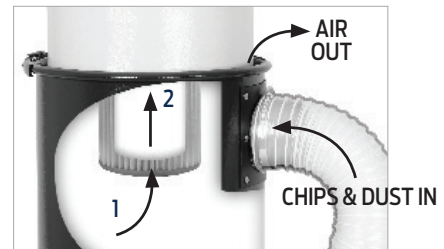

*Two Stage Filtration with Cartridge & Filter Bag*

## INSPECTING THE FILTERS

The filters should be inspected every time the dust collector canister is emptied, and particularly if any reduction in performance is noted. The paper filter traps fine dust, and to prevent becoming clogged should be replaced regularly. The cartridge filter should be cleaned at the same time, and should be replaced annually, or whenever it shows signs of damage, or wear.

## CHANGING THE FILTERS

1. Remove the lid and filter assembly, and lay the lid on a flat surface.
2. Slide the paper bag filter and cartridge filter off of the motor assembly as one unit. FIG. 6.

**NOTE: Care should be taken when handling soiled or contaminated filter bags and cartridges, as certain fine dusts can be harmful. Always wear a suitable dust mask for additional protection.**

3. Remove the paper bag from around the cartridge filter and dispose.
4. The cartridge filter can be carefully cleaned with a vacuum cleaner, or replaced, if needed.
5. To replace the filters, follow steps 1-3 outlined on pages 8 and 9. FIGs. 1-3. FIG. 7.
6. Replace the lid with new filters back onto the canister body, and secure it in place with the Band Strap Clamp. See page 9, step #4.

**NOTE:** See page 14 for replacement filter information.

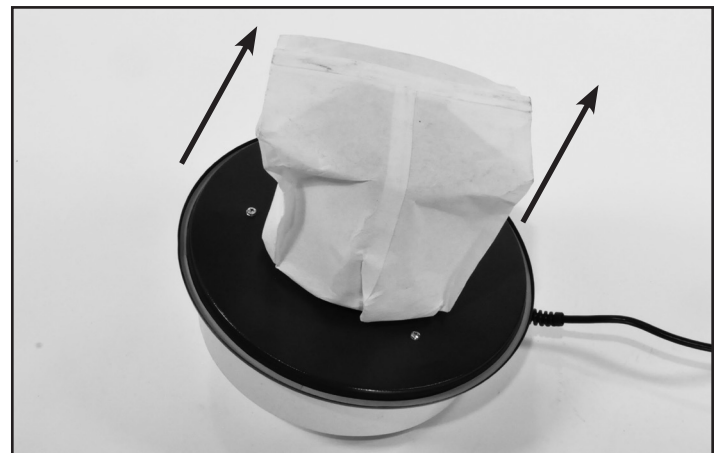

**FIG. 6**

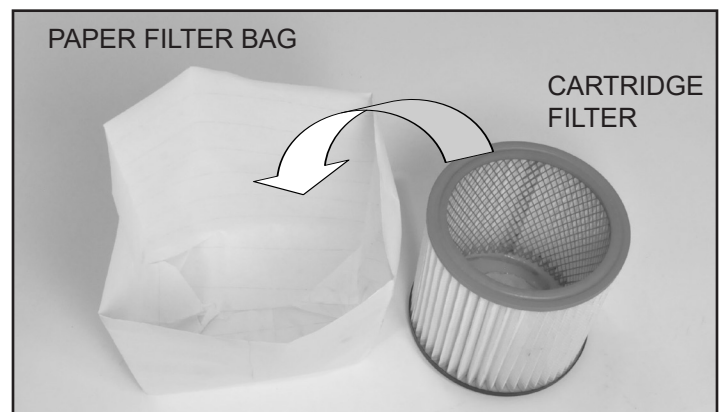

**FIG. 7**

# MAINTENANCE



**WARNING**

**THE MACHINE MUST NOT BE PLUGGED IN AND THE POWER SWITCH MUST BE IN THE 'OFF' POSITION UNTIL ASSEMBLY IS COMPLETE.**

## Tools Required for Service

- #2 Phillips Screwdriver

## REPLACING MOTOR BRUSHES

The motor's carbon brushes should not need replacing for at least 2,000 hours. These brushes are located on the motor housing which is fastened under the extractor's top lid.

1. Before installing new carbon brushes, first ensure that the machine is switched off and disconnected from the power supply.
2. Remove the motor cover from the top lid of the machine by unscrewing the three Phillips-head screws holding it in place. Slide the lid cover off to gain access to the inside of the motor and motor housing. FIG. 8.
3. Locate the areas on the motor where the two carbon brush carriers are located. FIG. 9.
4. Remove the brush carrier assembly from the motor housing by unscrewing the Phillips head screw that holds it in place. FIG. 10 & 11.
5. Install the new brush carrier assembly (part #11B) into the same position on the motor housing with the Phillips head screw that was removed in step 4.
6. Re-attach the motor cover to the lid, position the lid on the canister body, and secure it in place with the band strap clamp. The Dust Extractor is again ready for use.

**NOTE:** When replacing motor brushes, take care not to allow dust, oil, water, etc. to get into the motor. Make sure that all screws and fasteners are properly installed and secured before using the Dust Extractor.

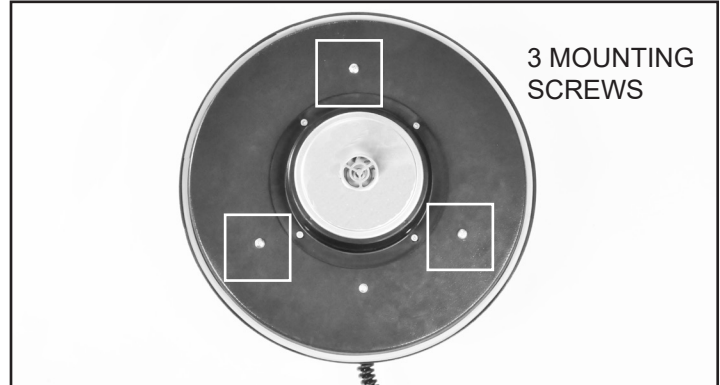

**FIG. 8**



**FIG. 9**

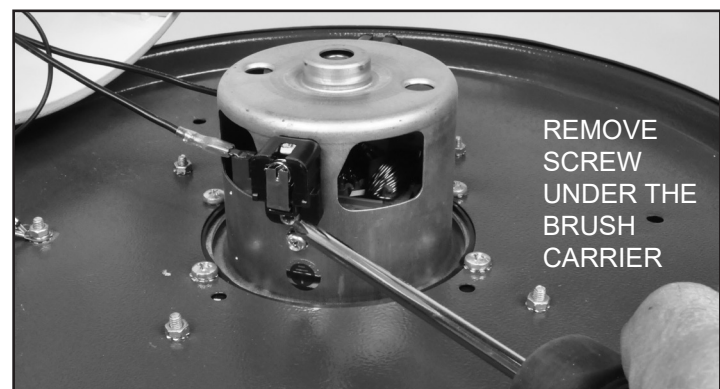

**FIG. 10**

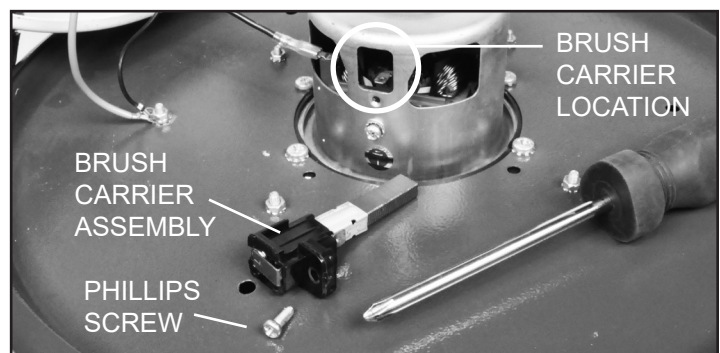

**FIG. 11**

# PARTS DIAGRAM

## DUST EXTRACTOR #63-110

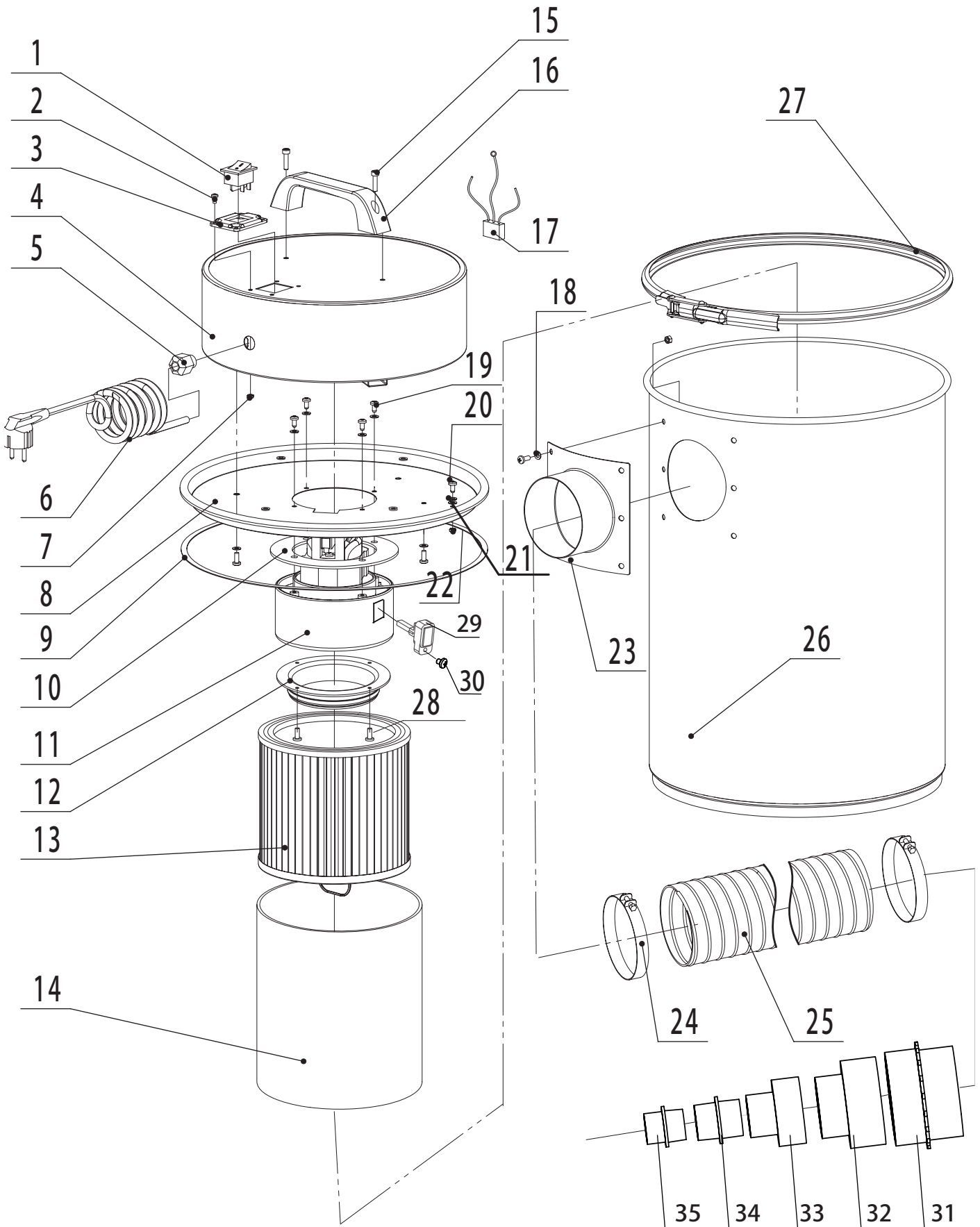



# PARTS LIST

## DUST EXTRACTOR #63-110

KEY NO.	DESCRIPTION	QTY.	MFG. PART NO.
1	Switch	1	P63-100-1
2	Pan Head Screw M4X10	4	P63-100-2
3	Switch Mounting Plate	1	P63-100-3
4	Lid Cover	1	P63-100-4
5	M16 Strain Release	1	P63-100-5
6	Power Cord	1	P63-100-6
7	Hex Nut M4	4	P63-100-7
8	Lid	1	P63-110-8
9	Packing Washer	2	P63-100-9
10	Motor Packing Washer	1	P63-100-10
11	Motor Assembly	1	P63-110-11
11B	Motor Brush Assembly (not shown)	1	P63-110-11B
12	Cartridge Packing Washer	1	P63-110-12
13	Filter Cartridge Assembly	1	P63-100-13
14	Filter Bag	5	P63-100-14
15	Hex Head Screw M5x25	2	P63-100-15
16	Handle	1	P63-100-16
17	Motor Capacitor	1	P63-100-17
18	Flat Washer	13	P63-100-18
19	Pan Head Screw M5x12	9	P63-110-19
20	Pan Head Screw M4x10	1	P63-110-20
21	Circlip	1	P63-110-21
22	Hex Nut M4	1	P63-110-22
23	4" Dust Inlet	1	P63-100-23
24	4" Hose Clamp	2	P63-100-24
25	Dust Hose 4"x78"	1	P63-100-25
26	Canister Body	1	P63-100-26
27	Band Strap Clamp	1	P63-100-27
28	Flat Head Screw M5x12	4	P63-110-28
29	Motor Brush	2	P63-110-29
30	Pan Head Screw M4x10	2	P63-110-30
31	Hose Connector Fitting - 4"	1	P63-110-31
32	Hose Adapter Fitting 4"/ 2-3/4" OD approx	1	P63-110-32
33	Hose Adapter Fitting 2-1/2"-1-7/8" approx	1	P63-110-33
34	Hose Adapter Fitting 1-5/8"-1-9/16" approx	1	P63-110-34
35	Hose Adapter Fitting 1-3/8"-1-3/8" approx	1	P63-110-35

**NOTE:** Please reference the Manufacturer's Part Number when calling for Replacement Parts. For Parts under Warranty, the Serial Number of your machine is required.





## ACCESSORIES



### 63-900 Mobility Wheel Kit

4 Hard plastic 1-3/4" casters mounted on a steel frame will quickly attach to the bottom of Dust Extractors, allowing easy rolling of the Extractor around the shop to different machines for dust collection, or for general cleaning jobs.

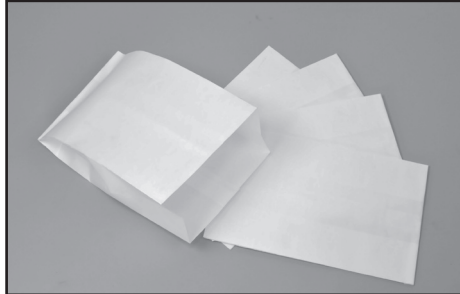

### 63-920 Paper Filter Bags (5 Pk)

Special constructed, 0.015" thick paper bags install over the 63-915 pleated Filter Cartridge for extra filtering of shop dust down to 0.5 microns! Five (5) replacement bags are included.



### 63-915 Filter Cartridge

Canister-type Filter is 7-1/4" diameter x 6-1/2" high and features a pleated filter surrounding a metal frame. The 9/16" pleats allow more air flow and dust particle capture that first passes through the pre-filter bags (63-920).

For ordering parts, please contact your local RIKON Distributor, or call RIKON at 877-884-5167.

## WARRANTY

**RIKON**  
POWER TOOLS®

### 5-Year Limited Warranty

RIKON Power Tools Inc. ("Seller") warrants to only the original retail consumer/purchaser of our products that each product be free from defects in materials and workmanship for a period of five (5) years from the date the product was purchased at retail. This warranty may not be transferred.

This warranty does not apply to defects due directly or indirectly to misuse, abuse, negligence, accidents, repairs, alterations, lack of maintenance or normal wear and tear. Under no circumstances will Seller be liable for incidental or consequential damages resulting from defective products. All other warranties, expressed or implied, whether of merchantability, fitness for purpose, or otherwise are expressly disclaimed by Seller. This five-year warranty does not cover products used for commercial, industrial or educational purposes. The warranty term for these claims will be limited to a two-year period.

This limited warranty does not apply to accessory items such as blades, drill bits, sanding discs, grinding wheels, belts, guide bearings and other related items.

Seller shall in no event be liable for death, injuries to persons or property, or for incidental, contingent, special, or consequential damages arising from the use of our products.

To take advantage of this warranty, proof of purchase documentation must be provided which has the date of purchase and an explanation of the complaint.

The Seller reserves the right to effect at any time, without prior notice, those alterations to parts, fittings, and accessory equipment which they may deem necessary for any reason whatsoever.

To register your machine online, visit RIKON at [www.rikontools.com/warranty](http://www.rikontools.com/warranty)

To take advantage of this warranty, or if you have any questions, please contact us at 877-884-5167 or email [warranty@rikontools.com](mailto:warranty@rikontools.com)



**For more information:  
16 Progress Road  
Billerica, MA 01821**

**877-884-5167 / 978-528-5380  
techsupport@rikontools.com**

