

10" x 18" Mini Lathe



Operator's Manual

Record the serial number and date of purchase in your manual for future reference.

Serial Number: _____ Date of purchase: _____

For technical support or parts questions, email techsupport@rikontools.com or call toll free at (877)884-5167

TABLE OF CONTENTS

Specifications.....	2
Safety Instructions	3 - 6
Getting To Know Your Machine	7
Contents of Package	7 - 8
Installation	8
Assembly	9 - 11
Adjustments.....	11 - 14
Operation	14
Maintenance	15
Electricals & Wiring Diagram	5 & 15
Troubleshooting	16
Accessories	17
Warranty	17
Parts Diagram	18
Parts List	19

SPECIFICATIONS

Motor	1/2 HP, TEFC
Motor Speed (no load).....	1,700 RPM
Volts, Phase	120 V, 1 Ph
Amps, Hertz	3.7 A, 60 Hz
Swing Over Bed	10" (254 mm)
Swing Over Tool Rest Base.....	7-1/4" (184 mm)
Distance Between Centers.....	18" (457 mm)
Speeds	5
Speed Ranges	500, 1175, 1850, 2225, 3200 RPM
Spindle Rotation	Forward Only (C-Clockwise)
Spindle Nose Threading.....	1" x 8 TPI
Headstock Taper	MT-2
Tailstock Taper	MT-2
Hole Through Drive Spindle	3/8" (10 mm)
Hole Through Tailstock	3/8" (10 mm)
Tailstock Ram Travel	1-3/4" (44.5 mm)
Tool Rest Post Diameter	5/8" (15.8 mm)
Overall Size (LxWxH).....	35-1/2" x 10-1/2" x 14-3/4" (902 x 267 x 375 mm)
Cast Base Size (LxW)	29-1/2" x 7-3/8" (749 x 187 mm)
Net Weight	75 lbs. (34 kg)

NOTE: The specifications, photographs, drawings and information in this manual represent the current model when the manual was prepared. Changes and improvements may be made at any time, with no obligation on the part of Rikon Power Tools, Inc. to modify previously delivered units. Reasonable care has been taken to ensure that the information in this manual is correct, to provide you with the guidelines for the proper safety, assembly and operation of this machine.

SAFETY INSTRUCTIONS

IMPORTANT! Safety is the single most important consideration in the operation of this equipment. **The following instructions must be followed at all times.** Failure to follow all instructions listed below may result in electric shock, fire, and/or serious personal injury.

There are certain applications for which this tool was designed. We strongly recommend that this tool not be modified and/or used for any other application other than that for which it was designed. If you have any questions about its application, do not use the tool until you have contacted us and we have advised you.

SAFETY SYMBOLS



SAFETY ALERT SYMBOL: Indicates DANGER, WARNING, or CAUTION. This symbol may be used in conjunction with other symbols or pictographs.



Indicates an imminently hazardous situation, which, if not avoided, could result in death or serious injury.



Indicates a potentially hazardous situation, which, if not avoided, could result in death or serious injury.



Indicates a potentially hazardous situation, which, if not avoided, could result in minor or moderate injury.

NOTICE: Shown without Safety Alert Symbol indicates a situation that may result in property damage.

GENERAL SAFETY

KNOW YOUR POWER TOOL. Read the owner's manual carefully. Learn the tool's applications, work capabilities, and its specific potential hazards.

BEFORE USING YOUR MACHINE

To avoid serious injury and damage to the tool, read and follow all of the Safety and Operating Instructions before operating the machine.

1. Some dust created by using power tools contains chemicals known to the State of California to cause cancer, birth defects, or other reproductive harm.

Some examples of these chemicals are:

- Lead from lead-based paints.
- Crystalline silica from bricks, cement, and other masonry products.
- Arsenic and chromium from chemically treated lumber.

Your risk from these exposures varies, depending on how often you do this type of work. To reduce your exposure to these chemicals: work in a well ventilated area and work with approved safety equipment, such as those dust masks that are specially designed to filter out microscopic particles.

2. **READ** the entire Owner's Manual. **LEARN** how to use the tool for its intended applications.

3. **GROUND ALL TOOLS.** If the tool is supplied with a 3 prong plug, it must be plugged into a 3-contact electrical receptacle. The 3rd prong is used to ground the tool and provide protection against accidental electric shock. **DO NOT** remove the 3rd prong. See Grounding Instructions on the following pages.

4. **AVOID A DANGEROUS WORKING ENVIRONMENT.** **DO NOT** use electrical tools in a damp environment or expose them to rain.

5. **DO NOT** use electrical tools in the presence of flammable liquids or gasses.

6. **ALWAYS** keep the work area clean, well lit, and organized. **DO NOT** work in an environment with floor surfaces that are slippery from debris, grease, and wax.

7. **KEEP VISITORS AND CHILDREN AWAY. DO NOT** permit people to be in the immediate work area, especially when the electrical tool is operating.

8. **DO NOT FORCE THE TOOL** to perform an operation for which it was not designed. It will do a safer and higher quality job by only performing operations for which the tool was intended.

9. **WEAR PROPER CLOTHING. DO NOT** wear loose clothing, gloves, neckties, or jewelry. These items can get caught in the machine during operations and pull the operator into the moving parts. The user must wear a protective cover on their hair, if the hair is long, to prevent it from contacting any moving parts.

10. **CHILDPROOF THE WORKSHOP AREA** by removing switch keys, unplugging tools from the electrical receptacles, and using padlocks.

11. **ALWAYS UNPLUG THE TOOL FROM THE ELECTRICAL RECEPTACLE** when making adjustments, changing parts or performing any maintenance.

SAFETY INSTRUCTIONS

12. KEEP PROTECTIVE GUARDS IN PLACE AND IN WORKING ORDER.

13. AVOID ACCIDENTAL STARTING. Make sure that the power switch is in the “OFF” position before plugging in the power cord to the electrical receptacle.

14. REMOVE ALL MAINTENANCE TOOLS from the immediate area prior to turning “ON” the machine.

15. USE ONLY RECOMMENDED ACCESSORIES. Use of incorrect or improper accessories could cause serious injury to the operator and cause damage to the tool. If in doubt, check the instruction manual that comes with that particular accessory.

16. NEVER LEAVE A RUNNING TOOL UNATTENDED. Turn the power switch to the “OFF” position. **DO NOT** leave the tool until it has come to a complete stop.

17. DO NOT STAND ON A TOOL. Serious injury could result if the tool tips over, or you accidentally contact the tool.

18. DO NOT store anything above or near the tool where anyone might try to stand on the tool to reach it.

19. MAINTAIN YOUR BALANCE. DO NOT extend yourself over the tool. Wear oil resistant rubber soled shoes. Keep floor clear of debris, grease, and wax.

20. MAINTAIN TOOLS WITH CARE. Always keep tools clean and in good working order. Keep all blades and tool bits sharp, dress grinding wheels and change other abrasive accessories when worn.

21. EACH AND EVERY TIME, CHECK FOR DAMAGED PARTS PRIOR TO USING THE TOOL. Carefully check all guards to see that they operate properly, are not damaged, and perform their intended functions. Check for alignment, binding or breaking of moving parts. A guard or other part that is damaged should be immediately repaired or replaced.

22. DO NOT OPERATE TOOL WHILE TIRED, OR UNDER THE INFLUENCE OF DRUGS, MEDICATION OR ALCOHOL.

23. SECURE ALL WORK. Use clamps or jigs to secure the work piece. This is safer than attempting to hold the work piece with your hands.

24. STAY ALERT, WATCH WHAT YOU ARE DOING, AND USE COMMON SENSE WHEN OPERATING A POWER TOOL.

A moment of inattention while operating power tools may result in serious personal injury.

25. ALWAYS WEAR A DUST MASK TO PREVENT INHALING DANGEROUS DUST OR AIRBORNE PARTICLES, including wood dust, crystalline silica dust and asbestos dust. Direct particles away from face and body. Always operate tool in well ventilated area and provide for proper dust removal. Use dust collection system wherever possible. Exposure to the dust may cause serious and permanent respiratory or other injury, including silicosis (a serious lung disease), cancer, and death. Avoid breathing the dust, and avoid prolonged contact with dust. Allowing dust to get into your mouth or eyes, or lay on your skin may promote absorption of harmful material. Always use properly fitting NIOSH/OSHA approved respiratory protection appropriate for the dust exposure, and wash exposed areas with soap and water.

26. USE A PROPER EXTENSION CORD IN GOOD CONDITION. When using an extension cord, be sure to use one heavy enough to carry the current your product will draw. The table on the following page shows the correct size to use depending on cord length and nameplate amperage rating. If in doubt, use the next heavier gauge. The smaller the gauge number, the larger diameter of the extension cord. If in doubt of the proper size of an extension cord, use a shorter and thicker cord. An undersized cord will cause a drop in line voltage resulting in a loss of power and overheating.
USE ONLY A 3-WIRE EXTENSION CORD THAT HAS A 3-PRONG GROUNDING PLUG AND A 3-POLE RECEPTACLE THAT ACCEPTS THE TOOL’S PLUG.

27. ADDITIONAL INFORMATION regarding the safe and proper operation of this product is available from:

- Power Tool Institute
1300 Summer Avenue
Cleveland, OH 44115-2851
www.powertoolinstitute.org
- National Safety Council
1121 Spring Lake Drive
Itasca, IL 60143-3201
www.nsc.org
- American National Standards Institute
25 West 43rd Street, 4th Floor
New York, NY 10036
www.ansi.org
- ANSI 01.1 Safety Requirements for Woodworking Machines and the U.S. Department of Labor regulations
www.osha.gov

28. SAVE THESE INSTRUCTIONS. Refer to them frequently and use them to instruct others.

SAFETY INSTRUCTIONS

ELECTRICAL SAFETY

⚠ WARNING: THIS TOOL MUST BE GROUNDED WHILE IN USE TO PROTECT THE OPERATOR FROM ELECTRIC SHOCK.

IN THE EVENT OF A MALFUNCTION OR BREAKDOWN, grounding provides the path of least resistance for electric current and reduces the risk of electric shock. This tool is equipped with an electric cord that has an equipment grounding conductor and requires a grounding plug (not included). The plug **MUST** be plugged into a matching electrical receptacle that is properly installed and grounded in accordance with **ALL** local codes and ordinances.

DO NOT MODIFY ANY PLUG. If it will not fit the electrical receptacle, have the proper electrical receptacle installed by a qualified electrician.

IMPROPER ELECTRICAL CONNECTION of the equipment grounding conductor can result in risk of electric shock. The conductor with the green insulation (with or without yellow stripes) is the equipment grounding conductor. **DO NOT** connect the equipment grounding conductor to a live terminal if repair or replacement of the electric cord or plug is necessary.

CHECK with a qualified electrician or service personnel if you do not completely understand the grounding instructions, or if you are not sure the tool is properly grounded when installing or replacing a plug.

USE ONLY A 3-WIRE EXTENSION CORD THAT HAS THE PROPER TYPE OF A 3-PRONG GROUNDING PLUG THAT MATCHES THE MACHINE'S 3-PRONG PLUG AND ALSO THE 3-POLE RECEPTACLE THAT ACCEPTS THE TOOL'S PLUG. *

REPLACE A DAMAGED OR WORN CORD IMMEDIATELY.

This tool is intended for use on a circuit that has an electrical receptacle as shown in **FIGURE A**. It shows a 3-wire electrical plug and electrical receptacle that has a grounding conductor. If a properly grounded electrical receptacle is not available, an adapter as shown in **FIGURE B** can be used to temporarily connect this plug to a 2-contact ungrounded receptacle. The adapter has a rigid lug extending from it that **MUST** be connected to a permanent earth ground, such as a properly grounded receptacle box. **THIS ADAPTER IS PROHIBITED IN CANADA.**

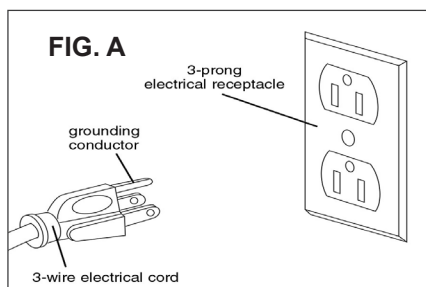

EXTENSION CORDS

⚠ WARNING: THE USE OF AN EXTENSION CORD WITH THIS MACHINE IS NOT RECOMMENDED. For best power and safety, plug the machine directly into a dedicated, grounded electrical outlet that is within the supplied cord length of the machine.

If an extension cord needs to be used, it should only be for a limited operation of the machine. The extension cord should be as short as possible in length, and have a minimum gauge size of 14AWG.

⚠ WARNING: Check extension cords before each use. If damaged replace immediately. Never use a tool with a damaged cord, since touching the damaged area could cause electrical shock, resulting in serious injury.

Use a proper extension cord. Only use cords listed by Underwriters Laboratories (UL). Other extension cords can cause a drop in line voltage, resulting in a loss of power and overheating of tool. When operating a power tool outdoors, use an outdoor extension cord marked "W-A" or "W". These cords are rated for outdoor use and reduce the risk of electric shock.

MINIMUM RECOMMENDED GAUGE FOR EXTENSION CORDS (AWG)

120 VOLT OPERATION ONLY				
	25' LONG	50' LONG	100' LONG	150' LONG
0 to 6 Amps	18 AWG	16 AWG	16 AWG	14 AWG
6 to 10 Amps	18 AWG	16 AWG	14 AWG	12 AWG
10 to 12 Amps	16 AWG	16 AWG	14 AWG	12 AWG

⚠ WARNING: Keep the extension cord clear of the working area. Position the cord so that it will not get caught on lumber, tools or other obstructions while you are working with your power tool.

* Canadian electrical codes require extension cords to be certified SJT type or better.

** The use of an adapter in Canada is not acceptable.

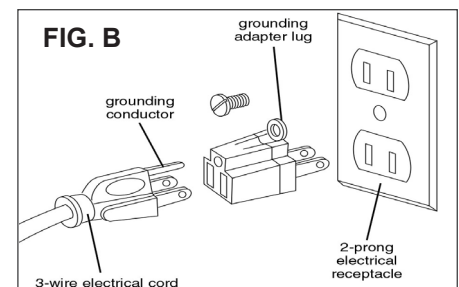

SAFETY INSTRUCTIONS

SPECIFIC SAFETY INSTRUCTIONS FOR WOOD LATHES

This machine is intended for the shaping, smoothing and finishing of solid woods and composite materials made specifically for lathe work. The permissible work piece dimensions must be observed (see Technical Specification). Any other use not as specified, including modification of the machine or use of parts not tested and approved by the equipment manufacturer, can cause unforeseen damage and invalidate the warranty.

ATTENTION: Use of this lathe still presents risks that cannot be eliminated by the manufacturer. Therefore, the user must be aware that wood working machines are dangerous if not used with care and all safety precautions are adhered to.

1. Do not operate this machine until you have read all of the following instructions.
2. Do not attempt to operate this machine until it is completely assembled.
3. Do not turn ON this machine if any pieces are damaged or missing.
4. This machine must be properly grounded.
5. If you are not familiar with the operation of the machine, obtain assistance from a qualified person.
6. Always wear approved, safety protective eye wear and hearing protection when operating this machine.
7. Always wear a dust mask and use adequate dust collection and proper ventilation.
8. Do not wear loose clothing or jewelry when operating this machine. Keep long hair tied back.
9. Always make sure the power switch is in the OFF position prior to plugging in the machine.
10. Always make sure the power switch is in the OFF position and the machine is unplugged when doing any cleaning, assembly, setup operation, or when not in use.
11. Use only sharp lathe tools. Dull tools can damage your work and are unsafe to use.
12. When turning between centers, make sure the headstock and tailstock are snug against the work piece.
13. When face plate turning, rough-cut the work close to the finished shape before screwing it to the face plate.
14. Never jam tools into the work piece or take too big of a cut.
15. Make sure there are no loose knots, nails, staples, dirt or foreign objects in the work piece to be turned.
16. Wood should not be warped, cracked or have improperly made or cured glue joints.
17. Test spin the work piece to ensure that it does not hit the lathe bed or tool rest before turning on the lathe.
18. Start the lathe at slow speeds to check the settings, then increase the speed to your desired level for working.
19. Low speeds are best for roughing stock, and for long or large diameter work pieces.
20. If excessive vibration occurs, stop the lathe to check the work piece settings between centers or on face plates.
21. For sanding or applying finishes, remove the tool rest from the machine. Use low speeds to avoid heat build-up.
22. Never stop the machine by grabbing the work piece, faceplate or hand wheel. Let the machine stop on its own.
23. The use of any accessories or attachments not recommended may cause injury to you and damage your machine.
24. Remove material or debris from the work area. Keep the floor and work area neat and clean.
25. Keep these instructions for future reference.

This owner's manual is not a teaching aid and is intended to show assembly, adjustments, and general use.

CALIFORNIA PROPOSITION 65 WARNING: Some dust created by power sanding, sawing, grinding, drilling, and other construction activities contains chemicals known to the State of California to cause cancer and birth defects or other reproductive harm. Your risk from exposure to these chemicals varies, depending on how often you do this type of work. To reduce your exposure, work in a well-ventilated area and with approved safety equipment, such as dust masks that are specially designed to filter out microscopic particles.

For more detailed information about California Proposition 65 log onto rikontools.com.

GETTING TO KNOW YOUR MACHINE

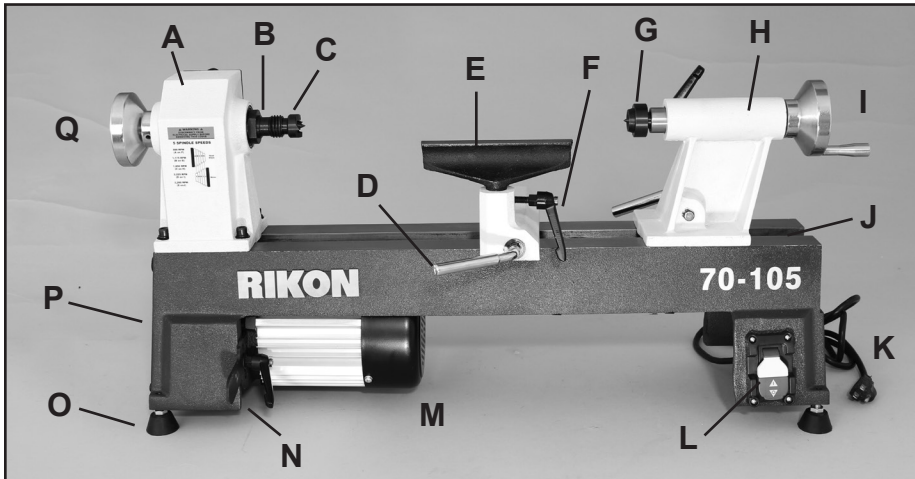

- A Headstock
- B Spindle
- C Spur center
- D Tool rest base locking lever
- E Tool rest
- F Tool rest locking lever
- G Live center
- H Tailstock
- I Tailstock hand wheel
- J Lathe bed
- K Electric cord & plug
- L On / Off switch

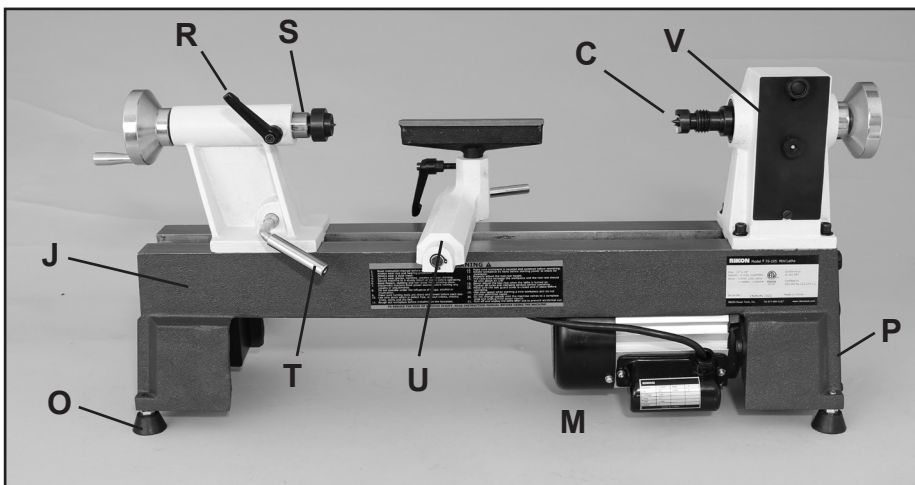

- M Motor
- N Motor mount & pivot lever
- O Rubber feet
- P Motor pulley & cover
- Q Spindle hand wheel
- R Tailstock spindle lock
- S Tailstock spindle (RAM)
- T Tailstock locking lever
- U Tool rest base
- V Spindle pulley & cover

CONTENTS OF PACKAGE

Model #70-105 Mini Lathe is shipped complete in one box.

Unpacking and Clean-up

1. Carefully remove all contents from the shipping carton. Compare the contents with the list of contents to make sure that all of the items are accounted for, before discarding any packing material. Place parts on a protected surface for easy identification and assembly. If any parts are missing or broken, please call RIKON Customer Service (877-884-5167) as soon as possible for replacements. DO NOT turn your machine ON if any of these items are missing. You may cause injury to yourself or damage to the machine.
2. Report any shipping damage to your local distributor.
3. Clean all rust protected surfaces with ordinary house hold type grease or spot remover. Do not use; gasoline, paint thinner, mineral spirits, etc. These may damage painted surfaces.
4. Apply a coat of paste wax to the lathe bed to prevent rust. Wipe all parts thoroughly with a clean dry cloth.
5. Set packing material and shipping carton aside. Do not discard until the machine has been set up and is running properly.

CONTENTS OF PACKAGE

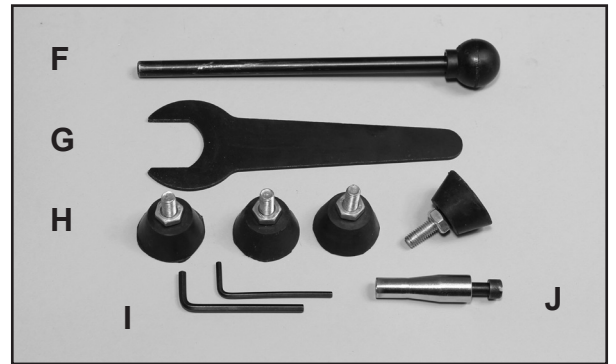
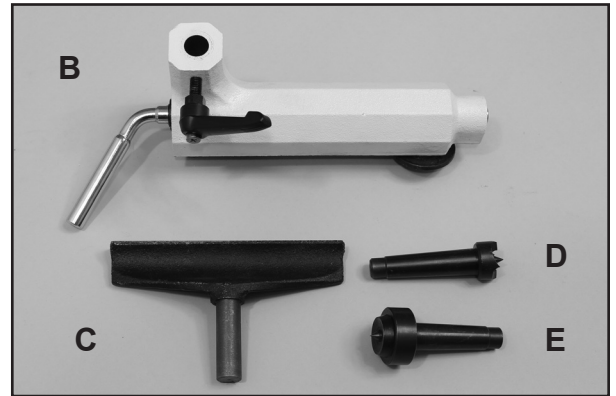
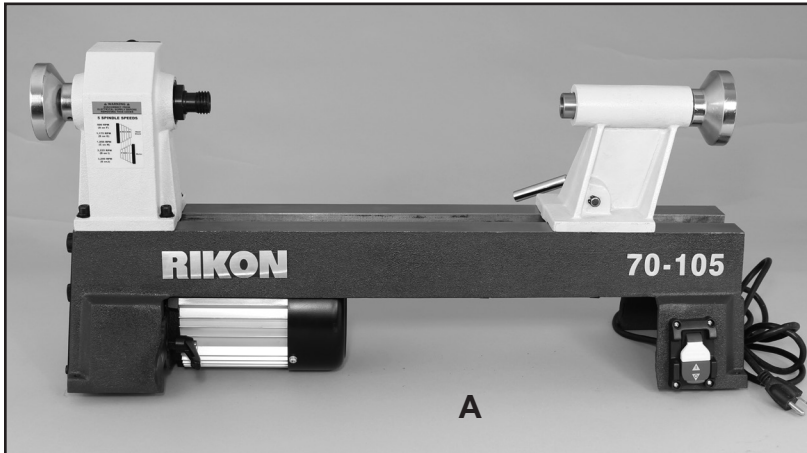

LIST OF LOOSE PARTS

- A Lathe Bed with Headstock, Tailstock and Motor Assemblies
- B Tool Rest Base Assembly
- C 6" Tool Rest
- D Spur Center
- E Live Center
- F Knockout Bar
- G 32mm Wrench
- H Rubber Feet with mounting screw (4)
- I 3mm & 4mm Hex Wrenches
- J Tailstock Hand Wheel & Screw
- K Manual & Warranty Card (not shown)

TOOLS NEEDED FOR ASSEMBLY

- Slotted Screwdriver
- 13mm & 17mm or Adjustable Wrenches

INSTALLATION

MOVING & INSTALLING THE LATHE

1. When moving the lathe, **DO NOT** use the headstock assembly, motor, tool rest or tailstock assembly as this may damage the machine. Hold under the lathe's bed to lift and move the machine.
2. The lathe is supplied with rubber feet for use on a bench. To permanently mount the machine on a bench, use the four mounting holes in lathe's base. Remove the rubber feet and insert 1" to 1-1/4" thick spacers (washers, bushings, wood strips) under the lathe when screwing or bolting the machine down (mounting hardware is not provided). **NOTE:** The TEFC motor requires 1" extra space below the bed to allow airflow and room to pivot the motor down for belt changes. For mounting on a stand, the spacers may not

be needed if the motor can swing free below the bed casting when mounted on the stand plate.

3. For best power and safety, the lathe should be plugged directly into a dedicated grounded electrical outlet that is within the supplied cord length of the machine. The use of an extension cord is not recommended.
4. Align the machine so there is ample space in front and in back for working and moving around it. Locate it so any turning debris or kickback will not face aisles, doorways, or other work areas that bystanders may be in. Do not locate or use the machine in damp or wet conditions.
5. Make sure that the machine is level. If possible, secure it to a bench or its stand to the floor with lag screws (not supplied). This will reduce any possible vibration during use.

ASSEMBLY

NOTE: Pending packaging changes at the factory, some lathe parts may already be pre-assembled on the machine. The assembly steps listed should none-the-less be reviewed for information on the lathe parts and their adjustments.



WARNING

THE MACHINE MUST NOT BE PLUGGED IN AND THE POWER SWITCH MUST BE IN THE OFF POSITION UNTIL ALL ADJUSTMENTS ARE COMPLETE.

INSTALL THE RUBBER FEET

1. Screw the rubber feet onto the four corners of lathe bed casting. The threaded post's upper hex nut will secure and adjust the feet height, if necessary, if the bench is not level. FIG. 1.

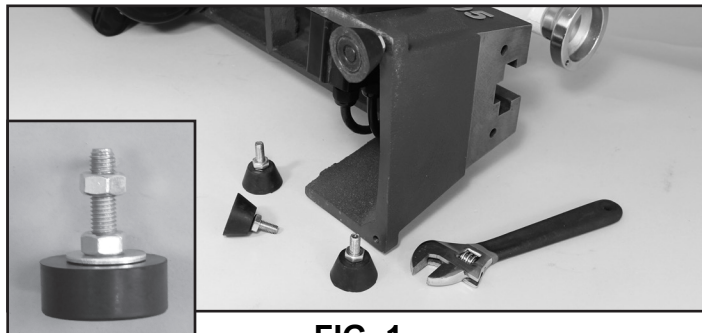

FIG. 1

INSTALL THE TOOL REST BASE

1. Remove the tailstock assembly from the lathe bed. Release the locking lever handle (A) at the rear of the tailstock, and slide the tailstock assembly off of the end of the lathe bed. FIG. 2

2. Slide the tool rest base onto the lathe bed.

NOTE: To adjust the clamping action of the tool rest base, or tailstock, adjust the locking nut (B) - turn it clockwise to tighten, and counterclockwise to loosen. This nut adjustment can be done when the tool rest base or tailstock are on, or off of the lathe bed. The locking lever must be loose when the nut is adjusted. Then, with the tool rest base or tailstock installed on the bed, test the clamping action after nut adjustments are made.

3. Re-install the tailstock onto the lathe bed.

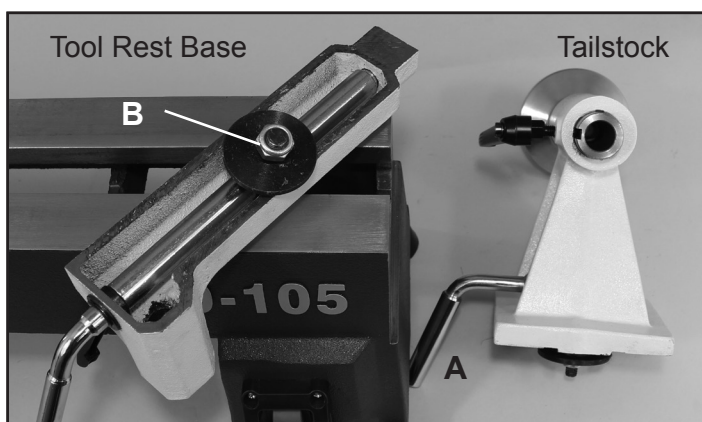

FIG. 2

INSTALL THE TAILSTOCK HANDLE

1. With a slotted screwdriver (not supplied) attach the tailstock handle (C) to the hand wheel with the screw provided. FIG. 3.

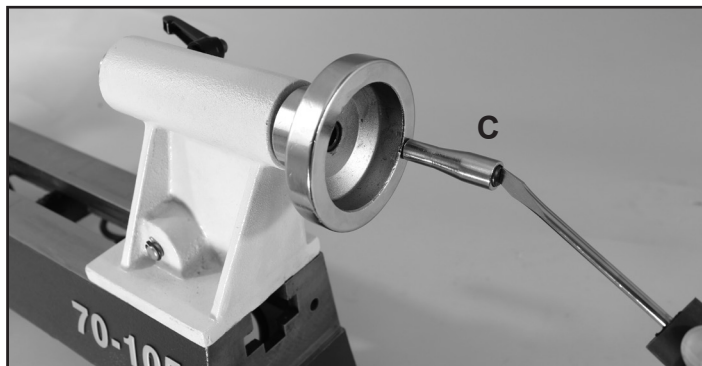

FIG. 3

INSTALL THE TOOL REST

1. Loosen the locking lever on the side of the tool rest base, and insert tool rest post into the base.

2. Adjust the tool rest's height up or down to your desired position, and then secure The tool rest base in place with is locking lever. FIG. 4.

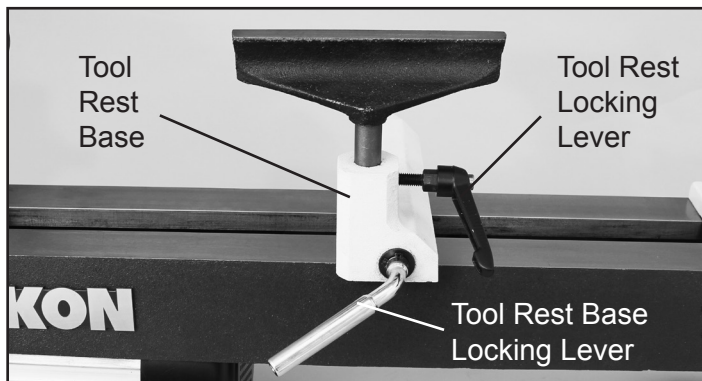

FIG. 4

ASSEMBLY



WARNING

THE MACHINE MUST NOT BE PLUGGED IN AND THE POWER SWITCH MUST BE IN THE 'OFF' POSITION UNTIL ASSEMBLY IS COMPLETE.

INSTALL THE SPUR CENTER

Insert the spur center into the headstock spindle. The spur center (A) has a No. 2 Morse Taper shank, that matches the taper on the inside of the headstock spindle for a secure, friction fit. FIG. 5.

NOTE: If replacing the spur center, or purchasing new centers, make sure that the item is machined with a No. 2 Morse Taper shank.

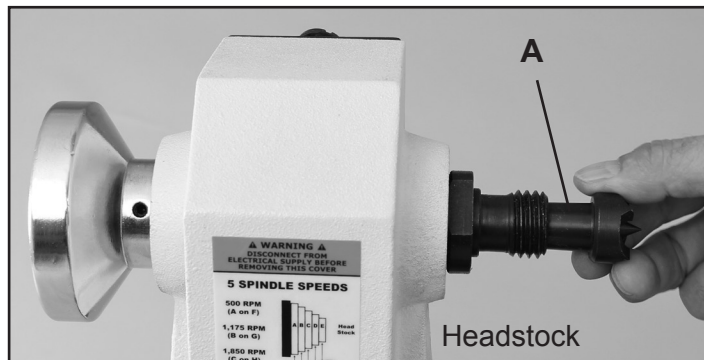

FIG. 5

THE KNOCKOUT BAR

The knockout bar (B) is used to remove the spur center from the headstock spindle.

Insert the knockout bar into the spindle hole at opposite side from spur center. The knockout bar is then used to hit the back end of the spur center to release it from the spindle. Carefully hold the spur center as it is knocked out of the spindle, so that it does not fly out and get damaged, or injure your hand. FIG. 6.



FIG. 6

INSTALL THE LIVE CENTER

Insert the live center (C) into the tailstock spindle. This center also has a No. 2 Morse Taper shank. FIG. 7.

To remove live center from the tailstock spindle, loosen the tailstock's spindle locking lever and rotate the hand wheel counterclockwise to retract spindle into the body of the tailstock. The live center will automatically be pushed out of the spindle. Carefully hold the live center as it is pushed out of the spindle, so that it does not fall out and get damaged, or injure your hand. The knockout bar (B) can also be used to release the live center from the tailstock. FIG. 8.

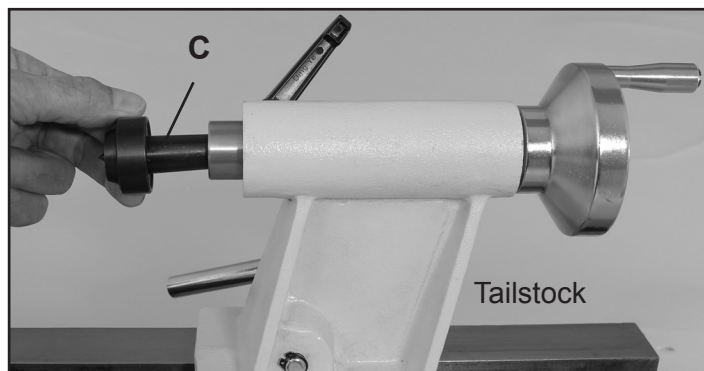

FIG. 7

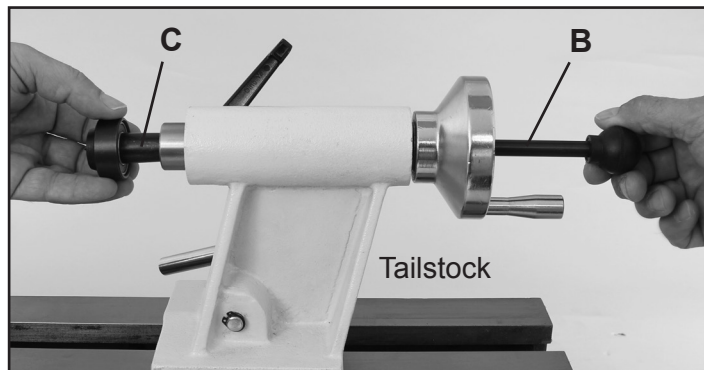

FIG. 8

ASSEMBLY

INSTALLING A FACEPLATE

The 70-105 lathe is designed with pen turning in mind, and DOES NOT include a faceplate which is used for mounting wood for the making of plates, dishes, small trays and bowls up to 10" diameter. Faceplates with 1"x8 TPI threading are available separately. To mount on your lathe:

1. Securely mount your wood onto the faceplate with wood screws. The work piece should be "rough cut" as close as possible to the finished round shape before mounting.

2. Thread the faceplate clockwise onto the headstock spindle. FIG. 9.

3. Secure the faceplate in place onto the spindle with a hex wrench, and/or an open end wrench, pending the fastening design of faceplate used.

4. Set the tool rest to the proper position and height for turning the wood. See page 14 for recommended RPM speeds for working different diameters. Set the lathe speeds accordingly - see page 12 for instructions on the process.

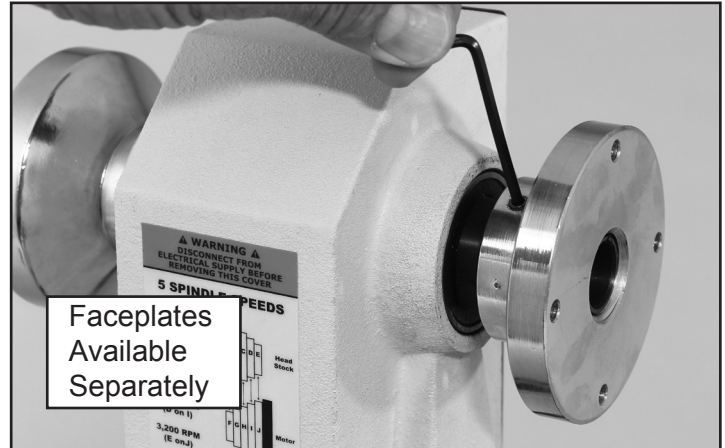

FIG. 9

5. After completing your turning, remove the faceplate from the headstock spindle by reversing steps 2-3.

6. Once the faceplate has been removed from the lathe, the finished turned work can be removed from the faceplate by removing the fastening screws. The holes in the rear of your work can be filled or plugged for best appearance.

Visit RIKON's website at www.rikontools.com for a list of accessories for use with wood lathes.

ADJUSTMENTS

ADJUSTING THE TOOL REST

The tool rest base can be easily moved along the lathe bed to position it along the length of your work piece, and also adjusted in or out to set the tool rest close to the work for turning. Loosen the tool rest base locking lever counterclockwise, slide tool rest base to a new position, and then re-tighten the base's locking lever, clockwise.

To adjust the height of the tool rest, loosen the tool rest locking lever, raise or lower tool rest, then re-tighten the rest's locking lever. FIG. 10.

Note: Position the tool rest as close to the work piece as possible. It should be 1/8" above the center line of the work piece.

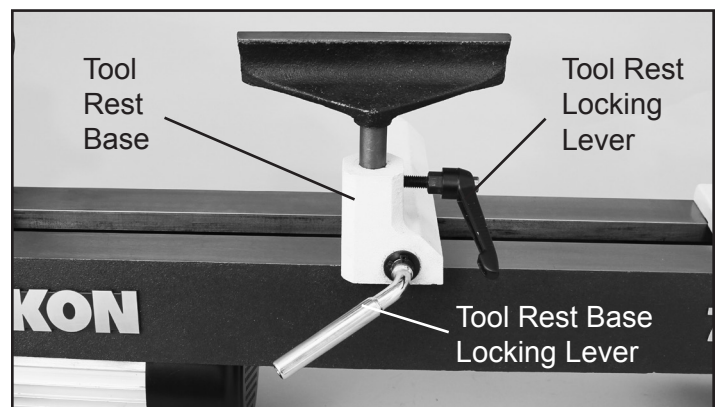

FIG. 10

NOTE: To adjust the clamping action of the tool rest base, or the tailstock, adjust the locking nut - turn it clockwise to tighten, and counterclockwise to loosen. See FIG. 2 and instructions on page 9.

ADJUSTMENTS

ADJUSTING THE TAILSTOCK

Loosen the locking lever (A) to move the tailstock along the lathe bed to the desired position for holding your work piece. Then tighten the locking lever to secure the tailstock on the bed. FIG. 11.

To adjust the clamping action of the tailstock on the bed, adjust the lower locking nut. See the instructions listed on page 9, FIG. 2.

To adjust the tailstock spindle in or out to hold or release your work piece, loosen the locking lever (B) and turn the hand wheel (C). The tailstock spindle (ram) (D) will travel from 0" to 1-3/4". When the tailstock spindle holding the live center (E) is in a desired position, tighten the locking lever (A). FIG. 11.

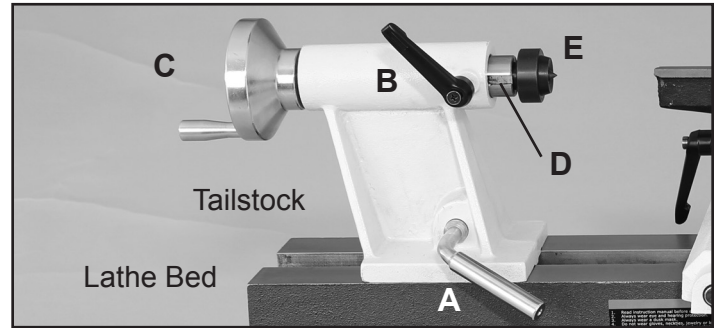
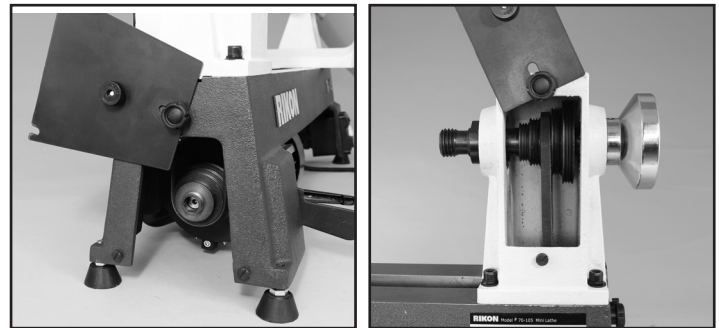

FIG. 11



Motor Pulley

FIG. 12

Spindle Pulley

⚠ WARNING THE MACHINE MUST NOT BE PLUGGED IN AND THE POWER SWITCH MUST BE IN THE OFF POSITION UNTIL ALL ADJUSTMENTS ARE COMPLETE.

CHANGING SPINDLE SPEEDS

The lathe features five step motor and spindle pulleys to provide different spindle speeds. Open the two access covers to change spindle speeds. FIG. 12.

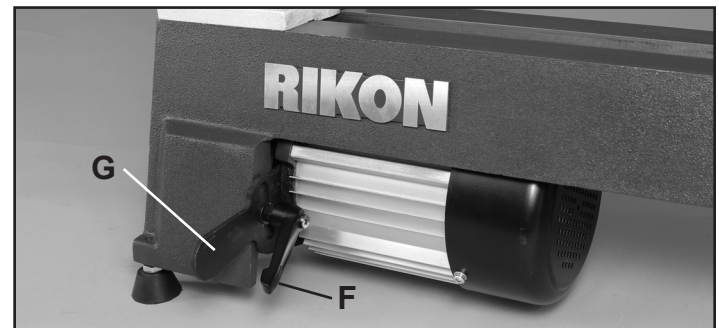
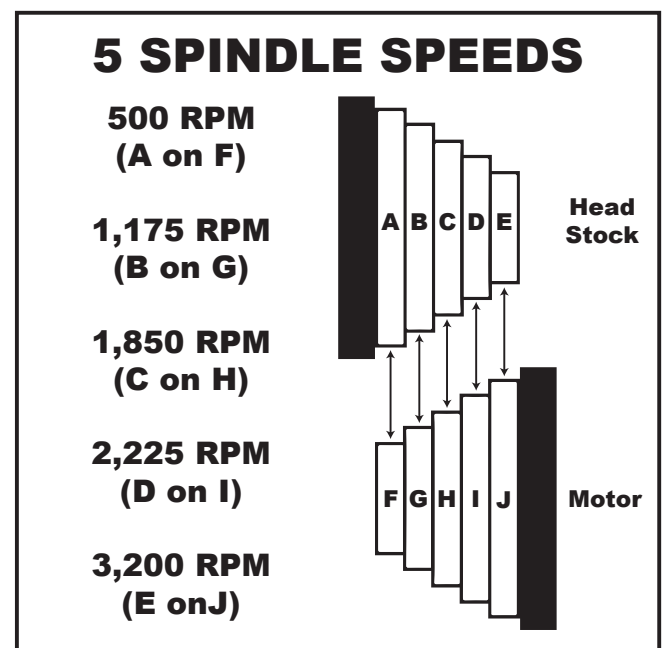

FIG. 13

1. With the access covers open, loosen the locking lever handle (F) that secures the motor in place, and raise the motor mounting plate lever (G) to release the belt tension on the motor and spindle pulleys.
2. Check the speed and belt position chart to determine the spindle speed required for your turning. Then move the drive belt to the desired pulley combination.
3. With the locking lever handle and motor being loose, the motor's weight will provide the proper tension on the drive belt. Re-tighten the locking lever and close access covers. **NOTE:** Do not put excess tension on the drive belt or excess wear or damage to the bearing or motor may result.



ADJUSTMENTS

CHANGING THE DRIVE BELT

To change the belt, the whole spindle shaft needs to be shifted right, out of the headstock, towards the tailstock. This will allow the new belt to be slipped over the spindle and onto the spindle pulley. Then the whole spindle shaft assembly can be re-installed so turning can be resumed.

1. Unplug the lathe from the power source.
2. Remove any accessories from the spindle - spur center, pen mandrel, chuck, faceplate, etc..
3. Open the rear spindle pulley cover (FIG. 14, A) and the lower, side motor pulley cover (B) to gain access to the drive belt and pulleys that are inside of the headstock and bed casting.
4. Loosen the motor mount locking lever handle (FIG. 13, F) and lift the motor mounting plate lever (G) to loosen the tension on the belt. The belt can now be removed from the lower motor pulley (FIG. 14, B).

5. Loosen the set screws that attaches the hand wheel (C) to the spindle, and remove the hand wheel. FIG. 15.

6. Remove the set screw(s) that attaches the spindle pulley to the spindle. The pulley should now be loose on the spindle. FIG. 14, A.
NOTE: There may be two (2) set screws in the threaded hole, one on top of the other. If assembled in this manner, this stacking prevents the set screws from loosening during use.

7. Carefully knock the spindle, towards the tailstock. Use a block of wood against the spindle end to prevent any damage when it is hit with a mallet/hammer. The spindle pulley, now loose, will slide along the spindle.

8. Remove the old belt, if present, and install the new belt over the spindle pulley. Return the pulley back onto the spindle, and re-install the spindle back into the headstock casting. As in step 7, carefully knock the spindle and bearings back into place with a block of wood and mallet.

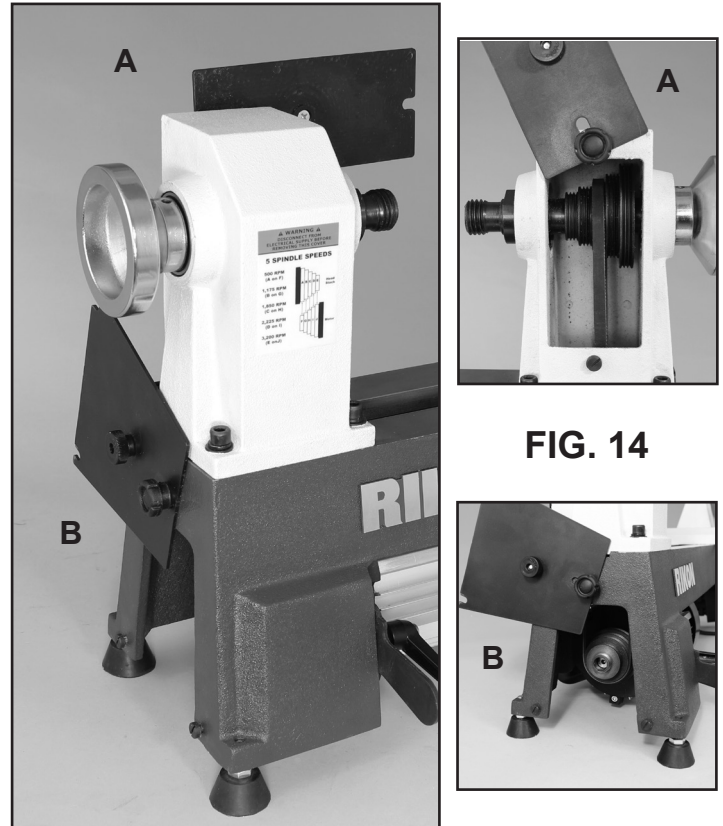

FIG. 14

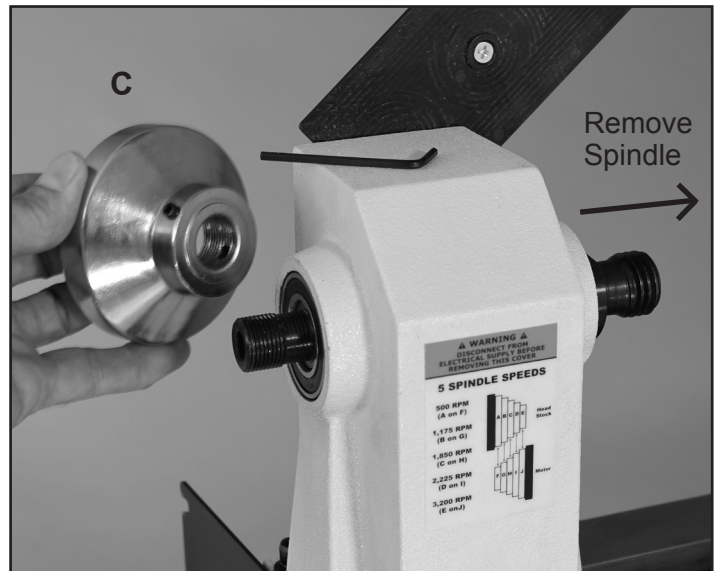

FIG. 15

9. Secure the spindle pulley in place on the spindle with the set screw(s). Make sure that the set screws engage back onto the flat section on the spindle to eliminate slippage.
10. Re-assemble the remaining headstock parts by reversing the procedure previously described.

ADJUSTMENTS

Changing the Bearings

If the bearings ever need to be changed, the whole spindle shaft needs to be shifted right, out of the headstock, towards the tailstock. Then the bearings can be removed from the headstock casting. With the new bearings in place, the spindle shaft assembly can be re-installed, so turning can be resumed.

1. Unplug the lathe from the power source.
2. Remove any accessories from the spindle - spur center, pen mandrel, chuck, faceplate, etc..
3. Follow the steps 2-7 described in CHANGING THE DRIVE BELT on page 13, to remove the hand wheel and loosen the spindle pulley from the spindle. The drive belt will be loose on the spindle.

4. Carefully knock out the spindle towards the tailstock. Use a block of wood or big dowel against the spindle end to prevent any damage when it is hit with a mallet/hammer. The spindle pulley, now loose, will slide along the spindle.

5. Carefully pull out, or knock out the old bearings. Use a mallet/hammer with a block of wood against the bearings to prevent any damage to the machine. Do not remove the large retaining C-Clips from the inside of the castings. These clips properly position the bearings when in place.

6. Install the two new Bearings in the front and in the rear holes of the headstock.

7. Re-assemble the lathe parts by reversing the procedure previously described.

OPERATION

⚠ WARNING

It is strongly recommended that you read books, trade magazines, or get formal training to maximize the potential of using your lathe, while also minimizing the risks. Before turning on the machine, review the safety precautions on pages 3 to 6. Make sure that you fully understand the features, adjustments and capabilities of the machine that are outlined throughout this manual.

Typical Lathe Turning Operations

FIG. 16 shows the lathe set up for a typical spindle turning operation. **Note:** Position the tool rest as close to the work piece as possible. It should be 1/8" above the center line of the work piece.

For turning plates, bowls and small turnings, a chuck or faceplates can be used (available separately). The work piece should be "rough cut" as close as possible to the finished round shape before mounting. FIG. 17.

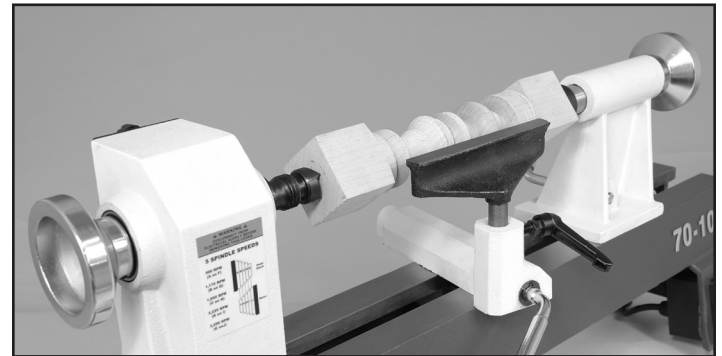

FIG. 16

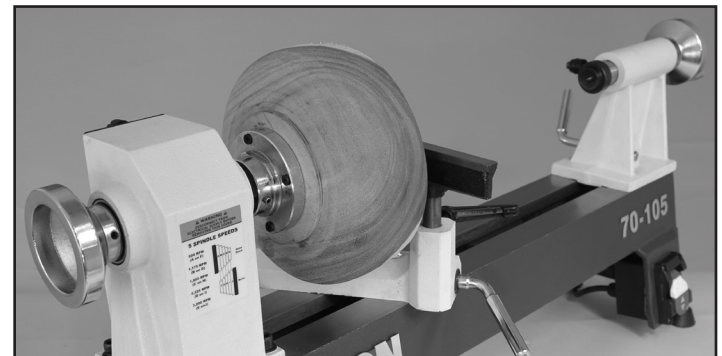

FIG. 17

DIAMETER OF WORK	ROUGHING RPM	GENERAL CUTTING RPM	FINISHING RPM
Under 2"	1520	3200	3200
2 to 4"	750	1600	2480
4 to 6"	510	1080	1650
6 to 8"	380	810	1240
8 to 10"	300	650	1000
10 to 12"	255	540	830

MAINTENANCE

⚠ WARNING: Turn the power switch “OFF” and disconnect the plug from the outlet prior to adjusting or maintaining the machine. DO NOT attempt to repair or maintain the electrical components of the motor. Contact a qualified service technician for this type of maintenance.

1. Before each use:

- Check the power cord and plug for any wear or damage.
- Check for any loose screws, hardware, locking handles, jigs or various lathe accessories.
- Check the area to make sure it is clear of any misplaced tools, lumber, cleaning supplies, etc. that could hamper the safe operation of the machine.

2. Avoid a build-up of wood shavings and dust. Regularly clean all parts of the machine using a soft cloth, brush or compressed air. A general cleaning should be done after every use to avoid future problems and ensure that the machine is in ready condition for its next use.

WARNING: If blowing sawdust, wear a proper dust mask and eye protection to prevent debris from being inhaled and blowing into your eyes.

3. Keep the lathe bed free of resin and rust. Clean it regularly with a non-flammable solvent, then coat with a light film of dry lubricant spray, or wax, to enhance passage of the tool rest and tailstock on/over the bed.

4. Keep the lathe tools sharp, and make sure the steel is not loose in the handles so that no accidents might occur. Making sure that tools are in proper operating condition will ensure that the quality of your turning will be the best possible.

5. Check all lathe accessories (spur centers, live centers, chucks, tool rests, etc.) to ensure that they are in perfect working condition.

6. The lathe’s ball bearings are lifetime lubricated, sealed, and do not need any further care. Keep the drive belt free of oil and grease to prevent slipping on the pulleys.

WIRING DIAGRAM

⚠ WARNING: This machine must be grounded. Replacement of the power supply cable should only be done by a qualified electrician. See page 5 for additional electrical information.

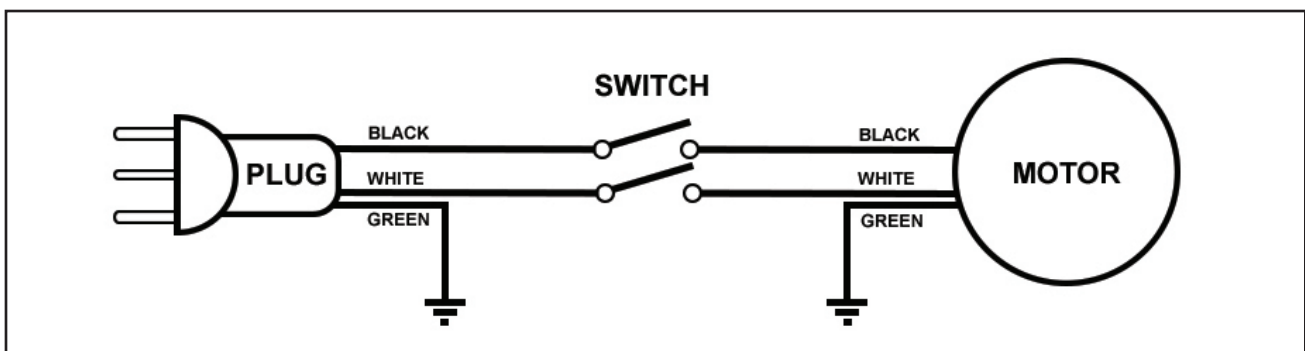

This tool is intended for use on a circuit that has a 120 volt electrical receptacle. The illustration on page 5 shows the type of the 120v, 3-wire electrical plug and electrical receptacle that has a grounding conductor that is required.

TROUBLESHOOTING

PROBLEM	PROBABLE CAUSE	REMEDY
Motor will not start	<ol style="list-style-type: none"> 1. Machine is not plugged in 2. Low voltage 3. Loose connection 	<ol style="list-style-type: none"> 1. Plug in machine 2. Check fuses 3. Check plug and all connections
Motor fails to develop full power.	<ol style="list-style-type: none"> 1. Power line is overloaded 2. Undersize wires in supply system 3. Drive belt tension is too high 4. Low voltage 5. Worn motor 	<ol style="list-style-type: none"> 1. Correct the overload condition 2. Increase supply wire size or eliminate extension cord if one is used 3. Adjust belt tension 4. Have voltage checked by an electrician and corrected, if necessary 5. Replace the motor
Motor or Spindle Stalls or will not start	<ol style="list-style-type: none"> 1. Excessive depth of cut 2. Loose or broken belt 3. Worn spindle bearings 4. Improper cooling of motor 5. Worn motor 	<ol style="list-style-type: none"> 1. Reduce cutting depth 2. Check tension or replace drive belt 3. Replace bearings 4. Clean motor to increase air flow, or reduce motor running time 5. Replace Motor
Motor overheats	<ol style="list-style-type: none"> 1. Motor is overloaded 2. Air flow restricted on the motor 	<ol style="list-style-type: none"> 1. Reduce load on the motor 2. Clean motor to increase air flow
Excessive Vibration.	<ol style="list-style-type: none"> 1. Work piece is warped, out of round, has major flaw, or was improperly prepared or centered for turning 2. Worn spindle bearings 3. Worn belt 4. Motor mount bolt or handles are loose 5. Lathe is on an uneven surface 	<ol style="list-style-type: none"> 1. Correct problem by planing, band sawing, or discard the work piece 2. Replace the bearings 3. Replace the belt 4. Tighten all bolts or handles 5. Shim the lathe stand, or adjust the feet on the stand for stability
Tailstock Moves when applying pressure	<ol style="list-style-type: none"> 1. Excessive pressure being applied by the tailstock onto the work piece 2. Tailstock is not secured in place 3. Lathe bed and tailstock mating surfaces are greasy or oily. 	<ol style="list-style-type: none"> 1. Apply only sufficient force with the tailstock to hold the work piece securely between centers. 2. Tighten tailstock locking lever 3. Remove tailstock and clean bed surfaces with a cleaner degreaser
Tailstock or Tool Rest Base do not lock in place	<ol style="list-style-type: none"> 1. Incorrect adjustment on locking lever mechanism 	<ol style="list-style-type: none"> 1. Adjust the nut under the clamping plate to increase (or decrease) the clamping pressure of the lock levers
Machine bogs down during cutting	<ol style="list-style-type: none"> 1. Excessive depth of cut is taken 2. Turning tools are dull 	<ol style="list-style-type: none"> 1. Decrease the depth of cut 2. Sharpen the turning tools
Tools tend to grab or dig in.	<ol style="list-style-type: none"> 1. Dull turning tools 2. Tool rest is set too low 3. Tool rest is set too far from the work piece 4. Improper turning tool is being used 	<ol style="list-style-type: none"> 1. Sharpen the tools 2. Reposition the tool rest height 3. Set the tool rest closer to the work piece 4. Use the correct tool for operation

For parts or technical questions contact: techsupport@rikontools.com or 877-884-5167.

ACCESSORIES

70-906 21" LATHE BED EXTENSION

Made of heavy cast iron, it bolts to the right end of the 70-105 Mini Lathe to extend the lathe's working spindle length capacity to 39". Includes adjustable rubber feet to match lathe height.



70-920 LATHE STAND

Universal, all-steel Stand adjusts from 23-1/4" to 37-1/4" long, and 24-1/2" to 34-1/2" working height.



ADDITIONAL LATHE ACCESSORIES

For additional lathe accessories or replacement parts, contact your local RIKON distributor, or visit the RIKON website at www.rikontools.com.

Tool rests, Face Plates, Drive Centers, Spur & Live Centers, Drill Chuck & Arbor, Drive Belts, etc.

70-913 LATHE STAND EXTENSION

Universal, all-steel Stand Extension bolts onto the 70-910 and 70-920 stands to support lathes with Bed Extensions. The stand extension adjusts from 18-3/4" to 32-1/4" long, and 24-1/2" to 34-1/2" working height.



WARRANTY

RIKON

POWER TOOLS

5-Year Limited Warranty

RIKON Power Tools Inc. ("Seller") warrants to only the original retail consumer/purchaser of our products that each product be free from defects in materials and workmanship for a period of five (5) years from the date the product was purchased at retail. This warranty may not be transferred.

This warranty does not apply to defects due directly or indirectly to misuse, abuse, negligence, accidents, repairs, alterations, lack of maintenance or normal wear and tear. Under no circumstances will Seller be liable for incidental or consequential damages resulting from defective products. All other warranties, expressed or implied, whether of merchantability, fitness for purpose, or otherwise are expressly disclaimed by Seller. This warranty does not cover products used for commercial, industrial or educational purposes.

This limited warranty does not apply to accessory items such as blades, drill bits, sanding discs, grinding wheels, belts, ball bearings and other related items.

Seller shall in no event be liable for death, injuries to persons or property, or for incidental, contingent, special, or consequential damages arising from the use of our products.

To take advantage of this warranty, proof of purchase documentation must be provided which has the date of purchase and an explanation of the complaint.

The Seller reserves the right to effect at any time, without prior notice, those alterations to parts, fittings, and accessory equipment which they may deem necessary for any reason whatsoever.

To take advantage of this warranty, please fill out the enclosed warranty card and send it to:
RIKON Warranty, 16 Progress Rd., Billerica, MA 01821

The card must be entirely completed in order for it to be valid. If you have any questions please contact us at 877-884-5167 or warranty@rikontools.com.

PARTS DIAGRAM

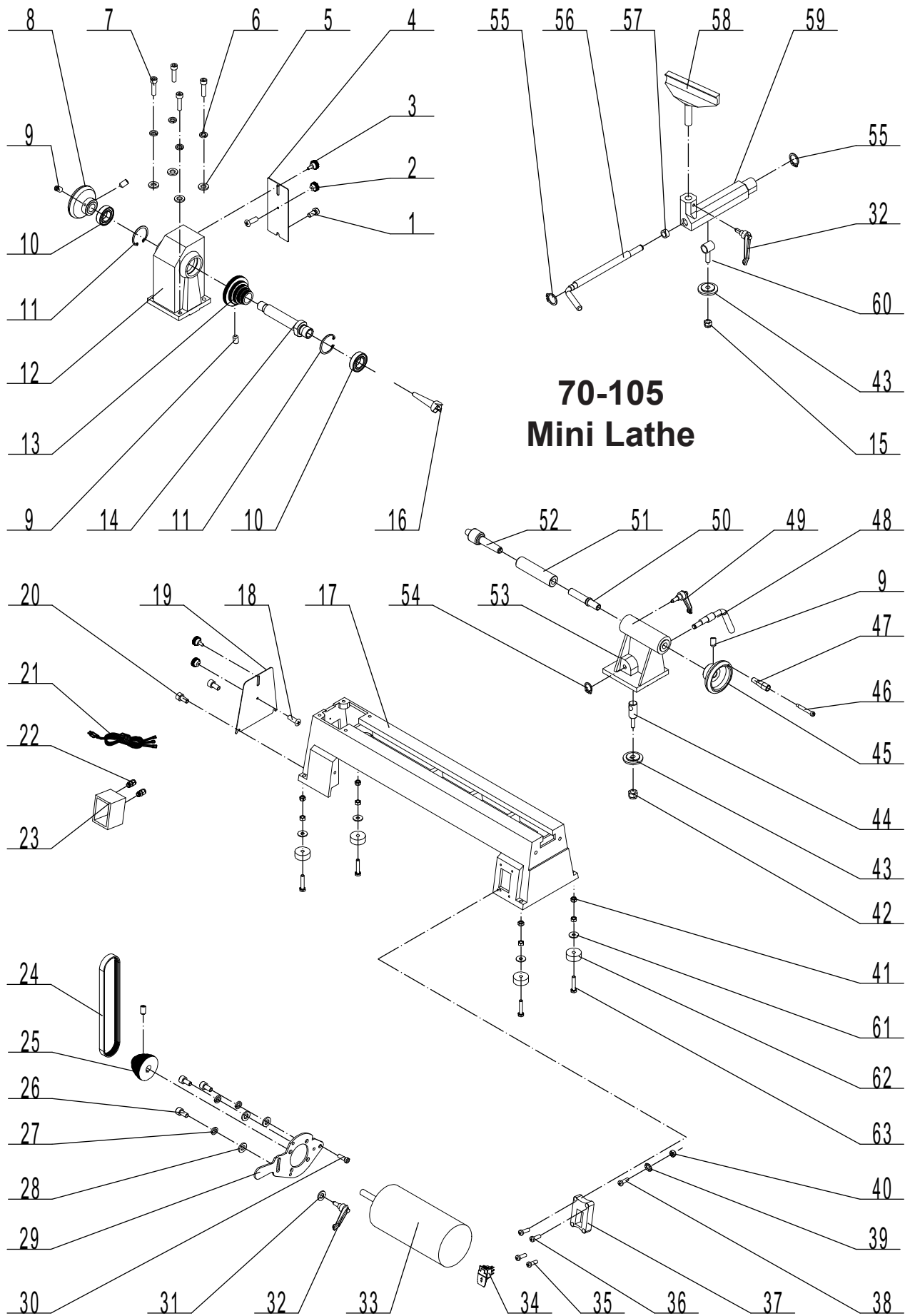

**70-105
Mini Lathe**

PARTS LIST

70-105 10" x 18" Mini Lathe

KEY NO.	DESCRIPTION	QTY	PART NO.	KEY NO.	DESCRIPTION	QTY	PART NO.
1	Screw M5X10	1	P70-105-1	33	Motor	1	P70-105-33
2	Stationary Knob	2	P70-105-2	34	Switch	1	P70-105-34
3	Moving Knob	2	P70-105-3	35	Screw M4X30	2	P70-105-35
4	Back Lid	1	P70-105-4	36	Screw M4X25	2	P70-105-36
5	Washer 6	4	P70-105-5	37	Plate	1	P70-105-37
6	Spring Washer 6	4	P70-105-6	38	Screw M5X25	1	P70-105-38
7	Hex Socket Head Screw M6X25	4	P70-105-7	39	Washer 5	1	P70-105-39
8	Balance Wheel	1	P70-105-8	40	Nut 5	1	P70-105-40
9	Hex Socket Set Screw M6X10	5	P70-105-9	41A	Nut 8	8	P70-105-41A
10	Ball Bearing 6005-2RS	2	P70-105-10	42	Hex Nut 8	1	P70-105-42
11	Retaining Ring 47	2	P70-105-11	43	Lock Plate	2	P70-105-43
12	Headstock	1	P70-105-12	44	Threaded Shaft	1	P70-105-44
13	Drive Pulley	1	P70-105-13	45	Hand Wheel	1	P70-105-45
14	Headstock Spindle	1	P70-105-14	46	Screw M6X50	1	P70-105-46
15	Hex Nut 10	1	P70-105-15	47	Rotation Handle	1	P70-105-47
16	Headstock Spur Center	1	P70-105-16	48	Locking Lever	1	P70-105-48
17	Bed	1	P70-105-17	49	Locking Handle	1	P70-105-49
18	Screw M5X10	2	P70-105-18	50	Tailstock Quill	1	P70-105-50
19	Side Plate	1	P70-105-19	51	Tailstock Locking Shaft	1	P70-105-51
20	Screw M5X10	2	P70-105-20	52	Live Center	1	P70-105-52
21	Power Cord	1	P70-105-21	53	Tailstock	1	P70-105-53
22	Cord Strain Relief M14	2	P70-105-22	54	Retaining Ring 10	1	P70-105-54
23	Electric Box	1	P70-105-23	55	Retaining Ring 12	2	P70-105-55
24	Drive Belt 630mm	1	P70-105-24	56	Locking Lever	1	P70-105-56
25	Motor Pulley	1	P70-105-25	57	Locking Sleeve	1	P70-105-57
26	Hex Socket Head Screw M6X16	3	P70-105-26	58	Tool Rest	1	P70-105-58
27	Spring Washer 6	3	P70-105-27	59	Tool Rest Base	1	P70-105-59
28	Washer 6	3	P70-105-28	60	Threaded Shaft & Sleeve	1	P70-105-60
29	Motor Plate	1	P70-105-29	61	Big Washer 8	4	P70-105-61
30	Screw M8X12	1	P70-105-30	62	Rubber Foot	4	P70-105-62
31	Big Washer 8	1	P70-105-31	63	Hex Bolt M8x40	4	P70-105-63
32	Locking Handle	2	P70-105-32				

NOTE: Please reference the Manufacturer's Part Number when calling for Replacement Parts.
For Parts under Warranty, the Serial Number of your machine is required.



**For more information:
16 Progress Road
Billerica, MA 01821**

**877-884-5167 / 978-528-5380
techsupport@rikontools.com**