

COSCO®

SIMPLE

SMART

FUN

www.coscokids.com

COSCO®

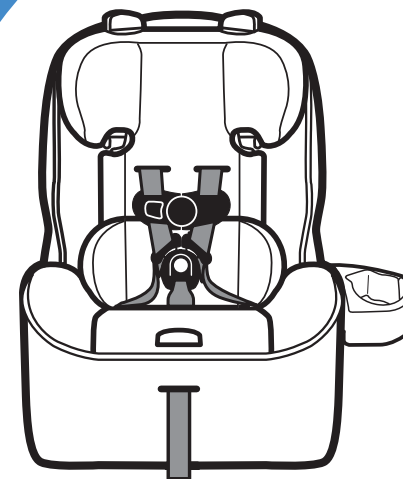

4358-7844
9.9.19



EASY ELITE

3-IN-1 CAR SEAT

KEEP INSTRUCTIONS FOR FUTURE USE.
Read all instructions before using this car seat.

WARNING ⚠ Failure to follow the warnings on the labels and in the instruction manual can result in serious injury or death to your child.

Overview

Welcome to the Cosco family and thank you for choosing this car seat, also known as a child restraint!

To help you get started using your child's new car seat, here are the 4 main tasks you'll need to complete:

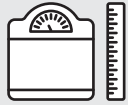

Measure Your Child



Adjust Car Seat to Fit Your Child



Install Car Seat into Your Vehicle



Snugly Secure Your Child in Car Seat

Your child's safety is worth the time it will take for you to read and follow these instructions.

Ready? Let's go!

Pages 1-3 will introduce you to the parts of the car seat.

Page 77 has our contact information. If at any point you would like assistance, please feel free to reach out to us.

Quick Navigation

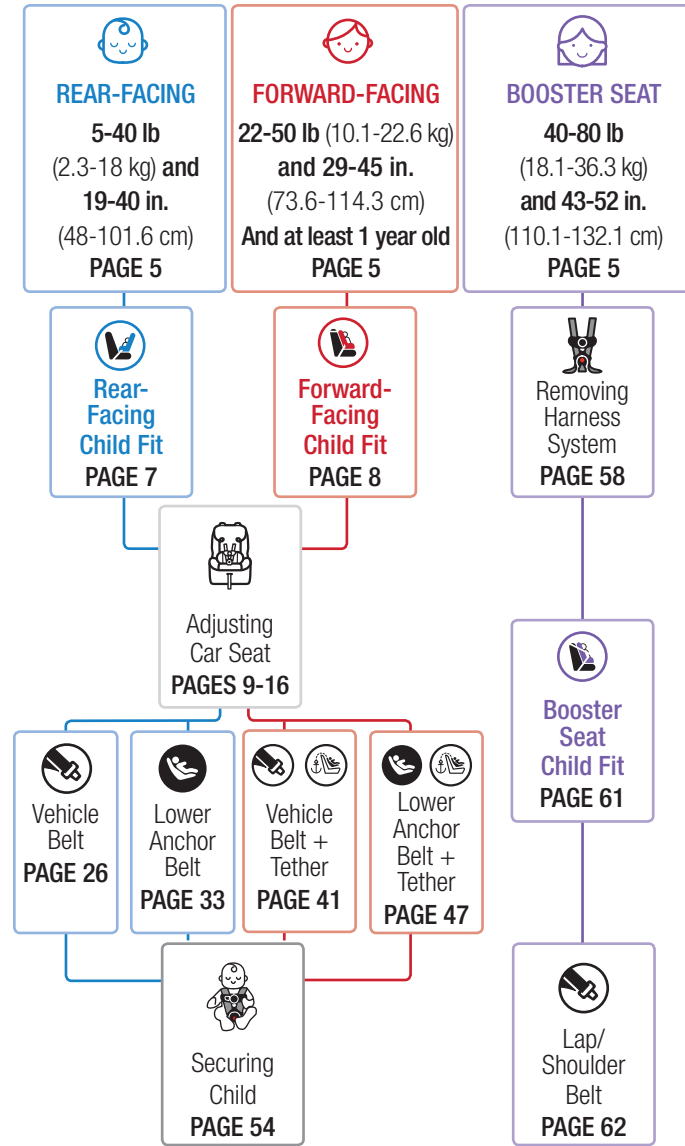

Contents

Getting Started

Parts of Car Seat	1
Accessory Use	3
Choosing Car Seat Mode	4
Preparing Car Seat for Child Fit	6
Rear-Facing Child Fit	7
Forward-Facing Child Fit	8

Making Adjustments to Car Seat

Changing Headrest/Harness Height	9
Changing Buckle Position	10
Harness System Adjustments For Smaller Infants	12
Reclining Car Seat	16

Choosing LATCH or Vehicle Belt

LATCH: Lower Anchor Use	17
Vehicle Belts	19
Tether Use	23

Installation in Vehicle

Rear-Facing Mode	25
Vehicle Belt Install	26
LATCH: Lower Anchor Belt Install	33
Forward-Facing Mode	40
Vehicle Belt + Tether Install	41
LATCH: Lower Anchor Belt + Tether Install	47

Securing Child in Car Seat

Booster Seat

Booster Seat Mode	57
Removing Harness System	58
Booster Seat Child Fit	61
Lap/Shoulder Belt Use	62

Car Seat Pad Use and Care

Removing Seat Pad Set for Cleaning	64
Cleaning and Installing Seat Pad Set	66
Installing Harness System	67

Safety Information

Aircraft Information	70
Replacement and Expiration of Car Seat	71
Child Restraint Use	72
Installation in Vehicle	72
Vehicle Seating Position	73
Registration and Safety Notices	74

Additional Information

Warranty	75
Troubleshooting	76
Replacement Parts List	77
Dorel Juvenile Group Information	78

1



Parts of Car Seat

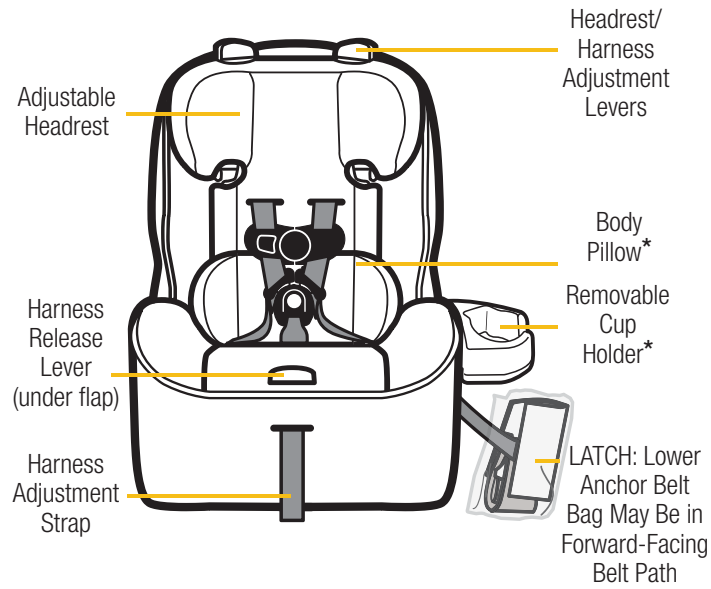

2

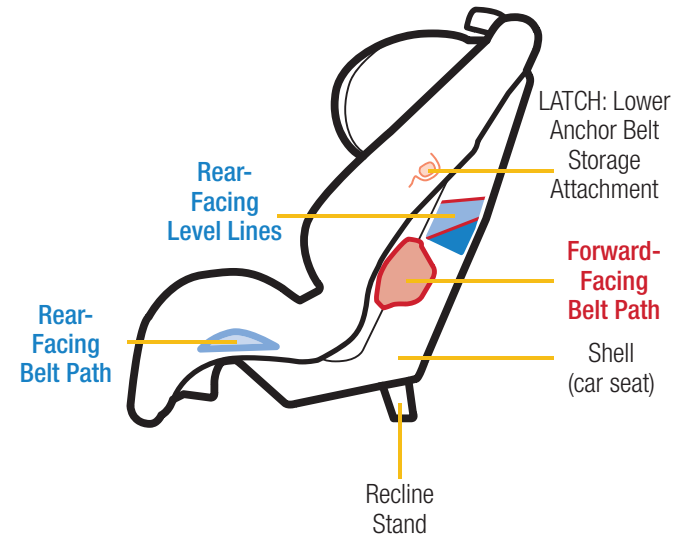

Harness System Detail

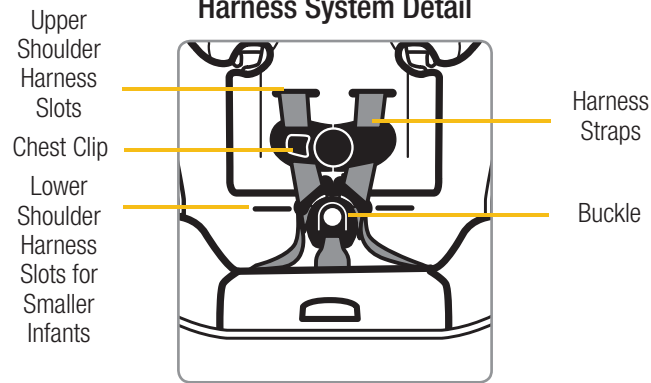

*See page 3 for Accessory Use.

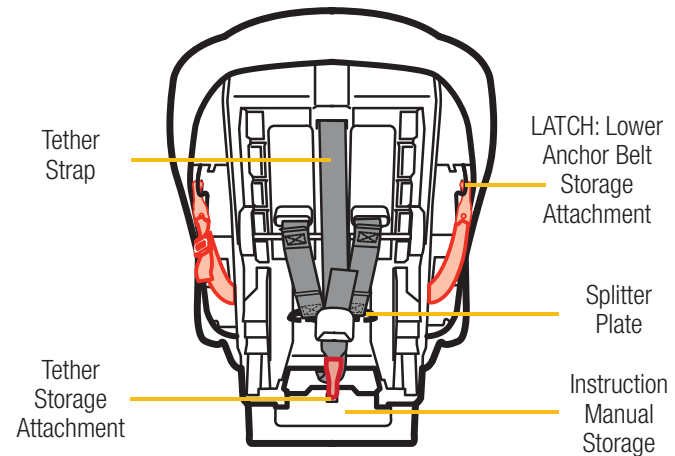



Accessory Use



For Use in **Rear-Facing Mode Only**



Body Pillow

To remove, slide it out from behind the harness straps.



For Use in All Modes

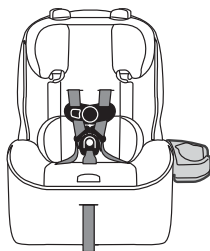

Removable Cup Holder

To install, pull the seat pad off the corner of the shell.

Hook the bottom of the cup holder to the edge of the shell.

Rotate the cup holder up until it snaps into the hole in the shell.

Replace the seat pad.

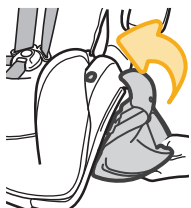

Choosing Car Seat Mode



Measure your child's weight and height (do not guess) before choosing the car seat's mode.

Your child's height, weight, and age determine how the car seat should be placed in the vehicle.

Children vary widely in body size, shape, and temperament—**please consult your doctor before switching between any of these modes within the limits and fit requirements of the seat.**

State Laws

Please be certain to follow your state's laws regarding car seat use.

American Academy of Pediatrics Recommendations

Infants and Toddlers

Should ride in a rear-facing car seat as long as possible, until they reach the highest weight or height allowed by their seat.

Toddlers and Preschoolers

Once they are facing forward, children should use a forward-facing car seat with a harness for as long as possible, until they reach the height and weight limits for their seats.

School-Aged Children

Once they have outgrown their forward-facing car seat, children should use a belt-positioning booster seat until the vehicle's lap and shoulder seat belt fits properly. This is often when they have reached at least 4 feet 9 inches in height and are 8 to 12 years old.

Older Children

All children younger than 13 years should be restrained in the rear seats of vehicles for optimal protection.

continued on next page



REAR-FACING MODE

5-40 lb (2.3-18 kg) and 19-40 in. (48-101.6 cm)

Children under 1 year of age must ride **Rear-Facing**.

In this car seat, your child can remain **Rear-Facing** until they outgrow any one of the following:

- **Weight Limit:** 40 lb (18 kg); **OR**
- **Height Limit:** 40 in. (101.6 cm); **OR**
- **Rear-Facing Child Fit** requirements, see page 7



FORWARD-FACING MODE

22-50 lb (10.1-22.6 kg) and 29-45 in. (73.6-114.3 cm)

Children must be at least 1 year of age to ride **Forward-Facing**.

In this car seat, your child can remain harnessed **Forward-Facing** until they outgrow any one of the following:

- **Weight Limit:** 50 lb (22.6 kg); **OR**
- **Height Limit:** 45 in. (114.3 cm); **OR**
- **Forward-Facing Child Fit** requirements, see page 8



BOOSTER SEAT MODE

40-80 lb (18.1-36.3 kg) and 43-52 in. (110.1-132.1 cm)

In this car seat, your child can remain in a **Booster Seat** until they outgrow any one of the following:

- **Weight Limit:** 80 lb (36.3 kg); **OR**
- **Height Limit:** 52 in. (132.1 cm); **OR**
- **Booster Seat Child Fit** requirements, see page 61

Preparing Car Seat for Child Fit



1

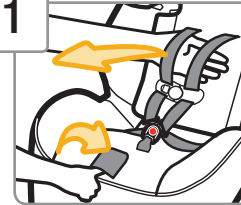

Fully Loosen Harness Straps

Push down on the harness release lever (through the opening in the pad) while pulling out on the harness straps as shown.

2

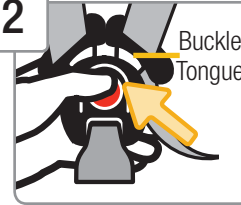

Unbuckle Harness

Press in towards the **top** of the red button and pull out the buckle tongues.

3

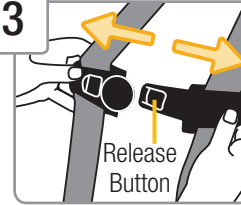

Release Chest Clip

Hold each side of the chest clip. Press on the release button with your thumb and pull the chest clip apart. Place the harness straps out of the way.

4

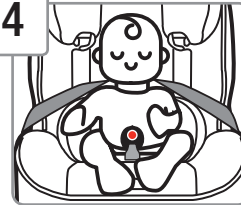

Place Child in Car Seat to Determine Proper Harness Fit

Your child's bottom and back should be flat against the car seat.

For **Rear-Facing Child Fit**, see page 7.

For **Forward-Facing Child Fit**, see page 8.



Rear-Facing Child Fit

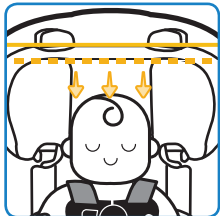

Head Position

The top of your child's head **must be at least 1 in. (2.5 cm) below** the top of the car seat's headrest.

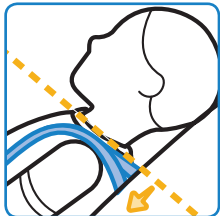

Harness Strap Position

The harness strap **must be at or slightly below** your child's shoulders; **never above**.

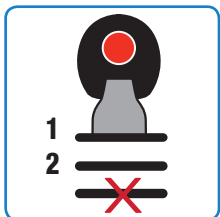

Do not use 3rd slot in **Rear-Facing Mode**.

Buckle Position

The buckle **must be** used in either the **1st or 2nd** buckle slot.

Choose the slot closest to your child.

The buckle **should not be underneath or behind** your child.

Need to make adjustments?

To change headrest/harness height, see page 9.

To change buckle position, see pages 15-16.

Forward-Facing Child Fit

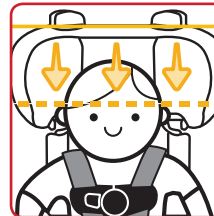

Head Position

The tops of your child's ears **must be below** the top of the car seat's headrest.

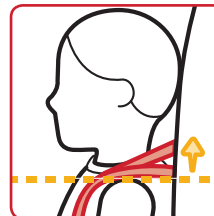

Harness Strap Position

The harness strap **must be at or slightly above** your child's shoulders; **never below**.



Max Seated Shoulder Height

In this car seat, the maximum seated shoulder height is **17 in. (43.2 cm)**.

To measure your child's seated shoulder height: have them sit on the floor with their back flat against a wall. Then measure from the floor up to the top of their shoulder.

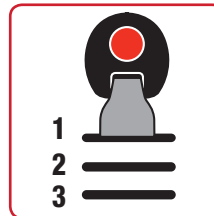

Buckle Position

The buckle can be used in **any** buckle slot.

Choose the slot closest to your child.

The buckle **should not be underneath or behind** your child.

Need to make adjustments?

To change headrest/harness height, see page 9.

To change buckle position, see pages 15-16.



Changing Headrest/ Harness Height

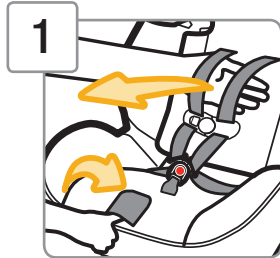

1 Fully Loosen Harness Straps

Push down on the harness release lever (through the opening in the pad) while pulling out on the harness straps as shown.

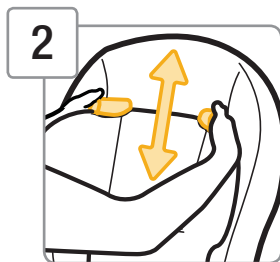

2 Changing Headrest/ Harness Height

Rotate the headrest/harness adjustment levers inward.

Move the headrest up or down to the proper height for your child.

Make sure it locks securely.

For **Rear-Facing Child Fit**, see page 7.

For **Forward-Facing Child Fit**, see page 8.

Check your child's fit often.

If you cannot achieve a snug harness fit for your child, see pages 12-15.

To learn how to check harness tightness, see pages 54-56.

Check the harness straps often for any wear or damage.

Changing Buckle Position

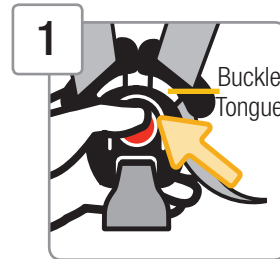

1 Unbuckle Harness

Press in towards the **top** of the red button and pull out the buckle tongues.

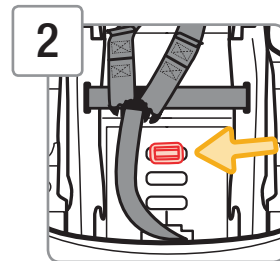

2 Turn Car Seat Over

Locate the buckle's metal retainer on the bottom of the shell.

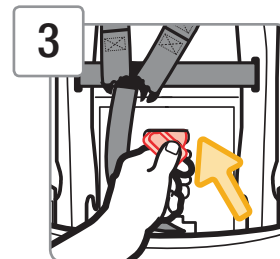

3 Rotate Metal Retainer and Push It Up Through Buckle Slot in Shell



4 From Top of Car Seat, Pull Buckle Out of Shell and Pad

continued on next page



5

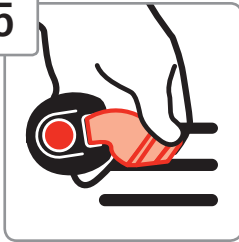

Insert Buckle's Metal Retainer into Buckle Slot Closest to Child

The buckle **must** face out.

Rear-Facing Mode: You **must** use the 1st or 2nd buckle slot.

Forward-Facing Mode: Any slot can be used.

6

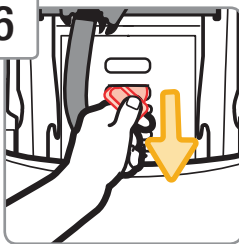

Pull Metal Retainer Completely Through Pad and Shell

7



Check Buckle

Pull up on the buckle to make sure it is secured.

The buckle **must not** pull out.

Check your child's fit often.

If you cannot achieve a snug harness fit for your child, see pages 12-15.

To learn how to check harness tightness, see pages 54-56.

⚠️ Failure to place buckle's metal retainer completely through pad and shell can result in serious injury or death.

Harness System Adjustments for Smaller Infants

If you cannot achieve a snug harness fit for your child, you may need to adjust the buckle strap and harness strap length as shown in this section.

Adjusting Buckle Strap

1

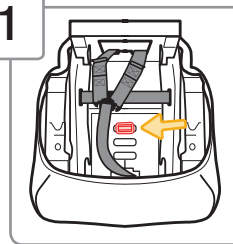

With Buckle in 1st Slot, Turn Car Seat Over

If you need to move the buckle to the 1st slot, see pages 10-11.

2

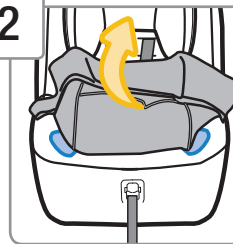

Pull Up Front of Car Seat Pad

3

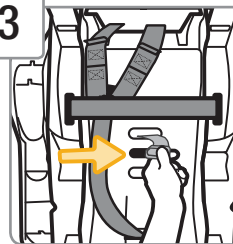

From Bottom of Seat, Pull Metal Retainer Towards You and Push It Up into Middle Slot As Shown

continued on next page

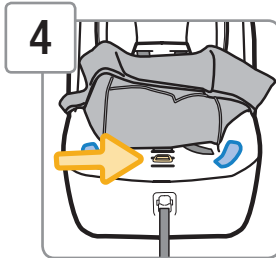

4 From Top of Car Seat, Lay Metal Retainer Flat Against Shell As Shown



5 Replace Pad and Check Buckle
Pull up on buckle to make sure it is secured.
The buckle **must not** pull out.

Check your child's fit often.

To learn how to check harness tightness, see pages 54-56.

Adjusting Harness Strap

When using the lower shoulder harness slots for smaller children, you must use the body pillow and the headrest must be in the lowest position.

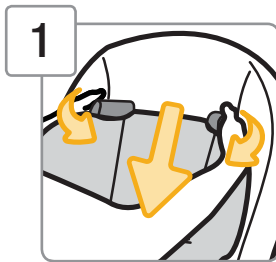

1 Adjust Headrest to Lowest Position

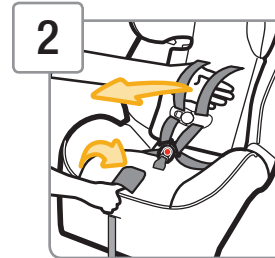

2 Fully Loosen Harness Straps

Push down on the harness release lever (through the opening in the pad) while pulling out on the harness straps as shown.

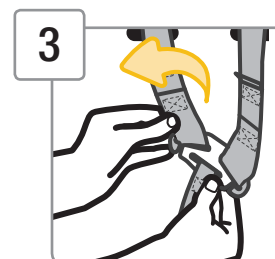

3 From Back of Car Seat, Remove Harness Strap Loops From Splitter Plate

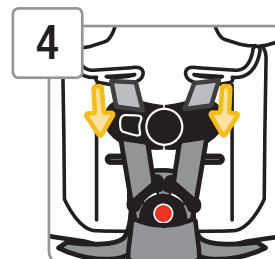

4 Pull Harness Straps Out of Upper Shoulder Harness Slots

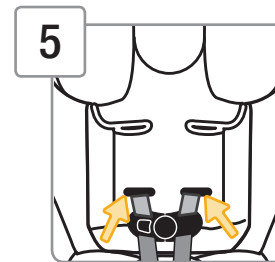

5 Thread Harness Straps Through Lower Shoulder Harness Slots For Smaller Infants in Seat Pad and Shell

continued on next page

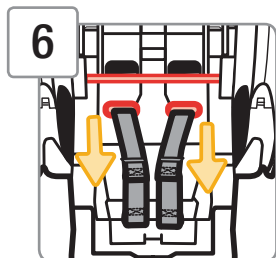

6 From Back of Car Seat, Pull Harness Straps Through Shell

The harness straps **must** be in the shoulder harness slots **below** the metal bar as shown.

Do not twist the harness straps.

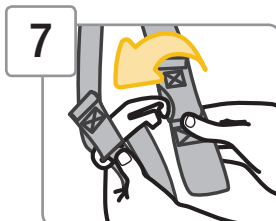

7

Attach 2nd Harness Strap Loops to Splitter Plate As Shown

The sewn ends of the harness strap loops **must** face towards you.

Do not twist the harness strap or the harness adjustment strap.

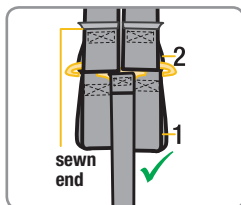

Make sure the same harness strap loops are fitted **completely on** both sides of the splitter plate.

Check your child's fit often.

To learn how to check harness tightness, see pages 54-56.

⚠ The harness system must be installed correctly. Do not use a child restraint with damaged harness straps.



This car seat has 2 positions.

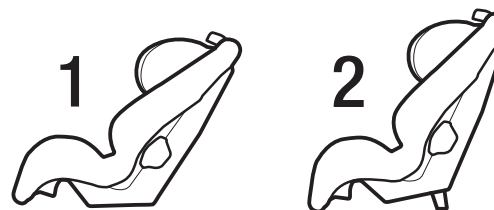

Rear-Facing Mode - 1 Reclined

For children between 5-22 lb (2.3-10 kg), the bottom level line on the shell **must be** parallel with the ground.

For children 22-40 lb (10.1-18 kg) who can sit up unassisted, rotate the car seat between the 2 level lines.

Forward-Facing Mode - 2 Upright

Booster Seat Mode - 2 Upright

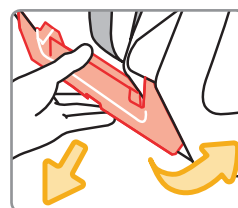

To Recline: Pull the recline stand down and rotate it under the car seat.

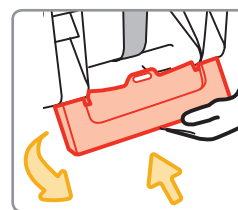

For Upright: Rotate the recline stand out and push it upward to lock it into position.



For Use in **Rear-Facing Mode**
or **Forward-Facing Mode**

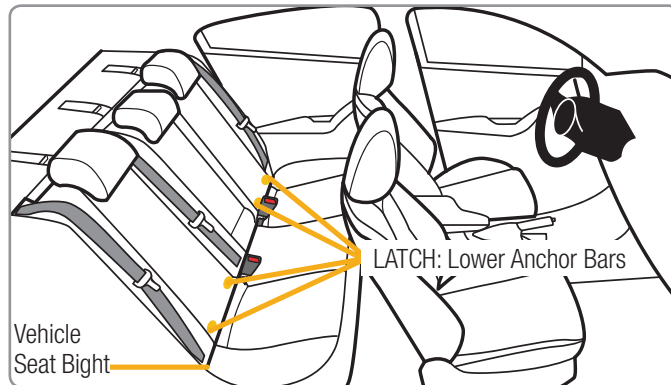

Your vehicle's features may be considerably different than those pictured here.

The lower anchors of **LATCH** (Lower Anchors and Tethers for **CH**ildren) is a universal system for installing car seats without using vehicle seat belts.

The LATCH: lower anchor belt can **only** be used in vehicles that have the lower anchor bars installed in designated seating positions. Most vehicles manufactured after September 2002 are equipped with LATCH: lower anchor bars.

Check your vehicle owner's manual to see which seating positions may be equipped with LATCH: lower anchor bars.

⚠ Do not use both the lower anchor belt and vehicle belt at the same time. When used correctly the lower anchor belt or the vehicle belts are equally safe.

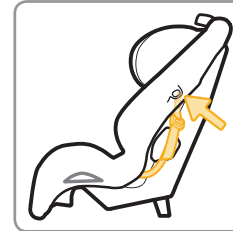

Lower Anchor Belt Storage Attachment

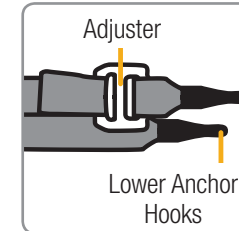

Lower Anchor Belt Parts

To Remove Lower Anchor Belt from Storage Attachment on Car Seat

Squeeze the spring lever on the hooks and remove the hooks from the storage attachments.

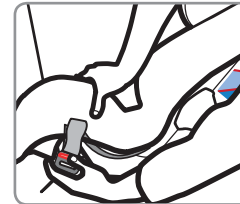

To Remove Lower Anchor Belt from Vehicle's Lower Anchor Bars

Remove the tension from the belt by pushing down on the side of the car seat with the adjuster. Then press the adjuster's button to loosen the belt.

Remove the hook from the anchor by squeezing the spring lever on the hook, pushing the hook back into the seat bight, and rotating the hook to the side. Then pull the hook out of the vehicle seat bight.

To Store Lower Anchor Belt

When using the vehicle belts to install, using the **Booster Seat Mode**, or when the car seat is not installed in a vehicle, the lower anchor belt must be properly stored in its storage location.

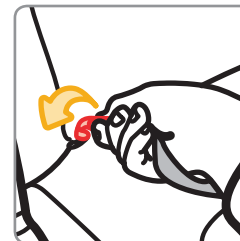

Lower Anchor Belt Storage Location

Thread the lower anchor belt through the **Forward-Facing Belt Path** then attach the hooks to the storage attachments as shown. Gently tighten to remove slack.

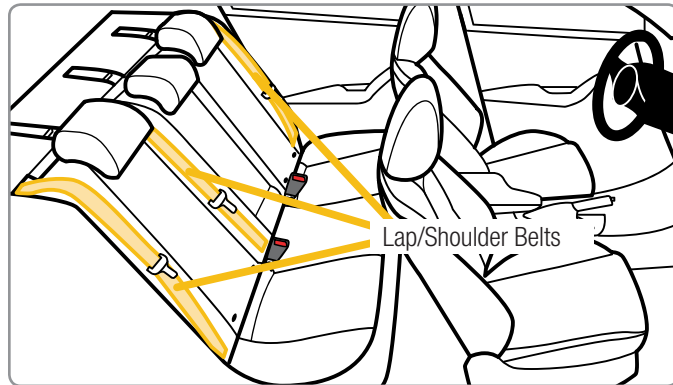

Your vehicle's features may be considerably different than those pictured here.

If LATCH: lower anchors are not an option or if your child weighs more than **40 lb** (18 kg), you must use the vehicle seat belt system to install the car seat.

Not all vehicle belts and seating positions will work with car seats.

Please go through the steps following steps to understand how to lock a car seat in **Rear-Facing Mode** or **Forward-Facing Mode** with a vehicle belt.



1



You Must Review Your Vehicle Owner's Manual

Your vehicle owner's manual will let you know which vehicle belts and seating positions car seats can be installed in.

2



Check How This Car Seat Will Be Locked Into Place

The vehicle belt **must not** loosen after tightening. This means there needs to be a way to lock the vehicle belt.

The ways this can be done are:

- By using the seat belt's retractor, see step 3; **OR**
- By using the seat belt's latch plate, see step 4.

3

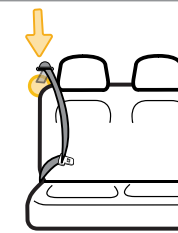

Check Retractor

Retractors pull seat belts into stored positions and lock the belt to hold passengers in place.

See the next page for some common types of vehicle belt retractors that will work with this car seat.

continued on next page



Types of Retractors

Switchable Retractor (most vehicles have this type)



This retractor can be switched to a locking mode.

You **must have the retractor in the locking mode** to use the seat belt with this car seat.

Switching to locking mode: Slowly pull the shoulder belt all the way out, then let it go back in **1-2 in.** (2.5-5 cm).

As it goes back in, you will most likely hear a ratcheting sound.

Gently pull the belt to see if it has locked. You will not be able to pull any more belt out if the lock has engaged.

Automatic Locking Retractor



This retractor always locks.

It will automatically lock after slowly pulling the seat belt out at least halfway and letting the belt go back into the retractor **1-2 in.** (2.5-5 cm).

Emergency Locking Retractor

See Step 4, “Check the Latch Plates”.

If the retractor does not lock, it is most likely an Emergency Locking Retractor. These retractors only lock during a sudden stop or collision.

You will need to determine if your seat belt’s latch plate can lock the belt. See step 4, “Check the Latch Plates”.



4

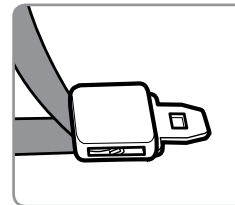
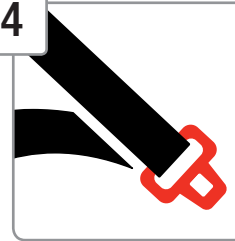

Locking Latch Plate

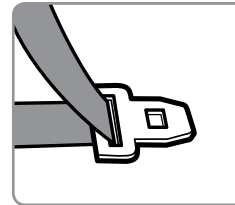

Emergency Locking Retractor with a Sliding Latch Plate

Check Latch Plates

Latch plates are the part of the seat belt that goes into the buckle.

To see if the latch plate locks:

1. Buckle Vehicle Belt
2. Firmly Tug Lap Portion of Seat Belt While Pulling It Up

If the vehicle belt does not slide through the latch plate, it’s locked.

If the latch plate slides up and down the vehicle belt, it is a **sliding latch plate**.

Sliding latch plates easily slip between the lap and shoulder portions of the belt.

If you have an Emergency Locking Retractor with a Sliding Latch Plate, you must use a locking clip.

Please contact us for one, see page 77.

Never Use With This Car Seat

Emergency Locking Retractor Lap Only Belt



Inflatable Seat Belts





For **Forward-Facing Mode** Only

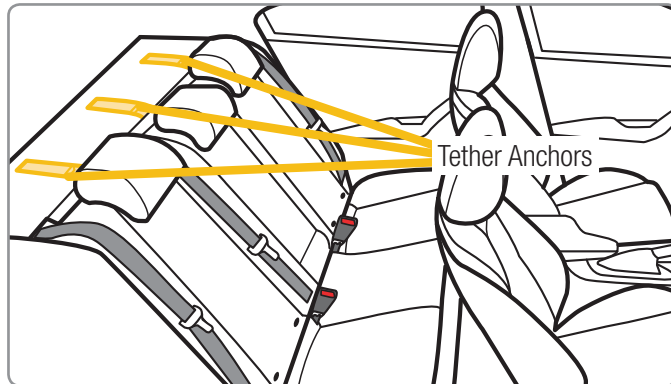

Your vehicle's features may be considerably different than those pictured here.

You **must always attach, adjust, and secure the tether (top anchorage) strap** when installing the car seat in the **Forward-Facing Mode** with internal harness. Tethers improve the installation and stability of car seats and reduce the risk of injury.

Attach the tether hook to the tether anchor designated by your vehicle manufacturer for that seating position. Check your vehicle owner's manual for more information.

If the seating position does not have a tether anchor, use a different seating position or see your dealer or a qualified mechanic and have one installed.

⚠ Using this child restraint without the tether strap anchored as required by the manufacturer would be a misuse of the child restraint and, in a sudden stop or crash, could result in serious injury or death.

Do not fasten multiple tether hooks on the same tether anchor in the vehicle.



Storing Tether Strap

When installing in the **Rear-Facing Mode**, using the **Booster Seat Mode**, or when the car seat is not installed in a vehicle, attach the tether hook to its storage attachment on the back of the car seat as shown. Gently tighten to remove slack.

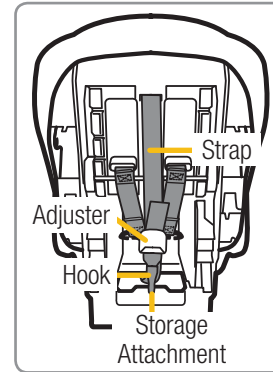

Tether Storage and Parts

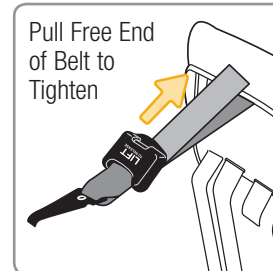

Adjusting Tether Strap

To tighten: After the car seat is locked into place with the lower anchor belt or vehicle belt, push down on the car seat and gently pull on the free end of the tether strap.

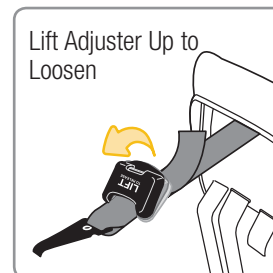

To loosen: Lift up on the tether adjuster and push it towards the tether hook.



5-40 lb (2.3-18 kg) and **19-40 in.** (48-101.6 cm)



Lap/Shoulder
Belt



Lap Belt



LATCH: Lower
Anchor Belt



Never install a rear-facing child restraint in the front seat of a vehicle equipped with an active frontal airbag.

Do not use the tether for rear-facing mode. Secure the tether strap hook to its storage attachment.

Do not use the lower anchor belt along with the vehicle lap or lap/shoulder belt.

Check the vehicle belt or the lower anchor belt before each use. Use only if the belt can be tightened properly and locked securely in place.

Do not fasten multiple lower anchor hooks on the same lower anchor bar in the vehicle.

This child restraint must always face the rear of the vehicle until the child is at least 1 year old and weighs 22 lb (10 kg).



Before you begin installing the car seat into your vehicle, did you check:



Your child's weight and height?

5-40 lb (2.3-18 kg) and
19-40 in. (48-101.6 cm)



Your child's fit? See page 7.

Do you need to make adjustments to the harness/headrest height or the buckle position?

Store Tether

Loosely attach the tether hook to the storage attachment before folding the recline stand. Then gently tighten the tether strap to remove slack.

1

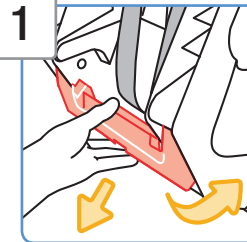

Recline Car Seat

Pull down the recline stand to unlock and fold it under the car seat.

continued on next page

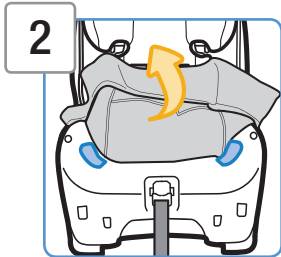

2 Pull Seat Pad Off Front of Car Seat

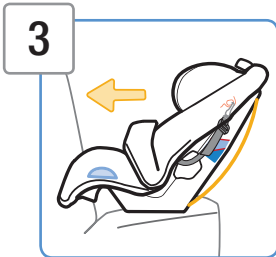

3 Place Car Seat **Rear-Facing** in Back Seat

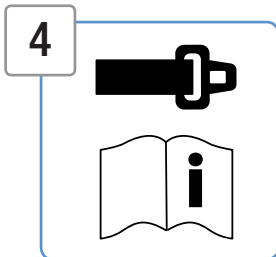

4 Check if Your Vehicle Belts Will Work With This Car Seat

This is very important because **not all vehicle belts will work with car seats.**

Review pages 19-22 and your vehicle owner's manual to find out what kind of vehicle belts you have and how to lock a car seat in place.

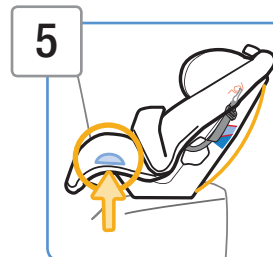

5 Locate **Rear-Facing Belt Path**

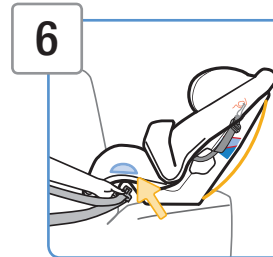

6 Route Vehicle Belt

Thread the vehicle belt through the **Rear-Facing Belt Path** opening as shown.

The belt goes:

- across the car seat; **AND**
- under the car seat pad; **AND**
- in front of the buckle; **AND**
- out the other **Rear-Facing Belt Path** opening.

Do not twist belt.

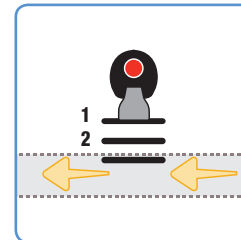



7

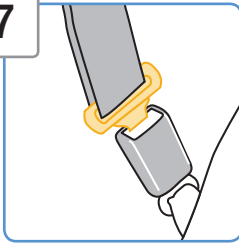

Buckle Vehicle Belt

8

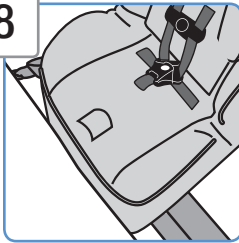

Replace Seat Pad Around Front of Car Seat

9

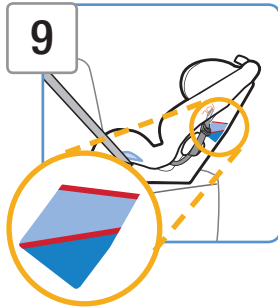

Check Rear-Facing Level Line

For children between 5-22 lb (2.3-10 kg), the bottom level line on the shell **must be** parallel with the ground.

For children 22-40 lb (10.1-18 kg) who can sit up unassisted, rotate the car seat between the 2 level lines.

Start by making the bottom level line parallel with the ground, then rotate seat up. **Do not** rotate past the top level line.



10

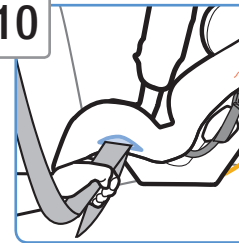

Tighten Belt

Place your hand in the car seat.

Firmly push the car seat down and back towards the vehicle seat back while pulling the shoulder belt or the free end of lap belt parallel with the **Rear-Facing Belt Path** as shown.

11

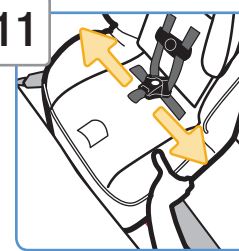

Check Belt Tightness

Hold the car seat at the **Rear-Facing Belt Path** with your weaker hand.

Push and pull the car seat from side to side. It should not move more than **1 in. (2.5 cm)**.

If it moves more than 1 in. (2.5 cm), you can try:

- Pulling the belt tighter; **OR**
- Reinstalling the car seat; **OR**
- Changing to a different seating location; **OR**
- Switching to LATCH: lower anchor belt installation if lower anchors are available in your vehicle



12



Secure Child in Car Seat

To properly secure your child in the car seat, see pages 54-56.

Check your child's fit often and make any needed adjustments to the car seat as they grow.

13

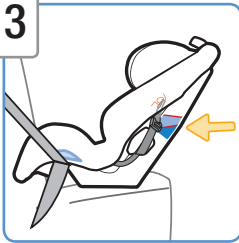

Recheck **Rear-Facing Level Line**

Redo the installation if the car seat is not reclined correctly for your child.

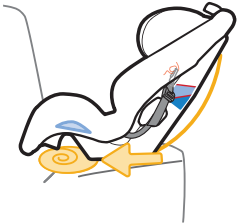

You may need to place a tightly rolled towel(s) or foam pool noodle(s) under the front of the car seat to help get the correct recline angle for the **Rear-Facing Level Line**.

Check often to make sure padding is still in place and the belt is tight.

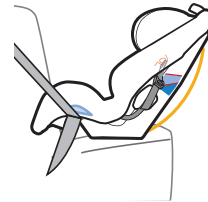

Finished!

Check the tightness of the install often to make sure it has not loosened.



Before you begin installing the car seat into your vehicle, did you check:



Your child's weight and height?

**5-40 lb (2.3-18 kg) and
19-40 in. (48-101.6 cm)**



Your child's fit? See page 7.

Do you need to make adjustments to the harness/headrest height or the buckle position?

1

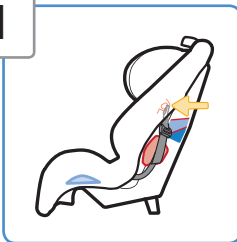

Remove Lower Anchor Belt from Storage Attachments

Or if the lower anchor belt was used **Forward-Facing**, remove it from the **Forward-Facing Belt Path** so both hooks are on the same side of the car seat as shown.

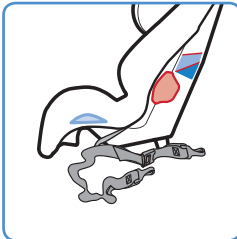

Store Tether

Loosely attach the tether hook to the storage attachment before folding the recline stand. Then gently tighten the tether strap to remove slack.



2

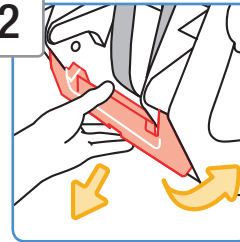

Recline Car Seat

Pull down the recline stand to unlock and fold it under the car seat.

3

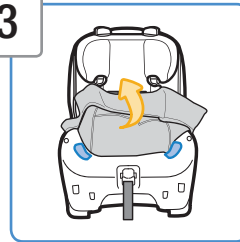

Pull Seat Pad Off Front of Car Seat

4

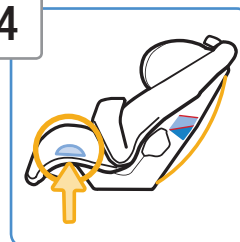

Locate Rear-Facing Belt Path



5

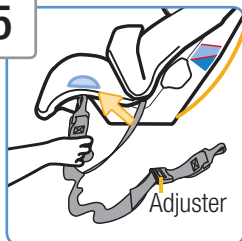

Finished Lower Anchor
Belt Routing

Route Lower Anchor Belt

Thread the hook through the **Rear-Facing Belt Path** opening as shown.

The adjuster can be on either side of the car seat.

The belt goes:

- across the car seat; **AND**
- under the car seat pad; **AND**
- in front of the buckle; **AND**
- out the other **Rear-Facing Belt Path** opening.

Replace the seat pad around the front of the car seat.

Do not twist belt.

6

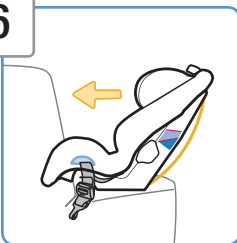

Place Car Seat **Rear-Facing**
in Back Seat



7

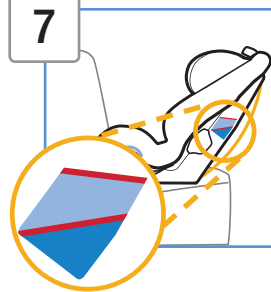

Check **Rear-Facing Level Line**

For children **between 5-22 lb (2.3-10 kg)**, the bottom level line on the shell **must be** parallel with the ground.

For children **22-40 lb (10.1-18 kg) who can sit up unassisted**, rotate the car seat between the 2 level lines.

Start by making the bottom level line parallel with the ground, then rotate seat up. **Do not** rotate past the top level line.

8

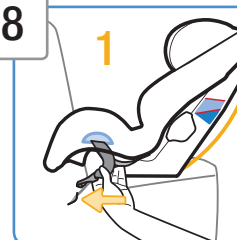

Attach Lower Anchor Hooks to Vehicle's Lower Anchors in Seat Bight

Review your vehicle owner's manual for LATCH: lower anchor locations and lower anchor belt use.

Fasten one hook to one vehicle lower anchor bar.

Then repeat for the second hook on the other side of the car seat.

continued on next page



9

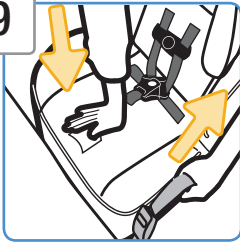

Tighten Belt

Place your hand in the car seat. Firmly push the car seat down and back towards the vehicle seat back while pulling the free end of the belt parallel with the **Rear-Facing Belt Path** as shown.

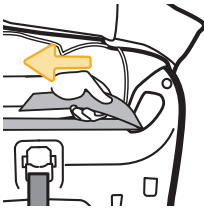

It may be easier to tighten the belt by pulling the free end of the belt towards you and parallel with the belt path as shown.

10

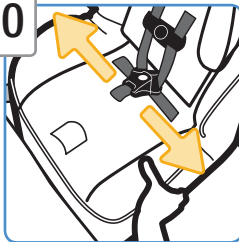

Check Belt Tightness

Hold the car seat at the **Rear-Facing Belt Path** with your weaker hand. Push and pull the car seat from side to side. It should not move more than **1 in. (2.5 cm)**.

11

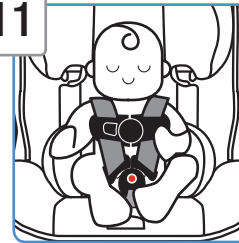

Secure Child in Car Seat

To properly secure your child in the car seat, see pages 54-56. Check your child's fit often and make any needed adjustments to the car seat as they grow.

12

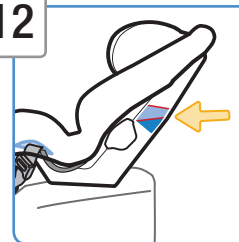

Recheck **Rear-Facing Level Line**

Redo the installation if the car seat is not reclined correctly for your child.



If it moves more than **1 in. (2.5 cm)**, you can try:

- Pulling the belt tighter; **OR**
- Reinstalling the car seat; **OR**
- Changing to a different seating location; **OR**
- Switching to vehicle belt installation

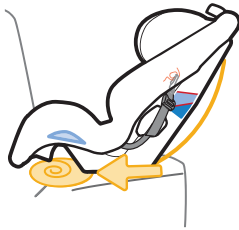

You may need to place a tightly rolled towel(s) or foam pool noodle(s) under the front of the car seat to help get the correct recline angle for the **Rear-Facing Level Line**.

Check often to make sure padding is still in place and the belt is tight.

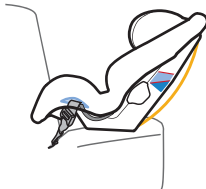

Finished!

Check the tightness of the install often to make sure it has not loosened.



**22-50 lb (10.1-22.6 kg) and 29-45 in. (73.6-114.3 cm)
and at least 1 year old**

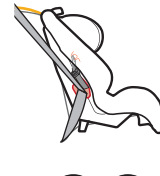

Lap/Shoulder
Belt and Tether

Up to 50 lb
(22.6 kg)



Lap Belt
and Tether

Up to 50 lb
(22.6 kg)

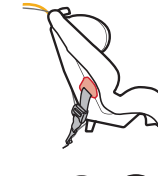

LATCH: Lower Anchor
Belt and Tether

Do not install by this
method for a child
weighing more than
40 lbs (18 kg).



Do not use the lower anchors of the child restraint anchor-age system (LATCH system) to attach this child restraint when restraining a child weighing more than 40 lbs (18 kg).

The vehicle belt must be used for installation if your child weighs more than 40 lb (18 kg).

Do not use the lower anchor belt along with the vehicle lap or lap/shoulder belt.

Check the vehicle belt or the lower anchor belt before each use. Use only if the belt can be tightened properly and locked securely in place.

Do not fasten multiple lower anchor hooks on the same lower anchor bar in the vehicle.

In this child restraint your child must be at least 1 year old and weigh 22 lb (10 kg) before they sit forward-facing.



Before you begin installing the car seat into your vehicle, did you check:



Your child's weight and height?

**22-50 lb (10.1-22.6 kg) and
29-45 in. (73.6-114.3 cm)**



Your child's fit? See page 8.

Do you need to make adjustments to the harness/headrest height or the buckle position?

1

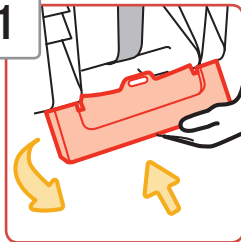

Place Car Seat into Position 2

Rotate the recline stand out and push it up to lock it into place.

2

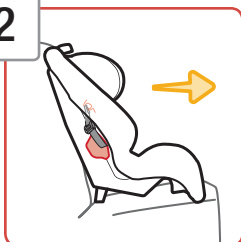

Place Car Seat Forward-Facing in Back Seat



3



Make Car Seat Flush Against Vehicle Seat

The vehicle seat back must be upright.

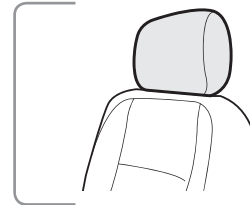

If your vehicle seat's headrest interferes with a flush car seat fit, check your vehicle owner's manual to see if the headrest can be removed, adjusted, or if there are other possible seating locations to use the car seat.

4



Loosely Attach Tether Hook to Vehicle's Tether Anchor

Check your vehicle owner's manual for specific tether (top anchorage) anchor locations.



5

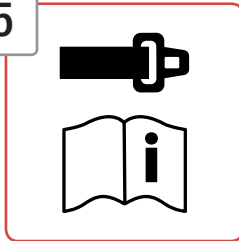

Check if Your Vehicle Belts Will Work With This Car Seat

This is very important because **not all vehicle belts will work with car seats.**

Review pages 19-22 and your vehicle owner's manual to find out what kind of vehicle belt you have and how to lock a car seat in place.

6

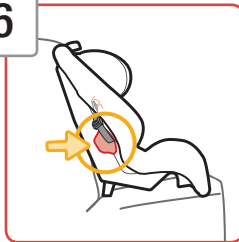

Locate **Forward-Facing Belt Path**

7

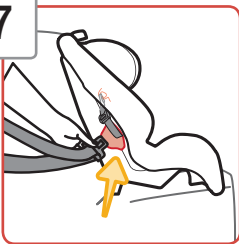

Route Vehicle Belt

Thread the vehicle belt through the **Forward-Facing Belt Path** opening as shown. **The belt goes:**

- across the car seat; **AND**
- under the car seat pad; **AND**
- out the other **Forward-Facing Belt Path** opening.

Do not twist belt.



8

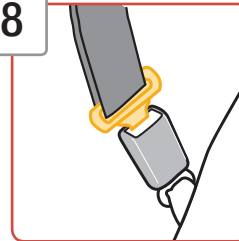

Buckle Vehicle Belt

9

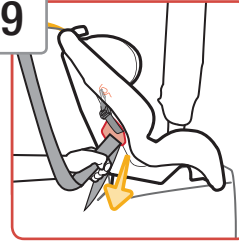

Tighten Belt

Place your hand in the car seat.

Firmly push the car seat down and back towards the vehicle seat back while pulling the shoulder belt or the free end of lap belt parallel with the **Forward-Facing Belt Path** as shown.

continued on next page



10

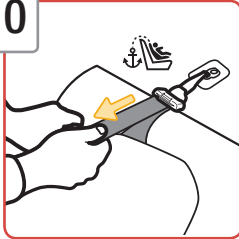

Tighten Tether

Push firmly on the back of the car seat and pull the free end of the tether strap to remove all of the slack.

11

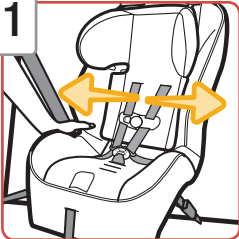

Check Belt Tightness

Hold the car seat at the **Forward-Facing Belt Path** with your weaker hand.

Push and pull the car seat from side to side. It should not move more than **1 in.** (2.5 cm).

- **If it moves more than 1 in. (2.5 cm), you can try:**
- Putting your knee in the car seat and pulling the belt tighter; **OR**
- Reinstalling the car seat; **OR**
- Changing to a different seating location; **OR**
- Switching to LATCH: lower anchor belt installation if lower anchors are available in your vehicle

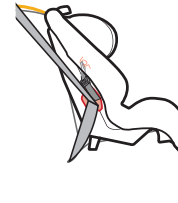

Finished!

Check the tightness of the install often to make sure it has not loosened.



Securing Child in Car Seat

To properly secure your child in the car seat, see pages 54-56.

Check your child's fit often and make any needed adjustments to the car seat as they grow.



LATCH: Lower Anchor + Tether Install

Before you begin installing the car seat into your vehicle, did you check:



Your child's weight and height?

22-40 lb (10.1-18 kg) and
29-45 in. (73.6-114.3 cm)



Your child's fit? See page 8.

Do you need to make adjustments to the harness/headrest height or the buckle position?

⚠️ Do not use the lower anchors of the child restraint anchorage system (LATCH system) to attach this child restraint when restraining a child weighing more than 40 lbs (18 kg).

1

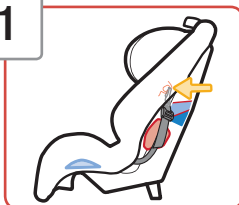

Remove Lower Anchor Belt from Storage Location

Or if the lower anchor belt was used **Rear-Facing**, remove the belt from the **Rear-Facing Belt Path** so both hooks are on the same side of the car seat as shown.

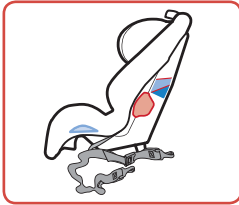

2

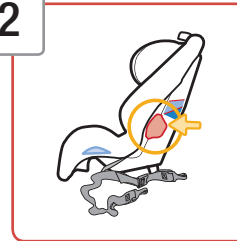

Locate **Forward-Facing Belt Path**

3

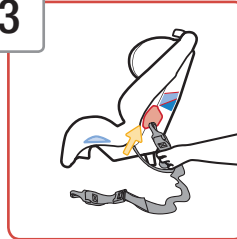

Route Lower Anchor Belt

Thread the hook through the **Forward-Facing Belt Path** opening as shown. The adjuster can be on either side of the car seat.

The belt goes:

- across the car seat; **AND**
- under the car seat pad; **AND**
- out the other **Forward-Facing Belt Path** opening.

Do not twist belt.



Finished Lower Anchor Belt Routing



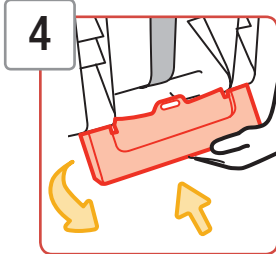

4 Place Car Seat into Position 2

Rotate the recline stand out and push it up to lock it into place.

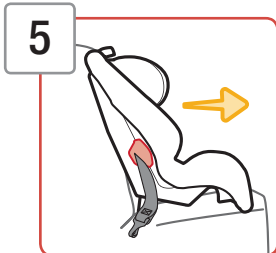

5 Place Car Seat **Forward-Facing** in Back Seat

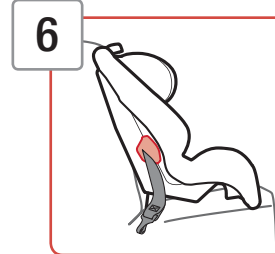

6 Make Car Seat Flush Against Vehicle Seat

The vehicle seat back must be upright.

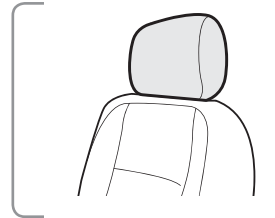

If your vehicle seat's headrest interferes with a flush car seat fit, check your vehicle owner's manual to see if the headrest can be removed, adjusted, or if there are other possible seating locations to use the car seat.



7 Loosely Attach Tether Hook to Vehicle's Tether Anchor

Check your vehicle owner's manual for specific tether (top anchorage) anchor locations.

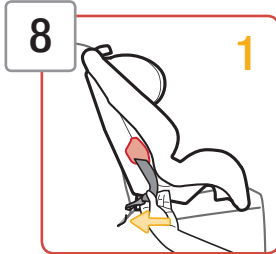

8

1

Attach Lower Anchor Hooks to Vehicle's Lower Anchors in Seat Bight

Review your vehicle owner's manual for LATCH: lower anchor locations and lower anchor belt use.

Fasten one hook to one vehicle lower anchor bar.



2

Then repeat for the second hook on the other side of the car seat.

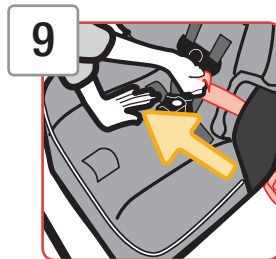

9

Tighten Belt

Place your hand in the car seat.

Firmly push the car seat down and back towards the vehicle seat back while pulling the free end of the belt parallel with the **Forward-Facing Belt Path** as shown.

10



Tighten Tether

Push firmly on the back of the car seat and pull the free end of the tether strap to remove all of the slack.

11



Check Belt Tightness

Hold the car seat at the **Forward-Facing Belt Path** with your weaker hand.

Push and pull the car seat from side to side. It should not move more than **1 in.** (2.5 cm).

If it moves more than 1 in. (2.5 cm), you can try:

- Putting your knee in the car seat and pulling the belt tighter; **OR**
- Reinstalling the car seat; **OR**
- Changing to a different seating location; **OR**
- Switching to vehicle belt installation



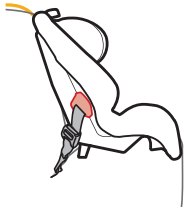

Finished!

Check the tightness of the install often to make sure it has not loosened.



Securing Child in Car Seat

To properly secure your child in the car seat, see pages 54-56.

Check your child's fit often and make any needed adjustments to the car seat as they grow.



1

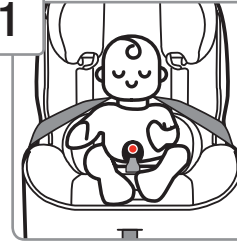

Place Child in Car Seat

Your child's bottom and back should be flat against the car seat.

Position the harness straps over your child's shoulders and upper thighs.

2

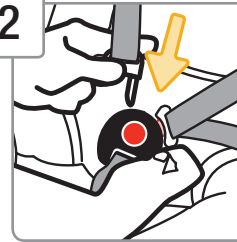

Buckle Harness

Push the buckle tongues into the buckle until you hear them "click".

Pull up on the harness straps to make sure the buckle is locked.

3

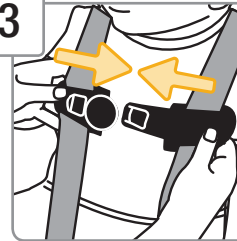

Fasten Chest Clip

Insert right half of the chest clip into the left half and snap together.

4

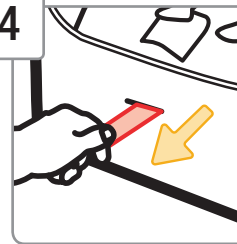

Tighten Harness

Pull the harness adjustment strap straight out to snugly tighten the harness system.

continued on next page



5

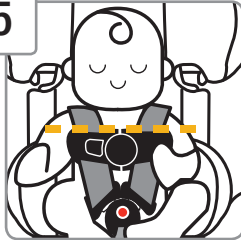

Position Chest Clip

Slide the chest clip up the harness straps and position it at mid-chest (even with armpits) and away from your child's neck.

6

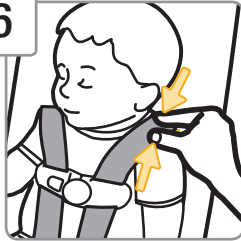

Check Harness Tightness

Try to pinch the harness strap at the shoulder vertically between your index finger and thumb as shown.

If your fingers slip off, the harness system is tight enough.

If you can pinch the harness strap, tighten more.

A snug strap should not allow any slack.

It lies in a relatively straight line without sagging.

It does not press on the child's flesh or push the child's body into an unnatural position.



Finished!

Your child is now secured in the car seat.

Check your child's fit often and make any needed adjustments to the car seat as they grow.

To Remove Child from Car Seat:

1. Loosen Harness Strap
2. Unbuckle Harness
3. Release Chest Clip
4. Remove Child



Failure to fasten and tighten the harness system correctly may allow the child to be ejected from the child restraint in a crash or sudden stop causing serious injury or death.



Do not mistake comfort for safety. The harness system must be snugly adjusted.

Do not put snowsuits or bulky garments on your child when placing them in the child restraint. Bulky clothing can prevent the harness straps from being tightened properly.



**40-80 lb (18.1-36.3 kg) and
43-52 in. (110.1-132.1 cm)**



Lap/Shoulder
Belt



Keep the booster
seat belted when
not in use.



Do not use the harness system when using as a booster seat.

Use only the vehicle's lap and shoulder belt system when restraining the child in this booster seat.



Do not use only the lap belt when using this seat as a booster seat. The shoulder belt must always be adjusted snugly across the child's chest. **NEVER** place shoulder belt under the child's arms or behind their back.

Do not use this booster seat if the tops of your child's ears are above the top of the booster seat's headrest.

Do not use LATCH when using as a booster seat. Secure the lower anchor belt and the tether strap to their storage attachments.

You must remove the harness system and the accessories in order to remove the seat pad for cleaning or when using the **Booster Seat Mode**.

To remove accessories, see page 3.

1

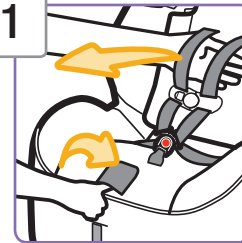

Fully Loosen Harness Straps

2

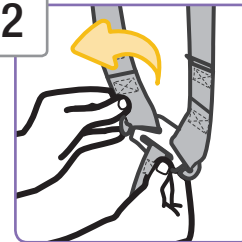

From Back of Car Seat,
Remove Harness Strap
Loops from Splitter Plate

3

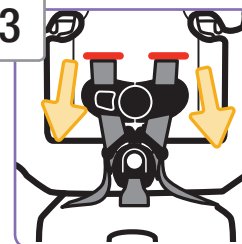

Pull Harness Straps Out of
Shoulder Harness Slots

continued on next page

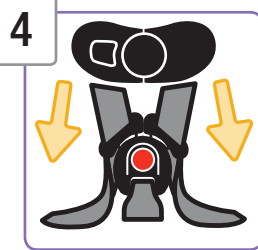

4 Unthread Chest Clip from
Harness Straps

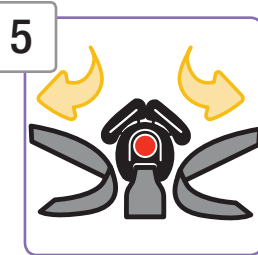

5 Unthread Buckle from
Harness Straps
Do not undo the buckle.

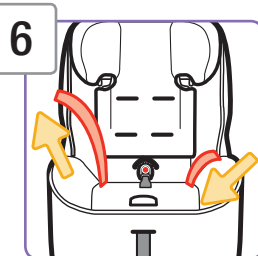

6 Pull Harness Strap Out of
Car Seat

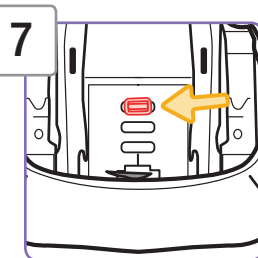

7 Turn Car Seat Over
Locate the buckle's metal retainer
on the bottom of the shell.

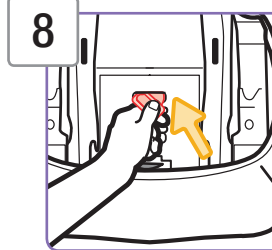

8 Rotate Metal Retainer and
Push It Up Through Buckle
Slot in Shell



9 From Top of Car Seat, Pull
Buckle Out of Shell and Pad

For Booster Seat Use

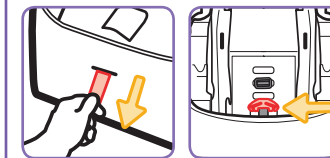

Store the harness strap, chest
clip, and buckle for future use.

Pull the harness adjustment
strap so the splitter plate is flush
against the shell as shown.

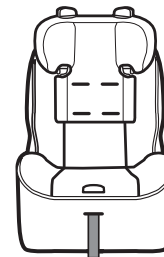

Finished!

The car seat has been converted to
the **Booster Seat Mode**.

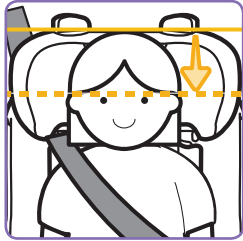

Head Position

The tops of your child's ears should never be above the top of the booster seat's headrest.



Shoulder Belt Position

The shoulder belt should lay snugly across the center of your child's shoulder and across their chest; **not on their face or neck.**

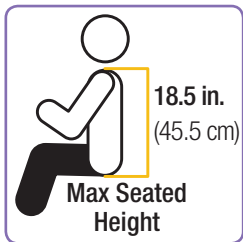

Max Seated Height

In this booster seat, the maximum seated height is **18.5 in.** (45.5 cm). **To measure your child's seated height:** have them sit on the floor with their back flat against a wall. Then measure from the floor up to the top of their shoulder.

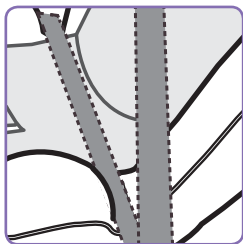

Lap Belt Position

The lap belt should lay snugly across your child's hips; **not on their stomach.**



You must remove the harness system when using the **Booster Seat Mode**, see pages 58-60.

1

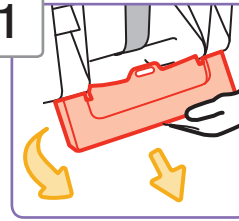

Place Car Seat into Position 2

Rotate the recline stand out and push it up to lock it into place.

2

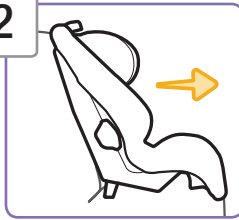

Make Booster Seat Flush Against Vehicle Seat

The vehicle seat back must be upright.

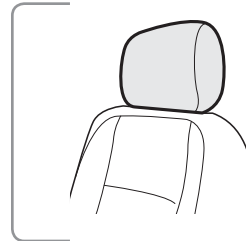

If your vehicle seat's headrest interferes with a flush booster seat fit, check your vehicle owner's manual to see if the headrest can be removed, adjusted, or if there are other possible seating locations to use the booster seat.

3

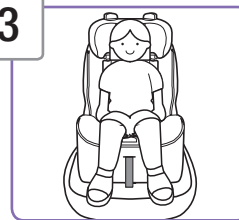

Have Child Sit in Booster Seat

continued on next page



4

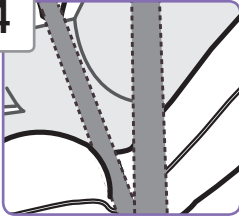

Position Lap Belt on Child

The lap belt should lay snugly across your child's hips; **not on their stomach.**

5

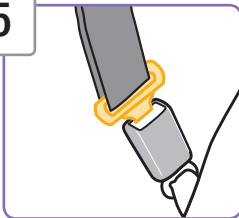

Buckle Vehicle Belt

Pull up on the lap belt to tighten.

6



Position Shoulder Belt on Child

Pull up on shoulder belt to tighten.

The shoulder belt should lay snugly across the center of your child's shoulder and across their chest; **not on their face or neck.**

Only use the shoulder belt-positioning guide in the headrest **if necessary** to help position the shoulder belt correctly on your child.



Finished!

Check periodically to make sure your child has not moved out of position and loosened the shoulder belt.

You must remove the harness system in order to remove the seat pad from the shell. See pages 58-60.

1

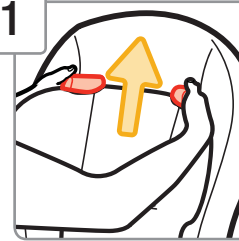

Adjust Headrest to Highest Position

2

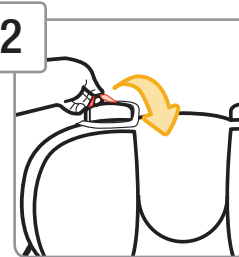

Pull Elastic Straps on Headrest Pad Over Headrest/Harness Adjustment Levers

3

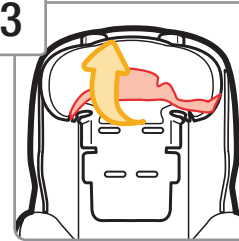

Pull Headrest Pad Off Bottom of Headrest

Remove the headrest pad from the shell.

continued on next page

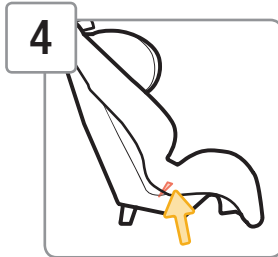

4 Release Elastic Straps from Tabs on Both Sides of Shell As Shown



5 Remove Seat Pad
Gently pull the seat pad off the top of the car seat and remove it from the shell.

Cleaning Pad and Accessories

Machine wash separately with cold water on a gentle cycle. Do not use bleach. Tumble dry separately for 10-12 minutes on low heat. Remove immediately.

Cleaning Harness Strap

Check the harness straps often for any wear or damage.

Spot clean using warm sudsy water and damp cloth.

Spilled food and liquids on the car seat may result in mold or bacterial growth over time. These spills could also attract insects or rodents.

⚠ Do not use the child restraint without the seat pad or with damaged harness straps.

Installing Seat Pad

Adjust the headrest to the highest position. Starting from the bottom, gently pull the headrest pad onto the headrest. Place the elastic straps on the headrest pad around the headrest/harness adjustment levers.

Starting from the bottom of the car seat, slip the pad on the shell. Pull the harness adjustment strap through the pad. Wrap the pad around the top of the shell. Attach the elastic straps.

Install the harness system, see pages 67-69.



Installing Buckle

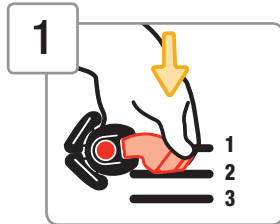

1 Insert Buckle's Metal Retainer into Buckle Slot Closest to Child

The buckle **must** face out.

Rear-Facing Mode: You **must** use the 1st or 2nd buckle slot.

Forward-Facing Mode: Any slot can be used.

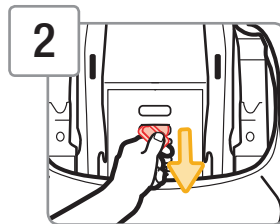

2 Pull Metal Retainer Completely Through Pad and Shell



3 Check Buckle

Pull up on the buckle to make sure it is secured.

The buckle **must not** pull out.

Installing Harness Straps



1 Thread Harness Strap into Hip Harness Slot

With the sewn end of the harness strap loop facing the buckle, thread the harness strap down through the hip harness slot as shown.

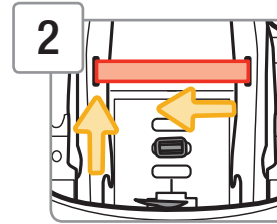

2 Turn Car Seat Over and Pull Harness Strap Across Bottom of Shell

Push the harness strap up through the other hip harness slot.

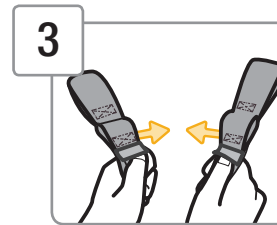

3 Make Harness Strap Even

The sewn end of the harness strap loops **must** face each other.

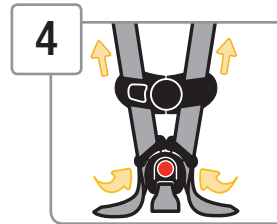

4 Thread Buckle and Chest Clip

The harness strap ends go through the **back** of the buckle tongues and through the chest clip **front to back** as shown.

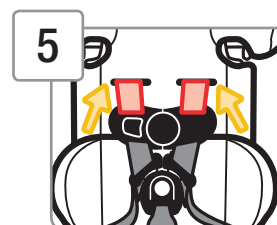

5 Thread Harness Straps into Shoulder Harness Slot

continued on next page

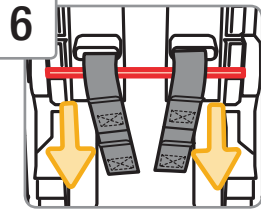

6

From Back of Car Seat, Thread Harness Straps Over Metal Bar

Do not twist the harness straps.

The harness adjustment strap and the splitter plate **must be** behind the harness strap as shown.

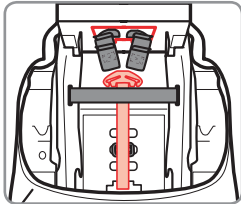

The harness strap loop ends **must** go through the recline stand as shown.

7

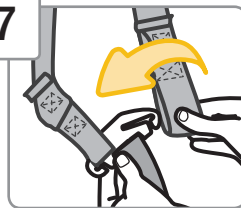

Attach 1st Harness Strap Loops to Splitter Plate As Shown

The sewn ends of the harness strap loops **must** face towards you.

Do not twist the harness strap or the harness adjustment strap.

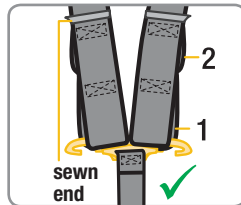

Make sure the harness strap loops are fitted **completely on** both sides of the splitter plate.

Check your child's fit often.

To learn how to check harness tightness, see pages 54-56.

If you cannot achieve a snug harness fit for your child, see pages 12-15.

Check the harness straps often for any wear or damage.

⚠️ The harness system must be installed correctly. Do not use a child restraint with damaged harness straps.



This restraint is certified for aircraft use when used with the internal harness.

This restraint is not certified for aircraft use when used as a booster seat because aircraft seats do not have shoulder belts.

Install the car seat in a window seat to avoid blocking the aisle. If the aircraft lap belt is too short, ask the flight attendant for a belt extender.

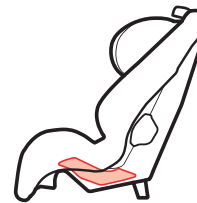

Use only on forward-facing aircraft seats. Contact the airline for their specific policies.

Some airlines may ask to see a label stating that this car seat is certified for aircraft use.

There is an airplane certification label located on the side of this car seat as shown.

⚠️ Store the lower anchor belt and tether strap when installing with aircraft belts.



Rear-Facing Aircraft Installation

Follow the steps on pages 26-32.



Forward-Facing Aircraft Installation

Follow the steps on pages 41-46, skipping the tether strap steps.

Replacement and Expiration of Car Seat

Do not risk your child's safety.

To keep your child as safe as possible, Dorel Juvenile Group strongly recommends replacing the car seat even after a minor crash; even if it was not occupied at the time.

Replacement After a Minor Crash

The National Highway Traffic Safety Administration states that for a crash to be considered minor **ALL of the following must be true:**

- Vehicle able to drive away from the crash site; **AND**
- Vehicle door nearest the car seat was not damaged; **AND**
- No passengers were injured; **AND**
- Airbags did not deploy; **AND**
- There is no visible damage to the car seat.

If the crash your car seat was involved in meets **ALL** the criteria, you may not need to replace the car seat.

If one or more of these criteria are not true or if you are uncertain of any of your answers, replace the car seat immediately.

Replacement After a Moderate to Severe Crash

You **must** replace this car seat if it has been in a moderate to severe car crash.

This car seat is intended to protect a child in a single crash. During a crash, the car seat and all of its parts absorb crash energy which can deform or weaken it. Damage is not always visible. A damaged car seat must be replaced immediately.



Expiration

On the side of the car seat there is a date of manufacture label as shown.

Do not use this car seat more than 10 years after the date of manufacture.



Child Restraint Use

Never take your child out of the child restraint while the vehicle is moving.

Never leave your child unattended. Placing your child in a hot child restraint may result in burns.

Do not use a child restraint with damaged or missing parts.

Do not use a child restraint with cut, frayed or damaged harnesses.

Do not substitute parts or try to modify the child restraint in any way. Do not lubricate buckles and fasteners.

Do not use any child restraint accessory except those approved by Dorel Juvenile Group.

Never allow any child to play with this child restraint; it is not a toy.

Do not remove or cover up any of the warning labels or other labels on the child restraint.

This child restraint has been certified for use in passenger vehicles. Do not use in a boat, on a motorcycle or in a cargo van or bus where there are no seat belts or tether anchors.

Read all instructions for additional warnings.

Installation in Vehicle

Check the vehicle belt or lower anchor belt before each use. Use only if the belt can be tightened properly and locked securely in place.

This child restraint should be securely belted in the vehicle even when not in use. In a crash or sudden stop, an unsecured child restraint could injure occupants.



Vehicle Seating Position



Never place a child rear-facing in a seating position with an active frontal air bag.



Check the vehicle owner's manual for more information about air bag/child restraint use.



Use the child restraint only on vehicle seats that face forward.

Do not use on seats that face the sides or rear of the vehicle.

For vehicles without a back seat, refer to your vehicle owner's manual.



Children are safer when properly restrained in rear seating positions than in the front seating positions.

According to accident statistics, children in rear seating positions are statistically safer, whether you have air bags, advanced air bags, or no air bags at all.

If you are not sure where to place the car seat in your vehicle: consult your vehicle owner's manual, contact Dorel Juvenile Group Consumer Care Department or visit your local Child Passenger Inspection Station.

Go to <http://www.safercar.gov/cpsApp/cps/index.htm> to find your closest station.

To avoid your child being seriously burned, take the following precautions:

- Park in the shade or where sun does not directly hit the car seat.
- Cover the car seat with a sheet or blanket when not in use.
- Check for hot seat and buckles before placing child in car seat.

To help protect your vehicle seat's upholstery from damage, use a single layer towel underneath and behind car seat.



Please complete the postage-paid registration card that came with your child restraint, and send it to us. Child restraints could be recalled for safety reasons. You must register this restraint to be reached in a recall. Send your name, address, e-mail address if available and the restraint's model number and manufacturing date to:

**Dorel Juvenile Group, Inc.
Consumer Care Department**

PO Box 2609, Columbus, IN 47202-2609

or call 1-800-544-1108 or register online at
www.djgusa.com/registration/carseat/us.

For recall information, call the U.S. Government's Vehicle Safety Hotline at 1-888-327-4236 (TTY: 1-800-424-9153), or go to www.NHTSA.gov.

Tear Off and Mail This Part or Register Online. Détachez et postez cette partie ou enregistrez en ligne. 4359-4117E

Consumer: Just fill in your name, address and email. Please print.
Client: Simplement inscrire votre nom, adresse et courriel. S.V.P. imprimez.

Your Name/Votre nom: _____

Your Street Address/Votre adresse: _____

City/Ville: _____ Province: _____ Postal Code/Code Postal: _____

Email Address (optional)/Courriel (optionnel): _____

AB123CDE COSCO CARSEAT 2015/05/16

Date of Purchase/Date d'achat: _____ L#11 B265035

Example of model number, line code, and manufacture date.



If you don't have the card or if your address changes, you will find the model number, manufacture date, and line code on the label located on side of shell.

Dorel Juvenile Group, Inc. (DJG) warrants this product to the original retail purchaser as follows: This product is warranted against defective materials or workmanship for one year from the date of original purchase.

An original receipt is required to validate your warranty.

DJG will, at its option, provide replacement parts or replace this product. DJG reserves the right to substitute if the part or model has been discontinued.

To make a claim under this warranty, please contact our Consumer Care Department by phone: 1-800-544-1108 or text: 1-812-652-2525. Our hours of operation are from 8:00 a.m. to 6:00 p.m. EST Monday through Thursday and from 8:00 a.m. to 4:30 p.m. on Friday.

Proof of purchase is required and shipping charges are the responsibility of the consumer.

Warranty Limitations: This warranty does not include damages which arise from misuse or abuse of this product.

Limitation of Damages: The warranty and remedies as set forth are exclusive and in lieu of all others, oral or written, expressed or implied. In no event will DJG or the dealer selling this product be liable to you for any damages, including incidental or consequential damages, arising out of the use or inability to use this product.

Limitation of warranties and other warranty terms and state law rights: Any implied warranties, including implied warranties of the merchantability and fitness for a particular purpose, shall be limited to the duration and terms of the express written warranty.

Some states do not allow limitations as to how long an implied warranty lasts or the exclusion or limitation of incidental or consequential damages, so the above limitations may not apply to you.

This warranty gives you specific legal rights, and you may have other rights, which vary from state to state. Neither DJG nor the dealer selling this product authorized any person to create for it any other warranty, obligation, or liability in connection with this product.

1. If the car seat's buckle or harness release lever sticks or you cannot get the straps tight enough around your child:

Do not lubricate. Check around the lever and the retractor for dropped food, sticky spilled drinks, dirt, leaves, etc. Clean with warm water and/or remove the object with tweezers. If you cannot get the harness to adjust and remain tight with the buckle securely locked, **do not** use this car seat.

2. If your harness twists:

Straighten the harness each time you put your child in the car seat to help prevent twisting. Lock the buckle and tighten the harness so it will be ready for next use.

If requested color is not available, similar color will be substituted. Prices are subject to change. Applicable tax and shipping & handling will also be added.

Part	Cost
Buckle Assembly.....	\$7.99
Harness Strap	\$2.99
Seat Pad Set.....	\$50.00
Chest Clip.....	\$1.50
Tether	\$6.00
Lower Anchor Belt.....	\$17.99
Instructions.....	\$0.00
Locking Clip.....	\$2.50

For parts availability and questions,
please call: 1-800-544-1108 or text: 1-812-652-2525.

If you already know which parts you need,
you may complete your order with a credit card
by calling us at 1-800-544-1108.

We accept Visa or MasterCard.

Hours of Operation:

M-TH: 8:00 AM - 6:00 PM EST

FRI: 8:00 AM - 4:30 PM EST

Thank you for choosing this car seat, also known as a child restraint. The DJG family is committed to creating car seats with the most comfort and convenience available today.

Remember, parents are a child's first teachers and examples. If you always buckle your seat belt, your child will think it is the natural thing to do. Make it a firm rule that the vehicle does not go until everyone is buckled up. Make no exceptions.

No one can predict if use of a car seat will prevent injury or death in a particular crash. However, when combined with careful driving, proper use of a car seat can lower a child's risk of injury or death in most crashes.

If you have questions or any concerns with this car seat, please contact our Consumer Care Department:

Call: 1-800-544-1108

Text: 1-812-652-2525

Website: www.coscokids.com

Hours of Operation:

M-TH: 8:00 AM - 6:00 PM EST

FRI: 8:00 AM - 4:30 PM EST