

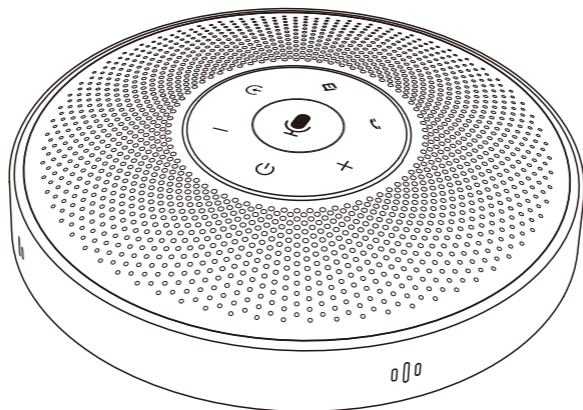

User Manual

OfficeCore M2
OfficeCore M220 Lite









Wireless Speakerphone

無線ハンズフリー電話 | 智能会议宝

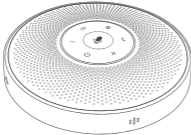





Drahtlose Freisprecheinrichtung | Telefono vivavoce wireless

Altavoz inalámbrico | Téléphone mains libres sans fil

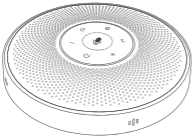
M2

			
× 1		× 1	
			
× 1	× 1	× 1	× 1

M220

					
× 2		× 2		× 1	
					
× 2	× 2	× 2	× 1		

CONTENTS

English.....	1
日本語.....	8
简体中文.....	15
Deutsch.....	22
Italiano	29
Español.....	36
Français.....	43

Buttons

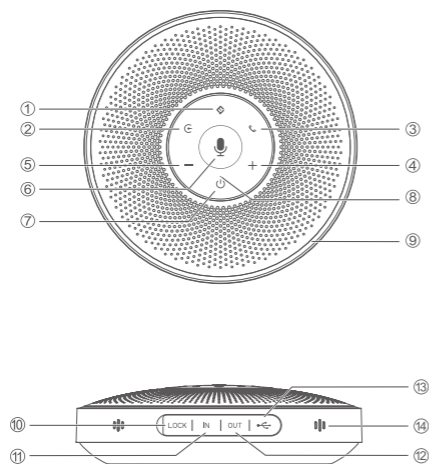



- ① AI noise reduction On/Off
- ② Bluetooth button
- ③ Answer/End Call
- ④ Volume up
- ⑤ Volume down
- ⑥ Mic Mute/Unmute
- ⑦ Power On/Off
- ⑧ LED Status Indicator
- ⑨ LED Ring-shaped

- ⑩ Lock port
- ⑪ AUX audio input port
- ⑫ Audio output/Daisy chain port
- ⑬ USB port
- ⑭ Microphone







Button Controls

Button	Action	Status
⏻	Press and hold	Power on/off
	Press	Battery level
+	Press	Volume up
-	Press	Volume down
⌂	Press and hold 2 seconds	Enter Bluetooth pairing mode
⬢	Press	AI noise reduction on/off
☎	Incoming call, press	Answer a call
	Incoming call, press and hold for 2 seconds	Reject a call
	Call going, short/long press	End a call
🎤	Press	Mute/Unmute microphone

LED Status Indicator

WHAT	Status	Light	
USB	USB connection (Power On)	Steady green	●
	Charging in power-off state	Flashes Yellow-green	
	Fully charged in power-off state	Steady Yellow-green	●
Bluetooth	Bluetooth pairing	Flashes blue	
	Bluetooth connected	Steady blue	●
AUX IN	Audio in connection	Steady white	●
Daisy chain	Daisy chain connection	Steady cyan	●

LED Ring-shaped

Status	Light	
Battery level	Turns green	
Battery low display	Flashes red	
Mic Mute	Turns red	
Volume level	Turns blue	
Incoming call when Bluetooth is connected	Flashes blue	
Skype for business incoming call when USB is connected		
Skype for Business Hold Mode	Turns cyan	

How to use

1. Power On/off

Press and hold the power button “  ” for 2 seconds to power on or off.

2. Connection

a) After connect the device to a PC via USB, start to use it.

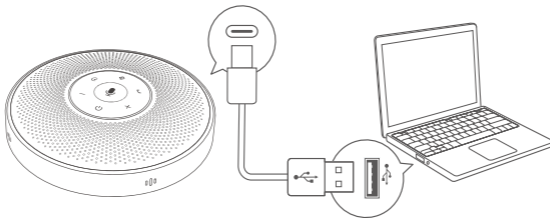

b) After connect it to the PC through eMeet Audio Adapter A200, start to use it.

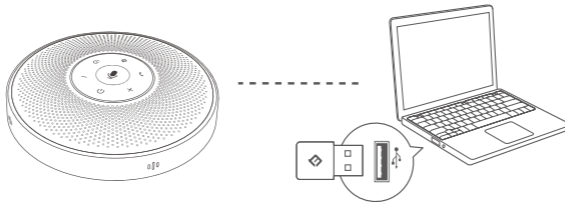

c) After connect mobile devices such as PCs or mobile phones through Bluetooth pairing, start to use it.

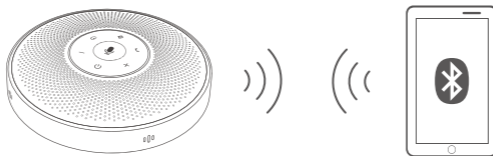

Note:

When turning on the device, it will connect to the last computer/mobile phone via Bluetooth whilst it is active.

·The names of Bluetooth in different products models are different:

	Prouct name	Bluetooth name
①	eMeet OfficeCore M2	eMeet M2
②	eMeet OfficeCore M220 Lite	eMeet M220 Lite

3. AI Noise Reduction

Short press “  ” AI Noise Reduction button to enable/disable AI noise function.

Turning on VoiceIA noise reduction can greatly reduce some noises in the meeting scene, such as from keyboard tapping, air conditioning noise, and general unwanted background noise

Note: After the noise reduction mode is enabled, in order to maintain good sound pickup effect, please make a call within a sound pickup range of 1.5 meters.



4. Charge

a) Via the computer

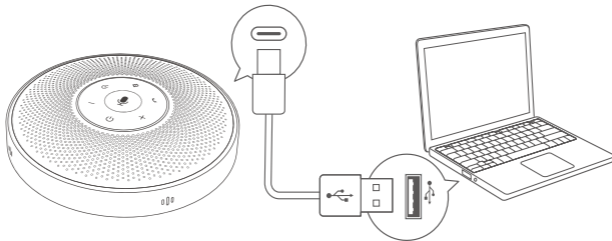

b) Through the adapter

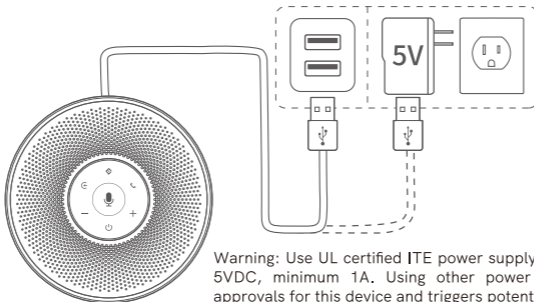

Warning: Use UL certified ITE power supply only, the rated output is 5VDC, minimum 1A. Using other power sources invalidates the approvals for this device and triggers potential danger.

5. Check Battery level

Short press “  ” to check Battery level.

When the device reaches 5% battery level, the ring-shaped light will glow red, and a low battery prompt will be generated.

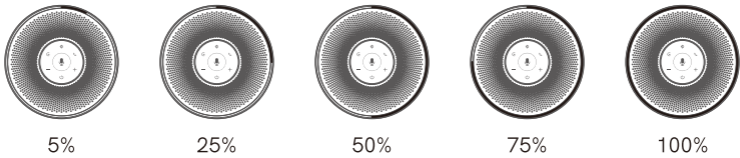

6. Audio Output

Use the AUX cable to connect the external speaker to the AUX OUT port of this device, and the audio will be played synchronously with this device through the external speaker.

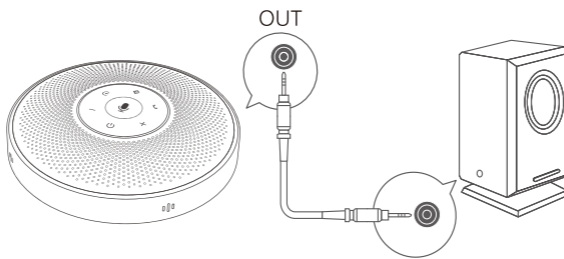

7. Daisy chain function

The Daisy chain function requires the use of Daisy chain cable, which are inserted into the OUT port (Red terminal) of the two machines using Daisy chain cable to extend the distance of sound pickup and playback so as to get a larger meeting space.



Note: Daisy-Chain cable is not provided with M2 product.

8. Audio Input

Use the AUX cable to connect the phone to the AUX IN ports of this device. This device will replace the speaker and microphone of the phone.

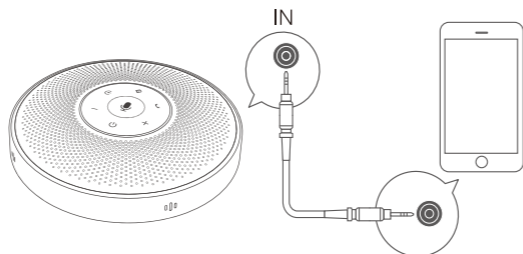

9. LOCK port Setting

Lock the product through the LOCK port to prevent theft.

Note: The LOCK port is of a Kensington computer type which requires the user to buy a lock otherwise.

Product information

Rated power	3W RMS
Frequency response	20Hz~20KHz(± 3 dB)
SNR	> 80 dB
Bluetooth version	V4.2
Bluetooth distance	20m
Microphone sensitivity	-26dBFS
Microphone frequency response	100Hz~8KHz(± 3 dB)
Microphone directivity	360 degree omnidirectional
Charge specification	5V/1A
Size	125x125x35mm(± 5 mm)

Note: In case of any change in specifications, official website information shall prevail.

FAQ

Problem or phenomenon	Possible Causes	Method
Startup failure	Low or no battery	Access the adapter to charge
Automatic shutdown soon after starting up	Low battery	Access the adapter to charge
No sound	turn off the volume	Adjust the device volume
USB failure	Error with using USB cable	Please use the original USB cable
AUX failure	Error with using AUX cable	Please use the original AUX cable
Daisy chain failure	Plug in the AUX audio input port; Error with using Daisy chain cable	Please plug the original Daisy chain cable into the audio output port/Daisy chain port
Device charge failure	Faulty charging device or full battery	Replace with a functional device

Customer Service



support@emeet.ai



www.emeet.ai



US: + 1 8889595320(EST 9:00am-5:00pm Mon-Fri)

日本語

ボタン一覧

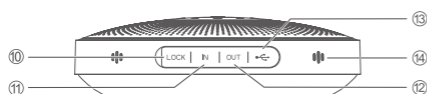
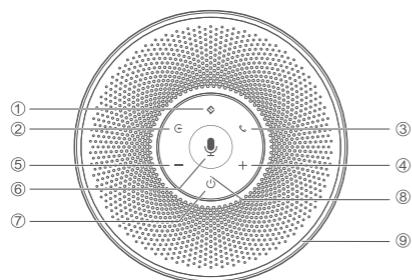

- ① AIノイズリダクションのオン/オフ
- ② Bluetoothキー
- ③ 電話応答\ハングアップキー
- ④ ボリュームアップキー
- ⑤ ボリュームダウンキー
- ⑥ マイクのミュート及び解除
- ⑦ 電源キー
- ⑧ ステータスインジケータ
- ⑨ リングライト

- ⑩ 鍵穴
- ⑪ AUXオーディオ入力端子
- ⑫ イヤホンオーディオ出力端子/
ディジーチェーン端子
- ⑬ USBポート
- ⑭ マイク

ボタン制御

ボタン	行動	状況
⏻	長押し	電源オン/電源オフ
	短押し	バッテリー表示
+	短押し	ボリュームアップ
-	短押し	ボリュームダウン
G	長押し	ブルートゥースペアリングに進む
◆	短押し	AIノイズリダクションのオン/オフ
☎	着信状態、短押し	通話開始
	着信状態、2秒間長押し	着信を拒否する
	通話状態、短/長押し	通話終了
🎤	短押し	マイクのミュート/ミュート解除

ステータスインジケータ

	ステータス	ランプ	
USB	USB接続	緑点灯	●
	電源オフ状態で充電中	黄緑ブリージングライト点灯	
	電源オフ状態で充電完了	緑黄常時点灯	●
Bluetooth	ブルートゥースペアリング中	青点滅	
	ブルートゥースに接続しました	青常時点灯	●
AUX IN	AUX IN入力	白点灯	●
カスケード	カスケード	アイスブルー点灯	●

リングライト

ステータス	ランプ	○
バッテリー表示	緑点灯	○
ローバッテリー表示	赤点滅	
マイクミュート	赤点灯	○
ボリューム表示	青点灯	○
ブルートゥース着信	青点滅	
USB 接続時にSkype for business着信		
Skype for Business Hold表示	アイスブルー点灯	○

取扱説明

1. オン\オフにする

電源キー「」を2秒間押し続けると、オンまたはオフにします。

2. 接続

a) USBケーブルでコンピューターと接続し、起動して使用します。

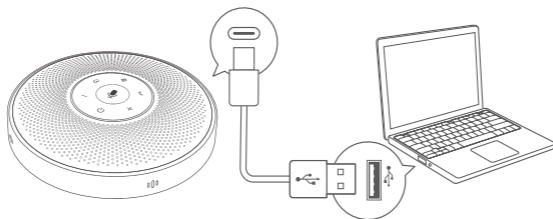

b) eMeet Audio Adapter A200を使用してコンピューターと接続し、起動して使用します。

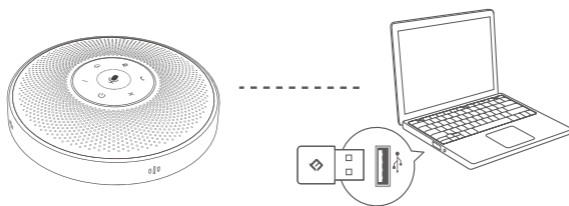

c) 起動後、ブルートゥースペアリングを通じてコンピューターや携帯電話などのモバイルデバイスに接続します。

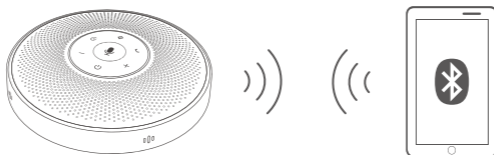

備考:

起動するたびに、本製品は前回ブルートゥースで接続したデバイスに自動的に接続します（デバイスのブルートゥースをオンにしてください）。

・型番によってブルートゥースの名称が違います:

	製品番号	Bluetooth名
①	eMeet OfficeCore M2	eMeet M2
②	eMeet OfficeCore M220 Lite	eMeet M220 Lite

3. AIノイズリダクション

「」AIノイズリダクションキーを短押しすると、AIノイズリダクションをオンまたはオフにできます。

VoicelAノイズリダクションをオンにすると、タイピング音、エアコンのノイズ、テーブルや椅子の移動音等、会議中に発生するノイズを除去できます。

注意：ノイズリダクションモードをオンにしたら、良好な集音効果を維持するため、1.5メートルの集音範囲内で通話してください。

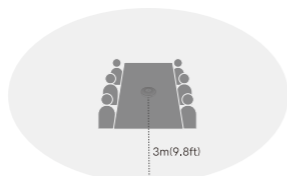

VoicelA® OFF

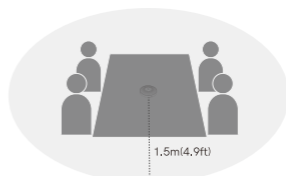

VoicelA® ON

4. 充電

a) コンピューターでの充電

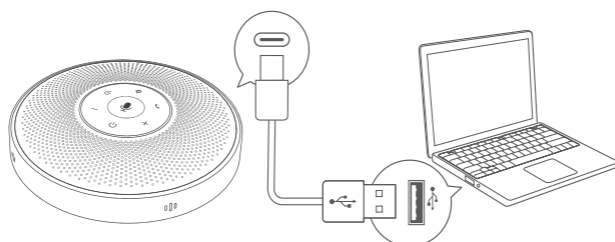

b) 電源アダプタでの充電

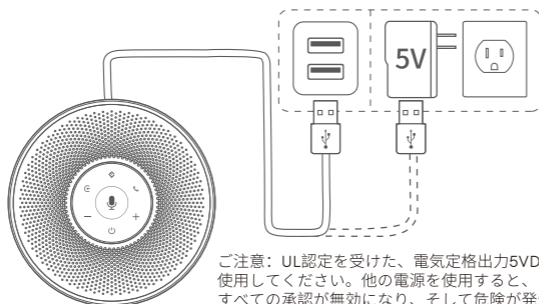

ご注意：UL認定を受けた、電気定格出力5VDC、最小1AのITE電源のみ使用してください。他の電源を使用すると、このデバイスで取得されたすべての承認が無効になり、そして危険が発生する場合があります。

5. 電池残量の確認

「」ボタンを短く押すと、電池残量を確認することができます。

機器の電池残量が5%以下になると、リング状の照明が赤くなり、電池残量低下の表示になります。

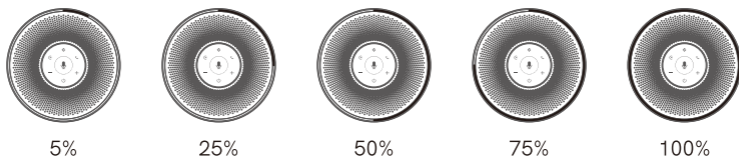

6. 音声出力

AUXケーブルを使って外部スピーカーをAUX OUTジャックに接続すると、オーディオは外部スピーカーと本機を通じて同時に放送します。

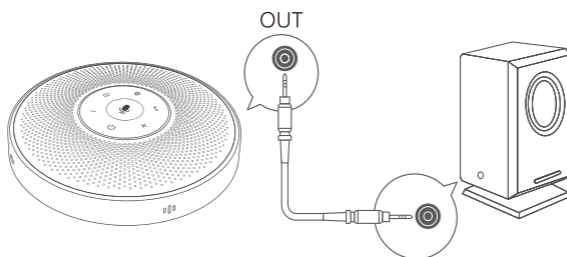

7. デイジーチェーン機能

デイジーチェーン機能では、カスケード回線を使用する必要があります。カスケード回線は、カスケード回線を使用して二台のマシンのOUT端子（赤い端子）に挿入し、ピックアップ&再生の距離を広げることができて、より大きい会議の空間を獲得します。

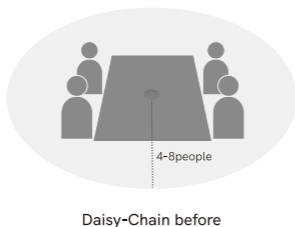

Daisy-Chain before

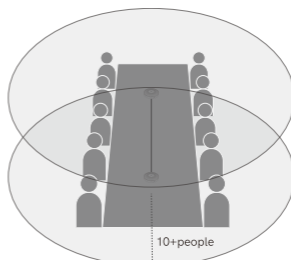

Daisy-Chain after

備考：M2カスケードケーブルは個別に購入する必要があります。

8. 音声入力

AUXケーブルを使用して、携帯電話をこの製品のAUX INジャックに接続した場合、この製品は、携帯電話のスピーカーとマイクに置き換わります。

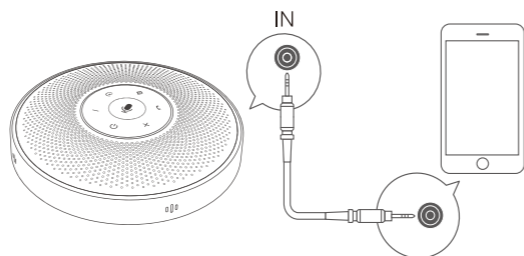

9. ロックの設定

ロックによって製品に施錠し、盗難を防ぎます。

注：このロックはKensingtonセキュリティスロットを使用しているため、別途固定金具や鍵を購入する必要があります。

製品の仕様

定格電力	3W RMS
周波数応答	20Hz~20KHz(±3dB)
信号対雑音比	>80dB
Bluetoothバージョン	V4.2
Bluetooth距離	20メートル
マイク感度	-26dBFS
マイク周波数応答	100Hz~8KHz(±3dB)
マイク指向性	360°全指向
充電仕様	5V/1A
サイズ	125x125x35mm(±5mm)

備考：仕様が変更された場合は、公式ウェブサイトの情報を参考してください。

共通の問題の解決

問題または現象	考えられる原因	解決方法
オンにすることができない	電池残量が少なすぎる ことまたは電池切り	アダプターに接続して充電
起動後すぐ自動的にシャットダウン	電池残量が少なすぎる	アダプターに接続して充電
無音	正しく接続されているかどうか; ボリュームがオンになっているかどうか	またはデバイスのボリュームを調整
USB通話ができない	USBケーブルの使用が正しいかどうか	元のUSBケーブルを使用してください
AUX通話ができない	AUXケーブルの使用が正しいかどうか	元のAUXUSBケーブルを使用してください
デジィチェーンができない	端子の使用が正しいかどうか; デジィチェーンケーブルの使用が正しいかどうか	ンオーディオ出力端子\デジィチェーン端子使用してください;元のデジィチェーンUSBケーブルを使用してください
デバイスは充電できない	充電装置が故障、または充電済	正常の充電装置を交換

お問い合わせ



support@emeet.ai



www.emeet.ai



日本: + 81 8008051955(JST 10:00am-6:00pm 月曜日～金曜日)

简体中文

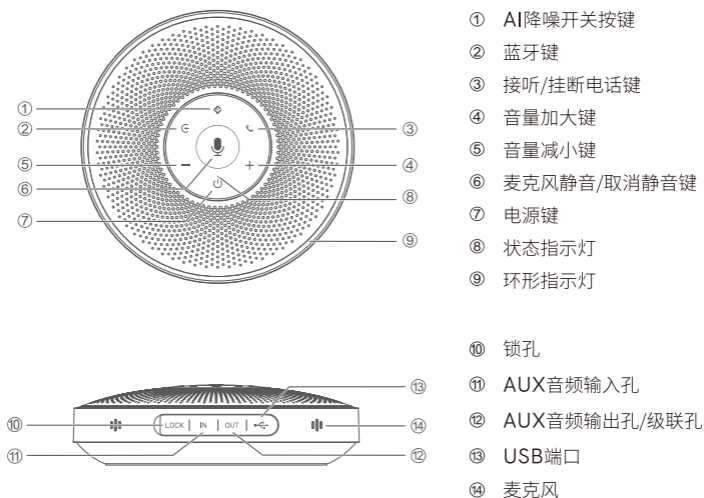

按键展示



按键控制

按键	动作	状态
⏻	长按	开机/关机
	短按	电量显示
+	短按	音量增加
-	短按	音量减小
Ⓞ	长按	进入蓝牙配对状态
🔒	短按	开启/关闭AI降噪
☎	来电状态, 短按	接听
	来电状态, 长按	拒接
	通话状态, 短/长按	挂断电话
🎤	短按	麦克风静音/解除麦克风静音

状态指示灯

项目	状态	灯光	
USB	USB连接（开机状态下）	亮绿色	●
	充电中（关机状态下）	亮黄绿色呼吸灯	
	充满电（关机状态下）	黄绿灯常亮	●
Bluetooth	蓝牙未连接	蓝色闪烁	
	蓝牙连接成功	亮蓝色	●
AUX IN	AUX IN输入	亮白色	●
级联	级联状态	亮冰蓝色	●

环形指示灯

状态	灯光	
电量显示	亮绿色	
低电量显示	红色闪烁	
麦克风静音	亮红色	
音量显示	亮蓝色	
蓝牙来电	蓝色闪烁	
USB连接时, Skype for Business来电		
Skype for Business Hold模式显示	冰蓝色常亮	

使用说明

1. 开关机

长按「」电源键2秒，开机或者关机。

2. 连接

a) 使用USB线连接电脑，开机使用。

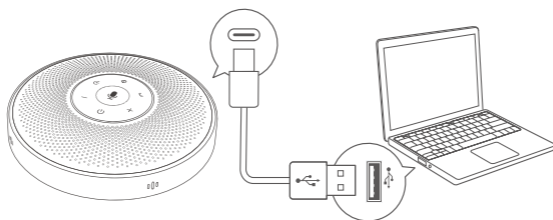

b) 使用eMeet Audio Adapter A200连接电脑，开机使用。

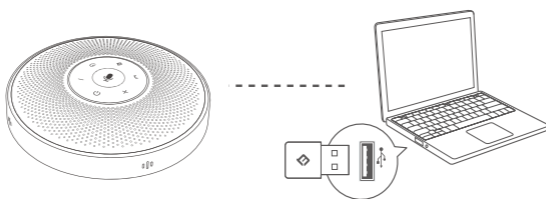

c) 开机后，通过蓝牙配对连接手机等移动设备。

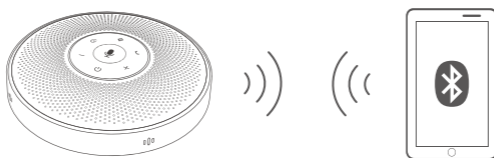

注意：每次开机时，本产品的蓝牙会自动回连上次成功连接的设备（设备需打开蓝牙）。

·不同型号的产品蓝牙名称不同：

	产品型号	蓝牙名称
①	eMeet OfficeCore M2	eMeet M2
②	eMeet OfficeCore M220 Lite	eMeet M220 Lite

3. AI降噪

短按「」AI降噪键，可以打开或关闭AI降噪。

打开AI降噪可以屏蔽会议场景出现的一些噪音，比如键盘敲击声，空调噪音以及推动桌椅声等。

注意：开启降噪模式后，为了保持良好的拾音效果，请在1.5米的拾音范围内进行通话。

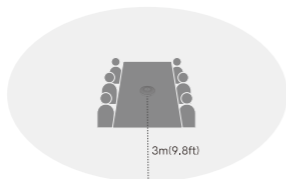

VoiceIA® OFF (关)

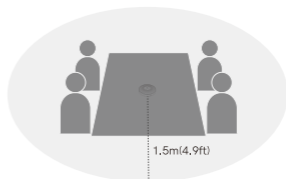

VoiceIA® ON (开)

4. 充电

a) 通过电脑充电

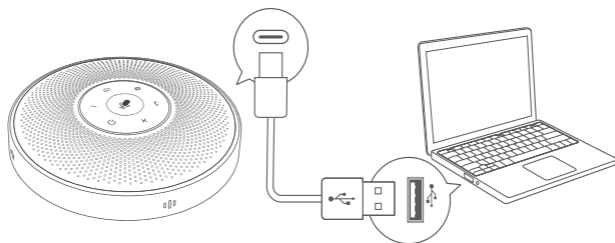

b) 通过电源适配器充电

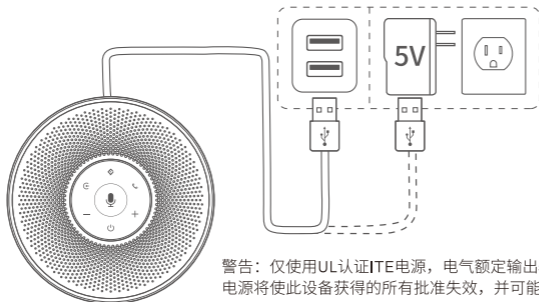

警告：仅使用UL认证ITE电源，电气额定输出5VDC，最小1A。使用其他电源将使此设备获得的所有批准失效，并可能产生危险。

5. 查看电量

短按「」可以查看电量。

当剩余电量为5%时，环形指示灯会亮起红色灯光。

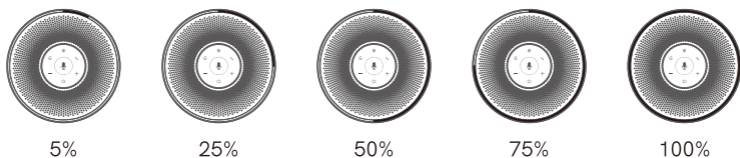

6. 音频输出

使用AUX线将外部扬声器连接到本产品的AUX OUT插孔，音频将通过外部扬声器和本机同步播放。

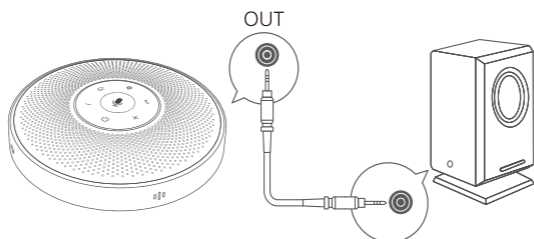

7. 级联功能

级联功能需要使用级联线，使用级联线插入两台机器的OUT孔（红色端子），扩展拾音&放音的距离，获得更大的会议空间。

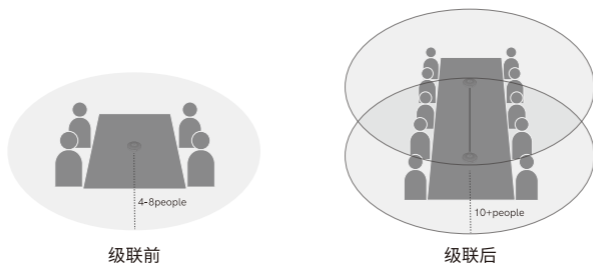

注意：M2不随附级联线。

8. 音频输入

使用AUX线将手机连接到本产品的AUX IN插孔，本产品将取代手机的扬声器和麦克风。

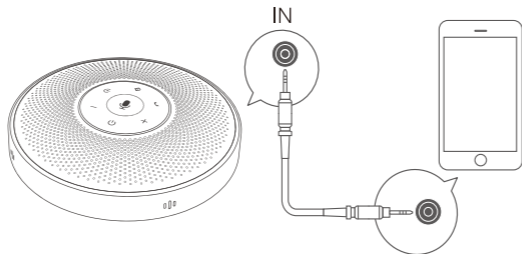

9. 锁孔设置

可利用LOCK锁孔将产品锁起来，防止被盗。

注意：本锁孔采用的Kensington电脑锁孔，锁需自行购买。

产品参数

额定功率	3W RMS
频率响应	20Hz~20KHz(± 3 dB)
信噪比	>80dB
Bluetooth蓝牙版本	V4.2
Bluetooth蓝牙距离	20米
麦克风灵敏度	-26dBFS
麦克风频率响应	100Hz~8KHz(± 3 dB)
麦克风指向性	360°全指向
充电规格	5V/1A
尺寸	125x125x35mm(± 5 mm)

注意：规格如有变更，请以官网信息为准

常见问题处理

问题或现象	可能原因	处理方法
开不了机	电量过低或者没有电量	接入适配器充电
开机很快自动关机	电量过低	接入适配器充电
没有声音	音量未打开	调节设备音量大小
USB无法通话	使用USB线有误	请使用原装USB线进行通话
AUX无法通话	使用AUX线有误	请使用原装AUX线进行通话
级联无法使用	错误地插入AUX音频输入孔(IN孔); 使用级联线有误	请插入音频输出孔(OUT孔)\级联孔; 请使用原装级联线
设备无法充电	充电设备故障或者电池已充满	更换功能正常的充电设备

联系我们



support@emeet.ai



www.emeet.ai



中国: 400 8338 051(北京时间上午9:00至下午5:00 周一至周五)

Tasten

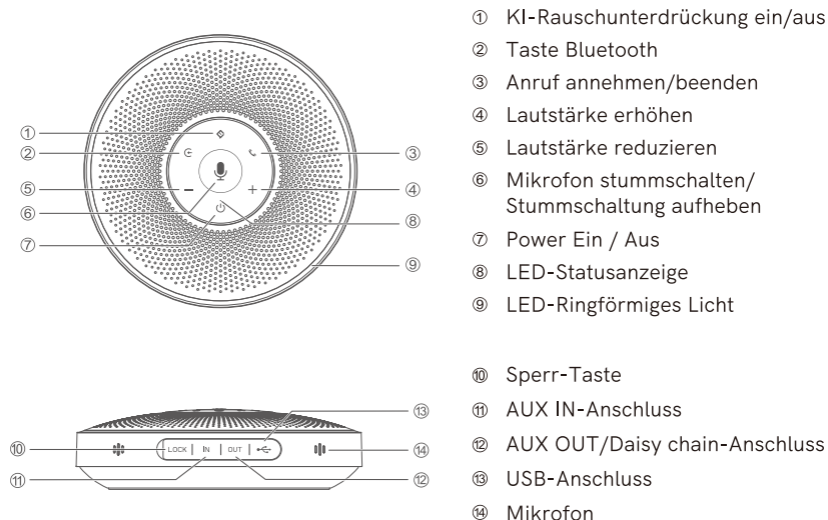



Übersicht über die Tastenbedienung

	Status	Anzeige
⏻	Gedrückt halten	Ein-/Ausschalten
	Drücken	Batteriestand
+	Drücken	Lautstärke auf
-	Drücken	Lautstärke ab
📶	2 Sekunden gedrückt halten	Bluetooth-Kopplungsmodus aufrufen
🔒	Drücken	KI-Rauschunterdrückung ein/aus
☎	Eingehender Anruf, drücken	Anruf annehmen
	Eingehender Anruf, 2 Sekunden lang gedrückt halten	Anruf ablehnen
	Anruf aktiv, kurz/lang drücken	Anruf beenden
🎤	Drücken	Stummschalten / Stummschaltung aufheben

LED-Statusanzeige

	Status	Licht	
USB	USB-Verbindung	Wechselt zu Grün	●
	Aufladen im ausgeschalteten Zustand	Gelb-grüne LED-Anzeige blinkt	
	Vollständig aufgeladen im ausgeschalteten Zustand	Gelb-grüne LED-Anzeige leuchtet dauerhaft	●
Bluetooth	Bluetooth-Kopplung	Blinkt blau	
	Bluetooth verbunden	Dauerhaft blau	●
Audio-in-Verbindung	Audio-in-Verbindung	Wechselt zu Weiß	●
Daisy-Chain	Daisy-Chain	Wechselt zu Cyan	●

LED-Ringförmiges Licht

Status	Licht	
Anzeige für Batterie	Wechselt zu grün	
Anzeige für schwache Batterie	Blinkt Rot	
Mikrofon stummschalten	Wechselt zu Rot	
Anzeige der Lautstärke	Wechselt zu blau	
Eingehender Anruf, wenn eine Bluetooth-Verbindung besteht.	Blinkt blau	
Eingehende Skype for Business-Anrufe, wenn USB angeschlossen ist.		
Skype for Business Hold	Wechselt zu Cyan	

Bedienungsanleitung

1. Das Ein- und Ausschalten

Drücken Sie die " ⏻ " für 2 Sekunden, um das Gerät ein- oder auszuschalten

2. Verbindung

a) Schließen Sie das Gerät über USB an einen PC an, dann ist es funktionsbereit.

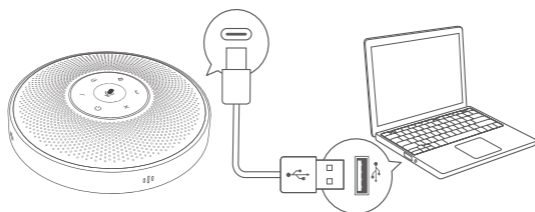

b) Schließen Sie das Gerät über den eMeet Audio Adapter A200 an den PC an, dann ist es funktionsbereit.

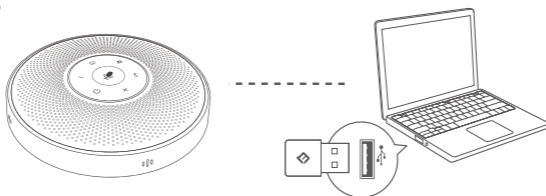

c) Nachdem Sie mobile Geräte wie PCs oder Mobiltelefone durch Bluetooth-Kopplung verbunden haben, ist das Gerät funktionsbereit.

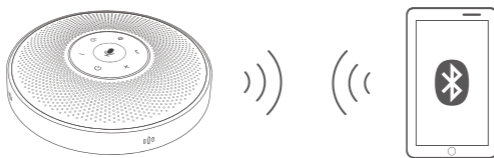

Hinweis:

Beim Einschalten des Geräts wird eine Verbindung mit dem letzten Computer/Mobiltelefon über Bluetooth hergestellt, solange das Gerät aktiv ist.

·Verschiedene Modelle haben unterschiedliche Bluetooth-Namen:

	Produktmodell	Bluetooth-Namen
①	eMeet OfficeCore M2	eMeet M2
②	eMeet OfficeCore M220 Lite	eMeet M220 Lite

3. KI-Rauschunterdrückung

Drücken Sie kurz die Taste KI-Rauschunterdrückung "  ", um die KI-Rauschunterdrückung zu aktivieren/deaktivieren.

Wenn die VoiceIA Rauschunterdrückung aktiviert ist, können einige Geräusche im Besprechungsraum, wie z.B. das Tippen auf der Tastatur, die Geräusche der Klimaanlage und allgemeine unerwünschte Hintergrundgeräusche, stark reduziert werden.

Hinweis: Nachdem der Rauschunterdrückungsmodus aktiviert wurde, sollten Anrufe für eine gute Tonaufnahme innerhalb eines Tonaufnahmebereichs von 1.5 Meter getätigt werden.

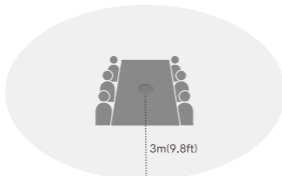

VoiceIA® OFF

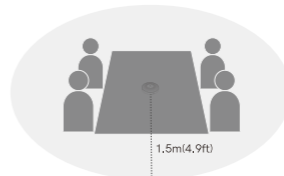

VoiceIA® ON

4. Aufladen

a) Aufladen per USB

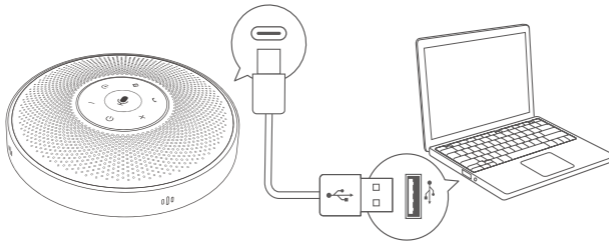

b) Aufladen per Netzadapter

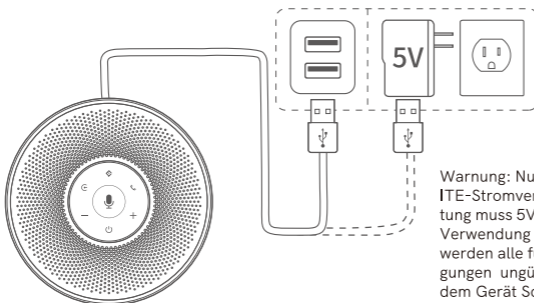

Warnung: Nutzen Sie bitte nur eine UL-zertifizierte ITE-Stromversorgung. Die elektrische Nennleistung muss 5VDC betragen, mit mindestens 1A. Bei Verwendung einer anderen Stromversorgung werden alle für dieses Gerät erhaltenen Genehmigungen ungültig, außerdem können dadurch an dem Gerät Schäden entstehen.

5. Batteriestand prüfen

Drücken Sie kurz "  ", um den Batteriestand zu prüfen.

Wenn das Gerät einen Batteriestand von 5% erreicht, wird das ringförmige Licht rot leuchten und eine Batteriewarnanzeige wird generiert.

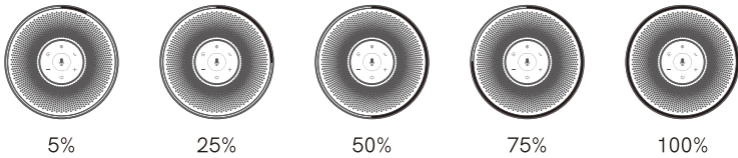

6. Audio-Ausgabe

Verwenden Sie das AUX-Kabel, um den externen Lautsprecher an den AUX OUT-Anschluss dieses Geräts anzuschließen. Dann wird der Ton synchron mit diesem Gerät über den externen Lautsprecher wiedergegeben.

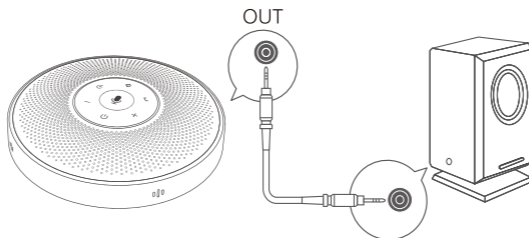

7. Daisy chain funktion

Für die Daisy-Chain-Funktion ist die Verwendung eines Daisy-Chain-Kabels erforderlich, das mithilfe eines Daisy-Chain-Kabels in den OUT-Anschluss (Rotes Terminal) der beiden Geräte eingesteckt wird, zur Erweiterung der Entfernung zwischen Empfang und Wiedergabe. Dadurch kann mehr Platz für Besprechungen erwerben.



Hinweis: Das Kaskade Kabel wird nicht mit diesem M2 Produkt geliefert.

8. Audio-Eingang

Verwenden Sie das AUX-Kabel, um das Telefon an die AUXIN-Anschlüsse dieses Geräts anzuschließen. Dieses Gerät ersetzt den Lautsprecher und das Mikrofon des Telefons.

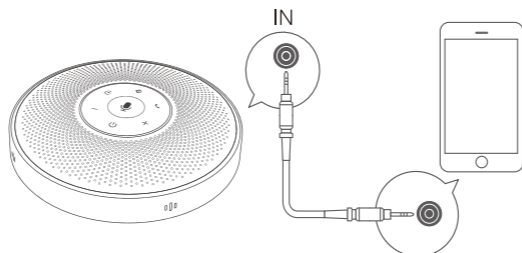

9. LOCK-Anschluss

Sichern Sie das Gerät an diesem Anschluss mit einem Schloss gegen Diebstahl.

Hinweis: Der LOCK-Anschluss benötigt ein Kensington-Schloss, das separat erworben werden muss.

Produktinformation

Nennleistung	3W RMS
Frequenzgang	20Hz~20KHz(±3dB)
Signal-Rausch-Verhältnis	>80dB
Bluetooth Version	V4.2
Funktionsumfang Bluetooth	20 Meter
Mikrofonempfindlichkeit	-26dBFS
Frequenzgang des Mikrofons	100Hz~8KHz(±3dB)
Richtungsfähigkeit des Mikrofons	360°
Ladungsspezifikation	5V/1A
Produktabmessungen	125x125x35mm(±5mm)

Hinweis: Im Falle einer Änderung der Spezifikationen haben die offiziellen Informationen der Website Vorrang.

Lösung der häufigen Probleme

Problem oder Phänomen	Mögliche Ursache	Lösung
Das Produkt kann nicht angeschaltet werden	Akku ist nicht geladen	Über USB bzw. Netzadapter aufladen
Die Maschine schaltet bald aus nach der Einschaltung	Akkuleistung zu gering	Über USB bzw. Netzadapter aufladen
Kein Ton	Achten Sie auf die korrekte Verbindung. Stummschalten Status	Betätigen Sie den Lautstärkeregler
USB Nutzung nicht möglich	Prüfen die das USB Kabel auf Mängel	Nutzen Sie nur das Original USB Kabel
AUX Nutzung nicht möglich.	Prüfen die das AUX Kabel auf Mängel	Nutzen Sie nur das Original AUX Kabel
Daisy chain Nutzung nicht möglich	Prüfen die das AUX-Audio-Buchse;Prüfen die das Daisy chain kabel auf Mängel	Nutzen Sie nur das Audio Buchse/Daisy chain Buchse; Nutzen Sie nur das Original Daisy chain kabel
Das Gerät kann nicht geladen werden	Gerätefehler oder Akku ist voll	Ersetzen Sie den Akku

Kundendienst



support@emeet.ai



www.emeet.ai



US: + 1 8889595320(EST 9:00am-5:00pm Mon-Fri)

Display pulsante

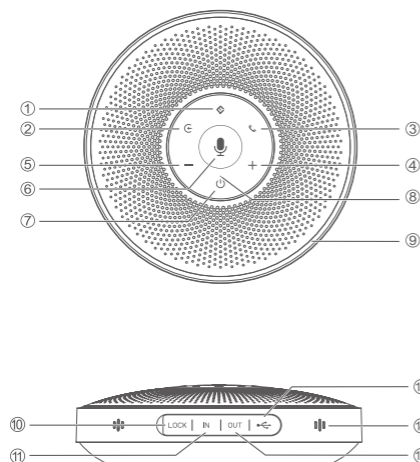

- ① Riduzione rumore AI on/off
- ② Pulsante Bluetooth
- ③ Pulsante rispondi/fine
- ④ Volume Su
- ⑤ Volume Giù
- ⑥ Attiva/Disattiva audio del microfono
- ⑦ Accensione /spegnimento
- ⑧ Spia di stato
- ⑨ Spia a forma di anello
- ⑩ Porta Blocca
- ⑪ Porta di ingresso audio AUX
- ⑫ Porta di uscita audio AUX/Daisy chain
- ⑬ Porta USB
- ⑭ Microfono

Controllo pulsante

Pulsante	Azione	Stato
⏻	Pressione lunga	Accensione/spegnimento
	Breve pressione	Display batteria
+	Breve pressione	Volume su
-	Breve pressione	Volume giù
Ⓜ	Pressione lunga per 2 secondi	Accedere alla modalità di associazione Bluetooth
⬠	Breve pressione	Riduzione rumore AI on/off
☎	Stato della chiamata, breve pressione	Rispondi
	Stato della chiamata, pressione lunga per 2 secondi	Rifiutare
	Chiamata in corso, pressione breve/pressione lunga	Riattacca
🎤	Breve pressione	Disattiva audio/Riattiva audio

Spia di stato

	Stato	Spia	
USB	Porta USB	Diventa verde	●
	Caricamento in stato off	Spia LED giallo-verde lampeggiante	
	Completamente carico in stato off	Spia LED giallo-verde sempre accesa	●
Bluetooth	Associazione Bluetooth	Lampeggia di colore blu	
	Bluetooth connesso	Blu fisso	●
INGRESSO AUX	Porta di INGRESSO AUX	Diventa bianco	●
Daisy chain	Daisy chain	Diventa ciano	●

Spia a forma di anello

Stato	Spia	
Display batteria	Diventa verde	
Display batteria scarica	Lampeggia di colore rosso	
Disattiva audio	Diventa rosso	
Display volume	Diventa Blu	
Chiamata in arrivo quando il Bluetooth è connesso	Lampeggia di colore Blu	
Skype per chiamate di lavoro in arrivo quando l'USB è connessa		
Skype for Business Hold	Diventa ciano	

Istruzioni di funzionamento

1. Accensione/Spegnimento

Premere e tenere premuto il pulsante di accensione "  " per 2 secondi per accendere o spegnere.

2. Connessione

a) Dopo aver connesso il dispositivo a un PC tramite USB, iniziare ad utilizzarlo.

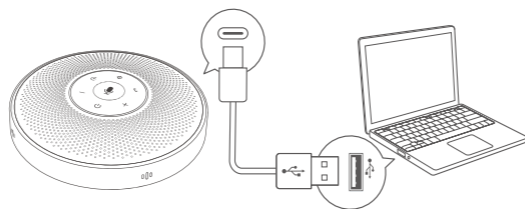

b) Dopo averlo collegato al PC tramite il eMeet Audio Adapter A200, iniziare a utilizzarlo.

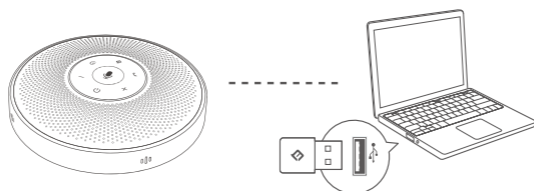

c) Dopo aver collegato dispositivi mobili come telefoni cellulari attraverso l'associazione Bluetooth, iniziare a utilizzarlo.

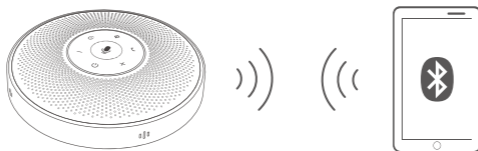

Nota:

In fase di accensione del dispositivo, quest'ultimo si conatterà all'ultimo computer/cellulare tramite Bluetooth mentre è attivo.

·I diversi tipi di prodotti con un diverso nome Bluetooth:

	Numero del prodotto	Nome Bluetooth
①	eMeet OfficeCore M2	eMeet M2
②	eMeet OfficeCore M220 Lite	eMeet M220 Lite

3. Riduzione del rumore IA voce

Premere brevemente " ◆ " la riduzione del rumore IA per attivare/disattivare la funzione rumore IA.

L'attivazione della riduzione rumore voce IA consente di ridurre in modo significativo alcuni rumori nella scena dell'incontro, ad esempio il rumore dei tasti premuti sulla tastiera, il rumore dell'aria condizionata, e in generale rumori di fondo indesiderati.

Nota: Dopo aver attivato la modalità di riduzione del rumore, al fine di mantenere un ottimo effetto di captazione del suono, si prega di fare una chiamata entro un range di captazione dei suoni di 1.5 metro.

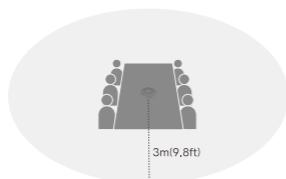

VoiceIA® OFF

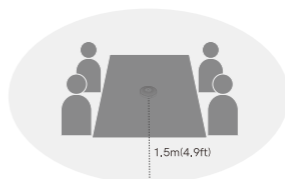

VoiceIA® ON

4. Caricamento

a) Tramite il computer

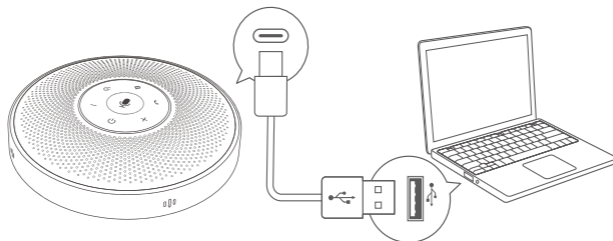

b) Tramite l'adattatore

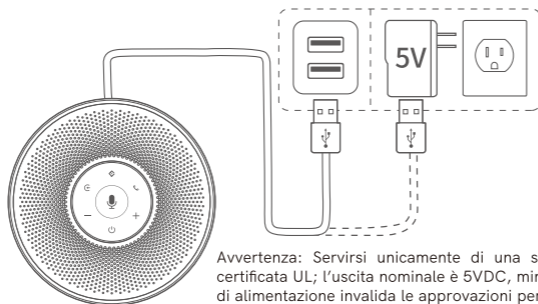

Avvertenza: Servirsi unicamente di una sorgente di alimentazione ITE certificata UL; l'uscita nominale è 5VDC, minimo 1A. L'uso di altre sorgenti di alimentazione invalida le approvazioni per questo dispositivo e potrebbe causare ulteriori pericoli.

5. Controllare il livello della batteria

Premere rapidamente "  " per controllare il Livello della batteria.

Quando il dispositivo raggiunge un livello della batteria pari al 5%, la luce a forma di anello diventerà rossa, e verrà generato un prompt di segnale "batteria scarica".

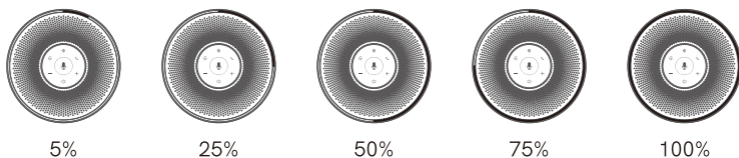

6. Uscita audio

Usare la linea AUX per collegare l'altoparlante esterno alle porte USCITA AUX di questo dispositivo, e l'audio verrà riprodotto in modo sincronizzato con questo dispositivo tramite l'altoparlante esterno.

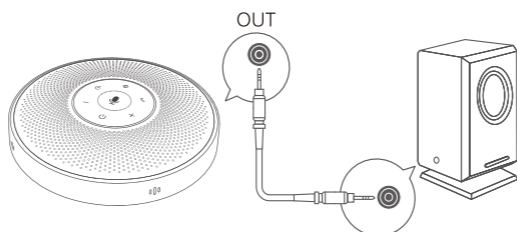

7. Funzione Daisy chain

La funzione daisy chain richiede l'uso del cavo daisy chain, che viene inserito nella porta OUT (Terminale rosso) delle due macchine utilizzando il cavo daisy chain per estendere la distanza di raccolta e riproduzione del suono in modo da ottenere uno spazio di conferenza più ampio.

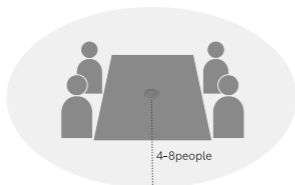

Daisy-Chain before

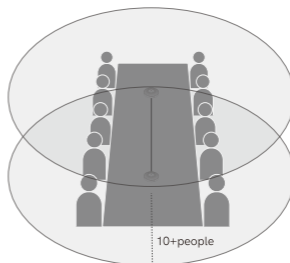

Daisy-Chain after

Nota: I cablaggi a cascata non vengono forniti in dotazione con questo M2 prodotto.

8. Ingresso audio

Usare la linea AUX per collegare il telefono alle porte INGRESSO AUX di questo dispositivo. Questo dispositivo sostituirà l'altoparlante e il microfono del telefono.

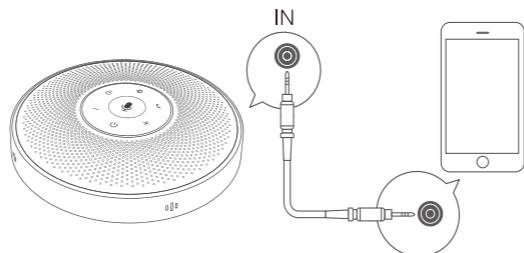

9. Impostazione porta BLOCCO

Bloccare il prodotto tramite la porta di BLOCCO per evitare furti.

Nota: La porta di BLOCCO è di tipo computer Kensington, e richiede all'utente di acquistare un lucchetto.

Informazioni sul prodotto

Potenza nominale	3W RMS
Risposta di frequenza	20Hz~20KHz(± 3 dB)
SNR	>80dB
Versione Bluetooth	V4.2
Distanza Bluetooth	20m
Sensibilità del microfono	-26dBFS
Risposta di frequenza del microfono	100Hz~8KHz(± 3 dB)
Direzionalità del microfono	360 gradi, omni-direzionale
Specifiche tecniche di caricamento	5V/1A
Dimensioni	125x125x35mm(± 5 mm)

Nota: In caso di variazioni alle specifiche, avranno la priorità le informazioni del sito web ufficiale.

Domande Più Frequenti - FAQ

Problema o fenomeno	Possibili cause	Metodo
Errore di avvio	Batteria scarica o non presente	Accedere all'adattatore per caricare
Spegnimento automatico dopo l'avvio	Batteria scarica	Accedere all'adattatore per caricare
Nessun suono	Controllare la correttezza dei collegamenti; accendere il volume	Regolare il volume del dispositivo
Errore USB	Errore in fase di utilizzo del cavo USB	Si prega di usare il cavo USB originale
Guasto AUX	Errore in fase di utilizzo del cavo AUX	Si prega di usare il cavo AUX originale
Guasto Daisy chain	Errore in fase di utilizzo del Porta di ingresso audio AUX; Errore in fase di utilizzo del cavo Daisy chain	Si prega di usare il Porta di uscita audio/Porta di Daisy chain; Si prega di usare il cavo Daisy chain originale
Errore di caricamento del dispositivo	Dispositivo di caricamento guasto o batteria carica	Sostituire con un dispositivo funzionante

Assistenza Clienti



support@emeet.ai



www.emeet.ai



US: + 1 8889595320(EST 9:00am-5:00pm Mon-Fri)

Pantalla de funciones

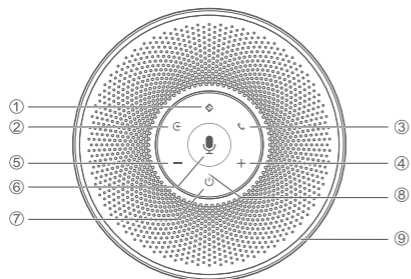

- ① Activar/Desactivar reducción de ruido por AI
- ② Botón Bluetooth
- ③ Botón responder/finalizar
- ④ Subir volumen
- ⑤ Bajar volumen
- ⑥ Silenciar/activar micrófono
- ⑦ Apagado/encendido
- ⑧ Indicador de estado
- ⑨ Luz en forma de anillo

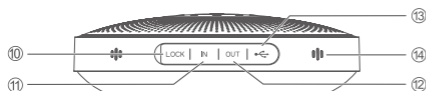

- ⑩ Bloqueo
- ⑪ Puerto de entrada de audio AUX
- ⑫ Puerto de salida de audio para auriculares/puerto Daisy cadena
- ⑬ Puerto micro USB
- ⑭ Micrófono







Control de botones

Botone	Acción	Luz
⏻	Pulsación larga	Encendido/Apagado del dispositivo
	Pulsación breve	Nivel de batería
+	Pulsación breve	Subir volumen
-	Pulsación breve	Bajar volumen
Ⓞ	Pulsación larga	Acceso al modo de emparejamiento Bluetooth
⚡	Pulsación breve	Activar/Desactivar reducción de ruido por AI
☎	Al recibir una llamada, pulsación breve	Responder
	Al recibir una llamada, mantener pulsado durante 2 segundos	Rechazar
	Durante una llamada, pulsación breve/larga	Colgar
🎤	Pulsación breve	Silenciar/Activar sonido

Indicador de estado

	Estado	Luz	
USB	Conexión USB	Encendido en color verde	●
	Dispositivo apagado y cargando	Indicador LED parpadeando en color amarillo-verde	
	Dispositivo apagado totalmente cargado	Indicador LED encendido en color amarillo-verde	●
Bluetooth	Emparejamiento Bluetooth	Parpadeando en color azul	
	Bluetooth conectado	Encendido en color azul	●
AUX IN	Conexión de audio de entrada	Encendido en color blanco	●
Daisy cadena	Daisy cadena	Encendido en color turquesa	●

Luz en forma de anillo

Estado	Luz	
Indicación de nivel de batería	Encendido en color verde	
Indicación de nivel bajo de batería	Parpadeando en color rojo	
Silencio del micrófono	Encendido en color rojo	
Indicación de volumen	Encendido en color azul	
Recepción de llamadas con Bluetooth activado	Parpadeando en color azul	
Llamada de Skype for business con USB conectado		
Skype for Business Hold	Encendido en color turquesa	

Instrucciones de funcionamiento

1. Encendido/Apagado del dispositivo

Mantenga pulsado el botón de encendido "  " durante 2 segundos para encender o apagar el dispositivo.

2. Conexión

a) Conecte el dispositivo a un PC con un cable USB para comenzar a utilizarlo.

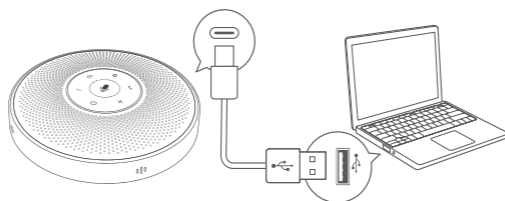

b) Conecte el dispositivo a un PC con un eMeet Audio Adapter A200 para comenzar a utilizarlo.

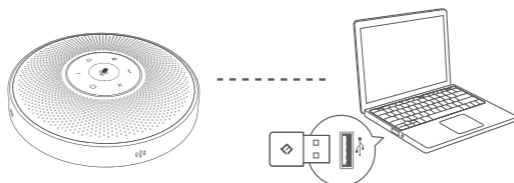

c) Después de encender el dispositivo, conéctelo con un teléfono móvil o cualquier otro dispositivo móvil vía Bluetooth para comenzar a utilizarlo.

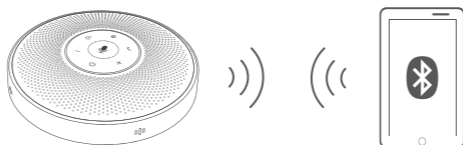

Nota:

Al encender el dispositivo, este se conectará al último ordenador/móvil conectado vía Bluetooth (para ello, es preciso que la conexión Bluetooth esté activada).

· Los diferentes modelos de productos tienen diferentes nombres de Bluetooth:

	Número de producto	Nombre de Bluetooth
①	eMeet OfficeCore M2	eMeet M2
②	eMeet OfficeCore M220 Lite	eMeet M220 Lite

3. Reducción de ruido por IA

Presione levemente el botón “  ” Reducción de ruido por IA para activar o desactivar la función de reducción de ruido por IA.

Dicha función permite reducir de forma muy significativa ciertos sonidos que pueden producirse en la sala de reuniones, como, por ejemplo, el ruido que se produce al teclear en un ordenador u otros tipos de ruido ambiental no deseados.

Nota: Con la función de reducción de ruido activada, efectúe llamadas dentro de un rango de captación de sonido de 1.5 metro para garantizar una buena captación del sonido.

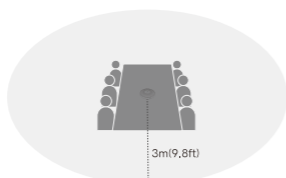

VoicelA® OFF

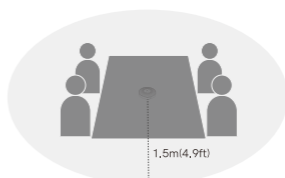

VoicelA® ON

4. Carga de la batería

a) A través del ordenador

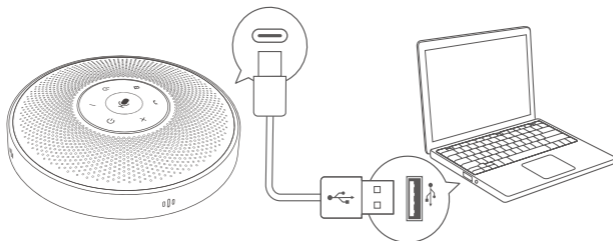

b) A través del adaptador

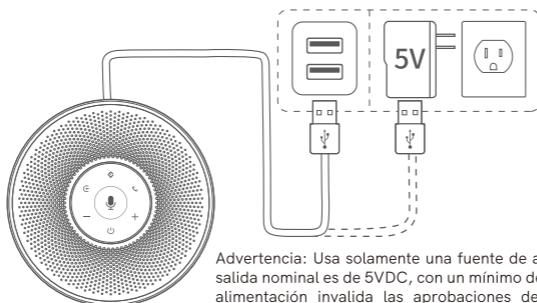

Advertencia: Usa solamente una fuente de alimentación con certificado, la salida nominal es de 5VDC, con un mínimo de 1A. El uso de otras fuentes de alimentación invalida las aprobaciones de este dispositivo y provocan potenciales daños.

5. Comprobar el nivel de la batería

Pulsa brevemente "  " para comprobar el Nivel de batería.

Cuando el dispositivo alcance el nivel del 5% de batería, la luz en forma de anillo brillará en rojo y se generará una indicación de batería baja.

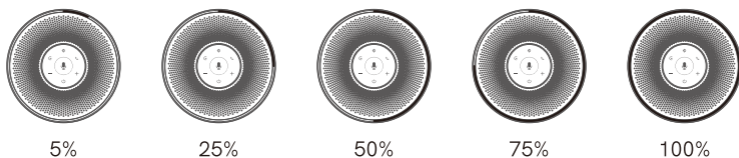

6. Salida de audio

Conecte el cable AUX para conectar un altavoz externo a los puertos AUX OUT y reproducir el audio de forma sincronizada con el dispositivo a través de dicho altavoz externo.

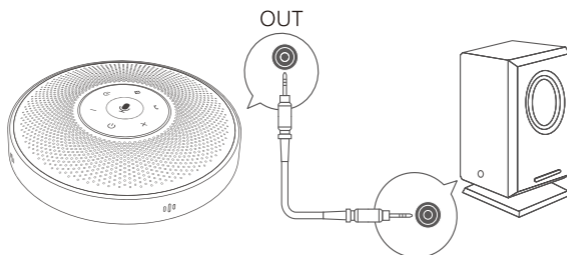

7. Función Daisy cadena

La función de Daisy cadena requiere el uso del cable de Daisy cadena, que se inserta en el puerto de SALIDA (Terminal rojo) de las dos máquinas que usan el cable de Daisy cadena para ampliar la distancia entre pick-up play mayor espacio para reuniones.

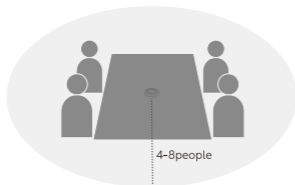

Daisy-Chain before

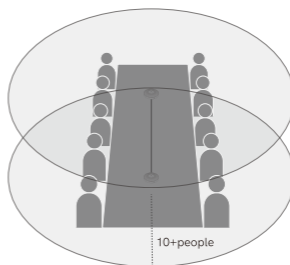

Daisy-Chain after

Nota: Con este M2 producto no se suministran los cables de cascada.

8. Entrada de audio

Utilice el cable AUX para conectar un teléfono móvil a los puertos AUX IN del dispositivo. De esta forma, el dispositivo adquirirá las funciones del altavoz y del micrófono del teléfono móvil.

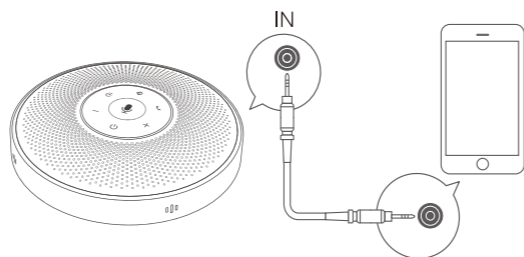

9. Ajuste del puerto de BLOQUEO

Proceda con el bloqueo del producto utilizando el puerto de BLOQUEO para prevenir posibles robos.

Nota: El puerto de BLOQUEO es un bloqueo de seguridad Kensington que precisa comprarse de forma adicional.

Información del producto

Potencia nominal	3W RMS
Respuesta de frecuencia	20Hz~20KHz(± 3 dB)
SNR	>80dB
Versión Bluetooth	V4.2
Alcance Bluetooth	20m
Sensibilidad del micrófono	-26dBFS
Respuesta de frecuencia del micrófono	100Hz~8KHz(± 3 dB)
Direccionalidad del micrófono	Omnidireccional de 360 grados
Especificaciones de carga	5V/1A
Tamaño	125x125x35mm(± 5 mm)

Nota:

Si se produjera algún cambio en las especificaciones, prevalecerá la información proporcionada en la página web oficial.

Preguntas frecuentes

Problema o fenómeno	Posible causa	Método
Fallo en el inicio	No hay es está muy baja la batería	Usa el adaptador para cargarla
Apagado automático muy pronto después de iniciarse	Poca batería	Usa el adaptador para cargarla
No hay sonido	Comprueba que las conexiones sean correctas, enciende el volumen	Ajusta el volumen del dispositivo
Fallo del USB	Error al usar el cable USB	Usa el cable USB original
Fallo AUX	Error al usar el cable AUX	Usa el cable AUX original
Fallo Daisy cadena del USB	Error al usar el Puerto de entrada de audio AUX; Error al usar el Daisy cadena cable USB	Usa el Puerto de salida de audio/puerto Daisy cadena; Usa el Daisy cadena cable USB original
Fallo en la carga del dispositivo	Incorrecta carga del dispositivo o la batería está llena	Sustitúyala con un dispositivo funcional

Servicio al cliente



support@emeet.ai



www.emeet.ai



US: + 1 8889595320(EST 9:00am-5:00pm Mon-Fri)

Affichage des boutons

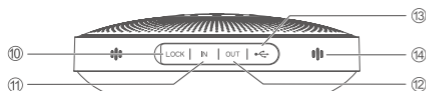
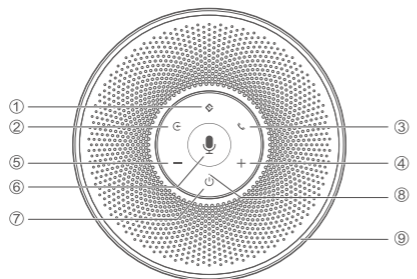



- ① Réduction du bruit AI activée/désactivée
- ② Bouton Bluetooth
- ③ Touche décrocher/raccrocher
- ④ Hausser le Volume
- ⑤ Baisser le Volume
- ⑥ Couper/rétablir le son du micro
- ⑦ Allumer/éteindre
- ⑧ Indicateur d'état à LED
- ⑨ Lumière en forme d'anneau
- ⑩ Verrouillage
- ⑪ Port d'entrée audio AUX
- ⑫ Port de sortie audio des écouteurs/Daisy chain
- ⑬ Port USB
- ⑭ Microphone







Contrôle des boutons

Boutons	Action	État
⏻	Appuyez longuement	Allumer/éteindre
	Appuyez brièvement	Affichage de batterie
+	Appuyez brièvement	Augmenter le volume
-	Appuyez brièvement	Diminuer le volume
☎	Appuyez et maintenez enfoncé pendant 2 secondes	Entrer en mode de couplage Bluetooth
🔊	Appuyez brièvement	Réduction du bruit IA activée/désactivée
☎	État de l'appel, appuyez brièvement	Répondre un appel
	État de l'appel, appuyez et maintenez enfoncé pendant 2 secondes	Rejeter
	Appel en cours, appuyez brièvement/longuement	Raccrocher
🎤	Appuyez brièvement	Désactiver/activer le microphone

Indicateur d'état à LED

	État	Lumière	
USB	Connexion USB	Passant au vert	●
	Chargement en état d'arrêt	Indicateur LED jaune-vert clignotant	
	Chargement terminé en état d'arrêt	Indicateur LED jaune-vert constamment allumé	●
Bluetooth	Couplage Bluetooth	Bleu clignotant	
	Bluetooth connecté	Bleu fixe	●
AUX IN	Connexion d'entrée audio	Passant au blanc	●
Daisy chain	Daisy chain	Passant au cyan	●

Lumière en forme d'anneau

État	Lumière	
Affichage de batterie	Vert fixe	
Affichage de batterie faible	Rouge clignotant	
Microphone désactivé	Passant au rouge	
Affichage du volume	Passant au Bleu	
Appel entrant quand le Bluetooth est connecté	Bleu clignotant	
Skype pour les appels entrants professionnels quand l'USB est connecté		
Skype for Business Hold	Passant au cyan	

Comment utiliser

1. Allumer/éteindre

Appuyez sur le bouton d'alimentation " ⏻ " et maintenez-le enfoncé pendant 2 secondes pour allumer ou éteindre.

2. Connexion

a) Une fois l'appareil connecté à un PC via USB, commencez à l'utiliser.

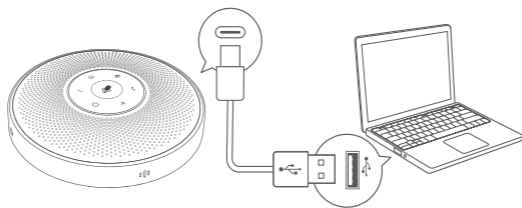

b) Une fois qu'il est connecté au PC par le eMeet Audio Adapter A200, commencez à l'utiliser.

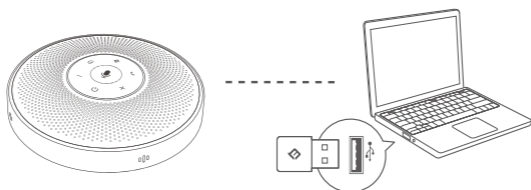

c) Une fois connecté aux appareils mobiles tels que les téléphones portables via le couplage bluetooth, commencez à l'utiliser.

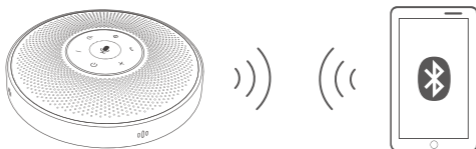

Remarque :

Lorsque l'appareil est allumé, il se connectera au dernier ordinateur/téléphone portable via Bluetooth pendant qu'il est activé.

·Différents modèles de produits ont différents noms de Bluetooth:

	Numéro de produit	Noms de Bluetooth
①	eMeet OfficeCore M2	eMeet M2
②	eMeet OfficeCore M220 Lite	eMeet M220 Lite

3. Réduction du bruit IA

Appuyez brièvement sur "  " Réduction du bruit IA pour activer/désactiver la fonction de bruit IA.

L'activation de la réduction du bruit VoicelA peut réduire considérablement certains bruits dans la scène de la réunion, tels que les tapotements sur le clavier, le bruit de la climatisation et le bruit de fond général indésirable.

Remarque : Une fois que le mode de réduction du bruit est activé, en vue de maintenir un bon effet de capture sonore, veuillez passer un appel dans un rayon de capture sonore d' 1.5 mètre.

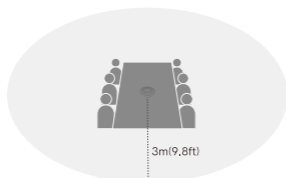

VoicelA® OFF

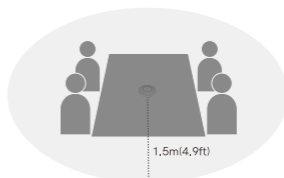

VoicelA® ON

4. Charge

a) Via l'ordinateur

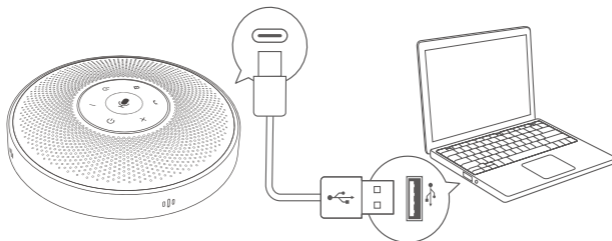

b) Via l'adaptateur

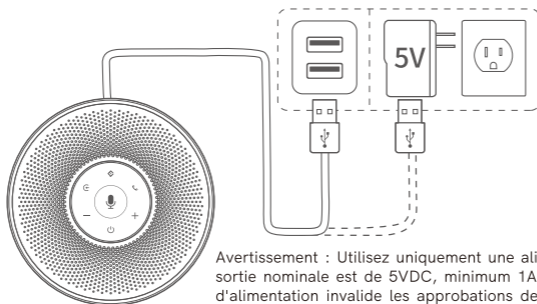

Avertissement : Utilisez uniquement une alimentation ITE certifiée UL. La sortie nominale est de 5VDC, minimum 1A. L'utilisation d'autres sources d'alimentation invalide les approbations de cet appareil et déclenche un danger potentiel.

5. Vérifiez le niveau de la batterie

Appuyez brièvement sur "  " pour vérifier le niveau de la batterie.

Lorsque la batterie de l'appareil atteint 5 % de charge, le voyant en forme d'anneau devient rouge et une alerte de batterie faible est générée.

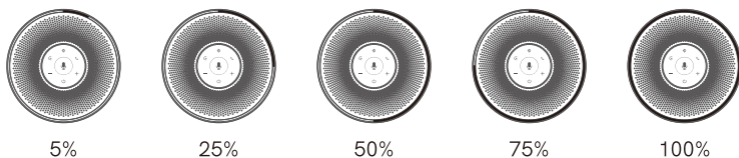

6. Sortie audio

Utilisez la ligne AUX pour connecter le haut-parleur externe aux ports SORTIE AUX de cet appareil, et le son sera reproduit de manière synchrone avec cet appareil via le haut-parleur externe.

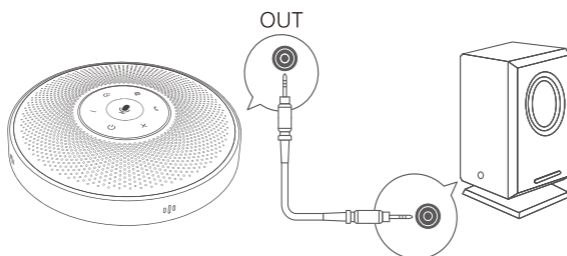

7. La fonction de Daisy chain

La fonction Daisy chain nécessite l'utilisation d'un câble Daisy chain, qui est inséré dans le port OUT (Terminal rouge) des deux machines à l'aide du câble Daisy chain, étendre la distance de ramassage & lecture du son et obtenir un plus grand espace de réunion.



Remarque: Les câbles en cascade ne sont pas fournis avec ce M2 produit.

8. Entrée audio

Utilisez le câble AUX pour connecter le téléphone aux ports ENTRÉE AUX de cet appareil. Cet appareil remplacera le haut-parleur et le microphone du téléphone.

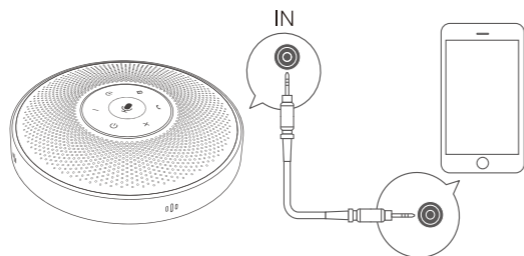

9. Réglage du port de verrouillage

Verrouillez le produit par le port de VERROUILLAGE pour éviter le vol.

Remarque : Le port de verrouillage est du type ordinateur Kensington ce qui oblige l'utilisateur à acheter un dispositif de verrouillage dans le cas contraire.

Information du produit

Puissance nominale	3W RMS
Fréquence de réponse	20Hz~20KHz(± 3 dB)
SNR	>80dB
Version Bluetooth	V4.2
Distance Bluetooth	20m
Sensibilité du confirme	-26dBFS
Réponse en fréquence du microphone	100Hz~8KHz(± 3 dB)
Directivité du microphone	360 degrés omnidirectionnel
Spécification de charge	5V/1A
Dimension	125x125x35mm(± 5 mm)

Remarque : Toute modification des spécifications est soumise aux informations du site web officiel.

FAQ

Problème ou phénomène	Causes probables	Méthode
Échec de démarrage	Batterie faible ou inexistante	Accéder à l' adaptateur pour charger
Arrêt automatique peu après le démarrage	Batterie faible	Accéder à l' adaptateur pour charger
Pas de son	Vérifiez la connexion correcte, allumer le volume	Ajuster le volume de l'appareil
Défaillance USB	Erreur d'utilisation du câble USB	Veillez utiliser le câble original USB
Échec AUX	Erreur d'utilisation du câble auxiliaire	Veillez utiliser le câble original USB
Échec Daisy chain	Erreur d'utilisation du Port d'entrée audio AUX ; Erreur d'utilisation du câble Daisy chain	Veillez utiliser le Port de sortie audio/port Daisy chain; Veillez utiliser le câble original Daisy chain USB
Panne de charge de l'appareil	Chargeur défectueux ou batterie chargée	Remplacer par un appareil fonctionnel

Service clientèle



support@emeet.ai



www.emeet.ai



US: + 1 8889595320(EST 9:00am-5:00pm Mon-Fri)