

7 DEALER MANUAL FOR DP C18.CAN



CONTENT

7.1 Important Notice	2	7.7.2 Selection of Support Levels	6
7.2 Introduction of Display	2	7.7.3 Selection Mode	6
7.3 Product Description	3	7.7.4 Headlights / backlighting	7
7.3.1 Specifications.....	3	7.7.5 ECO/SPORT Modus	7
7.3.2 Functions Overview.....	3	7.7.6 Walk Assistance	8
7.4 Display Installation	4	7.7.7 SERVICE	8
7.5 Display Information	5	7.8 Settings	9
7.6 Key Definition	5	7.8.1 "Display setting".....	9
7.7 Normal Operation	6	7.8.2 "Information".....	13
7.7.1 Switching the System ON/OFF.....	6	7.9 Error Code Definition	15

7.1 IMPORTANT NOTICE

- If the error information from the display cannot be corrected according to the instructions, please contact your retailer.
- The product is designed to be waterproof. It is highly recommended to avoid submerging the display under water.
- Do not clean the display with a steam jet, high-pressure cleaner or water hose.
- Please use this product with care.
- Do not use thinners or other solvents to clean the display. Such substances can damage the surfaces.
- Warranty is not included due to wear and normal use and aging.

7.2 INTRODUCTION OF DISPLAY

- Model: DP C18.CAN BUS
- The housing material is PC; the Display Glass is made of high-currentem material:



- The label marking is as follows:



-  **Note:** Please keep the QR code label attached to the display cable. The information from the Label is used for a later possible software update.

7.3 PRODUCT DESCRIPTION

7.3.1 Specifications

- Operating temperature: -20 °C~45 °C
- Storage temperature: -20 °C~50 °C
- Waterproof: IP65
- Bearing humidity: 30%-70% RH

7.3.2 Functional Overview

- Speed display (including top speed and average speed, switching between km and miles).
- Battery capacity indicator.
- Automatic sensors explanation of the lighting system.
- Brightness setting for backlight.
- Indication of performance support.
- Motor output power and output current indicator.
- Kilometer stand (including single-trip distance, total distance and remaining distance).
- Walk assistance.
- Setting the support levels.
- Energy consumption indicator CALORIES (Note: If the display has this function).
- Display for the remaining distance. (Depends on your riding style)
- Setting password.

7.4 DISPLAY INSTALLATION

1. Open the clamps of display and insert the rubber rings on the inside of the clamps.

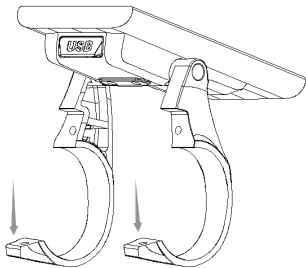

2. Now place the display on to the handlebar in the correct position. Now with 2 X M3*12 screws tighten the display into position. Torque requirement: 1N.m.

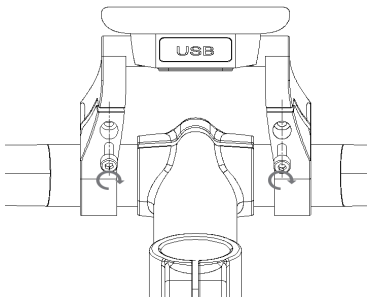
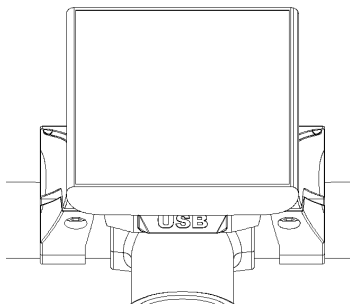

3. Open the clamp on the D-pad and place it in the correct position, Using 1 X M3*12 screw tighten the D-pad onto the handlebar. Torque requirement: 1N.m.

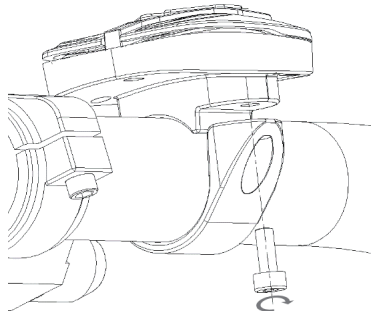
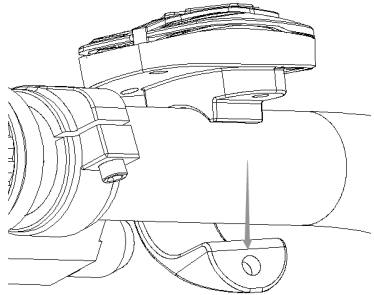

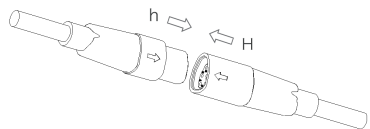

4. Please link the display to the EB-BUS cable.

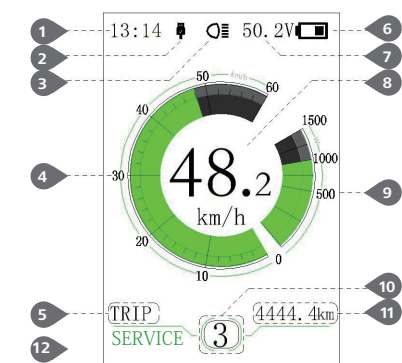

7.5 DISPLAY INFORMATION



- 1 Time
- 2 USB charging indicator displays the icon , if an external USB device is connected to the display.



- 3 The display shows  this symbol, if the light is on.
- 4 Speed Graphics
- 5 Trip: Daily kilometers (TRIP) - Total kilometers (ODO) - Top speed (MAX) - Average speed (AVG) - Range (RANGE) - Energy Consumption (CALORIES(only with torque sensor fitted)) - Travel time (TIME).
- 6 Display of battery capacity in real time.
- 7 Voltage indicator in voltage or in percent.
- 8 Digital speed display.
- 9 Power indicator in watts / amperes.
- 10 Support level/ Walking assistance 
- 11 Data: Display data, which corresponds to the current mode.
- 12 Service: Please see the service section

7.6 KEY DEFINITION





7.7 NORMAL OPERATION

7.7.1 Switching the System ON/OFF

Press and hold  (>2S) on the display to turn on the system. Press and hold  (>2S) again to turn off the system.

If the "automatic shutdown time" is set to 5 minutes (it can be set with the "Auto Off" function, See "Auto Off"), the display will automatically be turned off within the desired time when it is not in operation. If the password function is enabled, you must enter the correct password to use the system.

7.7.2 Selection of Support Levels

When the display is turned on, press the  or  (<0.5S) button to switch to the support level, the lowest level is 0, the highest level is 5. When the system is switched on, the support level starts in level 1. There is no support at level 0.

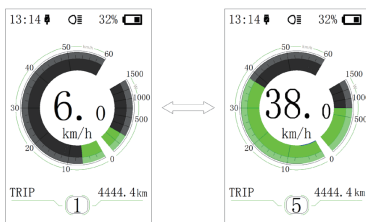

7.7.3 Selection Mode

Briefly press the  (0.5s) button to see the different trip modes.

Trip: daily kilometers (TRIP) - total kilometers (ODO) - Maximum speed (MAX) - Average speed (AVG) - Range (RANGE) - Energy consumption (CALORIES(only with torque sensor fitted)) - Travel time (TIME).

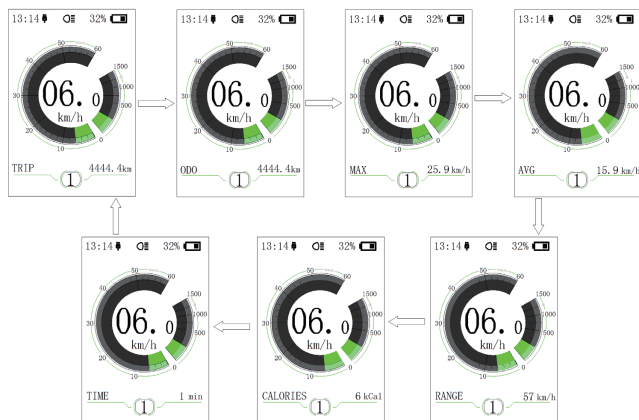

7.7.4 Headlights / backlighting

Hold the (>2S) button to activate the headlight and taillights.

Hold the (>2S) button again to turn off the headlight. The brightness of the backlight can be set in the display settings **"Brightness"**. If the display /Pedelec is switched on in a dark environment, the display backlight/headlight will automatically be switched on. If the display backlight/headlight has been manually switched off, the automatic sensor function is deactivated. You can only turn on the light manually. After switching on the system again.

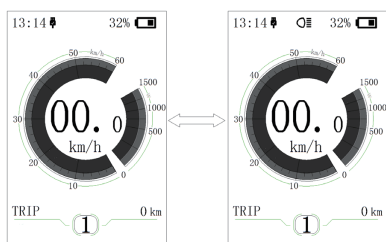





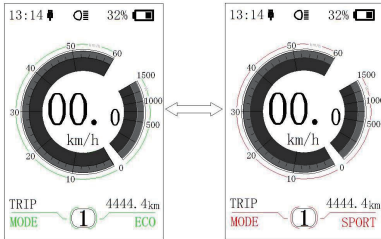

7.7.5 ECO/SPORT Modus

Press and hold the (<2S) Button, to change from ECO mode to Sport mode.
(Depending on the version of the pedelec manufacturer)



7.7.6 Walk Assistance

The Walk assistance can only be activated with a standing pedelec.

Activation: Press the  button until this symbol  appears. Next hold down the  button whilst the  symbol is displayed. Now the Walk assistance will activate. The symbol  will flash and the pedelec moves approx. 6 km/h. After releasing the  button, the motor stops automatically and switches back to level 0.

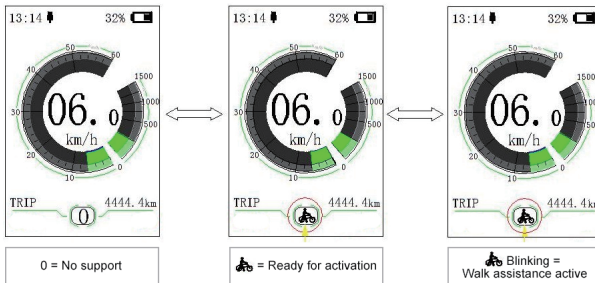

7.7.7 SERVICE

The display shows "Service" as soon as a certain number of kilometers or battery charges has been reached. With a mileage of more than 5000 km (or 100 charge cycles), the "Service" function is displayed on the display. Every 5000 km the display "SERVICE" is displayed every time. This function can be set in the display settings.

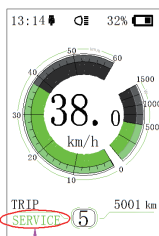

Flicker for 5s

7.8 SETTINGS

After the display is turned on, quickly press the **⏏** button twice, to access the "SETTINGS" menu. By pressing the **+** or **-** (<0.5S) button, you can select: Display Settings, Information or EXIT. Then press the **⏏** (<0.5S) button to confirm your selected option.

Or select "EXIT" and press the **⏏** (<0.5S) button to return to the main menu, or select "BACK" and press the **⏏** (<0.5S) button to return to the Settings interface.

If no button is pressed within 20 seconds, the display will automatically return to the main screen and no data will be saved.

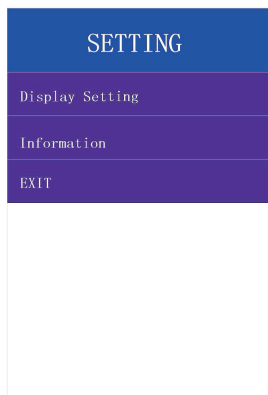

You can quickly press the **⏏** (<0.5S) button twice at any time, to return to the main screen.

7.8.1 "Display setting"

Press the **+** or **-** (<0.5S) button to select Display Settings, and then briefly press the **⏏** (<0.5S) button to access the following selections.

Display Setting	
Unit	Metric
Service Tip	OFF
Brightness	100%
Auto Off	5Min
MAX PAS	5
Power View	Power
SOC View	Percent
TRIP Reset	NO
AL Sensitivity	3
Password	>
Set. Clock	>
BACK	

7.8.1.1 "Unit" Selections in km/Miles

Press the **+** or **-** (<0.5S) button to highlight "Unit" in the Display settings menu, and then press the **⏏** (<0.5S) button to select. Then with the **+** or **-** button choose between "Metric" (kilometer) or "Imperial" (Miles). Once you have chosen your desired selection, press the **⏏** (<0.5S) button to save and exit to the "Display setting" interface.

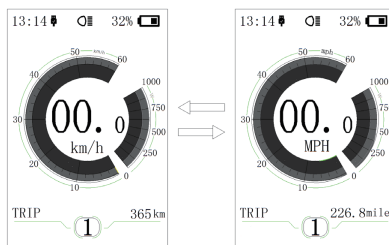

7.8.1.2 "Service Tip" Switching the notification on and off

Press the **+** or **-** (<0.5S) button to highlight "Service tip" in the Display settings menu, and then press **i** (<0.5S) to select. Then with the **+** or **-** button choose between "ON" or "OFF". Once you have chosen your desired selection, press the **i** (<0.5S) button to save and exit to the "Display setting" interface.

7.8.1.3 "Brightness" Display brightness

Press the **+** or **-** (<0.5S) button to highlight "Brightness" in the Display settings menu. Then press **i** (<0.5S) to select. Then with the **+** or **-** button choose between "100%" / "75%" / "50%" / "30%" / "10%". Once you have chosen your desired selection, press the **i** (<0.5S) button to save and exit to the "Display setting" interface.

7.8.1.4 "Auto Off" Set Automatic system switch off time

Press the **+** or **-** (<0.5S) button to highlight "Auto Off" in the Display settings menu, and then press **i** (<0.5S) to select. Then with the **+** or **-** button choose between "OFF", "9"/"8"/"7"/"6"/"5"/"4"/"3"/"2"/"1", (The numbers are measured in minutes). Once you have chosen your desired selection, press the **i** (<0.5S) button to save and exit to the "Display setting" interface.

7.8.1.5 "MAX PAS" Support level

(Function not available with ECO/SPORT display)

Press the **+** or **-** (<0.5S) button to

highlight "Max Pass" in the Display settings menu, and then press **i** (<0.5S) to select. Then with the **+** or **-** button choose between "3/5/9" (the amount of support levels). Once you have chosen your desired selection, press the **i** (<0.5S) button to save and exit to the "Display setting"

7.8.1.6 "Default Mode" Set for ECO/Sport mode

Press the **+** or **-** (<0.5S) button to highlight "Default Mode" in the Display settings menu. Then press **i** (<0.5S) to select. Then with the **+** or **-** button choose between "ECO" or "Sport". Once you have chosen your desired selection, press the **i** (<0.5S) button to save and exit to the "Display setting" interface.

7.8.1.7 "Power View" Setting the power indicator

Press the **+** or **-** (<0.5S) button to highlight "Power View" in the Display settings menu, and then press **i** (<0.5S) to select. Then with the **+** or **-** button choose between "Power" or "Current". Once you have chosen your desired selection, press the **i** (<0.5S) button to save and exit to the "Display setting" interface.

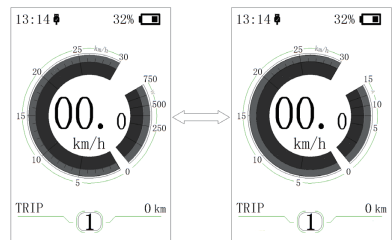

7.8.1.8 "SOC View" Battery view in volt percent

Press the **+** or **-** (<0.5S) button to highlight "SOC View" in the Display settings menu, and then press **i** (<0.5S) to select. Then with the **+** or **-** button choose between "percent" or "voltage". Once you have chosen your desired selection, press the **i** (<0.5S) button to save and exit to the "Display setting"

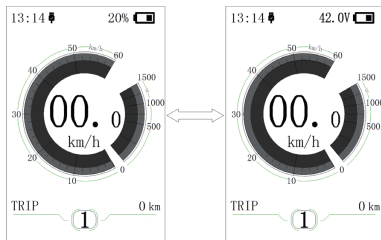

7.8.1.9 "TRIP Reset" Reset mileage

Press the **+** or **-** (<0.5S) button to highlight "TRIP Reset" in the Display settings menu, and then press **i** (<0.5S) to select. Then with the **+** or **-** button choose between "YES" or "NO". Once you have chosen your desired selection, press the **i** (<0.5S) button to save and exit to the "Display setting"

7.8.1.10 "AL Sensitivity" Automatic headlight sensitivity

Press the **+** or **-** (<0.5S) button to highlight "AL-Sensitivity" in the Display settings menu, and then press **i** (<0.5S) to select. Then with the **+** or **-** button choose between "0" / "1" / "2" / "3" / "4" / "5" / "OFF". Once you have chosen your desired selection, press the **i** (<0.5S) button to save and exit to the "Display setting"

7.8.1.11 "Password"

Press the **+** or **-** (<0.5S) button to choose Password in the menu. Then by briefly pressing **i** (<0.5S) to enter the password selection. Now again with the **+** or **-** (<0.5S) buttons highlight "Start Password" and press the **i** (<0.5S) button to confirm. Now again using the **+** or **-** (<0.5S) Button choose between "ON" or "OFF" and press the **i** (<0.5S) button to confirm.

Now you can input your 4-digit pin code. By using the **+** or **-** (<0.5S) button choose numbers between "0-9". By briefly pressing the **i** (<0.5S) button you can move on to the next number.

After entering your desired 4-digit code, you must re-enter the 4-digits you chose, to ensure the code is correct.

After selecting a password, the next time you turn on the system it will ask you to input your password. Press the **+** or **-** (<0.5S) button to select the numbers, Then press briefly **i** (<0.5S) to confirm.

After entering the wrong number three times, the system switches off. If you have forgotten the password, please contact your retailer.

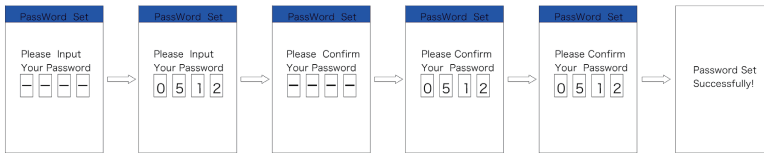

Changing the password:

Press the **+** or **-** (<0.5S) button to choose Password in the menu. Then by briefly pressing **i** (<0.5S) to enter the password section. Now again with the **+** or **-** (<0.5S) button highlight "Password set" and press the **i** (<0.5S) button to confirm. Now with the **+** or **-** (<0.5S) buttons and highlight "Reset Password" and with the **i** (<0.5S) button to confirm.

By entering your old password once, followed by inputting the new password twice, then your password will be changed.

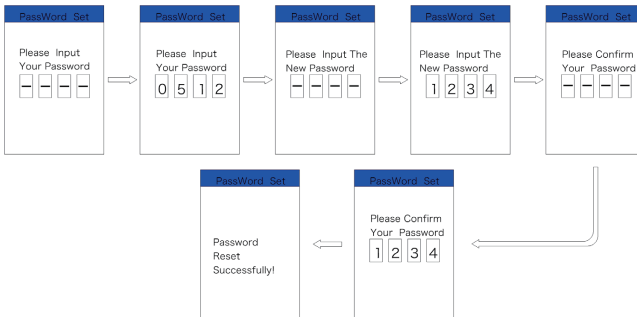

Deactivating the password:

To deactivate the password, use the **+** or **-** buttons to get to the menu point "Password" and press the **i** (<0.5S) button to highlight your selection. Press the **+** or **-** (<0.5S) button until it shows "OFF". Then press briefly **i** (<0.5S) to select.

Now enter your password, to deactivate it.

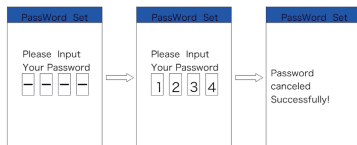

7.8.1.12 "Set Clock"

Press the **+** or **-** (<0.5S) Button to access the "Set Clock" menu. Then briefly press the **i** (<0.5S) button to confirm selection. Now press the **+** or **-** (<0.5S) button and input the correct number (time) and press the **i** (<0.5S) button to move to the next number. After entering the correct time, press the **i** (<0.5S) button to confirm and save.

7.8.2 "Information"

Once the system is turned on, quickly Press the **i** (<0.5S) button twice to access the "SETTINGS" menu. Press **+** or **-** (<0.5S) button to select "Information", and then press the **i** (<0.5S) button to confirm your selection.

Or select the point "Back" by confirming with the **i** (<0.5S) button to return to the main menu.

Information	
Wheel Size	27"
Speed Limit	25km/h
Battery Info	>
Ctrl Info	>
Display Info	>
Torque Info	>
Back	

7.8.2.1 Wheel Size and Speed Limit

The "Wheel Size" and "Speed Limit" cannot be changed, this information is here to be viewed only.

7.8.2.2 Battery Information

Press the **+** or **-** (<0.5S) button to access the Battery Info menu, and then press the **i** (<0.5S) button to select confirm. Now press the **+** or **-** (<0.5S) button and select "Back" or "Next Page". Then press the **i** (<0.5S) button to confirm, now you can read the battery information.

Content	Explanation
TEMP	Current temperature in degrees (°C)
TotalVolt	Voltage (V)
Current	Discharge (A)
Res Cap	Remaining Capacity (A/h)
Full Cap	Total Capacity (A/h)
RelChargeState	Default Loader Status (%)
AbsChargeState	Instant charge (%)
Cycle Times	Charging cycles (number)
Max Uncharge Time	Maximum time in which no charge was made (Hr)
Last Uncharge Time	
Total Cell	Number (individual)
Cell Voltage 1	Cell Voltage 1 (mV)
Cell Voltage 2	Cell Voltage 2 (mV)
Cell Voltage n	Cell Voltage n (mV)
HW	Hardware Version
SW	Software Version

NOTE: If no data is detected, "--" is displayed.

7.8.2.3 Controller Information

Press the **+** or **-** (<0.5S) button and select "CTRL Info", and then press the **i** (<0.5S) button to confirm. Now you can read the controller information. To Exit press the **i** (<0.5S) button, once "EXIT" is highlighted to return to the information settings.

Ctrl Info	
HW	*****
SW	*****
Back	

7.8.2.5 Torque Information

Press the **+** or **-** (<0.5S) button and select "Torque info", then press the (<0.5S) **i** button to read the software and hardware data in the display. To Exit press the **i** (<0.5S) button, once "EXIT" is highlighted to return to the information settings.

Torque Info	
HW	*****
SW	*****
Back	

7.8.2.4 Display Information



Press the **+** or **-** (<0.5S) button and select Display Info, then press the **i** (<0.5S) button to read the software and hardware data in the display. To Exit press the **i** (<0.5S) button, once "EXIT" is highlighted to return to the information settings.

Display Info	
HW	*****
SW	*****
Back	

7.8.2.6 Error Code

Press the **+** or **-** (<0.5S) button and select "Error Code", and then press the **i** (<0.5S) button to confirm. It shows error information for the last ten errors of the pedelec. Error code "00" means that there is no error. To return to the menu press the **i** (<0.5S) button, once "BACK" is highlighted to return to the information settings.

7.9 ERROR CODE DEFINITION

 The HMI can show the faults of Pedelec. When a fault is detected, the icon  will be indicated and one of the following error codes will be indicated too.

Note: Please read carefully the description of the error code. When the error code appears, please first restart the system. If the problem is not eliminated, please contact your dealer or technical personnel.

Error	Declaration	Troubleshooting
04	The throttle is not back in its correct position.	Check the connector from the throttle is correctly connected. If this does not solve the problem, please change the throttle.
05	The throttle has fault.	<ol style="list-style-type: none"> 1. Check the connector and cable of the throttle are not damaged and correctly connected. 2. Disconnect and reconnect the throttle, if still no function please change the throttle.
07	Overvoltage protection	<ol style="list-style-type: none"> 1. Remove and re-insert the battery to see if it resolves the problem. 2. Using the BESST tool update the controller. 3. Change the battery to resolve the problem.
08	Error with the hall sensor signal inside the motor	<ol style="list-style-type: none"> 1. Check all connectors from the motor are correctly connected. 2. If the problem still occurs, please change the motor.
09	Error with the Engine phase's	Please change the motor.
10	The temperature inside the engine has reached its maximum protection value	<ol style="list-style-type: none"> 1. Turn off the system and allow the Pedelec to cool down. 2. If the problem still occurs, please change the motor.
11	The temperature sensor inside the motor has an error	Please change the motor.
12	Error with the current sensor in the controller	Please change the controller or contact your supplier.

Error	Declaration	Troubleshooting
13	Error with the temperature sensor inside of the battery	<ol style="list-style-type: none"> 1. Check all connectors from the battery are correctly connected to the motor. 2. If the problem still occurs, please change the Battery.
14	The protection temperature inside the controller has reached its maximum protection value	<ol style="list-style-type: none"> 1. Allow the pedelec to cool down and restart the system. 2. If the problem still occurs, please change the controller or contact your supplier.
15	Error with the temperature sensor inside the controller	<ol style="list-style-type: none"> 1. Allow the pedelec to cool down and restart the system. 2. If the problem still occurs, Please change the controller or contact your supplier.
21	Speed sensor Error	<ol style="list-style-type: none"> 1. Restart the system 2. Check that the magnet attached to the spoke is aligned with the speed sensor and that the distance is between 10 mm and 20 mm. 3. Check that the speed sensor connector is connected correctly. 4. Connect the pedelec to BESST, to see if there is a signal from the speed sensor. 5. Using the BESST Tool- update the controller to see if it resolves the problem. 6. Change the speed sensor to see if this eliminates the problem. If the problem still occurs, please change the controller or contact your supplier.
25	Torque signal Error	<ol style="list-style-type: none"> 1. Check that all connections are connected correctly. 2. Please connect the pedelec to the BESST system to see if torque can be read by the BESST tool. 3. Using the BESST Tool update the controller to see if it resolves the problem, if not please change the torque sensor or contact your supplier.

Error	Declaration	Troubleshooting
26	Speed signal of the torque sensor has an error	<ol style="list-style-type: none"> 1. Check that all connections are connected correctly. 2. Please connect the pedelec to the BESST system to see if speed signal can be read by the BESST tool. 3. Change the Display to see if the problem is solved. 4. Using the BESST Tool update the controller to see if it resolves the problem, if not please change the torque sensor or contact your supplier.
27	Overcurrent from controller	Using the BESST tool update the controller. If the problem still occurs, please change the controller or contact your supplier.
30	Communication problem	<ol style="list-style-type: none"> 1. Check all connections on the pedelec are correctly connected. 2. Using the BESST Tool run a diagnostics test, to see if it can pinpoint the problem. 3. Change the display to see if the problem is solved. 4. Change the EB-BUS cable to see if it resolves the problem. 5. Using the BESST tool, re-update the controller software. If the problem still occurs please change the controller or contact your supplier.
33	Brake signal has an error (If brake sensors are fitted)	<ol style="list-style-type: none"> 1. Check all connectors are correctly connected on the brakes. 2. Change the brakes to see if the problem is solved. <p>If problem continues Please change the controller or contact your supplier.</p>
35	Detection circuit for 15V has an error	Using the BESST tool update the controller to see if this resolves the problem. If not, please change the controller or contact your supplier.
36	Detection circuit on the keypad has an error	Using the BESST tool update the controller to see if this resolves the problem. If not, please change the controller or contact your supplier.

Error	Declaration	Troubleshooting
37	WDT circuit is faulty	Using the BESST tool update the controller to see if this resolves the problem. If not, please change the controller or contact your supplier.
41	Total voltage from the battery is too high	Please change the battery.
42	Total voltage from the battery is too low	Please Charge the battery. If the problem still occurs, please change the battery.
43	Total power from the battery cells is too high	Please change the battery.
44	Voltage of the single cell is too high	Please change the battery.
45	Temperature from the battery is too high	Please let the pedelec cool down. If problem still occurs, please change the battery.
46	The temperature of the battery is too low	Please bring the battery to room temperature. If the problem still occurs, please change the battery.
47	SOC of the battery is too high	Please change the battery.
48	SOC of the battery is too low	Please change the battery.
61	Switching detection defect	1. Check the gear shifter is not jammed. 2. Please change the gear shifter.
62	Electronic derailleur cannot release.	Please change the derailleur.
71	Electronic lock is jammed	1. Using the BESST tool update the Display to see if it resolves the problem. 2. Change the display if the problem still occurs, please change the electronic lock.
81	Bluetooth module has an error	Using the BESST tool, re-update the software onto the display to see if it resolves the problem. If not, Please change the display.