

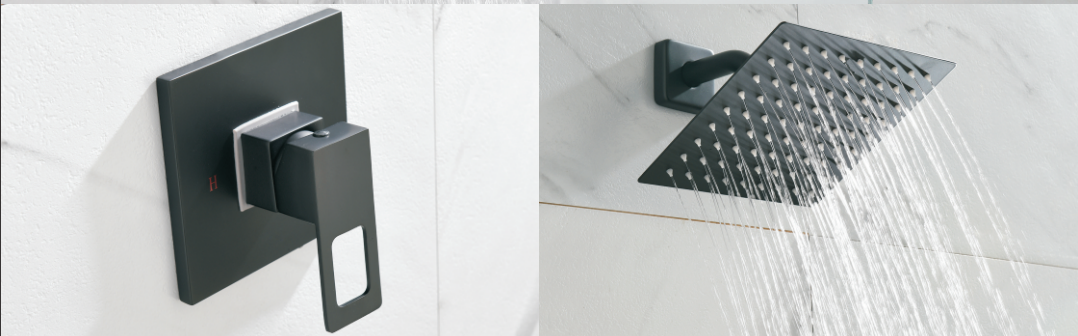

# INSTALLATION INSTRUCTION



**CONCEALED SHOWER**

# UNITED STATES CERTIFICATION

**IAPMO RESEARCH AND TESTING, INC.**  
5051 East Philadelphia Street, Culver City, CA 90230 • (805) 472-4200 • Fax: (805) 472-4244 • www.iapmo.org





## CERTIFICATE OF LISTING

IAPMO Research and Testing, Inc. is a product certification body which tests and reports compliance with the requirements of applicable laws and regulations and certifies that the products listed on this certificate comply with the requirements of applicable laws and regulations. The listing is based on the information provided by the manufacturer and is not a guarantee of performance. The listing is not a warranty and does not constitute an endorsement of the product or the manufacturer. The listing is not a recommendation of the product or the manufacturer. The listing is not a guarantee of performance. The listing is not a warranty and does not constitute an endorsement of the product or the manufacturer. The listing is not a recommendation of the product or the manufacturer.

**Effective Date:** April 2024      **Exp. Date:** 12/31/2027      **Roll Over:** March 2024

**Product:** **REWORK FLEXIBLE FITTINGS - DRAGAETA**      **File No.:** MC-1976

**Manufacturer:** **ReWork Flexible Fittings, Technology Inc., USA**



**Manufacturer's Address:** **15150 E. 1st Ave., Suite 100, Denver, Colorado 80231, USA**

**Identification:** Each listing recipient shall bear permanent legible markings to identify the manufacturer. This marking shall be on the tank top, headcap, or other such items to identify the manufacturer. The product shall also bear all other markings required by the standard. The marking shall be applied in ink to be visible after installation. The product or packaging shall also bear the UPC identification mark along with the manufacturer's name.

**Characteristics:** Rework Flexible Fittings compliant to be installed in accordance with the manufacturer's instructions and the requirements of the latest edition of the relevant drinking code.

**Products listed on this certificate have been tested by an IAPMO R&T-recognized laboratory. Their compliance has been determined based on the Laboratory's compliance with the applicable requirements of ASSE 1003.**

**Products are in compliance with the following code(s):**  
- Uniform Plumbing Code (UPC)

  
 John Collins, Director of Operations      Ron Ching, Director of Operations



**IAPMO RESEARCH AND TESTING, INC.**  
5051 E. Philadelphia Street, Culver City, CA 90230 • (805) 472-4200 • Fax: (805) 472-4244 • www.iapmo.org





## IAPMO R&T Product Listing

See IAPMO R&T Catalog for details on all listings.

**Product:** **REWORK FLEXIBLE FITTINGS**      **File No.:** MC-1976

**Manufacturer:** **ReWork Flexible Fittings, Technology Inc., USA**

**Manufacturer's Address:** **15150 E. 1st Ave., Suite 100, Denver, Colorado 80231, USA**

**Identification:** Each listing recipient shall bear permanent legible markings to identify the manufacturer. This marking shall be on the tank top, headcap, or other such items to identify the manufacturer. The product shall also bear all other markings required by the standard. The marking shall be applied in ink to be visible after installation. The product or packaging shall also bear the UPC identification mark along with the manufacturer's name.

**Characteristics:** Rework Flexible Fittings compliant to be installed in accordance with the manufacturer's instructions and the requirements of the latest edition of the relevant drinking code.

**Products listed on this certificate have been tested by an IAPMO R&T-recognized laboratory. Their compliance has been determined based on the Laboratory's compliance with the applicable requirements of ASSE 1003.**

**Products are in compliance with the following code(s):**  
- Uniform Plumbing Code (UPC)

  
 John Collins, Director of Operations      Ron Ching, Director of Operations

**IAPMO RESEARCH AND TESTING, INC.**  
5051 E. Philadelphia Street, Culver City, CA 90230 • (805) 472-4200 • Fax: (805) 472-4244 • www.iapmo.org





## CERTIFICATE OF LISTING

IAPMO Research and Testing, Inc. is a product certification body which tests and reports compliance with the requirements of applicable laws and regulations and certifies that the products listed on this certificate comply with the requirements of applicable laws and regulations. The listing is based on the information provided by the manufacturer and is not a guarantee of performance. The listing is not a warranty and does not constitute an endorsement of the product or the manufacturer. The listing is not a recommendation of the product or the manufacturer.

**Effective Date:** April 2024

**Product:** **QIANG YING HOSE FACTORY**

**Manufacturer:** **QIANG YING HOSE FACTORY**

**Manufacturer's Address:** **ROOM 1, NO. 120 JIANGNORTH ROAD, SHANGHAI, CHINA**

**Identification:** Each listing recipient shall bear permanent legible markings to identify the manufacturer. This marking shall be on the tank top, headcap, or other such items to identify the manufacturer. The product shall also bear all other markings required by the standard. The marking shall be applied in ink to be visible after installation. The product or packaging shall also bear the UPC identification mark along with the manufacturer's name.

**Characteristics:** Rework Flexible Fittings compliant to be installed in accordance with the manufacturer's instructions and the requirements of the latest edition of the relevant drinking code.

**Products listed on this certificate have been tested by an IAPMO R&T-recognized laboratory. Their compliance has been determined based on the Laboratory's compliance with the applicable requirements of ASSE 1003.**

**Products are in compliance with the following code(s):**  
- Uniform Plumbing Code (UPC)

  
 John Collins, Director of Operations      Ron Ching, Director of Operations



**IAPMO RESEARCH AND TESTING, INC.**  
**CERTIFICATE OF LISTING**

Effective Date: April 2021

**NSF/ANSI CAN 4-1**      **File Number:** 1-1208      **Valid After:** April 2026

**Product:** Drinking Water System Components - Health Effects

**Manufacturer:** QIANG YING HOSE FACTORY

**Manufacturer's Address:** ROOM 1, NO. 120 JIANGNORTH ROAD, SHANGHAI, CHINA

**Identification:** Each listing recipient shall bear permanent legible markings to identify the manufacturer. This marking shall be on the tank top, headcap, or other such items to identify the manufacturer. The product shall also bear all other markings required by the standard. The marking shall be applied in ink to be visible after installation. The product or packaging shall also bear the UPC identification mark along with the manufacturer's name.

**Characteristics:** Rework Flexible Fittings compliant to be installed in accordance with the manufacturer's instructions and the requirements of the latest edition of the relevant drinking code.

**Products listed on this certificate have been tested by an IAPMO R&T-recognized laboratory. Their compliance has been determined based on the Laboratory's compliance with the applicable requirements of ASSE 1003.**

Page 1 of 1

**IAPMO RESEARCH AND TESTING, INC.**  
**CERTIFICATE OF LISTING**

Effective Date: April 2021

**NSF/ANSI CAN 4-1**      **File Number:** 1-1208      **Valid After:** April 2026

**Product:** Drinking Water System Components - Health Effects

**Manufacturer:** QIANG YING HOSE FACTORY

**Manufacturer's Address:** ROOM 1, NO. 120 JIANGNORTH ROAD, SHANGHAI, CHINA

**Identification:** Each listing recipient shall bear permanent legible markings to identify the manufacturer. This marking shall be on the tank top, headcap, or other such items to identify the manufacturer. The product shall also bear all other markings required by the standard. The marking shall be applied in ink to be visible after installation. The product or packaging shall also bear the UPC identification mark along with the manufacturer's name.

**Characteristics:** Rework Flexible Fittings compliant to be installed in accordance with the manufacturer's instructions and the requirements of the latest edition of the relevant drinking code.

**Products listed on this certificate have been tested by an IAPMO R&T-recognized laboratory. Their compliance has been determined based on the Laboratory's compliance with the applicable requirements of ASSE 1003.**

Page 1 of 1

**IAPMO RESEARCH AND TESTING, INC.**  
**CERTIFICATE OF LISTING**

Effective Date: April 2021

**NSF/ANSI CAN 4-1**      **File Number:** 1-1208      **Valid After:** April 2026

**Product:** Drinking Water System Components - Health Effects

**Manufacturer:** QIANG YING HOSE FACTORY

**Manufacturer's Address:** ROOM 1, NO. 120 JIANGNORTH ROAD, SHANGHAI, CHINA

**Identification:** Each listing recipient shall bear permanent legible markings to identify the manufacturer. This marking shall be on the tank top, headcap, or other such items to identify the manufacturer. The product shall also bear all other markings required by the standard. The marking shall be applied in ink to be visible after installation. The product or packaging shall also bear the UPC identification mark along with the manufacturer's name.

**Characteristics:** Rework Flexible Fittings compliant to be installed in accordance with the manufacturer's instructions and the requirements of the latest edition of the relevant drinking code.

**Products listed on this certificate have been tested by an IAPMO R&T-recognized laboratory. Their compliance has been determined based on the Laboratory's compliance with the applicable requirements of ASSE 1003.**

Page 1 of 1

# BEFORE INSTALLATION

This product has been inspected and debugged by the factory to the best condition. Please do not disassemble and assemble it yourself.

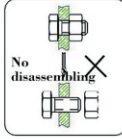

Before installing the faucet, please be sure to remove sundries and sludge from the water pipe to prevent sundries from blocking the faucet.

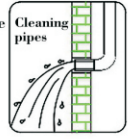

1. Please read the manual firstly before installation;
2. Please check the condition of all the parts, and the installation tools are not included, please prepare it by yourself;
3. User manual includes matters needing attention during installation, please keep it properly;
4. The size chart in the manual is for reference only, please refer to the actual product that you receive.

## Recommend Tools :



PTFE Tape



Hex Key

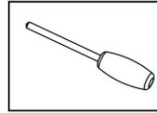

Slotted Screwdriver

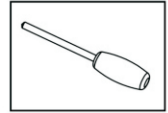

Phillips Screwdriver

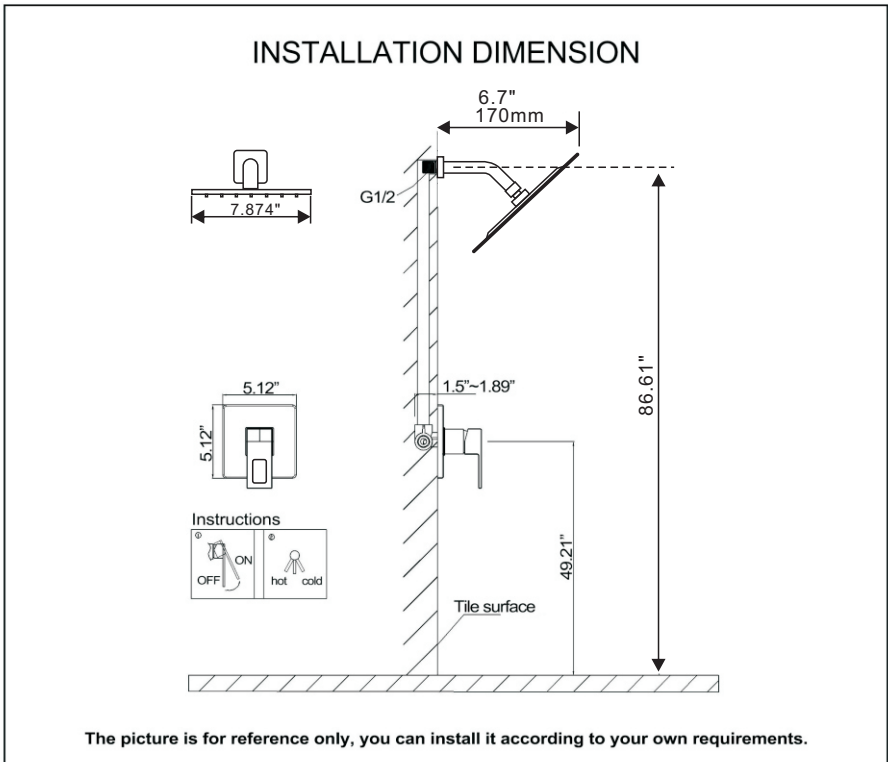

## INSTALLATION STEPS

- 1.The sundries at the connection area must be cleared before installation to avoid blockage or leakage;
- 2.Connect the inlet pipe correctly as shown in the figure;
- 3.The maximum temperature of hot water is not higher than 80 °C (176°F);
- 4.Please contact seller for consultation if you need to install in other method.

①

Mark the location of screw holes on the wall, drill holes and install the water intake body

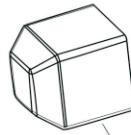
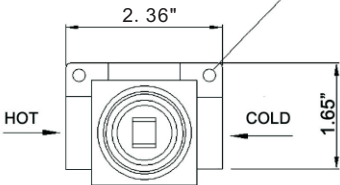

In the process of burying the wall, please do not remove the protective cover and avoid touching the copper sleeve.

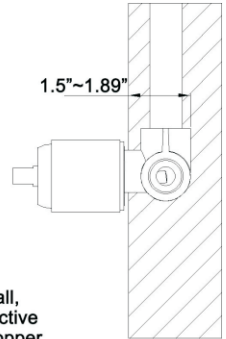

② Please install other parts in the order as shown in the figure below when the valve mounted to the wall:

- 1.Remove the lid of the Embedded Box;
- 2.Place the trim plate;
- 3.Mount the handles.

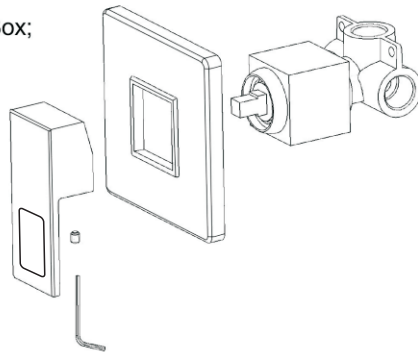

## CLEANING CARE

In order to keep the appearance of faucet clean,bright and good performance, please take care of the faucet as follows;

- 1.Rinse with water only and dry with soff cotton cloth;
- 2.Use mild liquid and colorless glass cleaner to remove surface dirt and scale film, or use polish without abrasive effect;
- 3.Do not use abrasive detergent, polish, emery cloth, paper towel or scraper, etc.;
- 4.Do not use acid cleaner,or cleaner and soap with insoluble gran etc.;
- 5.In the process of use, mud my accumulate in the bubbler and make the water flow show, The bubbler can be unscrewed, rinsed with water, and then installed back in place.



