

## INSTALLATION



ALINA-W1MRL2432/2436/2836/4024/4832/6028/7236

## LED BATHROOM MIRROR Lighting and Defogger

### IMPORTANT SAFETY INSTRUCTIONS

When using an electrical furnishing, basic precautions should always be followed, Requires two(2) person in installation.



#### DANGER

**READ AND FOLLOW ALL INSTRUCTIONS BEFORE USING THIS MIRROR.**



#### WARNING

To reduce the risk of burns, fire, electric shock or injury to persons. Use this furnishing only for its intended use as described in these instructions. Do not use attachments not recommended by the manufacturer. Never drop or insert any object into any opening. Do not use outdoors.



#### WARNING

Risk of electric shock. Connect this furnishing to a properly grounded circuit only. See Grounding instructions.

### GROUNDING INSTRUCTIONS:



#### WARNING

This product must be connected to a grounded metal, permanent wiring system, or an equipment-grounding conductor must be run with the circuit conductors and connected to the equipment-grounding terminal or lead on the product.

An Electrical option cabinet must be wired to a 20 Amp GFI (Ground Fault Interrupter) protected circuit when used in bathrooms and all other locations required by the National Electric Code.

---

**NOTE:** To ensure the normal use of product, it is required to set out wires as per the regulations of IEE. The product is only applicable to the indoor installation. The installation must be executed by a professional electrician, wrong installation may lead to product damage and personal injury.

---

PLEASE SAVE THESE INSTRUCTIONS FOR FUTURE REFERENCE

## INSTALLATION



ALINA-W1MRL2432/2436/2836/4024/4832/6028/7236

# LED BATHROOM MIRROR

Lighting and Defogger

## TOOLS REQUIRED FOR ASSEMBLY

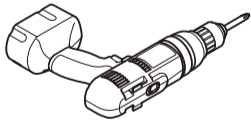

Electrical Drill



1/8" Drill Bit

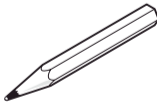

Pencil



Phillips  
Screwdriver



Tape Measure

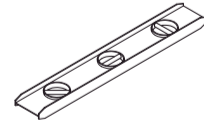

Level

## PARTS INCLUDED

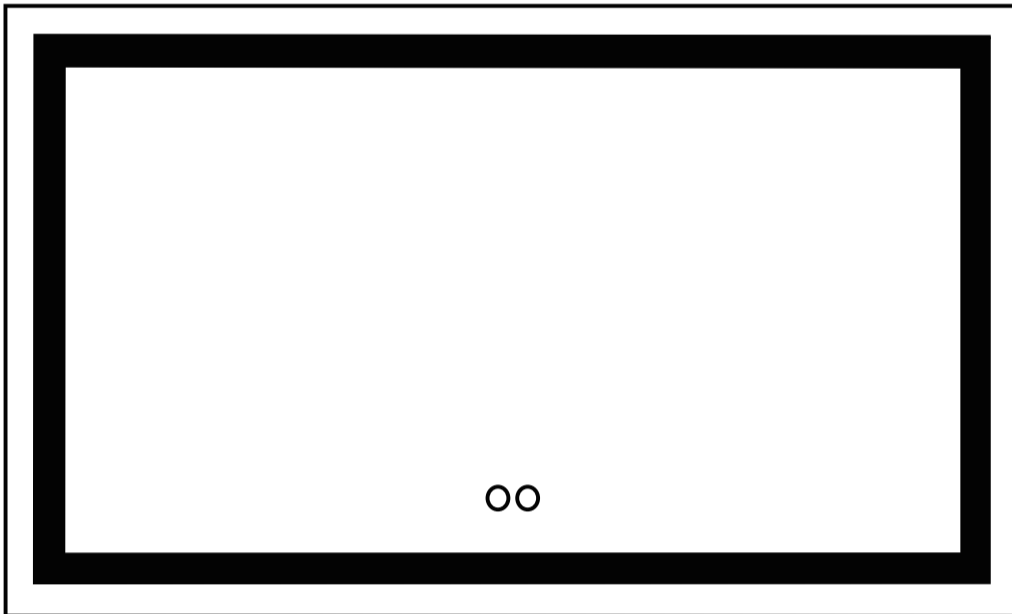

Mirror



SCREW

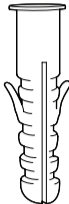

WALL PLUG

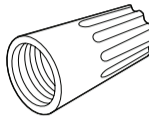

WIRE CONNECTOR

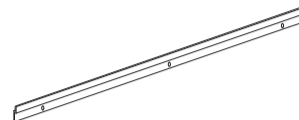

HANGING BAR



**NOTE:** Determine overall mirror dimensions before proceeding to installation.

\*All dimensions & specifications are approximate and subject to change without notice.

\*Accessories and parts may vary from the picture above. Depends on the product model and size.

## INSTALLATION



ALINA-W1MRL2432/2436/2836/4024/4832/6028/7236

# LED BATHROOM MIRROR

Lighting and Defogger

## ELECTRIC CONNECTIONS

**ALL WIRING SHOULD BE DONE BY A QUALIFIED LICENCED ELECTRICIAN**

- ⚠ **WARNING:** Shut off power before wiring the mirror.
- ⚠ **WARNING:** An Electrical option mirror must be wired to a 20 Amp GFI (Ground Fault Interrupter) protected circuit when used in bathrooms and all other locations required by the National Electric Code.
- ⚠ **WARNING:** This mirror must be connected to a grounded, metal permanent wiring system or an equipment-grounding conductor must be run with the circuit conductors and connected to the equipment grounding terminal or lead on the mirror.
- ⚠ **CAUTION:** Requires 120 VAC 20 Amp GFI protected circuit.

### vertical hanging

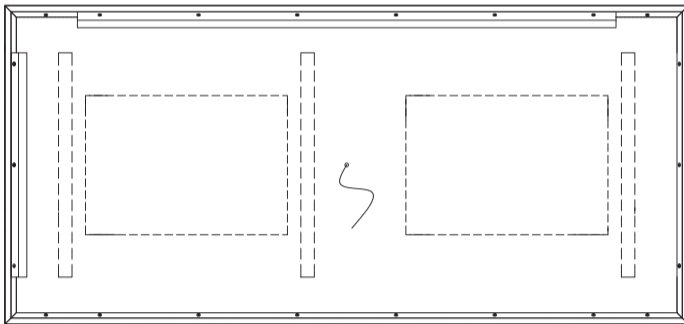

### horizontal hanging

**Electric wiring:** Be sure to provide enough wire to make the proper and safe connection to the Field/Power.

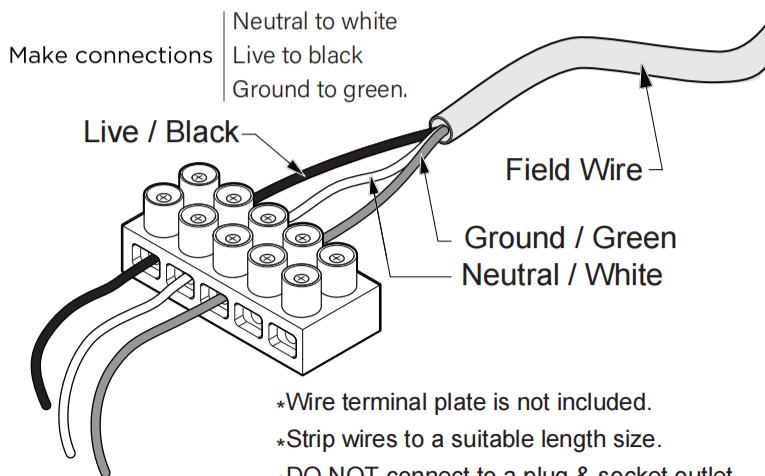

### MIRROR FEATURES

- 5mm copper free silver mirror
- High output LED lighting:  
CRI 90+, 3000-6000K CCT, IP44
- Color Temperature changing touch switch for surface LED
- Vertical and horizontal mount options
- Defogger

## INSTALLATION INSTRUCTIONS

**1**

### PLACEMENT

Select the desired position of the mirror.  
Level and mark the location.  
(vertical and horizontal mounting options)

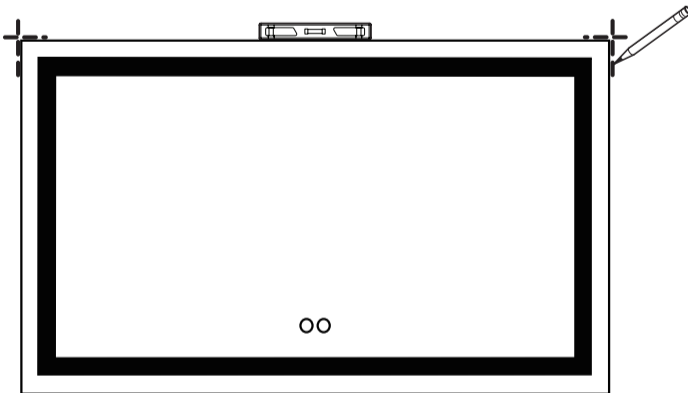

**2**

### SUPPORT LOCATION

Measure the hanging bar holes and mark the drilling locations ensure marking are leveled.

**A**

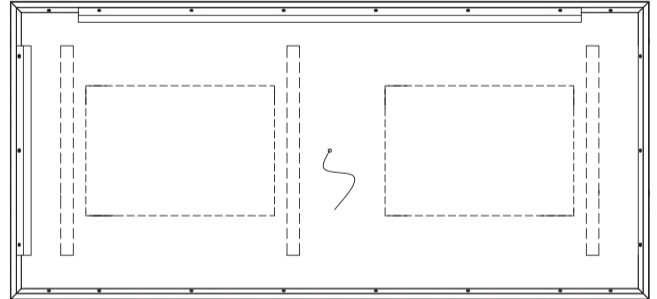

**B**



**3**

### INSTALL SCREWS

Using a drill, make holes on solid wall, and fill with supplied plugs and screws into hanging bar holes tightly.

**A**

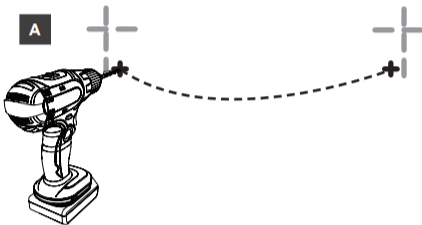

**B**

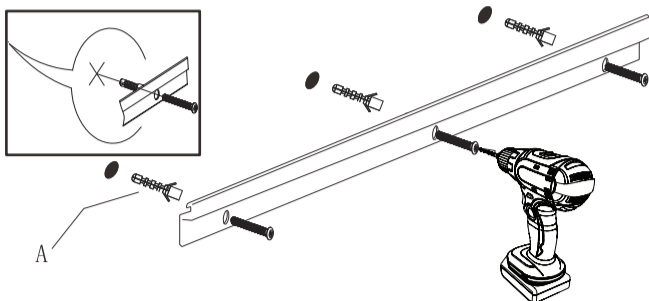

**4**

### POWER OFF

Please turn off all the power before the mirror wires connection.

### Power Off

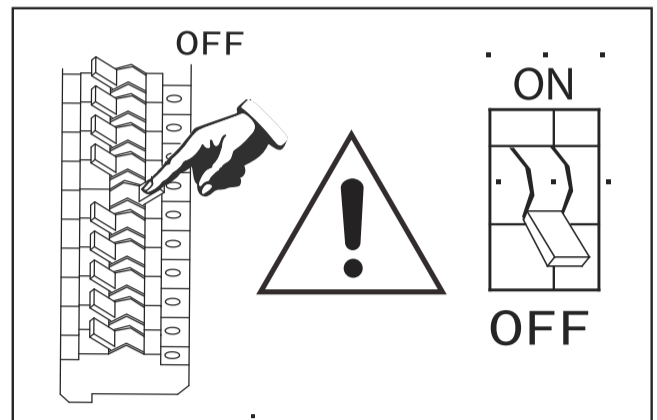

## INSTALLATION INSTRUCTIONS

### 5 CONNECTION

Use the wire connector connect to external power supply, and pusing the power supply wires into the junction box.

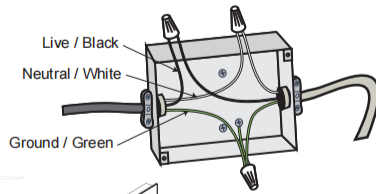

\*Junction box is not included\*

Make connections Neutral to white  
Live to black  
Ground to green.

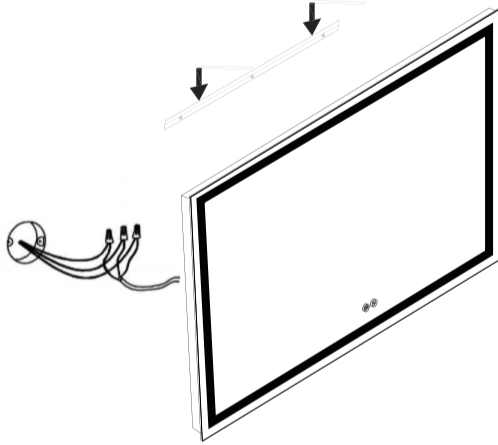

**Warning:** Strip wires to a suitable length. DO NOT connect the hardwire to a plug & socket outlet

### 6

**Turn on the power**

Hang up the mirror stable then turn on the power.

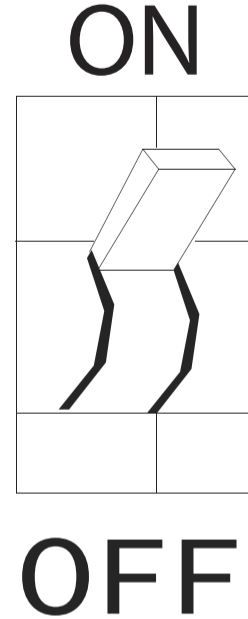

## FINAL ASSEMBLY

### How to use Defogger Switch and Dimmer Switch:

#### Left touch Sensor



ON/OFF Anti-fog(The defogger power will automatically turn off after an hour)

#### Right Touch Sensor



ON/OFF Lighting

Quick Tap-tap(two times) light color change, brightness control by holding

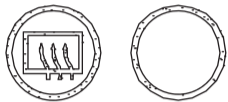

"Switch" sign

#### OPERATION

- 1.Touch the sensor button to turn ON the light. Quick tap-tap twice to change the light temperature from 3000K, 4000K to 6000K.
- 2.Touch and hold the Light ON sensor button to dim the light. Release the button when the light reaches the desired brightness setting.
- 3.Touch the sensor button to turn OFF the light.

The mirrors are equipped with a memory feature to preserve the previous brightness setting.

**\*Suggestion:** Turn off the mirror power supply if you don't use it for a long time.

## WARNINGS:

1. Please do not use if you found the mirror have been broken.
2. Never put any sharp or heavy material on the mirror surface, other wise the glass mirror will be broken and body injury accidents may occur .
3. Turn off the power switch in storm lightning weather to avoid electric parts damage.

## Use and Maintenance:

### CAUTION:

#### ● USE

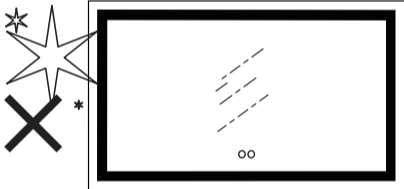
<p><b>1</b></p> 	<p>1. To avoid damage, do NOT knock the mirror with any hard objects;</p>
---	---

#### ● CLEANING

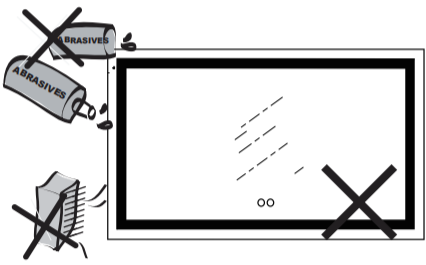
<p><b>2</b></p> 	<p>2. Do NOT clean the mirror with caustic cleaner. Do NOT wipe the mirror with Bristle brush;</p>
---	--

#### ● MAINTENANCE

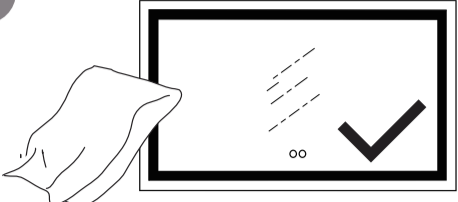
<p><b>3</b></p> 	<p>3. For daily maintenance, please use soft cloth and mild cleaner to clean the mirror.</p>
---	--

**LIMITED WARRANTY****LIMITED WARRANTY TWO YEARS TERM:**

WELLFOR warrants to the original purchaser that, it will, at its election repair, replace, or make appropriate adjustment to products made by this company shown to have significant defects in material or workmanship which are reported to WELLFOR in writing within two (2) years from the date of delivery. WELLFOR is not responsible for installation costs. The warranty is void in the event the product is damaged in transit, or if damage or failure is caused by abuse, misuse, abnormal usage, faulty installation, damage in an accident, improper maintenance, or any repairs other than those authorized by WELLFOR. At the expiration of the two years warranty period, WELLFOR shall be under no further obligation under any warranty, expressed or implied, including the implied warranty of merchantability. WELLFOR shall not be liable for any consequential damages arising out of or in connection with the use or performance of its products. Some states do not allow limitations on how long an implied warranty lasts or do not allow the exclusion or limitation of incidental or consequential damages, so the above limitation or exclusion may not apply to you. Any liability against WELLFOR under any implied warranty, including the warranty of merchantability, is expressly limited to the terms of this warranty. Permission to return any merchandise under this warranty must be authorized by WELLFOR and returned prepaid by the purchaser. Claims under this warranty should be sent directly to your dealer.

For customer support please call 206.809.0093 weekdays 9:00 to 6:00 PST, or by email: [service@wellfor.com](mailto:service@wellfor.com).

For more information: [www.wellfor.com](http://www.wellfor.com)