

# Redlino

**TREADMILL**

**MODEL: JK30H-9**

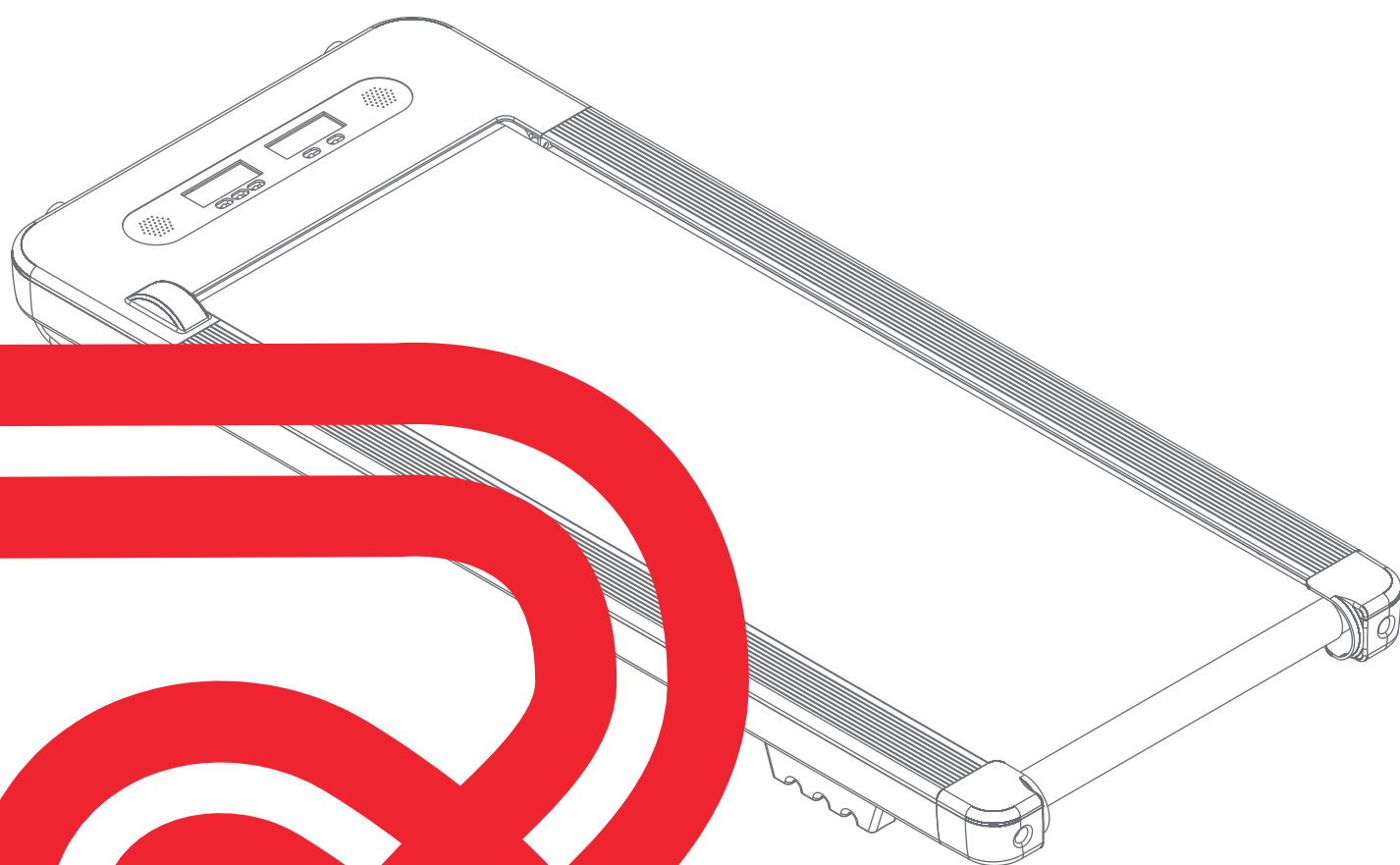

**PRODUCT  
USER GUIDE**

Thank you for purchasing this Redliro product. Questions, problems, missing parts? Before returning to your retailer, contact our Customer Service Department to receive more complete service, please email your order number to: [service@redliro.com](mailto:service@redliro.com)

*Response  
Time*



Emailing us with the information above will be the best method to receive a response during peak business hours.

**URL : [www.redliro.com](http://www.redliro.com)**

FOR INFORMATION REGARDING WARRANTY, REPLACEMENT PARTS, AND REFUNDS,  
PLEASE CONTACT OUR CUSTOMER SUPPORT.

# CONTENT

Service .....	2
Safety Information .....	4
Product Specifications .....	5
Package List .....	6
Product Structure .....	7
Introduction to Display .....	8
Remote Control Instructions.....	9
Battery Replacement .....	12
Instructions for Using the Treadmill.....	13
Preparation before use .....	13
Instructions for Use .....	13
Product Maintenance .....	17
Daily Cleaning .....	17
Routine Maintenance .....	18
Troubleshooting and Handling .....	20
Workout Guide .....	24
Warranty .....	25

## SAFETY INFORMATION

**TO REDUCE THE RISK OF INJURY, PLEASE READ INSTRUCTIONS IN FULL BEFORE USE.**



- Intended for at-home use only. Please only use in an area with 3 - 6 feet of free space around your device. Do not operate your device on a carpet more than 0.5 inches thick or near water.
- Treadmill is not intended for use by children or those with physical, sensory, or cognitive impairments.
- To avoid injury, do not disassemble this machine without guidance of manufacturer.
- This product only works with electrical outlets with a voltage between 100 and 120VAC. If your product's plug does not fit your home's outlets, do not attempt to use.
- Check all parts before use to ensure the screws and nuts are not loose.
- Keep fingers away from moving parts. Don't put your hands or feet in the space under the running belt. Keep children or pets away from the treadmill.
- Wear appropriate exercise clothes and athletic shoes while using the treadmill. Loose fitting or oversized clothing can get caught in machine. Always wear the clip with the safety key fasten to the panel while using the treadmill.
- Unstable power supply may overload the circuit. Do not plug high-power devices such as a computer into an outlet on the same circuit.
- This product can only be used by one person at a time.
- Do not place any objects on the machine. Do not stand directly on the belt when the machine is turned on.
- Keep children, pets, and household objects clear of the machine when folding and unfolding. Do not start the machine when it is folded.
- Always unplug the power cord after use before cleaning and performing maintenance.
- Only use manufacturer's accessories. Never exceed product's maximum weight capacity of 300 lbs. (136kg)
- Moisture and overheating will affect the use of the product. Please keep the machine, motor, power cord and plug away from water and high temperatures.
- If the treadmill overheats, emits smoke or a burning smell during use, please stop using it immediately and contact customer service for replacement.
- The company is not responsible for any harm caused by improper use.

## PRODUCT SPECIFICATIONS

Product configuration	Technical parameters
Input voltage	110 V
Speed range	0.5-6 km/h
Maximum load bearing	300 lbs
Package size	54.1x25.4x6.3 inches
Assembly size	50x20.87x5.12 inches
Operating area	42*15 inches
Rated power	550 W
Net/gross weight	46.3/ 57.3 lb

## PACKAGE LIST

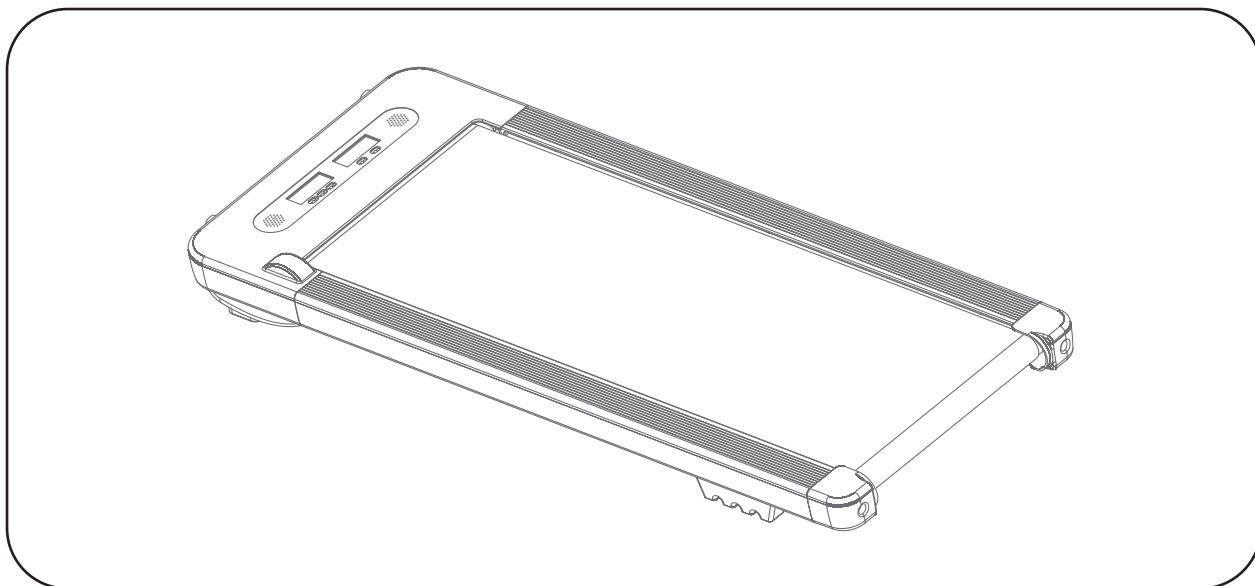

TREADMILL × 1

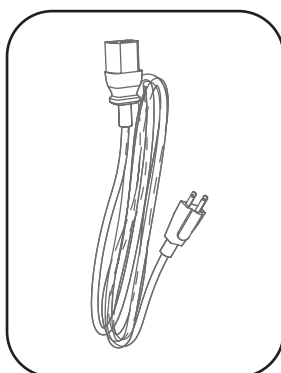

POWER CORD  
(THREE-PINPLUG) × 1

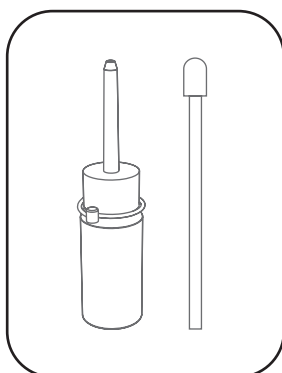

SILICONE LUBRICANT × 1

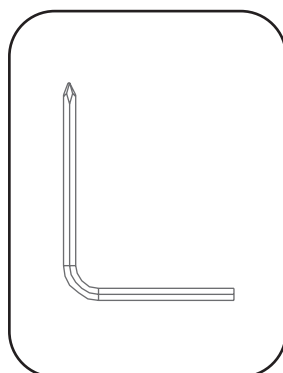

L STYLE WRENCH × 1

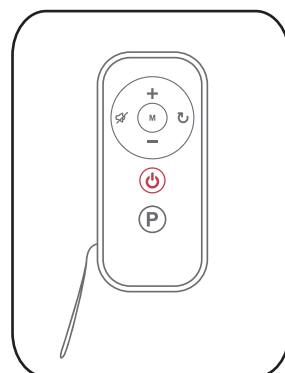

REMOTE CONTROL × 1

SERIAL NO.	DESCRIPTION	QUANTITY	UNIT
1	TREADMILL	1	PC
2	POWER CORD (THREE-PINPLUG)	1	PC
3	SILICONE LUBRICANT	1	PC
4	L STYLE WRENCH	1	PC
5	REMOTE CONTROL	1	PC

## PRODUCT STRUCTURE

**NOTE: THE RUNNING BELT IS MADE OF HEAD AND TAIL SPLICING, THERE ARE SEAM MARKS, IT IS NORMAL PROCESS PHENOMENON, AND DOES NOT AFFECT THE NORMAL USE OF THE TREADMILL.**

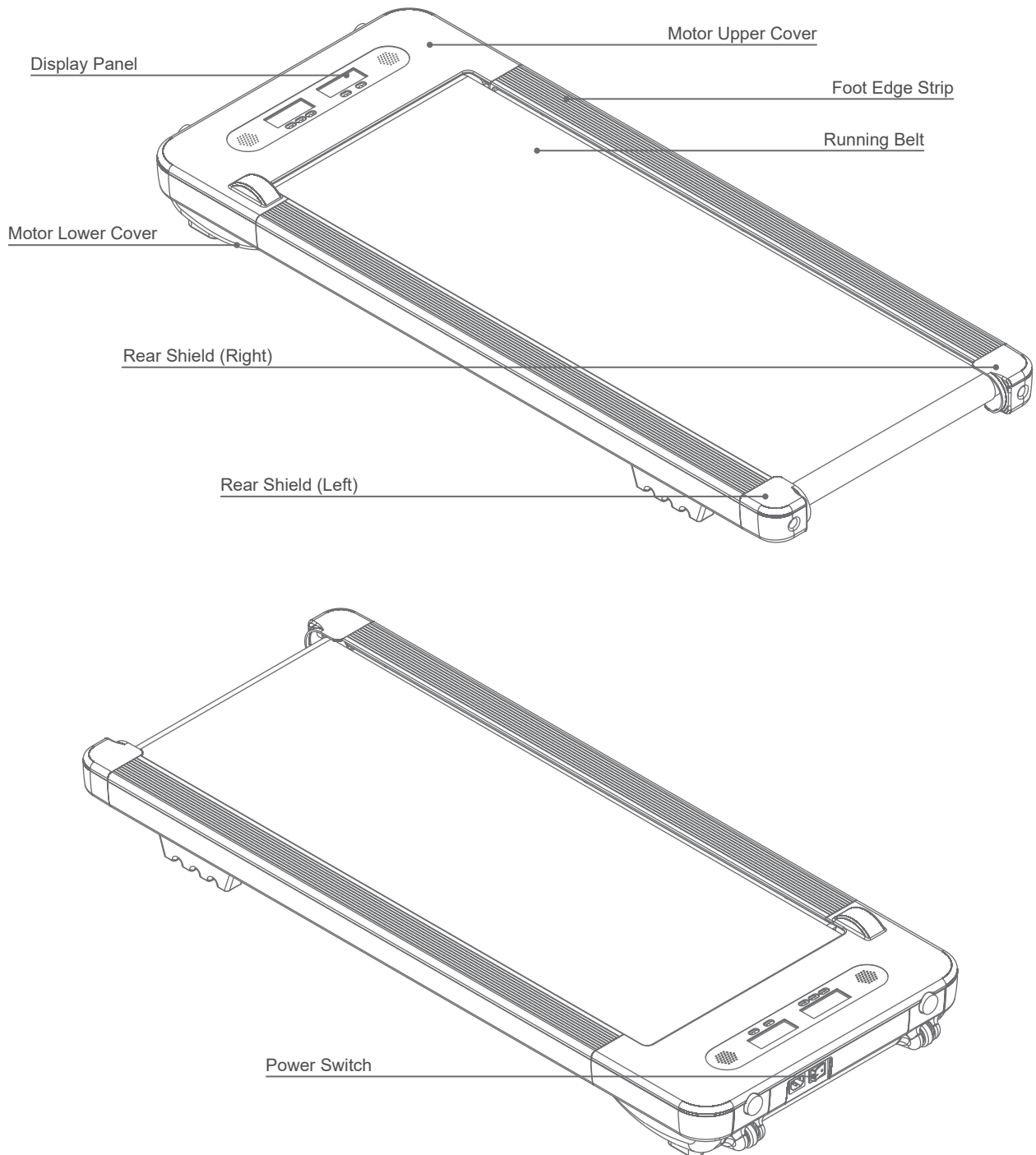

## INTRODUCTION TO DISPLAY

THE TREADMILL HAS A MAXIMUM SPEED OF 4 MPH WHEN THE HANDRAILS FOLD DOWN.

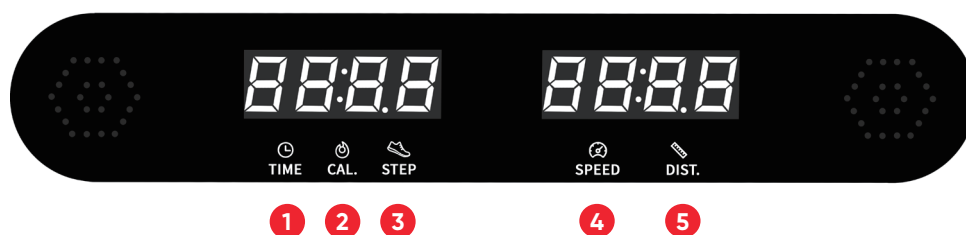

1. The **"TIME"** window has two display modes.

- Standard mode counts from 00:00 ~ 99:00 and resets to 0 when it reaches 99:00.
- The preset/custom mode allows user to set a time for length of use. Select from 5 minutes to 99 minutes. Once countdown has reached 0, your device will slowly stop and enter standby mode.

2. The **"CALORIES"** window has two display modes.

- Standard mode counts from 0 to 999.9, and resets to zero when it reaches 999.9.
- The preset/custom mode allows user to set calorie value. Select from 20 to 990. Once countdown has reached 0, your device will slowly stop and enter standby mode.

3. The **"STEP"** window displays the number of steps taken. The count is 0~9999 steps. When the step count reaches 9999, it will reset to zero.

4. The **"SPEED"** window displays the current running speed, and the speed range is 0.5mph~7.5mph.

- In preset mode, 12 preset schemes (P1 ~ P12) are displayed.

5. The **"Distance"** window has two display modes.

- In standard mode, the distance will increase from 0.0 to 99 miles, and the count will reset to zero when it reaches 99
- In preset/custom mode, the distance will be reduced from the inputted data (setting range: 1~99 miles) to 0. When the display is 0, your device will slowly stop and enter the standby state.



## REMOTE CONTROL INSTRUCTIONS

**NOTE: TO USE THE REMOTE CONTROL, YOU MUST FIRST ESTABLISH A NEW CONNECTION**

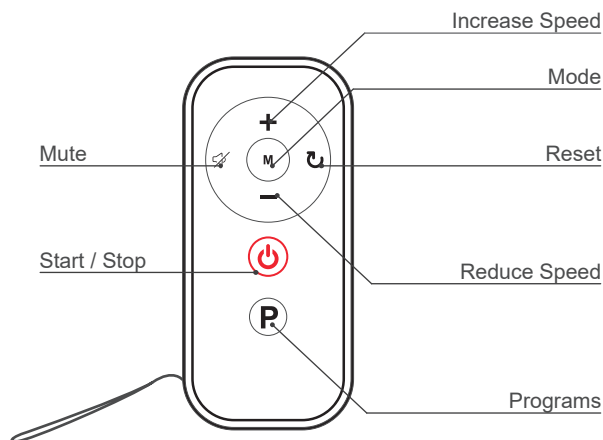

### HOW TO ESTABLISH A NEW CONNECTION

1. Ensure the treadmill is connected to the power source but keep it powered on.
2. Hold the Mute button and Reset buttons on the remote control simultaneously for 5 seconds. The light on the remote control will flash as it enters pairing mode.
3. The remote control will pair with treadmill automatically after a few seconds.

## FUNCTION OF THE REMOTE CONTROL



### **Start/Stop button:**

Press Start/Stop button in standby mode and the treadmill will start after 3 seconds. The default speed is 0.5 km/h.

Press Start/Stop button in preset/custom mode and the treadmill will start immediately, running at preset values. It will immediately begin accumulating data.

Press Stop button while running belt is in motion and the treadmill will slow down slowly and return to pause mode.

In the pause mode, press Start button and the running belt will begin moving at the previous selected program.



### **+/- button:**

Used for speed adjustment while your device is in use. Speed will be adjusted 0.1 km/h each time you press. Hold for more than 0.5 seconds and the speed will continue to increase or decrease. Can also be used to adjust settings in preset/custom mode.



### **M button:**

Press the M button while in standby mode to switch to custom mode. Select between time setting (setting range 5:00 ~ 99:00), distance setting (setting range 1 ~ 99 kilometer ) and calorie setting( setting range 20 ~ 990 ).

Press M button to change the cyclic display or fixed display mode when in use.

Cyclic display mode: The default mode when in use. The left screen displays Time, Step and Calorie in a loop. The right screen displays Speed and Distance in a loop. The display between each option in 5 second intervals.

Fixed display mode: When in cyclic display mode, press the M button to fixed the option on the left or right screen.



### **Mute button:**

Press the "Mute" button once to mute noise. Press it twice to cancel the operation.



### **Reset button:**

In the pause mode, press Reset button and the running belt will slowly return to standby mode



### **P button:**

In standby mode, the P button is used to select 12 preset automatic programs (P01 ~ P12)

The 12 preset programs have the following speeds:

TIME PROGRAMA		SET TIME/20=RUNNING TIME FOR EACH SECTION																			
P1	SPEED	1.0	2.0	3.0	4.0	4.0	3.0	4.0	4.0	4.0	3.0	4.0	4.0	4.0	4.0	4.0	2.0	3.0	4.0	3.0	2.0
P2	SPEED	1.0	3.0	4.0	4.0	4.0	2.0	4.0	2.0	4.0	4.0	4.0	4.0	4.0	4.0	4.0	2.0	4.0	4.0	3.0	2.0
P3	SPEED	1.0	4.0	4.0	1.0	4.0	4.0	1.0	4.0	4.0	4.0	4.0	2.0	4.0	4.0	1.0	2.0	4.0	3.0	3.0	2.0
P4	SPEED	1.0	4.0	2.0	2.0	2.0	4.0	2.0	4.0	4.0	2.0	2.0	3.0	4.0	1.0	2.0	4.0	4.0	4.0	4.0	2.0
P5	SPEED	1.0	3.0	4.0	3.0	4.0	4.0	3.0	1.0	2.0	4.0	4.0	4.0	4.0	2.0	3.0	4.0	1.0	4.0	4.0	3.0
P6	SPEED	1.0	2.0	2.0	4.0	3.0	1.0	4.0	2.0	3.0	2.0	1.0	4.0	2.0	3.0	4.0	1.0	2.0	4.0	1.0	3.0
P7	SPEED	1.0	4.0	4.0	4.0	4.0	2.0	4.0	3.0	4.0	4.0	1.0	2.0	3.0	4.0	1.0	2.0	3.0	4.0	2.0	3.0
P8	SPEED	1.0	4.0	4.0	4.0	4.0	3.0	1.0	4.0	4.0	4.0	1.0	3.0	4.0	4.0	2.0	3.0	4.0	4.0	3.0	3.0
P9	SPEED	1.0	2.0	3.0	1.0	2.0	4.0	2.0	1.0	1.0	2.0	1.0	4.0	1.0	2.0	3.0	4.0	2.0	4.0	4.0	3.0
P10	SPEED	1.0	3.0	3.0	4.0	4.0	4.0	3.0	4.0	2.0	4.0	1.0	4.0	4.0	3.0	4.0	4.0	4.0	4.0	4.0	4.0
P11	SPEED	1.0	4.0	4.0	4.0	4.0	4.0	4.0	4.0	3.0	3.0	1.0	2.0	4.0	4.0	4.0	4.0	4.0	4.0	2.0	2.0
P12	SPEED	1.0	4.0	4.0	4.0	2.0	4.0	4.0	4.0	4.0	4.0	1.0	4.0	4.0	4.0	4.0	2.0	4.0	4.0	2.0	2.0

## BATTERY REPLACEMENT

**Step 1:** Remove the insulating sheet before using the remote control.

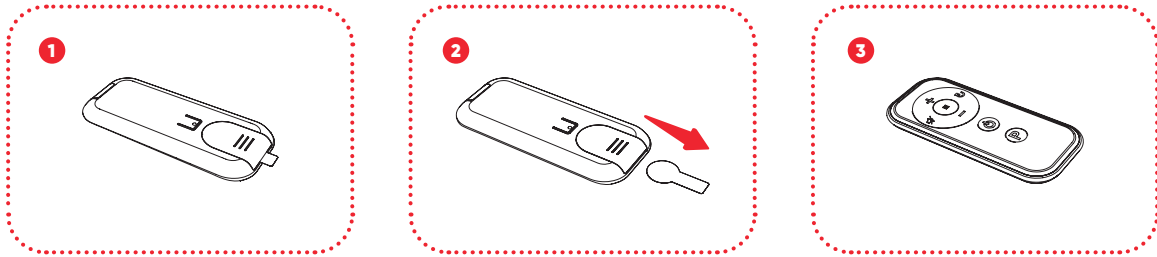

**Step 2:** Remove button cell of remote control:

After long-term use, the remote control will have reduced sensitivity or become inoperable due to insufficient power, and the battery needs to be replaced. Remove battery cover and take dead batteries out of your remote control.

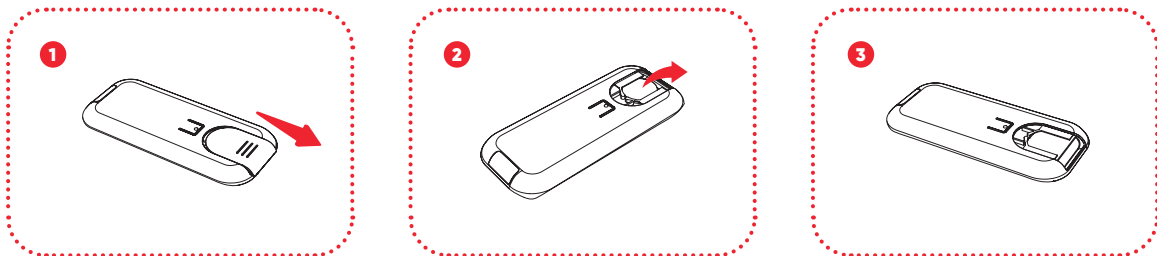

**Step 3:** Install button cell of remote control:

Ensure you have purchased new batteries that are the right type for the remote control by comparing with the dead ones. Insert your new batteries into the remote and replace cover. Dispose of old batteries responsibly.

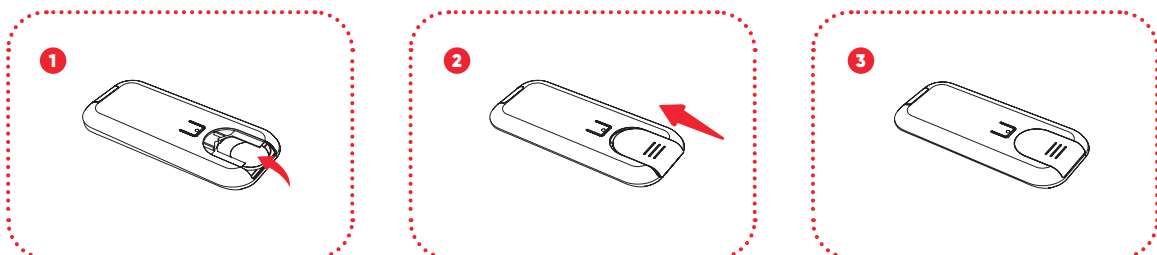

# INSTRUCTIONS FOR USING THE TREADMILL

## PREPARATION BEFORE USE:

1. Plug in the power cord
2. Establish the connection between the treadmill and the remote control
3. Press the power switch on the treadmill and wait for the indicator light to turn on

## INSTRUCTIONS FOR USE

Note: All modes of the treadmill must be started while the machine is in standby. Keep treadmill in standby before switching to a different mode.

Note: In order to extend the life of treadmill, the maximum time for one workout has been set to 99 minutes. The treadmill will stop running should you hit this time and the display screen will read END.

## HOW TO USE THE TREADMILL IN STANDARD MODE

### 1. How to turn on the treadmill

In standby mode, press the Start/Stop button on the remote control and the running belt will begin moving at 0.5km/h in 3 seconds

### 2. How to adjust the treadmill speed

To change the speed of the running belt, press the +/- buttons on the remote control; the speed will be adjusted by 0.1km/h when you press the button. Hold for 0.5 seconds or longer and the speed will increase or decrease continuously.

### 3. How to select the desired display mode

The left screen displays three modes: Time, Step and Calorie. The right screen displays two modes: Speed and Distance. When the treadmill is running, you can select fixed display or cyclic display mode by pressing the M button on the remote control. In cyclic display mode, the display between each option in 5 second intervals.

### 4. How to pause/restart the treadmill

Press Start/Stop button on the remote control while running belt is in motion and the treadmill will slow down slowly and return to pause mode.

In the pause mode, press Start/Stop button on the remote control and the running belt will begin moving at the previous selected program.

### 5. How to turn off the treadmill

When the treadmill is paused, press the Reset button on the remote control and the treadmill will slowly return to standby mode.

## HOW TO USE THE TREADMILL IN PRESET MODE

### 1. How to choose a program

In standby mode, you can select from 12 preset automatic programs (P1-P12) by pressing the P button on the remote control

### 2. How to adjust the time of the preset program

After you have selected a preset program, press the +/- buttons on the remote control to adjust its duration in 1 minute increments. Hold for over 0.5 seconds for timer to roll quickly. The selectable time range is 5-99 minutes.

### 3. How to turn on the treadmill

When you have selected the desired automatic program and duration, press the Start/Stop button on the remote control, and the running belt will begin moving at the preset program speed in 3 seconds

### 4. How to pause/restart the treadmill

Press the Start/Stop button on the remote control while running belt is in motion and the treadmill will slow down slowly and return to pause mode.

In the pause mode, press the Start/Stop button on the remote control and the running belt will begin moving at the previous selected program.

### 5. How to turn off the treadmill

When the treadmill is paused, press the Reset button on the remote control and the treadmill will slowly return to standby mode.

**Note: The speed can't be adjusted when running in preset mode**

## HOW TO USE THE TREADMILL IN CUSTOM MODE

### 1. How to choose a program

In standby mode, you can press the M button on the remote control to select a mode from time, distance and calorie

### 2. How to set the value of the program

**Note: Only one of the three modes can be selected.**

**Time setting:**

In standby mode, press the M button on remote control and adjust time by pressing the +/- buttons to adjust its duration in 1 minute increments. Hold for over 0.5 seconds for timer to roll quickly. The selectable time range is 5-99 minutes.

**Distance setting:**

In standby mode, press the M button on the remote control twice and then adjust the distance by pressing the +/- buttons on the remote control. Hold for more than 0.5 seconds for counter to roll quickly. The selectable distance range is 1-99 kilometer.

**Calorie setting:**

In standby mode, press the M button on the remote control 3 times, and then adjust the number of calories you wish to burn by pressing the +/- buttons. Adjustments made in units of 1 calories. Hold for more than 0.5 seconds for the value to increase or decrease continuously. The selectable calorie burn range is 20-990 calories.



**3. How to turn on the treadmill**

Once you've set up your desired program, press the Start/Stop button on the remote control and the running belt will begin moving at 0.5mph in 3 seconds

**4. How to adjust the treadmill speed**

To change the speed of the running belt, you can press the +/- buttons on the remote control. Pressing the button once will adjust speed by 0.1 km/h; holding the button will allow counter to roll quickly.

**5. How to pause/restart the treadmill**

Press the Start/Stop button on the remote control while running belt is in motion and the treadmill will slow down slowly and return to pause mode.

In the pause mode, press the Start/Stop button on the remote control and the running belt will begin moving at the previous selected program.

**6. How to turn off the treadmill**

When the treadmill is paused, press the Reset button on the remote control and the treadmill will slowly return to standby mode.



## PRODUCT MAINTENANCE

REGULAR MAINTENANCE IS IMPORTANT FOR YOUR SAFETY AND TO EXTEND THE LIFE OF YOUR PRODUCT. PLEASE CHECK AND TIGHTEN ALL PARTS BEFORE YOUR FIRST USE AND REPLACE WORN PARTS OVER TIME AS NEEDED.

### DAILY CLEANING

Clean your treadmill regularly. The running belt and console must be clean and dry for long term safe use. Power off and unplug your treadmill. Wipe the exterior with a damp cloth and a small amount of mild soap. The display console must be kept dry, however; wipe it with a dry, soft towel. Dry the treadmill thoroughly with a soft towel.

**Note: Do not spray liquid directly on the treadmill. To avoid damaging the console, keep it dry at all times.**

## ROUTINE MAINTENANCE

### Use of Silicone Lubricant

The treadmill has been lubricated prior to shipment. Friction between the running belt and the running board will greatly affect the service life and performance of the product, so be sure to lubricate every 3 months or 100 kilometer of use.

The silicone oil bottle is sealed. If you need to use it, unscrew the cap and break the sealing film of the bottle. Gently lift the running belt 2-3 inches to give yourself enough room to apply silicone lubricant to the surface of the running board. Apply the lubricant in 4 - 6 inches strips on both sides of the board, ensuring that none gets into the motor shaft, which can cause the belt to slip.

Start the treadmill and let it run for 3 minutes to distribute the silicone lubricant evenly.

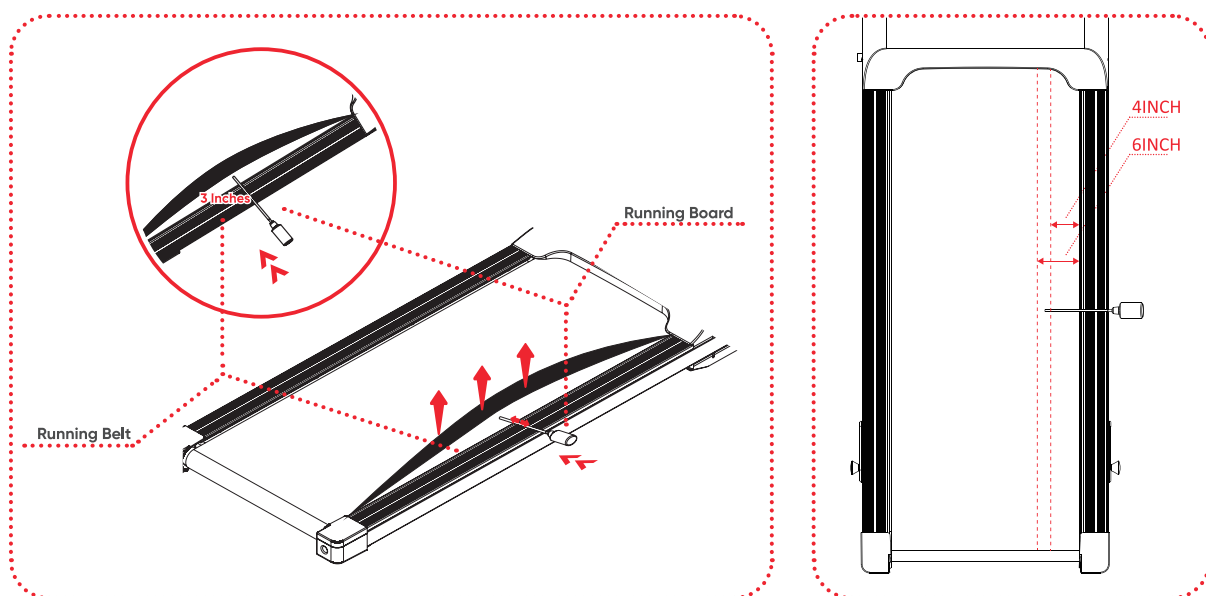

### Running Belt Adjustment

All treadmills are shipped with the running belt adjusted in place of immediate use.

The running belt may deviate from its ideal position over time, which can be caused by the following.

1. The main body is not in kept in a stable position.
2. The user's feet are not in the center of the running belt.
3. The user's feet exert uneven force.

If the deviation is due to issues 2 and 3 above, the treadmill can be returned to normal after 3 minutes of rotation with no weight on the running belt .

If the above does not solve the problem, adjust the running belt with the L-Wrench.

**Running belt is off center**

**Note: Please remove the safety key and unplug the power cord.**

**Running belt shifted to the left**

Use the L-Wrench wrench to turn the left rear roller bolt clockwise 1/4 of a turn to tighten the running belt.

**Running belt shifted to the right**

Use the L-Wrench to turn the right rear roller bolt clockwise 1/4 of a turn to tighten the running belt.

Then plug in the power cord, connect the safety key, and run the treadmill for 3 minutes. Repeat until the running belt is centered.

**Note: use of your treadmill with the running belt out of place can cause preventable wear with the potential for injury.**

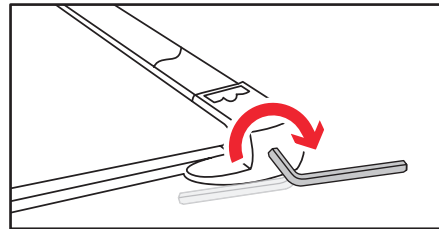
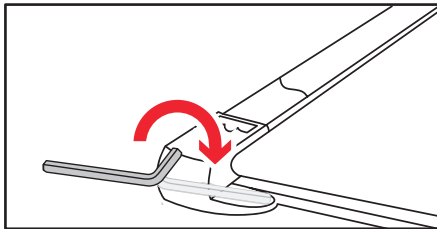
**Running belt is loose**

**Note: Please remove the safety key and unplug the power cord.**

The running belt will loosen over time. A loose running belt will not function properly.

Use the L-Wrench turn both rear idler bolts clockwise 1/4 of a turn to tighten the running belt.

Then plug in the power cord, connect the safety key, run the treadmill for 3 minutes. Repeat until the running belt is centered.

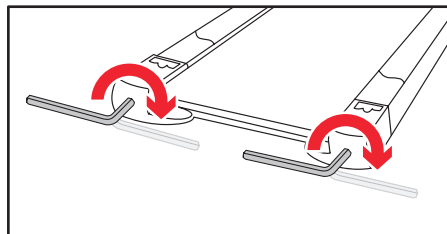

**Note: A running belt that is too tight can cause damage to the belt itself and its rollers. Strange noises are an indication your belt is too tight and must be loosened for a safe experience.**

**Note: Search “REDLIRO” on YouTube to find videos on how to adjust the running belt.**

## TROUBLESHOOTING AND HANDLING

IF YOU ARE EXPERIENCING ISSUES THAT YOU CAN NOT FIND A SOLUTION FOR BELOW, PLEASE CONTACT CUSTOMER SERVICE.

**Issue 1:** your home's electricity is affected by the treadmill being powered on.

- Please check whether the treadmill is plugged into the same circuit as other high-power electrical appliances. If so, please plug into separate circuit.

**Issue 2:** The treadmill does not turn on or turns off automatically.

- Please check whether the outlet you are using is working properly and whether the power cord is damaged.
- Please check whether the power cord of the treadmill is plugged in tightly, and whether the red switch light next to the socket is on.
- Please open the front cover when the power is off, and check that the metal connectors of the connecting wires from the external power supply to the switch, and from the switch to the lower control board (beside the motor) are inserted firmly.

**Issue 3:** The power switch light is on, but the screen displays nothing.

- Please open the front cover when the power is off (do not touch the control board or any line when the power is on). Plug in the power cord and observe whether the power indicator on the lower control board (beside the motor) lights up when the power is turned on.
- If the power indicator of the lower control board is on, please re-insert the connecting wire between the lower control board and the display board when the power is off (the glue on the terminal can be removed by rubbing with an alcohol soaked cotton swab and leaving for 3 minutes before scraping it off.) Check whether the metal contact pins in the terminal are neatly arranged. There are buckles at the terminals and these buckles should not be able to be pulled out of place if you pull lightly. If they move, please insert firmly.

**Issue 4:** "----" is displayed and the treadmill doesn't work.

- Please check whether the safety key has been placed in the designated position.

If the safety key has been placed properly, check whether it has been demagnetized with use of an iron object.

- If the power indicator of the lower control board is on, please re-insert the connecting wire between the lower control board and the display board when the power is off (the glue on the terminal can be removed by rubbing with an alcohol soaked cotton swab and leaving for 3 minutes before scraping it off.) Check whether the metal contact pins in the terminal are neatly arranged. There are buckles at the terminals and these buckles should not be able to be pulled out of place if you pull lightly. If they move, please insert firmly.
- If the problem persists, please contact customer service.

**Issue 5:** The screen display and the safety key are unresponsive.

- Please check whether any button on the console is stuck after being pressed. This can affect other buttons.

**Issue 6:** The step counter is inaccurate.

- If you hold the handrails with both hands, you might have an inaccurate reading should the pressure applied by each hand be different. Hold the handrails using the same force for best results.
- Please confirm whether you are underweight. If so, please contact customer service.

**Issue 7:** The remote control can't be connected to the treadmill.

- There is a transparent insulating plastic sheet above the battery in the remote control when shipped. Please make sure it has been removed before use.
- Your battery may need to be replaced. Please refer to the section on battery replacement.
- After replacing the battery in the remote control (or the remote control itself), it is necessary to pair the remote control with the treadmill. Please refer to the section on pairing your devices.

**Issue 8:** The remote control loses connection during use.

- Replace the battery and pair your devices. If the problem is not solved, please contact customer service with any photographic or video proof of the issue.

**Issue 9:** The treadmill shakes or has poor stability.

- Please ensure all accessories have been included with your purchase and are secured in place.
- Please ensure all accessories you needed to install are secured in place.

**Issue 10:** Wear on the side of the running belt.

- Wear and tear is often caused by an out of place running belt. Please refer to section on realigning your running belt.

**Issue 11:** The running belt obviously slows down or stops working when in use.

- Check whether the speed of the roller is normal. If so, refer to the section on loose running belt. If it does not work normally, please contact customer service.

**Issue 12:** Abnormal noise from the running board.

- Please check whether the running board is damaged
- Please turn the treadmill upside down, and observe whether there is contact between the bottom running board and the square tube on both sides of the fixed metal frame.

**Issue 13:** Abnormal noise under the upper cover of the treadmill.

- Please confirm whether the product is placed on a carpet of more than 0.5inches thick. If so, please move it to the floor or use a treadmill pad.
- Please open the upper cover of the treadmill (make sure it is powered off first), check whether there are foreign objects inside or if there are cables touching the motor runner. If so, please remove the objects or rearrange the cables (for best results, fasten with cable ties).
- Please check whether the motor fixing bolts are tightened. If they are loose, tighten with a tool.
- The motor is damaged if there is a sudden abnormal sound from the motor.

**Issue 14:** Abnormal noise at the front and rear rollers of the treadmill.

- There may be abnormal sound when it is used for the first time. After running for 20 hours, check whether the abnormal sound disappears.
- The roller is damaged if there is a sudden abnormal sound from the roller.

**Issue 15:** Fault code on display.

- E05: Over current protection.

(1) Please confirm whether your weight is within the load bearing range of the product.

(2) Please confirm whether the treadmill is placed on a level ground.

(3) Please confirm whether the running board has been used for too long after lubricating. If so, please refer to the maintenance instructions regarding lubrication and test again.

- E06: Lower control board is damaged.

(1) Please open the upper cover of the motor when the power is off, and check whether the internal wires are damaged (especially the wires on the motor).

(2) To replace the lower control board, please contact customer service.

- E07: Communication failure.

(1) Please check the communication line with plastic terminals at both ends (such as the communication line from the lower control board to the display board) and re-insert with the power off (the glue on the terminal

can be removed by rubbing with an alcohol soaked cotton swab and leaving for 3 minutes before scraping it off.) Check whether the metal contact pins in the terminal are neatly arranged. There are buckles at the terminals and these buckles should not be able to be pulled out of place if you pull lightly. If they move, please insert firmly.

(2) Reset the machine. If the problem persists, please contact customer service to replace the communication line.

- E08: Poor contact of motor power line or motor failure.

(1) If it is a new product, please open the top cover (with the treadmill powered off) and check whether the power cord of the motor is plugged in tightly.

(2) If it is a used product, confirm that there is no problem with the motor power cord and contact customer service.

## WORKOUT GUIDE

THE CORRECT FORM FOR SEVERAL BASIC STRETCHES IS SHOWN AT THE RIGHT.  
MOVE SLOWLY AS YOU STRETCH — NEVER BOUNCE.

### 1. Toe touch stretch

Stand with your knees bent slightly and slowly bend forward from the hips. Relax your back and shoulders and allow your hands to reach your toes as far as possible. Hold for 15 seconds, then relax. Repeat 3 times.

Stretched parts: Hamstrings, back of knees and the back.

### 2. Hamstring stretch

Sit with one leg extended. Bring the sole of the other foot toward you, resting against the inner thigh of your extended leg. Reach for your toes as far as comfortable. Hold for 15 seconds, then relax. Repeat 3 times with each leg.

Stretched parts: Hamstrings, lower back and groin.

### 3. Calf/ tendon stretch

With one leg in front of the other, reach forward and place your hands against the wall. Straighten your back leg, keeping the foot flat on the floor. Bend your front leg, lean forward, and move your hips toward the wall. Hold for 15 seconds, then relax. Repeat 3 times with each leg. To stretch the tendon further, bend your back leg as well.

Stretched parts: Calf, achilles tendon and ankle.

### 4. Quadriceps stretch

With one hand against the wall for balance, reach back and grab one foot with the other hand. Bring your heels as close to your hips as possible. Hold for 15 seconds, then relax. Repeat 3 times with each leg.

Stretched parts: Quadriceps and glutes.

### 5. Inner thigh extension

Sit with the soles of your feet together and knees facing out. Pull your feet as far as possible toward your groin. Hold for 15 seconds, then relax. Repeat 3 times.

Stretched parts: Quadriceps and glutes.

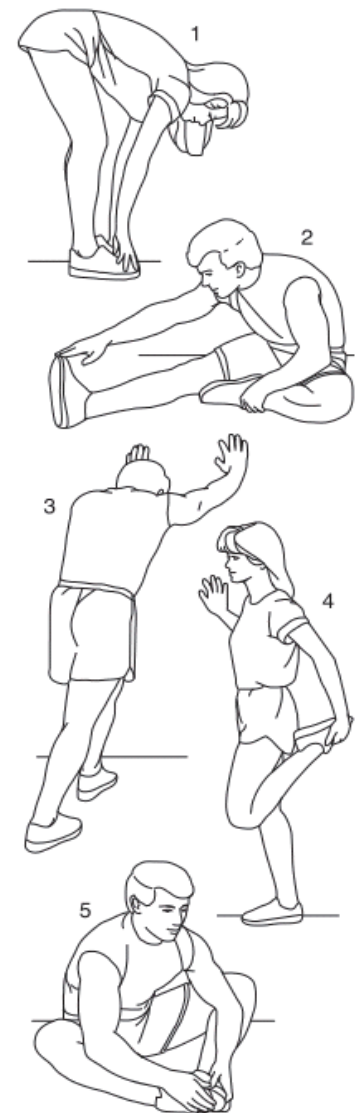



## WARRANTY

### Manufacturer's Limited Warranty

This product is under warranty by Redliro covering manufacturing defects in material and workmanship.

Warranty period of parts

All components are under warranty for 1 year.

Exclusions of warranty:

Warranty does not cover damage due to reasons below:

Improper installation or non-compliance with Redliro's installation guidelines;

1. The product is used for non-household purposes or for purposes other than intended;
2. Surface damage: such as scratches, dents or discoloration;
3. Damage caused by normal wear and tear, vandalism, accident or animals;
4. Any natural disaster (such as fire, flood, snow, ice, hurricane, earthquake, lightning or other natural disasters), environmental conditions (such as air pollution, mold, mildew, etc.) or contamination by foreign substances (such as dirt, grease, oil, etc.);
5. Normal weathering is due to exposure to sunlight, weather and atmosphere, which can cause dust, the accumulation of dirt or stains, and damage from debris.
6. Improper Operation, modification, handling, storage, misuse or neglect of the product.
7. Redliro will, at its sole discretion, repair or replace, any part that proves to be defective in normal household use. Any repairs or replacements will not renew the warranty period. This warranty is provided only to the original purchaser and is non-transferable. Original proof of purchase is required. Replacement parts can be ordered by emailing our customer service department:

### Email for replacement parts:

service@redliro.com

We will respond to your message within 24 hours.

If you need after-sales support, please prepare the following information:

1. Order number
2. Part description (a photo or video will help)
3. Part number
4. Purchase date
5. Recipient's full address and phone number



If you're in need of assistance, don't hesitate to reach out. Our team is available 24/7 and will happily assist with any queries.



Find Turtorial on Redliro YouTube

