

SYSTEM

Ceramica  
VOGUE

TILES FOR ARCHITECTURE

System è un articolato sistema di piastrelle in tinta unita prodotte su supporto di gres smaltato ingelivo di Ceramica Vogue. Ideato oltre 30 anni fa per soddisfare ogni esigenza di progettazione, System si è evoluto costantemente nel tempo divenendo il marchio identificativo dell'azienda sui mercati nazionale e internazionale di settore.

La gamma colori, tra le più estese sul mercato, prevede una nuova palette che risponde alle nuove tendenze e ai nuovi usi per l'arredo di spazi interni ed esterni ad uso pubblico e privato. La conferma dei formati esistenti e l'introduzione di nuove varianti contemporanee montate su rete, consentono a System di essere un importante strumento compositivo al servizio dell'architettura dalle molteplici possibilità di combinazione e di risultato grazie anche alle diverse finiture e ai pezzi speciali disponibili. L'estrema varietà di colori, finiture, formati e pezzi speciali rendono System un sistema altamente versatile per soddisfare impieghi in ambiti molto diversi, dal residenziale al commerciale ma anche nel pubblico come scuole e ospedali, e in tutti quegli ambiti dove siano richieste sia qualità estetiche sia precise caratteristiche tecnico-funzionali.

System comprende al suo interno 4 collezioni:

Interni: definito da un colore pieno e satinato per accentuare l'identità del rivestimento articolato da 34 colori, 9 formati e pezzi speciali a corredo in tutte le cromie.

Trasparenze: caratterizzato dalla finitura lucida in grado di riflettere e "accogliere" al suo interno lo spazio circostante composto da 26 colori, 9 formati e pezzi speciali a corredo in tutti i colori

Flooring & Grip: per un utilizzo specifico a pavimento con caratteristiche antiscivolo (R10 B(A+B) - R11 C (A+B+C)) che comprende 14 colori in 4 formati

Bump: superficie strutturata nel formato 10x20 nata per soddisfare tutte le esigenze legate al mondo piscina e wellness e in generale per tutti gli ambienti con presenza di acqua che necessitano non solo di particolari caratteristiche tecniche ma anche di pezzi speciali a corredo.

System is a complete system of solid-coloured frost-proof glazed porcelain tiles made by Ceramica Vogue. Created more than 30 years ago to respond to all design requirements, System has evolved over the years to become the company's flagship product on the Italian and international ceramic tile markets.

The colour range is one of the most complete on the market, including a new colour palette responding to the latest trends and new uses in interior decorating and outdoor applications for both public and private use.

The traditional sizes have been maintained with the addition of contemporary new versions mounted on mesh backing, making System an important compositional tool for architects, offering a multitude of possible combinations and results thanks to the many different finishes and special pieces available.

The great variety of colours, finishes, sizes and special pieces makes System a highly versatile range of tiles for use in projects of all kinds, from residential projects to commercial spaces and public facilities such as hospitals and schools: all spaces requiring both aesthetic quality and specific technical and functional properties.

System includes four collections:

Interni: defined by solid matt colour which accentuates the identity of the tile, available in 34 colours and 9 sizes, with special pieces available in all colours.

Trasparenze: characterised by a glossy finish that reflects and "welcomes" the space around it within the tile, available in 26 colours, nine sizes and a range of special pieces in all colours

Flooring & Grip: specifically designed for use on the floor, with non-slip properties (R10 B (A+B) - R11 C (A+B+C)), available in 14 colours 4 different sizes

Bump: a textured surface in the 10x20 size, created for swimming pools and wellness facilities and for all places where water is present, requiring not only particular technical features but the special pieces available.

System est un système articulé de carreaux de couleur unis produits sur un support en grès émaillé ingélif de Ceramica Vogue. Conçu il y a plus de 30 ans pour répondre à toutes les exigences de conception, System n'a cessé d'évoluer pour devenir la marque d'identification de l'entreprise sur les marchés national et international du secteur.

La gamme de couleurs, parmi les plus étendues du marché, comprend une nouvelle palette correspondant aux nouvelles tendances et aux nouveaux usages en matière d'ameublement des espaces intérieurs et extérieurs, à usage public ou privé.

La confirmation des formats existants et l'introduction de nouvelles variantes contemporaines montées sur un filet permettent à System d'être un outil de composition important au service d'une architecture offrant de multiples possibilités de combinaison et de résultat grâce notamment aux différentes finitions et pièces spéciales disponibles.

La grande variété de couleurs, finitions, formats et pièces spéciales font de System un système extrêmement versatile pour satisfaire les utilisations dans des domaines très divers, du résidentiel au commercial, mais aussi aux lieux publics, comme les écoles et les hôpitaux, et dans tous les domaines où des qualités esthétiques et des caractéristiques techniques et fonctionnelles précises sont recherchées.

System renferme 4 collections :

Interni: définie par une couleur pleine et satinée pour accentuer l'identité du revêtement articulée en 34 couleurs, 9 formats et des pièces spéciales en complément dans toutes les couleurs.

Trasparenze: caractérisée par une finition brillante capable de refléter et « d'accueillir » l'espace environnant composée de 26 couleurs, 9 formats et de pièces spéciales en complément dans toutes les couleurs.

Flooring & Grip : pour une utilisation spécifique sur le sol avec des caractéristiques antidérapantes (R10 B(A+B) - R11 C (A+B+C)), comprenant 14 couleurs en 4 formats.

Bump : surface structurée au format 10x20 créée pour répondre à toutes les exigences liées au monde des piscines et des centres de bien-être et, plus généralement, à tous les environnements avec présence d'eau nécessitant non seulement de caractéristiques techniques particulières, mais aussi de pièces spéciales en complément.

„System“ ist ein gegliedertes System aus unifarbenen Fliesen, die auf einem Untergrund aus frostbeständigem glasiertem Gres-Steinzeug von Ceramica Vogue hergestellt werden. „System“ wurde vor über 30 Jahren entwickelt, um unterschiedlichsten Planungsansprüchen gerecht zu werden. Im Laufe der Zeit hat es sich kontinuierlich weiterentwickelt und ist zum Erkennungszeichen des Unternehmens geworden, auf dem italienischen Markt ebenso wie auf den internationalen Märkten der Branche. Die Farbpalette ist eine der umfangreichsten auf dem Markt. Ihre Auswahl an Farbtönen wird den neuen Trends und den neuen Einsatzweisen bei der Einrichtung von Innen- und Außenräumen im öffentlichen und privaten Bereich gerecht. Die Bestätigung der vorhandenen Formate und die Einführung moderner neuer Varianten, die auf Netzen montiert werden, lassen „System“ zu einem wichtigen Kompositionswerkzeug im Dienste der Architektur mit unzähligen Möglichkeiten in Bezug auf Kombination und Endergebnis werden. Dies auch dank der verschiedenen Oberflächenausführungen und Formteile, die verfügbar sind. Die extrem hohe Vielfalt an Farben, Oberflächenausführungen, Formaten und Formteilen macht aus „System“ ein höchst vielseitiges System für unterschiedlichste Einsatzbereiche, angefangen bei Wohnbereichen bis hin zu Gewerbeflächen, aber auch für öffentliche Bereiche wie Krankenhäuser und Schulen sowie all jene Bereiche, die sowohl ästhetische Eigenschaften als auch präzise technische und funktionale Eigenschaften erfordern.

„System“ umfasst 4 Kollektionen:

Interni: definiert durch eine satinierte Vollfarbe, welche die Identität der Verkleidung hervorhebt, gegliedert in 34 Farben, 9 Formate und passende Formteile in allen Farbtönen.

Trasparenze: gekennzeichnet durch eine glänzende Oberflächenausführung, die den umliegenden Raum reflektiert und „aufnimmt“, bestehend aus 26 Farben, 9 Formaten und passenden Formteilen in allen Farbtönen.

Flooring & Grip: speziell für den Einsatz für Bodenbeläge, mit rutschhemmenden Eigenschaften (R10 B (A+B) - R11 C (A+B+C)), umfasst 14 Farben in 4 Formaten.

Bump: mit strukturierter Oberfläche, im Format 10x20, wird allen Anforderungen der Welt der Schwimmbecken und des Wellness gerecht, eignet sich im Allgemeinen für alle Nassbereiche, die nicht nur besondere technische Eigenschaften, sondern auch passende Formteile erfordern.

# INDICE/INDEX/INDEX/INDEX

2	Introduzione/Introduction/Introduction/Einführung
9	Galleria immagini/Image gallery/Galerie d'images/Bildergalerie
56	<b>INTERNI</b> Finitura satinata/Matt finishing/Finition satinée/Satinierte Oberfläche
64	<b>TRASPARENZE</b> Finitura lucida/Gloss finishing/Finition brillante/Glänzende Oberfläche
70	<b>FLOORING</b> Superficie antiscivolo satinata/Satin - finish non - slip surface/Surface antidérapante satinée/Rutschhemmende satinierte Oberfläche
74	<b>GRIP</b> Superficie antiscivolo satinata/Satin - finish non - slip surface/Surface antidérapante satinée/Rutschhemmende satinierte Oberfläche
80	<b>MIX</b> Finitura satinata/Matt finishing/Finition satinée/Satinierte Oberfläche Finitura lucida/Gloss finishing/Finition brillante/Glänzende Oberfläche Superficie antiscivolo satinata/Satin - finish non - slip surface/Surface antidérapante satinée/Rutschhemmende satinierte Oberfläche
86	<b>BUMP</b> Superficie antiscivolo strutturata per piscine/Structured non-slip surface for swimming pools/Surface structurée antidérapante pour piscines/Strukturierte rutschfeste Oberfläche für Schwimmbäder
94	Giunto e componibilità dei formati/Modularity and laying/Joint et modularité des formats/Fugen und Zusammenstellbarkeit der Formate
98	Pezzi speciali/Trims/Pièces spéciales/Technische Formstücke
102	Schede tecniche/Technical charts/Fiches techniques/Technische Informationen





Rivestimento/Wall/Revêtement de mur/Wandfliesen:  
TR Seta 5x5 cm  
TR Petrolio 10x10x14 cm  
Giunto/Joint/Joint/Fuge:  
Mapei 131 Vanilla

Pavimento/Floor/Revêtement de sol/Bodenbelag:  
IG Seta 5x5 cm  
IN Petrolio 10x10x14 cm  
Giunto/Joint/Joint/Fuge:  
Mapei 131 Vanilla



Rivestimento/Wall/Revêtement de mur/Wandfliesen:  
TR Azzurro 10x10 cm  
TR Azzurro cod K 2,5x10 cm - cod F 2,5x2,5 cm  
Giunto/Joint/Joint/Fuge:  
Mapei 170 Crocus Blue

Pavimento/Floor/Revêtement de sol/Bodenbelag:  
IN Caffè 20x20 cm  
Giunto/Joint/Joint/Fuge:  
Mapei 136 Mud



Rivestimento/Wall/Revêtement de mur/Wandfliesen:  
TR Mastice 20x40 cm  
TR Mastice 5x40 cm  
Giunto/Joint/Joint/Fuge:  
Mapei 115 River Grey







Rivestimento/Wall/Revêtement de mur/Wandfliesen:  
IN Argento 5x40 cm - 20x40 cm  
Giunto/Joint/Joint/Fuge:  
Mapei 110 Manhattan 2000

Rivestimento/Wall/Revêtement de mur/Wandfliesen:  
IN Laguna 5x20 cm - 5x40 cm - cod. N 2,5x20 cm  
Quadra 2,5x20 cm  
Giunto/Joint/Joint/Fuge:  
Mapei 170 Crocus Blue



Rivestimento/Wall/Revêtement de mur/Wandfliesen:  
TR Tortora 10x20 cm  
TR Cipria 10x20 cm  
Giunto/Joint/Joint/Fuge:  
Mapei 133 Sand

Pavimento/Floor/Revêtement de sol/Bodenbelag:  
IN Malachite 5x5 cm  
Giunto/Joint/Joint/Fuge:  
Kerakoll 49 Muschio



Rivestimento/Wall/Revêtement de mur/Wandfliesen:  
TR Ghiaccio 5x5 cm  
Giunto/Joint/Joint/Fuge:  
Mapei 100 White



Rivestimento/Wall/Revêtement de mur/Wandfliesen:  
IN Latte 20x20 cm - 20x40 cm  
Giunto/Joint/Joint/Fuge:  
Mapei 103 Moon White

Rivestimento/Wall/Revêtement de mur/Wandfliesen:  
TR Senape 5x5 cm - cod. N 2,5x20 cm  
TR Senape cod. K 2,5x10 cm - cod. F 2,5x2,5 cm  
Giunto/Joint/Joint/Fuge:  
Kerakoll 56 Acer

Pavimento/Floor/Revêtement de sol/Bodenbelag:  
IN Argento 20x40 cm  
Giunto/Joint/Joint/Fuge:  
Mapei 110 Manhattan 2000



Rivestimento/Wall/Revêtement de mur/Wandfliesen:  
IN Turchese 10x10 cm  
IN Turchese 10x20 cm  
Giunto/Joint/Joint/Fuge:  
Mapei 171 Turquoise

Rivestimento/Wall/Revêtement de mur/Wandfliesen:  
IN Latte 10x10 cm  
IN Latte Quadra 2,5x20 cm  
Giunto/Joint/Joint/Fuge:  
Mapei 103 Moon White

Pavimento/Floor/Revêtement de sol/Bodenbelag:  
IN Argento 20x40 cm  
Giunto/Joint/Joint/Fuge:  
Mapei 110 Manhattan 2000



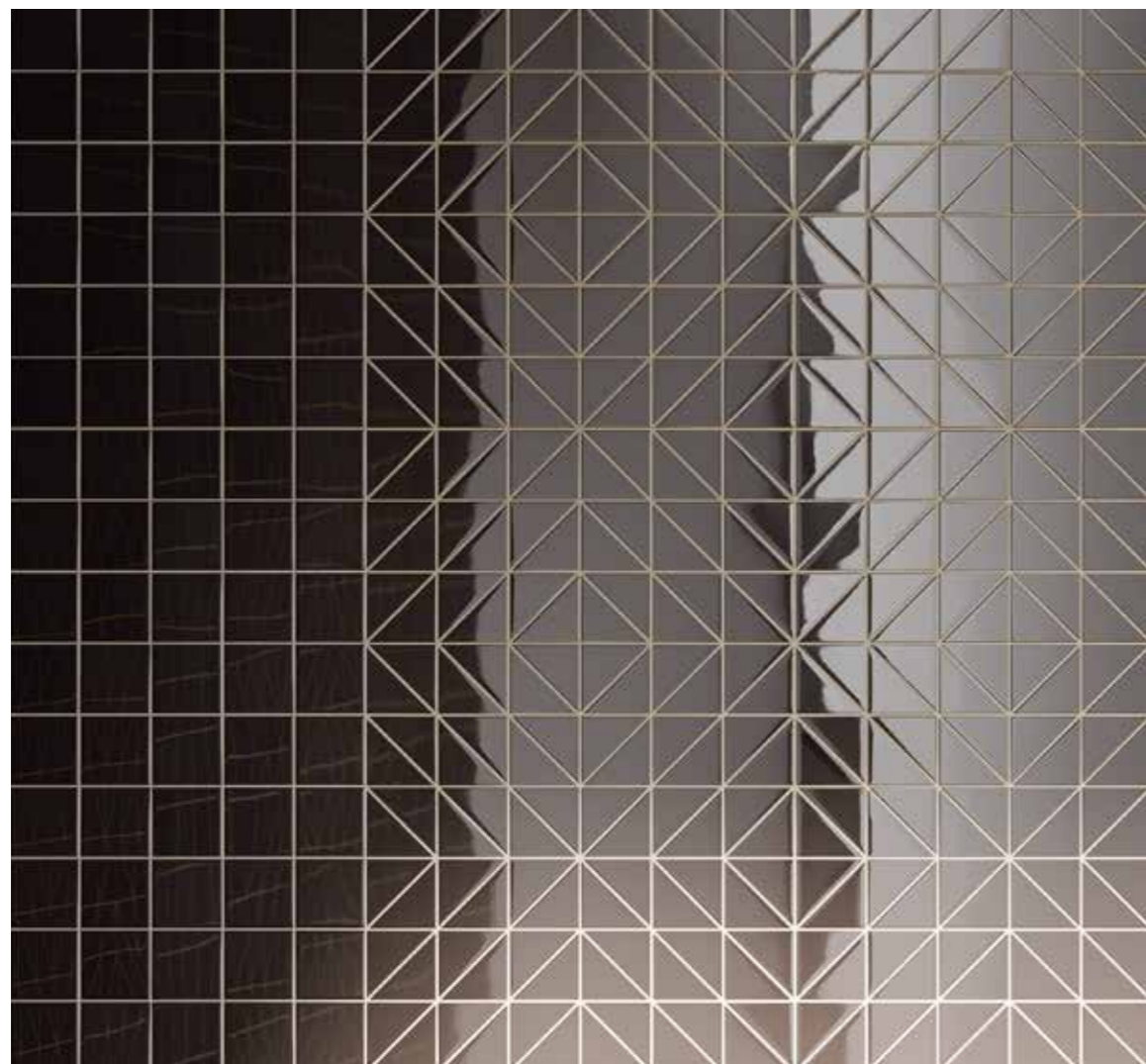

Rivestimento/Wall/Revêtement de mur/Wandfliesen:  
TR Ferro 10x10x14 cm - 10x10 cm  
TR Argento 5x5 cm  
Giunto/Joint/Joint/Fuge:  
Mapei 110 Manhattan 2000







Rivestimento/Wall/Revêtement de mur/Wandfliesen:  
TR Mastice 5x40 cm  
Giunto/Joint/Joint/Fuge:  
Mapei 115 River Grey

Rivestimento/Wall/Revêtement de mur/Wandfliesen:  
TR Malachite 20x40 cm  
Giunto/Joint/Joint/Fuge:  
Kerakoll 49 Muschio



Rivestimento/Wall/Revêtement de mur/Wandfliesen:  
IN Ghiaccio 5x20 cm  
IN Ghiaccio 10x20 cm  
Giunto/Joint/Joint/Fuge:  
Mapei 100 White

Rivestimento/Wall/Revêtement de mur/Wandfliesen:  
IN Ceruleo 5x20 cm - 10x20 cm - 10x10 cm  
IN Ceruleo cod. F 2,5x2,5 cm - cod. K 2,5x10 cm  
Giunto/Joint/Joint/Fuge:  
Mapei 174 Tornado

Pavimento/Floor/Revêtement de sol/Bodenbelag:  
IG Ghiaccio 20x20 cm  
BR Ghiaccio 6,3x20 cm - BP Ghiaccio 10x20 cm  
Giunto/Joint/Joint/Fuge:  
Mapei 100 White



Rivestimento/Wall/Revêtement de mur/Wandfliesen:  
IN Ferro 10x20 cm  
TR Nero 10x20 cm  
Giunto/Joint/Joint/Fuge:  
Mapei 120 Black



Soffitto/Ceiling/Plafond/Decke:  
IN Cipria 10x20 cm - IN Tortora 10x20 cm  
IN Latte 10x20 cm - IN Lilla 10x20 cm  
IN Rosa 10x20 cm  
Giunto/Joint/Joint/Fuge:  
Mapei 133 Sand

Rivestimento/Wall/Revêtement de mur/Wandfliesen:  
TR Laguna 10x10 cm  
Giunto/Joint/Joint/Fuge:  
Kerakoll 49 Muschio





Rivestimento/Wall/Revêtement de mur/Wandfliesen:  
TR Blu Avio 10x10x14 cm  
TR Blu Avio Quadra 2,5x20 cm  
Giunto/Joint/Joint/Fuge:  
Mapei 172 Space Blue

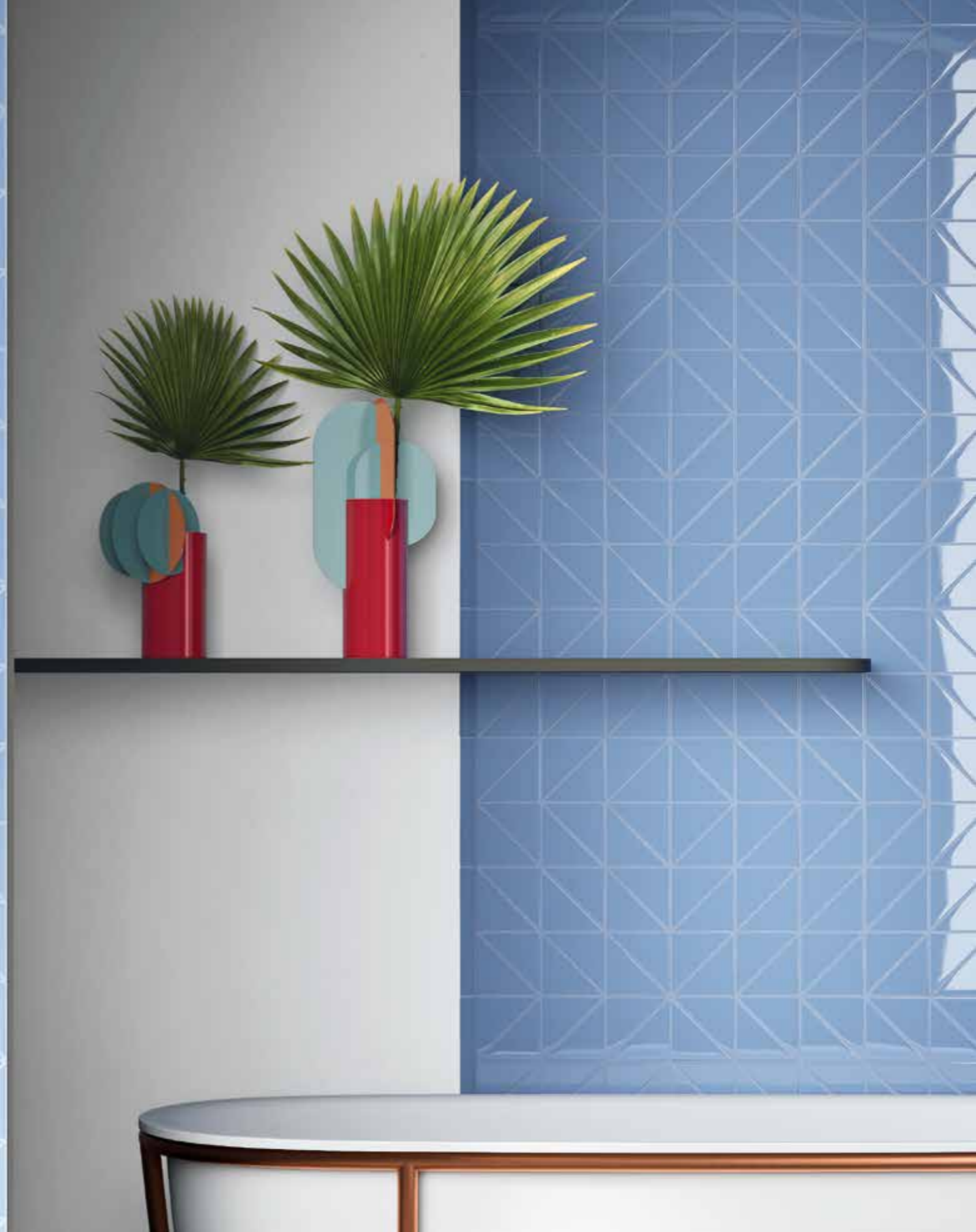

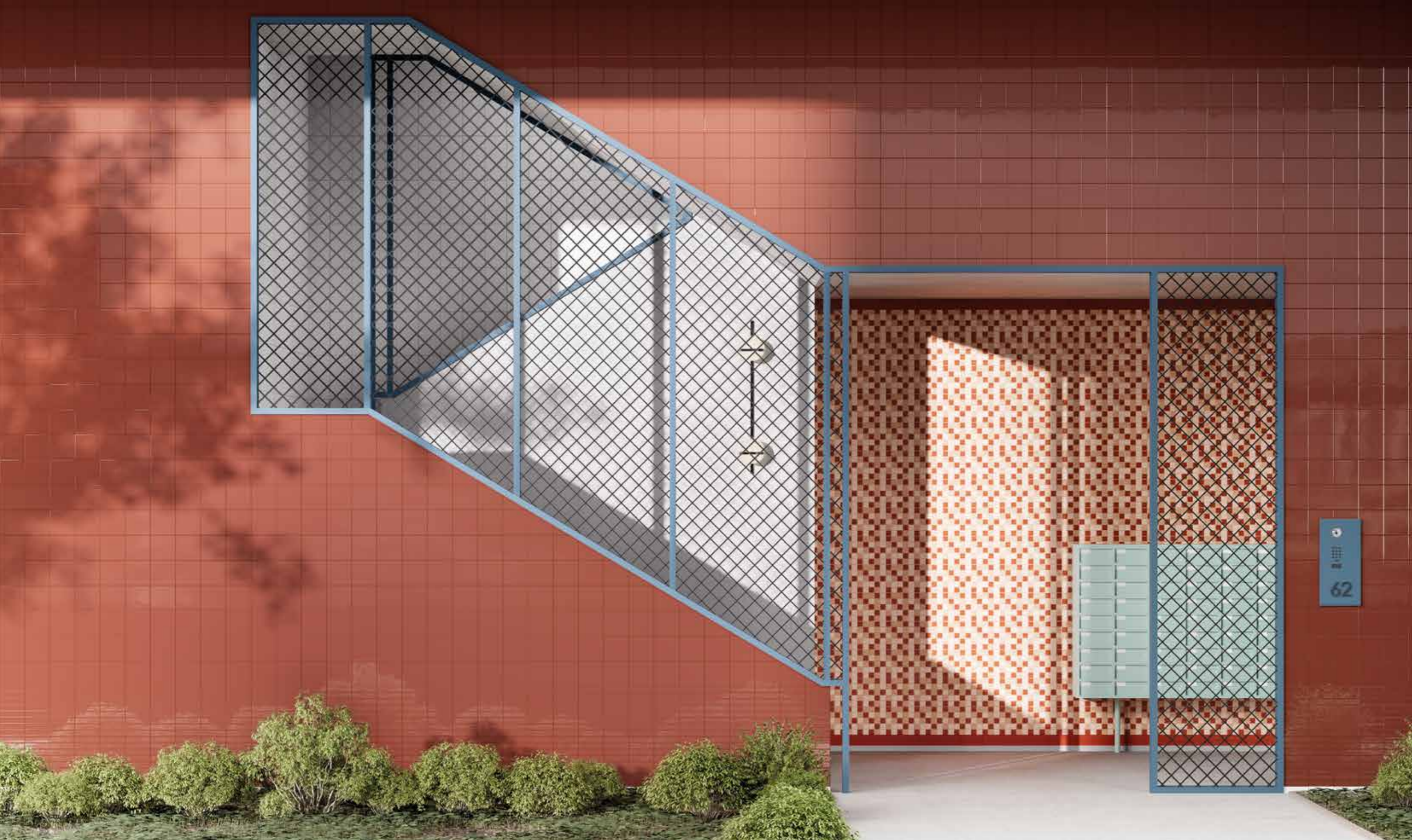

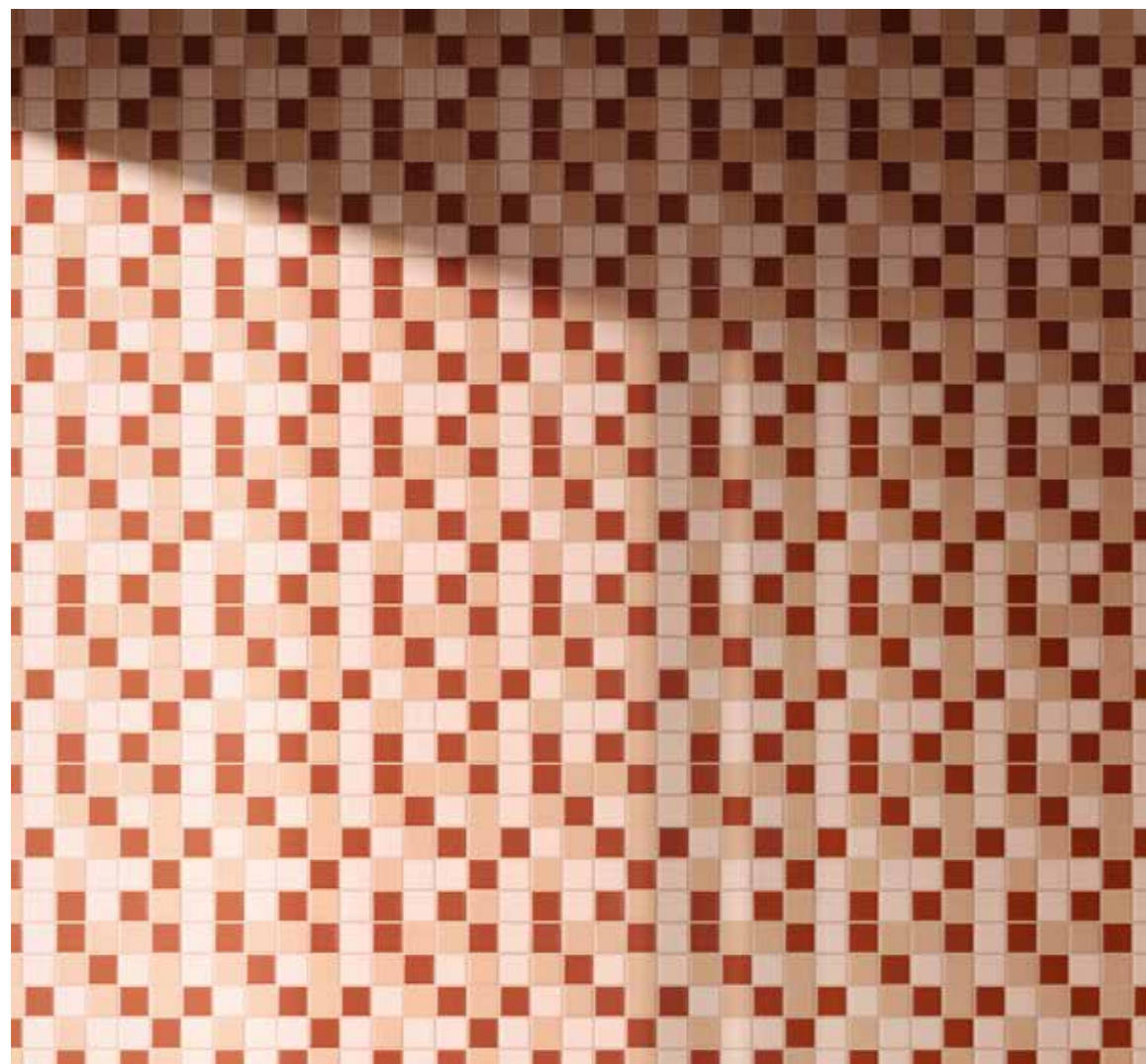

Rivestimento/Wall:  
TR Granata 20x20 cm - 5x20 cm  
IN Lilla 5x20 cm  
MQ RI 004 IN Cipria - IN Mattone - IN Rosa 5x5 cm  
Giunto/Joint:  
Mapei 143 Terracotta  
Mapei 110 Manhattan 2000  
Mapei 132 Beige 2000

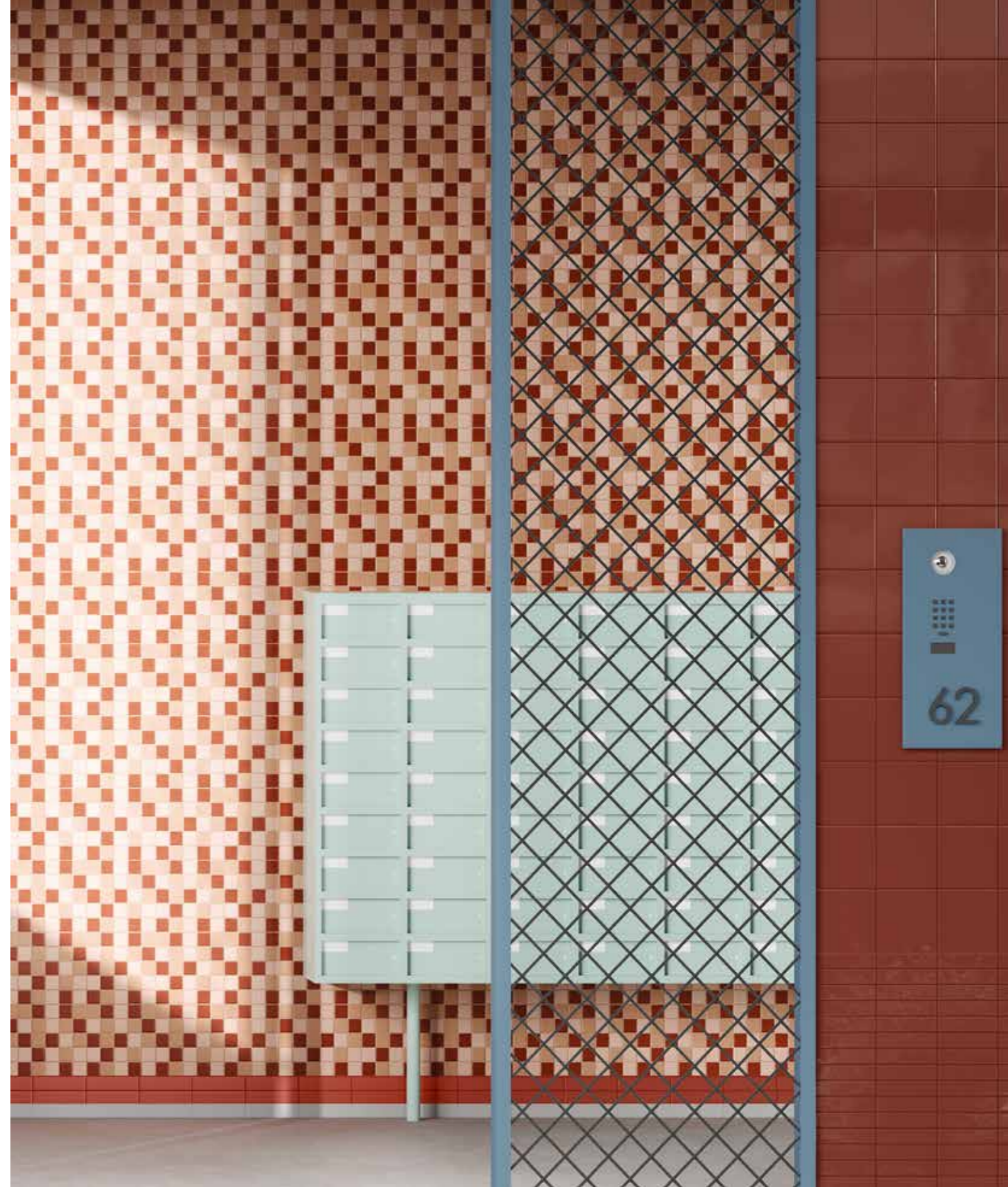



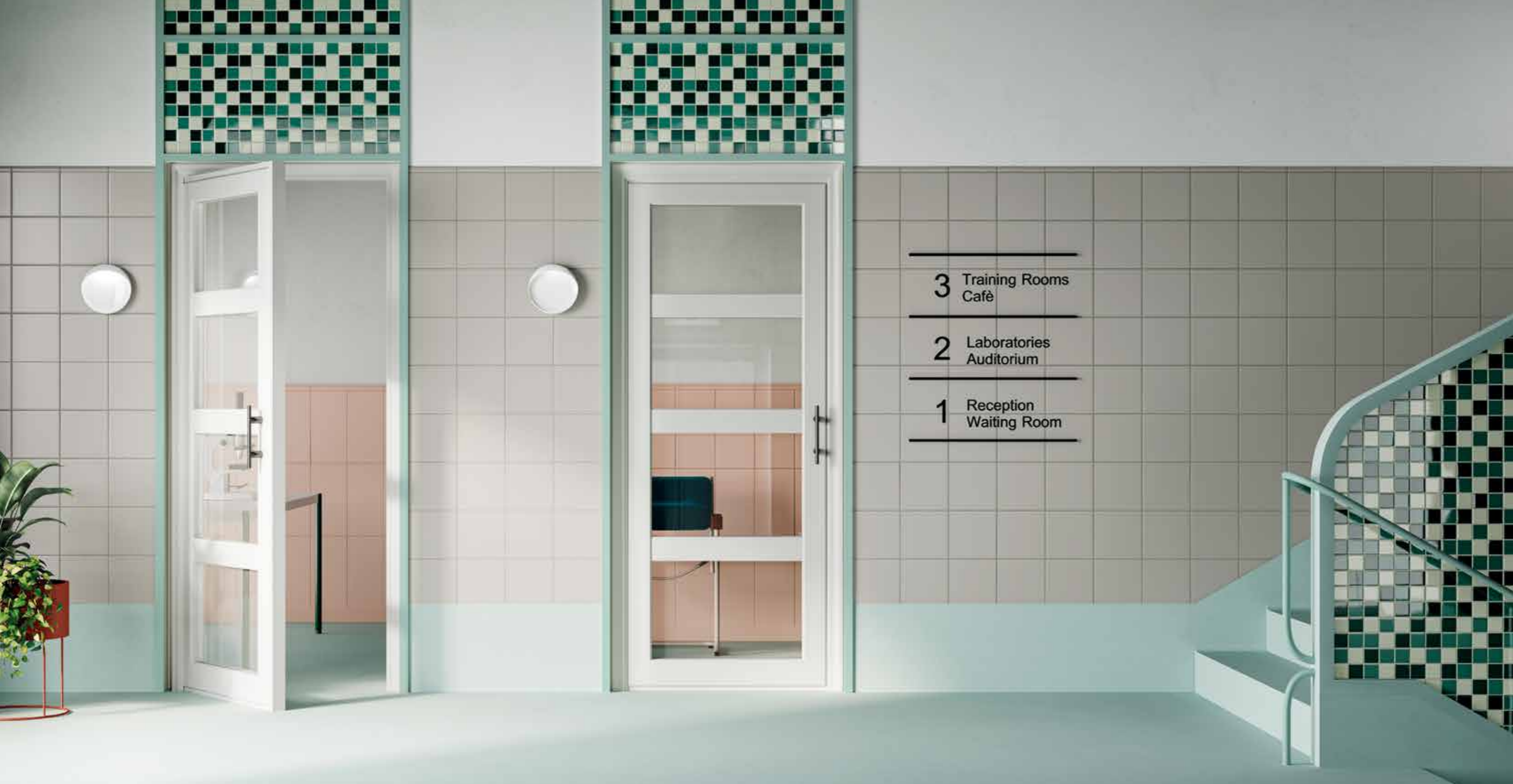

Rivestimento/Wall:  
IN Rosa 20x40 cm  
IN Argento 20x20 cm  
IN Argento Quadra 2,5x20 cm  
Giunto/Joint:  
Mapei 110 Manhattan 2000

Rivestimento/Wall:  
MQ RT 003 TR Mastice - TR Turchese - TR Malachite 5x5 cm  
Giunto/Joint:  
Mapei 115 River Gray





Rivestimento/Wall:  
IN Rosa 10x20 cm  
IN Mastice 5x20 cm - 10x40 cm  
IN Ghiaccio 10x40 cm  
Giunto/Joint:  
Mapei 132 Beige 2000  
Mapei 110 Manhattan 2000  
Mapei 115 River Gray



Rivestimento/Wall:  
TR Ghiaccio 10x40 cm - Quadra 2,5x20 cm  
TR Blu Avio 10x40 cm

Giunto/Joint:  
Mapei 172 Space Blue

Rivestimento/Wall:  
TR Ghiaccio 10x10 cm  
TR Ghiaccio cod K 2,5x10 cm - cod F 2,5x2,5 cm

Giunto/Joint:  
Mapei 100 White

# SYSTEM

## COLORI/FINITURE

COLORS/FINISHINGS

COULEURS/FINITION

FARBEN/OBERFLÄCHENAUSFÜHRUNG

ghiaccio latte seta beige tortora caffè nero ferro grigio argento perla lilla rosa cipria mattone

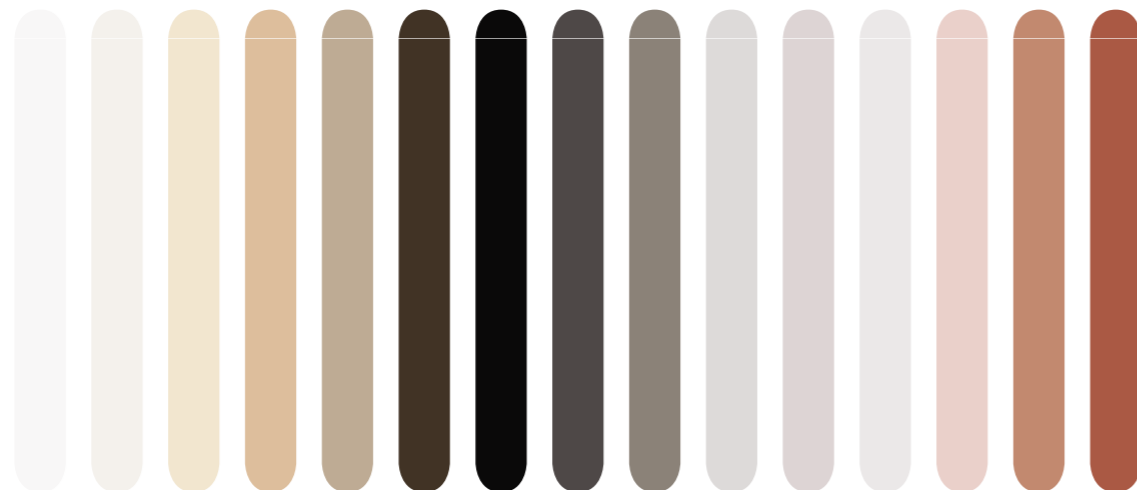

granata rosso mandarino giallo senape cedro pistacchio malachite turchese mastice giada laguna ceruleo petrolio azzurro cielo blu avio cobalto lavanda

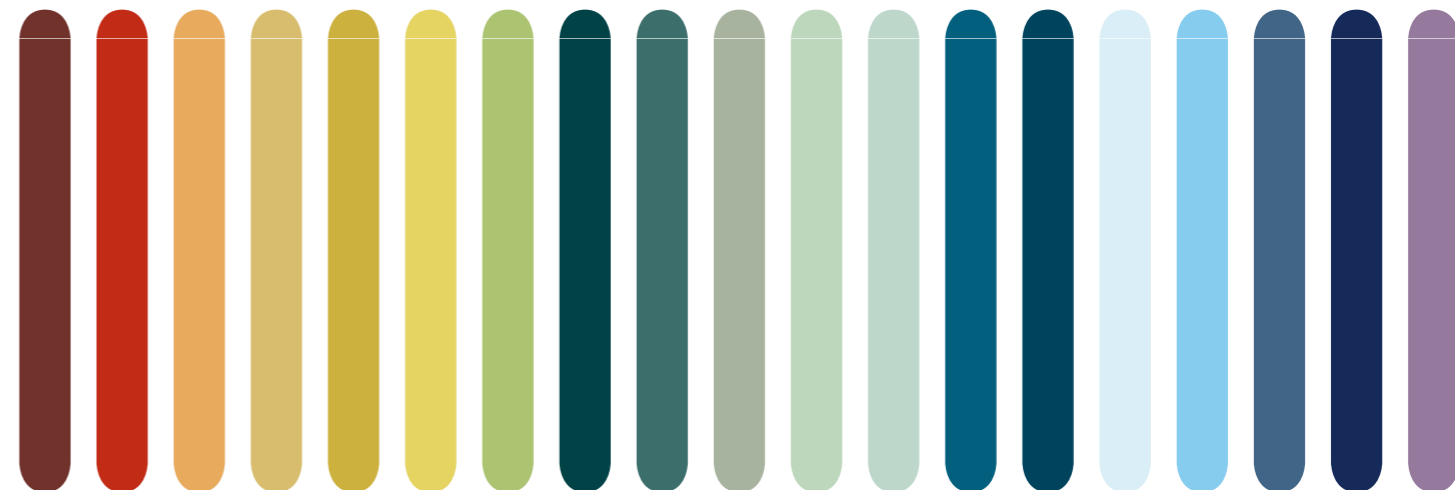

### IN - INTERNI

Finitura satinata/  
Matt finishing  
Finition satinée/  
Satinierter Oberfläche



### TR - TRASPARENZE

Finitura lucida /  
Glossy finishing/  
Finition brillante/  
Glänzende Oberfläche



### RF - FLOORING

Superficie antiscivolo satinata/  
Satin - finish non - slip surface/  
Surface antidérapante satinée/  
Rutschhemmende satinierte Oberfläche

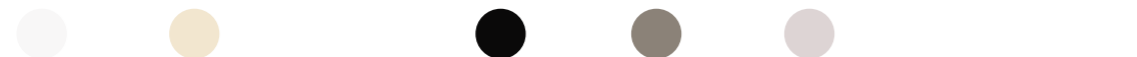

### IG - GRIP

Superficie antiscivolo satinata/  
Satin - finish non - slip surface/  
Surface antidérapante satinée/  
Rutschhemmende satinierte Oberfläche

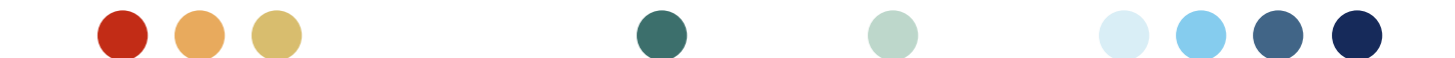
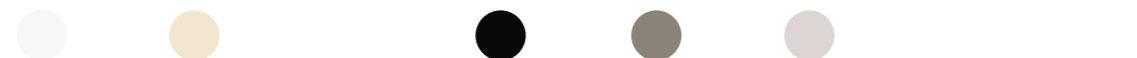



# INTERNI

**FINITURA SATINATA/  
MATT FINISHING/  
FINITION SATINÉE/  
SATINIERTE OBERFLÄCHE**

UTILIZZO: interni ed esterni, pavimenti e rivestimenti  
FINITURA: satinata

USE: internal and external, flooring and covering  
FINISHING: matt

UTILISATION: intérieur et extérieur, sols et murs  
FINITION: satinée

EINSATZ: Innen und Außen, Böden und Wände  
OBERFLÄCHENAUSFÜHRUNG: Satinende

# INTERNI

## FORMATI

FORMATS

FORMATS

FORMATE

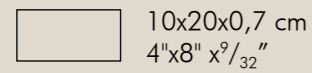

10x20x0,7 cm  
4"x8" x<sup>9</sup>/<sub>32</sub>"



5x5x0,7 cm  
2"x2" x<sup>9</sup>/<sub>32</sub>"

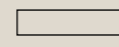

5x20x0,7 cm  
2"x8" x<sup>9</sup>/<sub>32</sub>"



5x40x0,85 cm  
2"x16" x<sup>21</sup>/<sub>64</sub>"

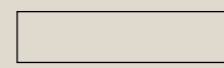

10x40x0,85 cm\*  
4"x16" x<sup>21</sup>/<sub>64</sub>"

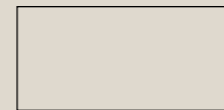

20x40x0,85 cm  
8"x16" x<sup>21</sup>/<sub>64</sub>"



20x20x0,7 cm  
8"x8" x<sup>9</sup>/<sub>32</sub>"



10x10x0,7 cm  
4"x4" x<sup>9</sup>/<sub>32</sub>"



10x10x14x0,7 cm  
4"x4"x5<sup>33</sup>/<sub>64</sub>" x<sup>9</sup>/<sub>32</sub>"



10x10x0,7 cm  
4"x4" x<sup>9</sup>/<sub>32</sub>"

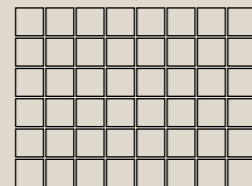

5x5x0,7 cm  
2"x2" x<sup>9</sup>/<sub>32</sub>"

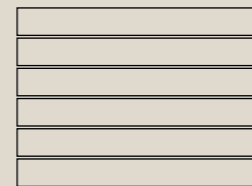

5x40x0,85 cm  
2"x16" x<sup>21</sup>/<sub>64</sub>"

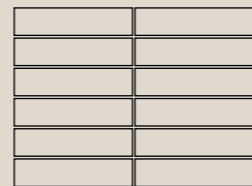

5x20x0,7 cm  
2"x8" x<sup>9</sup>/<sub>32</sub>"

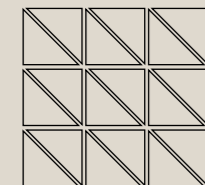

10x10x14x0,7 cm  
4"x4"x5<sup>33</sup>/<sub>64</sub>" x<sup>9</sup>/<sub>32</sub>"

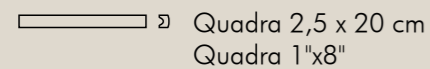

Quadra 2,5 x 20 cm  
Quadra 1"x8"

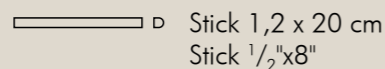

Stick 1,2 x 20 cm  
Stick 1/2"x8"

# INTERNI

## PEZZI SPECIALI

TRIMS

PIÈCES SPÉCIALES

TECHNISCHE FORMSTÜCKE



Cod. M  
2,5x20 cm  
1"x8"



Cod. N  
2,5x20 cm  
1"x8"



Cod. W  
2,5x10 cm  
1"x4"



Cod. K  
2,5x10 cm  
1"x4"



Cod. G  
2,5x10 cm  
1"x4"



Cod. H  
2,5x10 cm  
1"x4"



Cod. F  
2,5x2,5 cm  
1"x1"



Cod. E  
2,5x2,5 cm  
1"x1"



Cod. C  
2,5x2,5 cm  
1"x1"



Cod. D  
2,5x2,5 cm  
1"x1"



Cod. U  
10x10 cm  
4"x4"



Cod. Z  
10x10 cm  
4"x4"

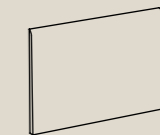

Cod. X  
10x20 cm  
4"x8"

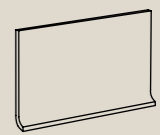

Cod. I  
10x20 cm  
4"x8"

\* Disponibile in: Ghiaccio/Seta/Nero/Perla/Grigio/Cipria/Malachite/Turchese/azzurro/Blu Avio  
Available in: Ghiaccio/Seta/Nero/Perla/Grigio/Cipria/Malachite/Turchese/azzurro/Blu Avio  
Disponibile en: Ghiaccio/Seta/Nero/Perla/Grigio/Cipria/Malachite/Turchese/azzurro/Blu Avio  
Verfügbar in: Ghiaccio/Seta/Nero/Perla/Grigio/Cipria/Malachite/Turchese/azzurro/Blu Avio

**INTERNI**  
**COLORI**  
 COLORS  
 COULEURS  
 FARBEN

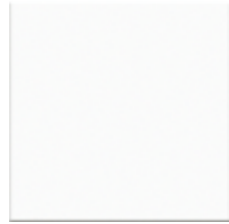

**IN GHIACCIO**  
 RAL 9003 PEI IV

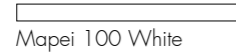

Mapei 100 White

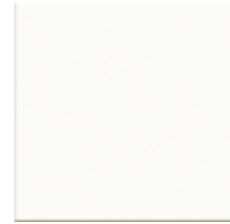

**IN LATTE**  
 RAL 9010 PEI IV



Mapei 103 Moon White



**IN SETA**  
 RAL 1015 PEI IV



Mapei 131 Vanilla



**IN ARGENTO**  
 RAL 7044 PEI III



Mapei 110 Manhattan 2000



**IN PERLA**  
 RAL 7004 PEI IV



Mapei 112 Medium Grey



**IN LILLA**  
 RAL 7047 PEI IV



Mapei 110 Manhattan 2000



**IN BEIGE**  
 RAL 1001 PEI IV



Mapei 138 Almond



**IN TORTORA**  
 RAL 1019 PEI III



Mapei 133 Sand



**IN CAFFE'**  
 RAL 050 20 10 PEI I



Mapei 136 Mud



**IN ROSA**  
 RAL 040 80 10 PEI IV



Mapei 132 Beige 2000



**IN CIPRIA**  
 RAL 050 60 20 PEI III



Mapei 139 Pink Powder



**IN MATTONI**  
 RAL 040 50 40 PEI II



Mapei 145 Terra di Siena

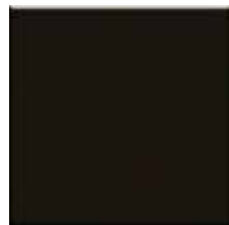

**IN NERO**  
 RAL 9004 PEI I



Mapei 120 Black



**IN FERRO**  
 RAL 8019 PEI II



Mapei 114 Anthracite



**IN GRIGIO**  
 RAL 7006 PEI II



Mapei 134 Silk



**IN GRANATA**  
 RAL 030 30 30 PEI I



Mapei 143 Terracotta



**IN ROSSO**  
 RAL 3020 PEI II



Kerakoll 21 Rosso



**IN MANDARINO**  
 RAL 1034 PEI III



Mapei 139 Pink Powder

GIUNTI  
 JOINTS SUGGESTION  
 JOINTS  
 FUGE

GIUNTI  
 JOINTS SUGGESTION  
 JOINTS  
 FUGE

GIUNTI  
 JOINTS SUGGESTION  
 JOINTS  
 FUGE

GIUNTI  
 JOINTS SUGGESTION  
 JOINTS  
 FUGE

GIUNTI  
 JOINTS SUGGESTION  
 JOINTS  
 FUGE

GIUNTI  
 JOINTS SUGGESTION  
 JOINTS  
 FUGE



**INTERNI**  
**COLORI**  
 COLORS  
 COULEURS  
 FARBEN



**IN GIALLO**  
 RAL 1002 PEI III



Mapei 150 Yellow



**IN SENAPE**  
 RAL 085 70 50 PEI III



Kerakoll 56 Acer



**IN CEDRO**  
 RAL 1018 PEI III



Kerakoll 23 Giallo



**IN CERULEO**  
 RAL 240 40 15 PEI II



Mapei 174 Tornado



**IN PETROLIO**  
 RAL 230 30 20 PEI II



Mapei 174 Tornado



**IN AZZURO**  
 RAL 220 80 10 PEI IV

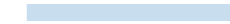

Mapei 170 Crocus Blue



**IN PISTACCHIO**  
 RAL 110 80 30 PEI IV



Mapei 115 River Grey



**IN MALACHITE**  
 RAL 200 30 20 PEI I



Kerakoll 49 Muschio



**IN TURCHESE**  
 RAL 6034 PEI II



Mapei 171 Turquoise



**IN CIELO**  
 RAL 230 70 20 PEI III



Mapei 171 Turquoise



**IN BLU AVIO**  
 RAL 5014 PEI II



Mapei 172 Space Blue



**IN COBALTO**  
 RAL 5022 PEI II



Mapei 174 Tornado



**IN MASTICE**  
 RAL 130 70 10 PEI III



Mapei 115 River Grey



**IN GIADA**  
 RAL 160 80 10 PEI IV



Kerakoll 41 Eucalipto



**IN LAGUNA**  
 RAL 180 80 10 PEI IV



Mapei 170 Crocus Blue



**IN LAVANDA**  
 RAL4009 PEI II



Mapei 162 Violet

GIUNTI  
 JOINTS SUGGESTION  
 JOINTS  
 FUGE

GIUNTI  
 JOINTS SUGGESTION  
 JOINTS  
 FUGE

GIUNTI  
 JOINTS SUGGESTION  
 JOINTS  
 FUGE

GIUNTI  
 JOINTS SUGGESTION  
 JOINTS  
 FUGE

GIUNTI  
 JOINTS SUGGESTION  
 JOINTS  
 FUGE

GIUNTI  
 JOINTS SUGGESTION  
 JOINTS  
 FUGE



# TRASPARENZE

**FINITURA LUCIDA /  
GLOSSY FINISHING/  
FINITION BRILLANTE/  
GLÄNZENDE OBERFLÄCHE**

UTILIZZO: interni ed esterni, rivestimenti  
FINITURA: lucida

USE: internal and external, covering  
FINISHING: glossy

UTILISATION: intérieurs et extérieurs, revêtements  
FINITION: brillante

EINSATZ: Innen-und Außenbereiche, Wandverkleidungen  
OBERFLÄCHENAUSFÜHRUNG: glänzend

# TRASPARENZE

## FORMATI

FORMATS

FORMATS

FORMATE

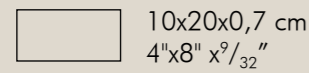

10x20x0,7 cm  
4"x8" x<sup>9</sup>/<sub>32</sub>"



5x5x0,7 cm  
2"x2" x<sup>9</sup>/<sub>32</sub>"

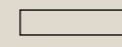

5x20x0,7 cm  
2"x8" x<sup>9</sup>/<sub>32</sub>"

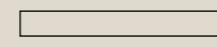

5x40x0,85 cm  
2"x16" x<sup>21</sup>/<sub>64</sub>"

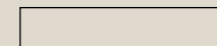

10x40x0,85 cm\*  
4"x16" x<sup>21</sup>/<sub>64</sub>"

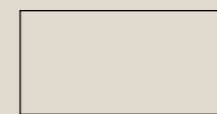

20x40x0,85 cm  
8"x16" x<sup>21</sup>/<sub>64</sub>"



20x20x0,7 cm  
8"x8" x<sup>9</sup>/<sub>32</sub>"



10x10x0,7 cm  
4"x4" x<sup>9</sup>/<sub>32</sub>"



10x10x14x0,7 cm  
4"x4"x5<sup>33</sup>/<sub>64</sub>" x<sup>9</sup>/<sub>32</sub>"



10x10x0,7 cm  
4"x4" x<sup>9</sup>/<sub>32</sub>"



5x5x0,7 cm  
2"x2" x<sup>9</sup>/<sub>32</sub>"

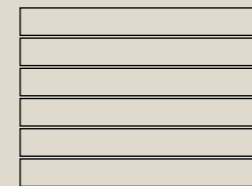

5x40x0,85 cm  
2"x16" x<sup>21</sup>/<sub>64</sub>"

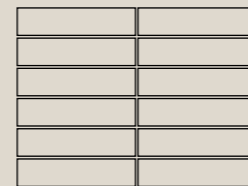

5x20x0,7 cm  
2"x8" x<sup>9</sup>/<sub>32</sub>"

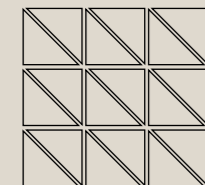

10x10x14x0,7 cm  
4"x4"x5<sup>33</sup>/<sub>64</sub>" x<sup>9</sup>/<sub>32</sub>"

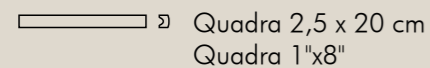

Quadra 2,5 x 20 cm  
Quadra 1"x8"

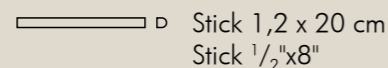

Stick 1,2 x 20 cm  
Stick 1/2"x8"

# TRASPARENZE

## PEZZI SPECIALI

TRIMS

PIÈCES SPÉCIALES

TECHNISCHE FORMSTÜCKE



Cod. M  
2,5x20 cm  
1"x8"



Cod. N  
2,5x20 cm  
1"x8"



Cod. W  
2,5x10 cm  
1"x4"



Cod. K  
2,5x10 cm  
1"x4"



Cod. F  
2,5x2,5 cm  
1"x1"



Cod. E  
2,5x2,5 cm  
1"x1"



Cod. C  
2,5x2,5 cm  
1"x1"



Cod. D  
2,5x2,5 cm  
1"x1"



Cod. U  
10x10 cm  
4"x4"

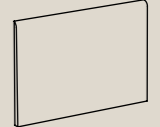

Cod. X  
10x20 cm  
4"x8"

\* Disponibile in: Ghiaccio/Seta/Nero/Perla/Grigio/Cipria/Malachite/Turchese/azzurro/Blu Avio  
Available in: Ghiaccio/Seta/Nero/Perla/Grigio/Cipria/Malachite/Turchese/azzurro/Blu Avio  
Disponibile en: Ghiaccio/Seta/Nero/Perla/Grigio/Cipria/Malachite/Turchese/azzurro/Blu Avio  
Verfügbar in: Ghiaccio/Seta/Nero/Perla/Grigio/Cipria/Malachite/Turchese/azzurro/Blu Avio

# TRASPARENZE

## COLORI

COLORS  
COULEURS  
FARBEN



**TR GHIACCIO** RAL 9003 PEI IV  
**TR TORTORA** RAL 1019 PEI III  
**TR SETA** RAL 1015 PEI III  
**TR NERO** RAL 9004 PEI I



Mapei 100 Bianco Mapei 133 Sand Mapei 131 Vanilla Mapei 120 Black

GIUNTI  
JOINTS SUGGESTION  
JOINTS  
FUGE



**TR FERRO** RAL 8019 PEI I  
**TR GRIGIO** RAL 7006 PEI I  
**TR ARGENTO** RAL 7044 PEI III  
**TR PERLA** RAL 7004 PEI III



Mapei 114 Anthracite Mapei 134 Silk Mapei 110 Manhattan 2000 Mapei 112 Medium Grey

GIUNTI  
JOINTS SUGGESTION  
JOINTS  
FUGE



**TR CIPRIA** RAL 050 60 20 PEI III  
**TR ROSA** RAL 040 80 10 PEI III  
**TR ROSSO** RAL 3020 PEI II  
**TR GRANATA** RAL 030 30 30 PEI I

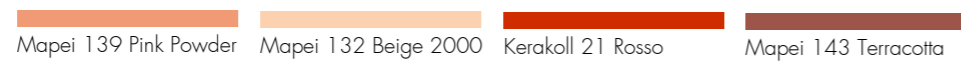

Mapei 139 Pink Powder Mapei 132 Beige 2000 Kerakoll 21 Rosso Mapei 143 Terracotta

GIUNTI  
JOINTS SUGGESTION  
JOINTS  
FUGE



**TR MANDARINO** RAL 1034 PEI II  
**TR GIALLO** RAL 1002 PEI II  
**TR SENAPE** RAL 085 70 50 PEI III  
**TR PISTACCHIO** RAL 110 80 30 PEI III  
**TR MALACHITE** RAL 200 30 20 PEI I



Mapei 139 Pink Powder Mapei 150 Yellow Kerakoll 56 Acer Mapei 115 River Grey Kerakoll 49 Muschio

GIUNTI  
JOINTS SUGGESTION  
JOINTS  
FUGE



**TR TURCHESE** RAL 6034 PEI II  
**TR MASTICE** RAL 130 70 10 PEI III  
**TR LAGUNA** RAL 180 80 10 PEI III  
**TR CERULEO** RAL 240 40 15 PEI II  
**TR PETROLIO** RAL 230 30 20 PEI II



Mapei 171 Turquoise Mapei 115 River Grey Mapei 170 Crocus Blue Mapei 174 Tornado Mapei 174 Tornado

GIUNTI  
JOINTS SUGGESTION  
JOINTS  
FUGE



**TR CIELO** RAL 230 70 20 PEI II  
**TR BLU AVIO** RAL 5014 PEI I  
**TR COBALTO** RAL 5022 PEI I  
**TR AZZURO** RAL 220 80 10 PEI III



Mapei 171 Turquoise Mapei 172 Space Blue Mapei 174 Tornado Mapei 170 Crocus Blue

GIUNTI  
JOINTS SUGGESTION  
JOINTS  
FUGE



# FLOORING

**SUPERFICIE ANTISCIVOLO SATINATA/  
SATIN – FINISH NON – SLIP SURFACE/  
SURFACE ANTIDÉRAPANTE SATINÉE/  
RUTSCHHEMMENDE SATINIERTE OBERFLÄCHE**

UTILIZZO: interni ed esterni, pavimenti umidi - R10 B (A+B)  
FINITURA: satinata

USE: internal and external, damp floors - R10 B (A+B)  
FINISHING: matt

UTILISATION: intérieurs et extérieurs, sols humides - R10 B (A+B)  
FINITION: satinée

EINSATZ: Innen- und Außenbereiche, feuchte Bodenbeläge - R10 B (A+B)  
OBERFLÄCHENAUSFÜHRUNG: satiniert

## FORMATI

FORMATS

FORMATS

FORMATE

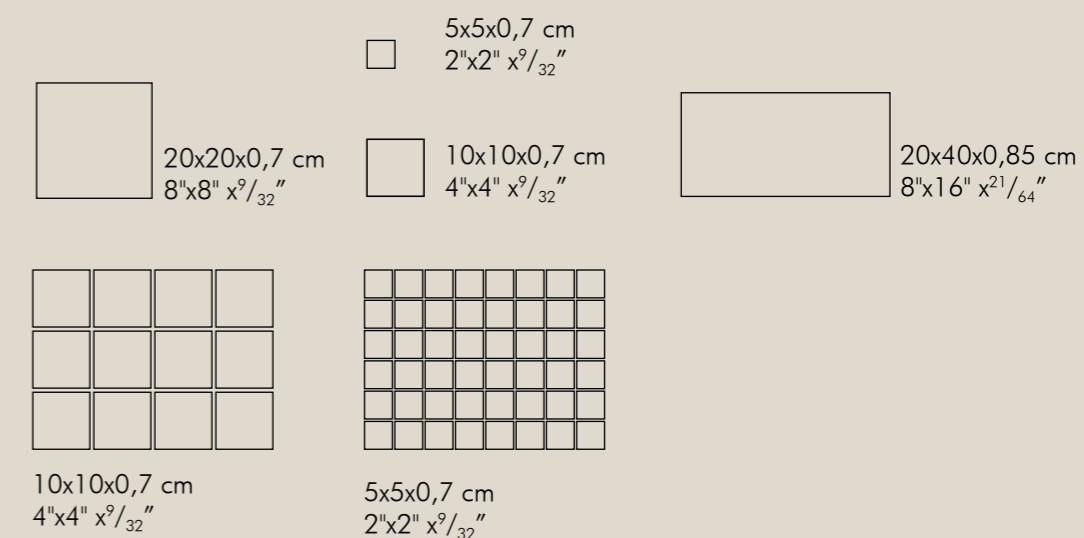

# FLOORING

## COLORI

### COLORS

### COULEURS

### FARBEN



**RF GHIACCIO**  
RAL 9003 PEI IV

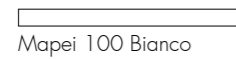

GIUNTI  
JOINTS SUGGESTION  
JOINTS  
FUGE



**RF SETA**  
RAL 1015 PEI IV

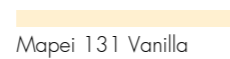

**RF PERLA**  
RAL 7004 PEI IV

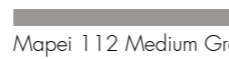

**RF ROSSO**  
RAL 3020 PEI III



**RF MANDARINO**  
RAL 1034 PEI III

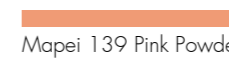

**RF GIALLO**  
RAL 1002 PEI III



GIUNTI  
JOINTS SUGGESTION  
JOINTS  
FUGE



**RF AZZURRO**  
RAL 220 80 10 PEI IV



GIUNTI  
JOINTS SUGGESTION  
JOINTS  
FUGE



**RF CIELO**  
RAL 230 70 20 PEI III

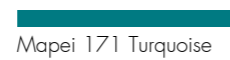

**RF BLU AVIO**  
RAL 5014 PEI III



**RF TURCHESE**  
RAL 6034 PEI II

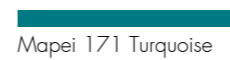

**RF LAGUNA**  
RAL 180 80 10 PEI IV



**RF GRIGIO**  
RAL 7006 PEI III

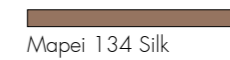

GIUNTI  
JOINTS SUGGESTION  
JOINTS  
FUGE



**RF COBALTO**  
RAL 5022 PEI I



GIUNTI  
JOINTS SUGGESTION  
JOINTS  
FUGE



**RF NERO**  
RAL 9004 PEI I

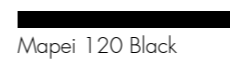

GIUNTI  
JOINTS SUGGESTION  
JOINTS  
FUGE



# GRIP

**SUPERFICIE ANTISCIVOLO SATINATA/  
SATIN – FINISH NON – SLIP SURFACE/  
SURFACE ANTIDÉRAPANTE SATINÉE/  
RUTSCHHEMMENDE SATINIERTE OBERFLÄCHE**

UTILIZZO: interni ed esterni, pavimenti bagnati - R11 C (A +B+C)  
FINITURA: satinata

USE: internal and external, wet floors - R11 C (A +B+C)  
FINISHING: matt

UTILISATION: intérieurs et extérieurs, sols mouillés - R11 C (A +B+C)  
FINITION: satinée

EINSATZ: Innen-und Außenbereiche, nasse Bodenbeläge - R11 C (A + B+C)  
OBERFLÄCHENAUSFÜHRUNG: satiniert

## FORMATI

FORMATS  
FORMATS  
FORMATE

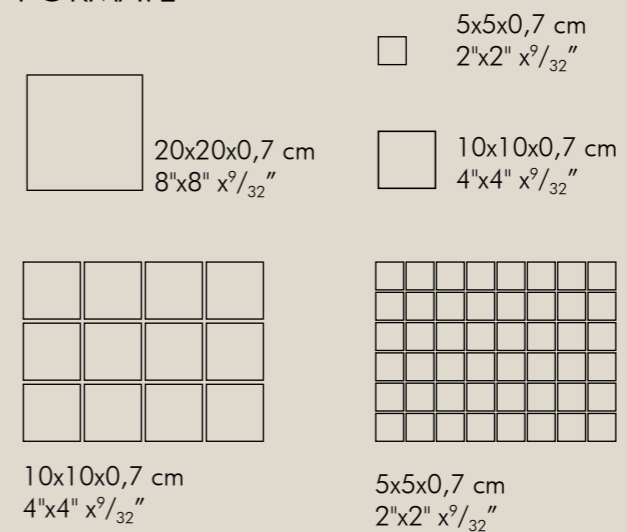

**GRIP**  
**COLORI**  
 COLORS  
 COULEURS  
 FARBEN



**IG GHIACCIO**  
 RAL 9003 PEI IV



Mapei 100 Bianco



**IG SETA**  
 RAL 1015 PEI IV



Mapei 131 Vanilla



**IG PERLA**  
 RAL 7004 PEI IV



Mapei 112 Medium Grey



**IG ROSSO**  
 RAL 3020 PEI III



Kerakoll 21 Rosso



**IG MANDARINO**  
 RAL 1034 PEI III



Mapei 139 Pink Powder



**IG GIALLO**  
 RAL 1002 PEI III



Mapei 150 Yellow



**IG AZZURRO**  
 RAL 220 80 10 PEI IV



Mapei 170 Crocus Blue



**IG CIELO**  
 RAL 230 70 20 PEI III



Mapei 171 Turquoise



**IG BLU AVIO**  
 RAL 5014 PEI III



Mapei 172 Space Blue



**IG TURCHESE**  
 RAL 6034 PEI II



Mapei 171 Turquoise



**IG LAGUNA**  
 RAL 180 80 10 PEI IV



Mapei 170 Crocus Blue



**IG GRIGIO**  
 RAL 7006 PEI III



Mapei 134 Silk



**IG COBALTO**  
 RAL 5022 PEI I



Mapei 174 Tornado



**IG NERO**  
 RAL 9004 PEI I



Mapei 120 Black

GIUNTI  
 JOINTS SUGGESTION  
 JOINTS  
 FUGE

GIUNTI  
 JOINTS SUGGESTION  
 JOINTS  
 FUGE

GIUNTI  
 JOINTS SUGGESTION  
 JOINTS  
 FUGE

GIUNTI  
 JOINTS SUGGESTION  
 JOINTS  
 FUGE

GIUNTI  
 JOINTS SUGGESTION  
 JOINTS  
 FUGE

GIUNTI  
 JOINTS SUGGESTION  
 JOINTS  
 FUGE





**GRIP**  
**PEZZI SPECIALI**  
 TRIMS  
 PIÈCES SPÉCIALES  
 TECHNISCHE FORMSTÜCKE

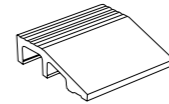

Bordo Cod. B  
 10x10 cm  
 4"x4"

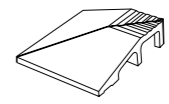

Angolo Cod. I  
 10x10 cm  
 4"x4"

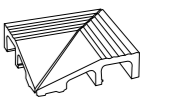

Spigolo Cod. E  
 10x10 cm  
 4"x4"

**COLORI**  
 COLORS  
 COULEURS  
 FARBEN

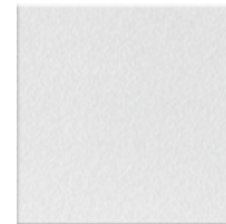

**IG GHIACCIO**  
 RAL 9003 PEI IV

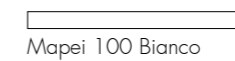

Mapei 100 Bianco



**IG COBALTO**  
 RAL 5022 PEI I



Mapei 174 Tornado

GIUNTI  
 JOINTS SUGGESTION  
 JOINTS  
 FUGE



# MIX

## INTERNI

FINITURA SATINATA/  
MATT FINISHING/  
FINITION SATINÉE/  
SATINIERTE OBERFLÄCHE

## TRASPARENZE

FINITURA LUCIDA /  
GLOSSY FINISHING/  
FINITION BRILLANTE/  
GLÄNZENDE OBERFLÄCHE

**FLOORING** R10 B(A+B)

**GRIP** R11 C(A+B+C)

SUPERFICIE ANTISCIVOLO SATINATA/  
SATIN – FINISH NON – SLIP SURFACE/  
SURFACE ANTIDÉRAPANTE SATINÉE/  
RUTSCHHEMMENDE SATINIERTE OBERFLÄCHE

## FORMATI

FORMATS  
FORMATS  
FORMATE

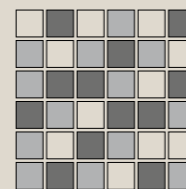

5x5x0,7 cm  
2"x2" x<sup>o</sup>/<sub>32</sub>"

# INTERNI MIX

COLORI  
COLORS  
COULEURS  
FARBEN

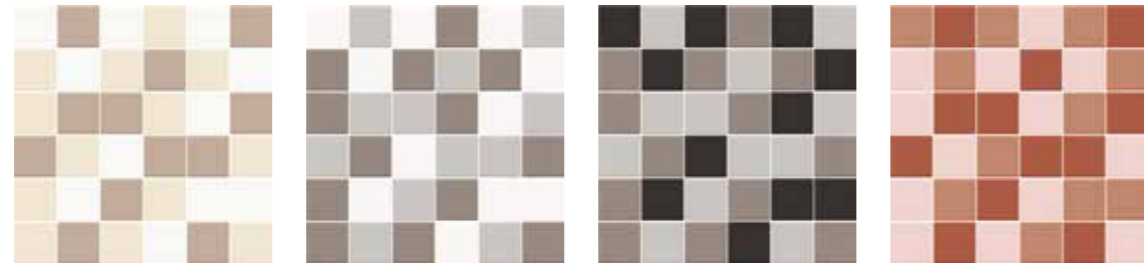

## MQ RI 001

IN LATTE 33%  
IN TORTORA 33%  
IN SETA 33%

Mapei 103 Moon White  
Mapei 133 Sand  
Mapei 131 Vanilla

## MQ RI 002

IN GHIACCIO 33%  
IN ARGENTO 33%  
IN GRIGIO 33%

Mapei 100 White  
Mapei 110 Manhattan 2000  
Mapei 134 Silk

## MQ RI 003

IN FERRO 33%  
IN ARGENTO 33%  
IN GRIGIO 33%

Mapei 100 White  
Mapei 110 Manhattan 2000  
Mapei 114 Anthracite

## MQ RI 004

IN CIPRIA 33%  
IN MATTONE 33%  
IN ROSA 33%

Mapei 139 Pink Powder  
Mapei 145 Terra di Siena  
Mapei 132 Beige 2000

GIUNTI  
JOINTS SUGGESTION  
JOINTS  
FUGE

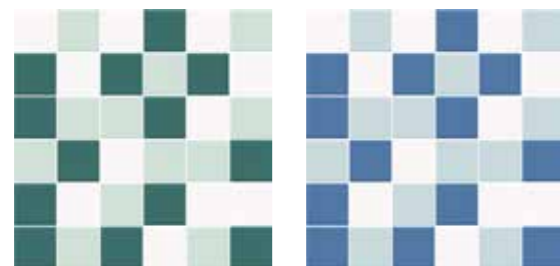

## MQ RI 005

IN GHIACCIO 33%  
IN TURCHESE 33%  
IN LAGUNA 33%

Mapei 100 White  
Mapei 171 Turquoise  
Mapei 170 Crocus Blue

## MQ RI 006

IN GHIACCIO 33%  
IN AZZURRO 33%  
IN BLU AVIO 33%

Mapei 100 White  
Mapei 170 Crocus Blue  
Mapei 172 Space Blue

GIUNTI  
JOINTS SUGGESTION  
JOINTS  
FUGE

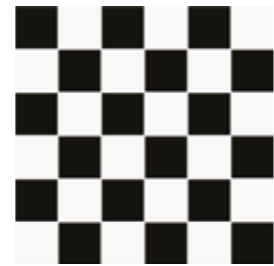

## MQ D4 001

IN GHIACCIO  
IN NERO

Mapei 100 White  
Mapei 120 Black

GIUNTI  
JOINTS SUGGESTION  
JOINTS  
FUGE

# TRASPARENZE MIX

COLORI  
COLORS  
COULEURS  
FARBEN

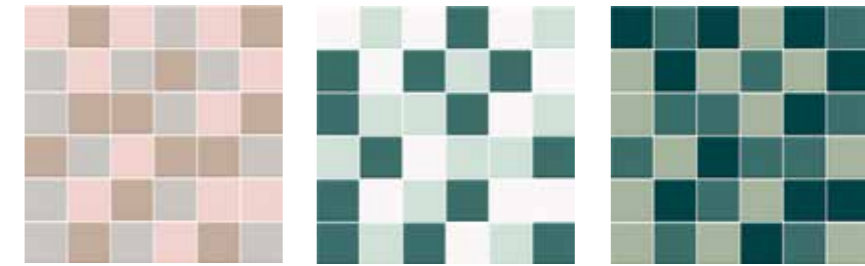

## MQ RT 001

TR ROSA 33%  
TR TORTORA 33%  
TR ARGENTO 33%

Mapei 132 Beige 2000  
Mapei 133 Sand  
Mapei 110 Manhattan 2000

## MQ RT 002

TR GHIACCIO 33%  
TR TURCHESE 33%  
TR LAGUNA 33%

Mapei 100 White  
Mapei 171 Turquoise  
Mapei 170 Crocus Blue

## MQ RT 003

TR MASTICE 33%  
TR TURCHESE 33%  
TR MALCHITE 33%

Kerakoll 49 Muschio  
Mapei 171 Turquoise  
Mapei 115 River Grey

GIUNTI  
JOINTS SUGGESTION  
JOINTS  
FUGE

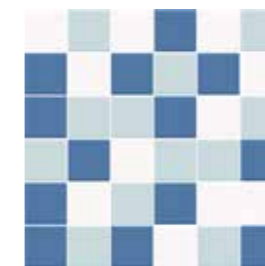

## MQ RT 004

TR GHIACCIO 33%  
TR AZZURRO 33%  
TR BLU AVIO 33%

Mapei 100 White  
Mapei 170 Crocus Blue  
Mapei 172 Space Blue

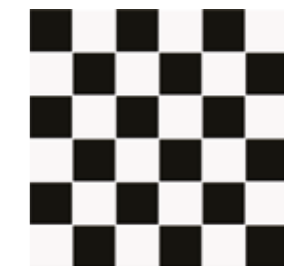

## MQ D4 002

TR GHIACCIO  
TR NERO

Mapei 100 White  
Mapei 120 Black

GIUNTI  
JOINTS SUGGESTION  
JOINTS  
FUGE

# FLOORING MIX R10 B(A+B)

COLORI  
COLORS  
COULEURS  
FARBEN

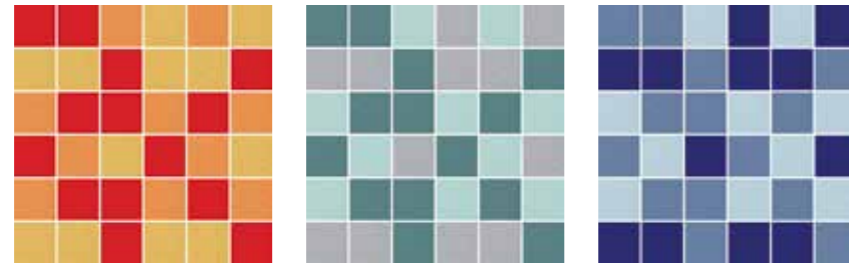

## M RF 01

RF MANDARINO 33%  
RF GIALLO 33%  
RF ROSSO 33%

GIUNTI  
JOINTS SUGGESTION  
JOINTS  
FUGE

Mapei 139 Pink Powder  
Mapei 150 Yellow  
Kerakoll 21 Rosso

## M RF 02

RF TURCHESE 33%  
RF LAGUNA 33%  
RF PERLA 33%

Mapei 171 Turquoise  
Mapei 170 Crocus Blue  
Mapei 112 Medium Grey

## M RF 03

RF AZZURRO 33%  
RF BLU AVIO 33%  
RF COBALTO 33%

Mapei 170 Crocus Blue  
Mapei 172 Space Blue  
Mapei 174 Tornado

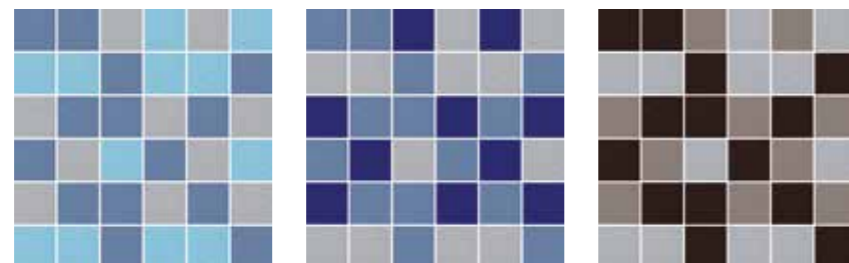

## M RF 04

RF CIELO 33%  
RF BLU AVIO 33%  
RF PERLA 33%

Mapei 171 Turquoise  
Mapei 172 Space Blue  
Mapei 112 Medium Grey

## M RF 05

RF BLU AVIO 33%  
RF COBALTO 33%  
RF PERLA 33%

Mapei 172 Space Blue  
Mapei 174 Tornado  
Mapei 112 Medium Grey

## M RF 06

RF PERLA 33%  
RF GRIGIO 33%  
RF NERO 33%

Mapei 112 Medium Grey  
Mapei 134 Silk  
Mapei 120 Black

# GRIP MIX R11 C(A+B+C)

COLORI  
COLORS  
COULEURS  
FARBEN

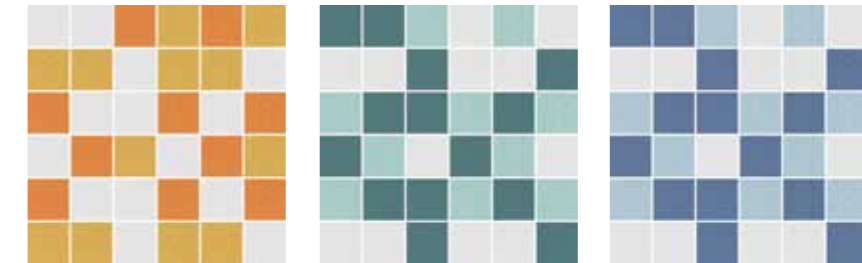

## M IG 01

RF GHIACCIO 33%  
RF MANDARINO 33%  
RF GIALLO 33%

Mapei 100 Bianco  
Mapei 139 Pink Powder  
Mapei 150 Yellow

## M IG 02

RF GHIACCIO 33%  
RF TURCHESE 33%  
RF LAGUNA 33%

Mapei 100 Bianco  
Mapei 171 Turquoise  
Mapei 170 Crocus Blue

## M IG 03

RF GHIACCIO 33%  
RF AZZURRO 33%  
RF BLU AVIO 33%

Mapei 100 Bianco  
Mapei 170 Crocus Blue  
Mapei 172 Space Blue

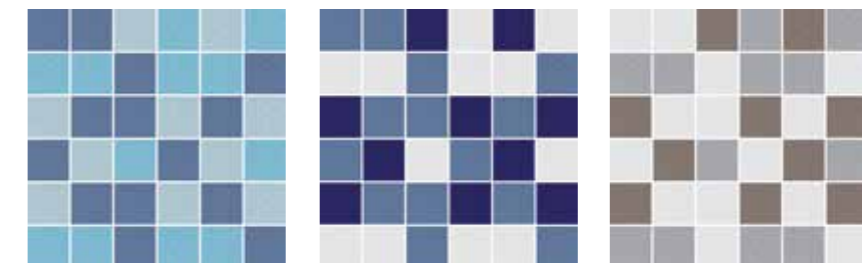

## M IG 04

RF AZZURRO 33%  
RF CIELO 33%  
RF BLU AVIO 33%

Mapei 170 Crocus Blue  
Mapei 171 Turquoise  
Mapei 172 Space Blue

## M IG 05

RF GHIACCIO 33%  
RF BLU AVIO 33%  
RF COBALTO 33%

Mapei 100 Bianco  
Mapei 172 Space Blue  
Mapei 174 Tornado

## M IG 06

RF GHIACCIO 33%  
RF PERLA 33%  
RF GRIGIO 33%

Mapei 100 Bianco  
Mapei 112 Medium Grey  
Mapei 134 Silk

GIUNTI  
JOINTS SUGGESTION  
JOINTS  
FUGE

GIUNTI  
JOINTS SUGGESTION  
JOINTS  
FUGE

GIUNTI  
JOINTS SUGGESTION  
JOINTS  
FUGE

GIUNTI  
JOINTS SUGGESTION  
JOINTS  
FUGE



# BUMP

**SUPERFICIE ANTISCIVOLO STRUTTURATA  
PER PISCINE/  
STRUCTURED NON-SLIP SURFACE FOR  
SWIMMING POOLS/  
SURFACE STRUCTURÉE ANTIDÉRAPANTE POUR  
PISCINES/  
STRUKTURIERTE RUTSCHFESTE OBERFLÄCHE FÜR  
SCHWIMMBÄDER**

UTILIZZO: interni ed esterni, pavimenti - C (A+B+C) V6

FINITURA: opaca

USE: internal and external, floors - C (A+B+C) V6

FINISHING: matt

UTILISATION: intérieurs et extérieurs, sols - C (A+B+C) V6

FINITION: satinée

EINSATZ: Innen- und Außenbereiche, Bodenbeläge - C (A+B+C) V6

OBERFLÄCHENAUSFÜHRUNG: satiniert

## BUMP

### FORMATI

FORMATS

FORMATS

FORMATE

10x20x0,7 cm  
4"x8" x<sup>9</sup>/<sub>32</sub>"

**BUMP**  
**COLORI**  
 COLORS  
 COULEURS  
 FARBEN



**BP GHIACCIO**  
 RAL 9003



Mapei 100 Bianco

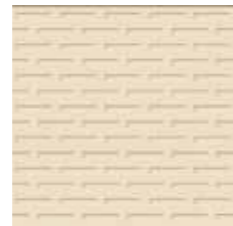

**BP SETA**  
 RAL 1015



Mapei 131 Vanilla



**BP COBALTO**  
 RAL 5022



Mapei 174 Tornado

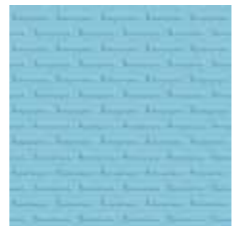

**BP CIELO**  
 RAL 230 70 20

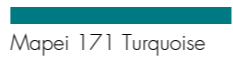

Mapei 171 Turquoise



**BP TURCHESE**  
 RAL 6034



Mapei 171 Turquoise



**BP LAGUNA**  
 RAL 180 80 10



Mapei 170 Crocus Blue



**BP GRIGIO**  
 RAL 7006



Mapei 134 Silk



**BP NERO**  
 RAL 9004



Mapei 120 Black

GIUNTI  
 JOINTS SUGGESTION  
 JOINTS  
 FUGE

GIUNTI  
 JOINTS SUGGESTION  
 JOINTS  
 FUGE

**BUMP PEZZI SPECIALI**  
**COLORI**  
 COLORS  
 COULEURS  
 FARBEN



**FU GHIACCIO**  
 RAL 9003

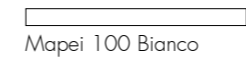

Mapei 100 Bianco



**FU NERO**  
 RAL 9004



Mapei 120 Black



**FU COBALTO**  
 RAL 5022

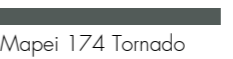

Mapei 174 Tornado



**FU TURCHESE**  
 RAL 6034

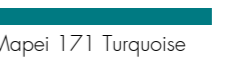

Mapei 171 Turquoise



**BR GHIACCIO**  
 RAL 9003

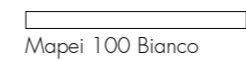

Mapei 100 Bianco



**BR NERO**  
 RAL 9004



Mapei 120 Black



**BR COBALTO**  
 RAL 5022



Mapei 174 Tornado



**BR TURCHESE**  
 RAL 6034

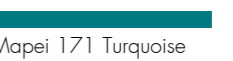

Mapei 171 Turquoise



**BC GHIACCIO**  
 RAL 9003

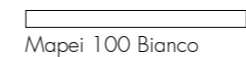

Mapei 100 Bianco

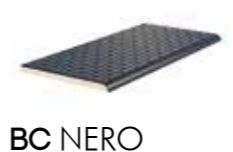

**BC NERO**  
 RAL 9004



Mapei 120 Black



**BC COBALTO**  
 RAL 5022



Mapei 174 Tornado



**BC TURCHESE**  
 RAL 6034



Mapei 171 Turquoise

GIUNTI  
 JOINTS SUGGESTION  
 JOINTS  
 FUGE

GIUNTI  
 JOINTS SUGGESTION  
 JOINTS  
 FUGE

GIUNTI  
 JOINTS SUGGESTION  
 JOINTS  
 FUGE



10x10x0,7 cm  
 4"x4" x<sup>9</sup>/<sub>32</sub>"



6,3x10x2 cm  
 2<sup>1</sup>/<sub>2</sub>"x4" x<sup>25</sup>/<sub>32</sub>"

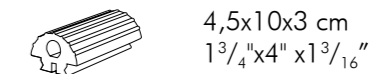

4,5x10x3 cm  
 1<sup>3</sup>/<sub>4</sub>"x4" x1<sup>3</sup>/<sub>16</sub>"



10x20x0,7 cm  
 4"x8" x<sup>9</sup>/<sub>32</sub>"



6,3x20x2 cm  
 2<sup>1</sup>/<sub>2</sub>"x8" x<sup>25</sup>/<sub>32</sub>"

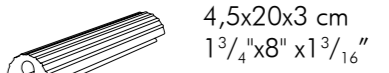

4,5x20x3 cm  
 1<sup>3</sup>/<sub>4</sub>"x8" x1<sup>3</sup>/<sub>16</sub>"

**BUMP**  
**BORDI VASCA**  
 POOLSIDES  
 BORDS DU BASSIN  
 SYSTEM BECKENRÄNDER

1. cod. BR 6,3x20x2 cm  
 cod. BR 2<sup>1</sup>/<sub>2</sub>"x8" x<sup>25</sup>/<sub>32</sub>"

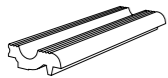

2. BP 10x20x0,7 cm  
 BP 4"x8" x<sup>9</sup>/<sub>32</sub>"

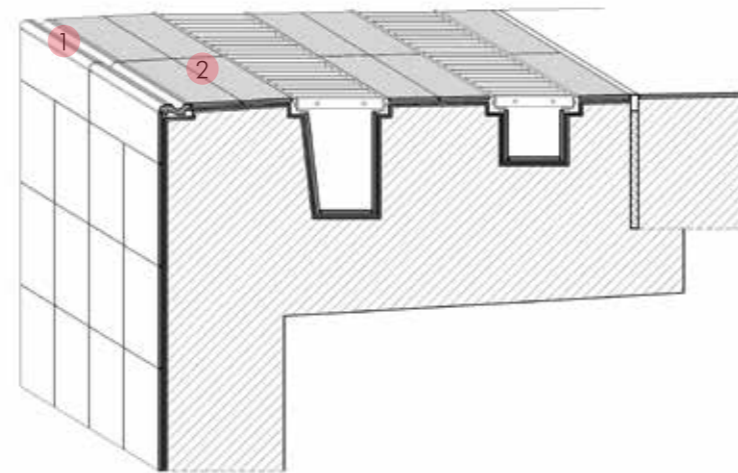
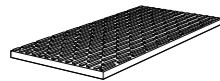

**Sistema Finlandese** Finnish  
 system  
 Système Finlandais  
 System Finland

1. cod. BC 10x20x0,7 cm  
 cod. BC 4"x8" x<sup>9</sup>/<sub>32</sub>"

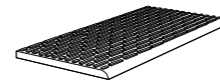

2. BP 10x20x0,7 cm  
 BP 4"x8" x<sup>9</sup>/<sub>32</sub>"

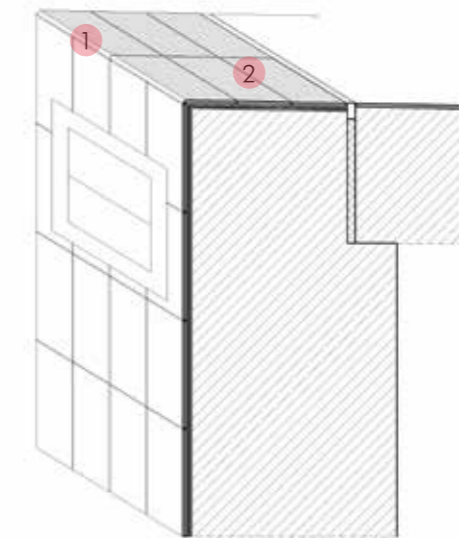
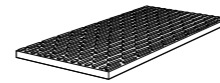

**Sistema Skimmer**  
 Skimmer system  
 Système Skimmer  
 Skimmer-System

**Sistema Zurigo**  
 Zurich system  
 Système Zurich  
 System mit Züricher Rinne

1. cod. FU 4,5x20x3 cm  
 cod. FU 1<sup>3</sup>/<sub>4</sub>"x8" x1<sup>3</sup>/<sub>16</sub>"

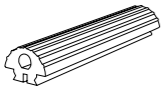

2. BP 10x20x0,7 cm  
 BP 4"x8" x<sup>9</sup>/<sub>32</sub>"

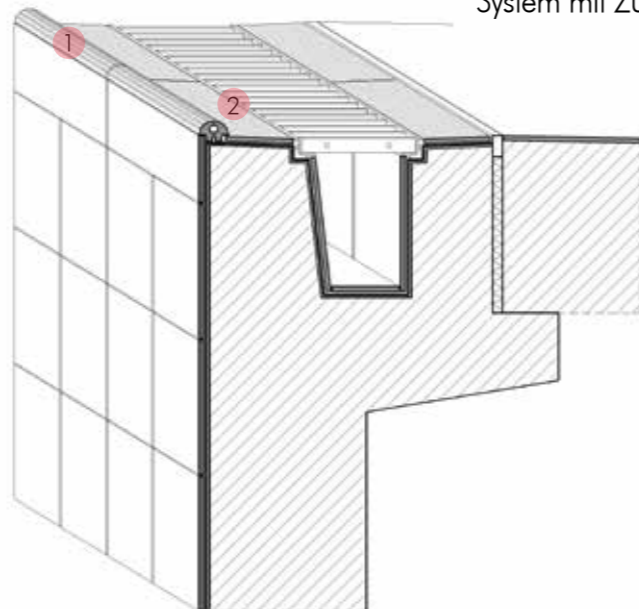
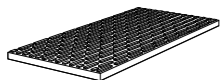

**BUMP**  
**BORDI VASCA**  
 POOLSIDES  
 BORDS DU BASSIN  
 SYSTEM BECKENRÄNDER

1. BP 10x20x0,7 cm  
 BP 4"x8" x<sup>9</sup>/<sub>32</sub>"

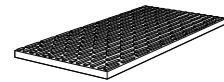

2. cod. N 2,5x20 cm  
 cod. N 1"x8"

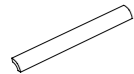

3. cod. M 2,5x20 cm  
 cod. M 1"x8"

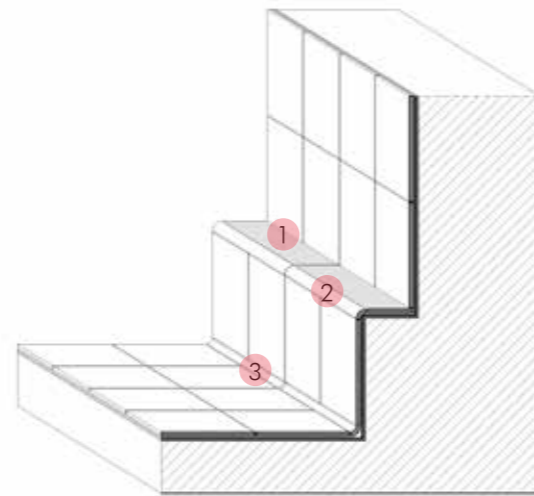
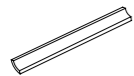

**Gradino di riposo**  
 Resting step  
 Marche de repos  
 Sitzstufen

1. BP 10x20x0,7 cm  
 BP 4"x8" x<sup>9</sup>/<sub>32</sub>"

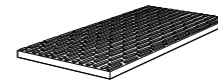

2. cod. N 2,5x20 cm  
 cod. N 1"x8"

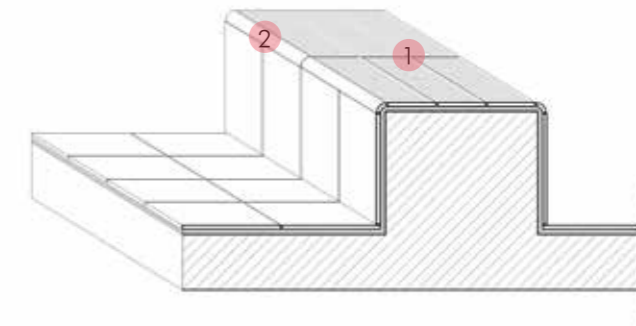
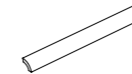

**Muretto**  
 Wall  
 Muret  
 Kleine Mauer

1. cod. BC 10x20x0,7 cm  
 cod. BC 4"x8" x<sup>9</sup>/<sub>32</sub>"

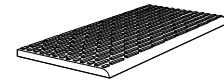

2. BP 10x20x0,7 cm  
 BP 4"x8" x<sup>9</sup>/<sub>32</sub>"

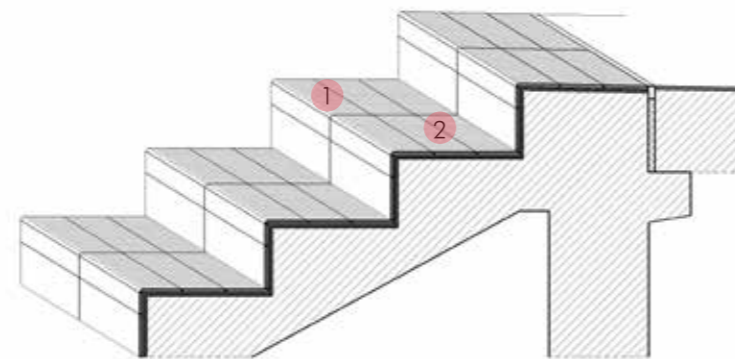
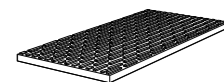

**Scala e gradini**  
 Ladder and steps  
 Escalier et marches  
 Treppe und Stufen



# SYSTEM

GIUNTO E COMPONENTITÀ DEI FORMATI/  
MODULARITY AND LAYING/  
JOINT ET MODULARITÉ DES FORMATS/  
FUGEN UND ZUSAMMENSTELLBARKEIT DER  
FORMATE

PEZZI SPECIALI/  
TRIMS/  
PIÈCES SPÉCIALES/  
TECHNISCHE FORMSTÜCKE

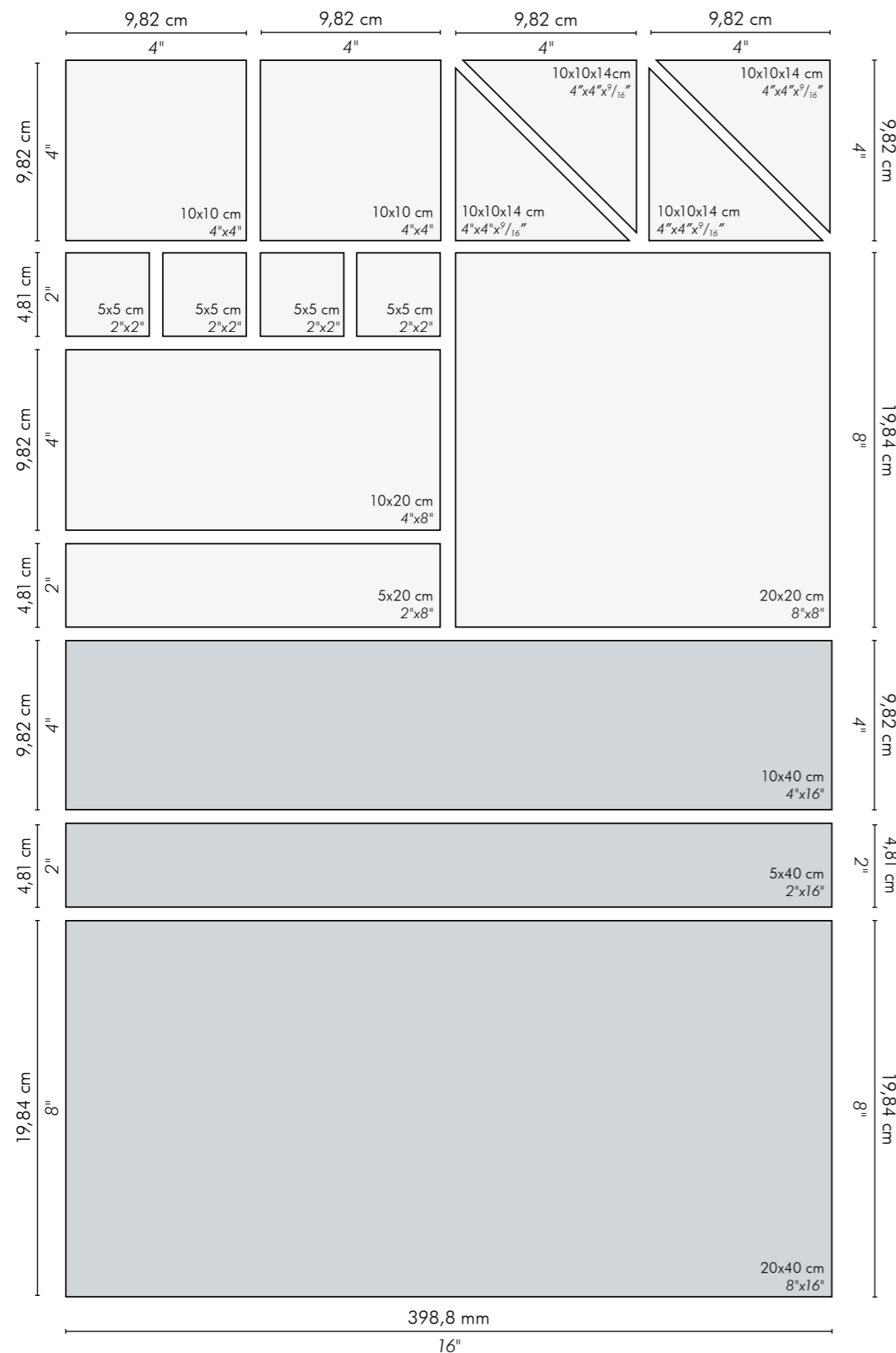

## Giunto e componibilità dei formati

Le piastrelle di tutte le collezioni Ceramica Vogue sono progettate per essere montate in combinazione tra loro: i calibri dei diversi formati sono quindi compatibili. La possibilità di combinare secondo molteplici modalità i colori, le finiture e i formati rappresenta per i progettisti una soluzione ottimale, capace di soddisfare ogni tipo di esigenza tecnica senza tuttavia sottovalutare le necessità dettate da un'attenta ricerca estetica e decorativa. Le misure riportate indicano la dimensione di fabbricazione media riferita al calibro centrale di produzione. Le tolleranze di dimensione all'interno dello stesso calibro sono stabilite dalla normativa UNI EN 14411 e si compensano normalmente fugando il materiale come da noi indicato. È possibile che siano forniti calibri inferiori o superiori a quello centrale: ne deriva che le dimensioni di fabbricazione media possono variare di conseguenza. A questo proposito, si consiglia di indicare in fase di ordinazione dei materiali i formati che si intendono utilizzare in composizione e che dovranno perciò avere calibri compatibili.

Per ottenere un corretto risultato di posa il materiale deve essere posato con un giunto non inferiore a 2 mm (UNI 11493:2013).

## Modularity and laying

The tiles in all of the Ceramica Vogue collections were designed to be laid in combination: the calibers of the different sizes are therefore compatible. The possibility to combine colours, finishes and sizes in a multitude of different ways is an excellent solution for designers, allowing them to satisfy all kinds of technical requirements without underestimating the demands for decoration and style. The measurements provided indicate the average production size referring to the central caliber. The size tolerances within the same caliber are laid down in the standard UNI EN 14411 and are usually compensated by laying the material as per our instructions. It is possible that lower or higher calibers than the central one are supplied: thus the average manufacturing sizes may vary. In this regard, it is recommended to indicate in the order the sizes you intend to use for the composition, in order to ensure that they are supplied with compatible calibers.

To obtain a correct laying result the material should be laid with joints of no less than 2 mm (UNI 11493:2013).

## Joint et modularité des formats

Les carreaux de toutes les collections Ceramica Vogue sont conçus pour être montés assemblés les uns avec les autres: les calibres des différents formats sont donc compatibles. La possibilité d'assembler les couleurs, les finitions et les formats suivant de multiples modalités représente pour les concepteurs une solution optimale, capable de satisfaire chaque type d'exigence technique sans toutefois sous-évaluer les nécessités dictées par une attentive recherche esthétique et décorative. Les mesures reportées indiquent la dimension de fabrication moyenne référée au calibre central de production. Les tolérances de dimension à l'intérieur du même calibre sont établies par la norme UNI EN 14411 et se compensent normalement en jointoyant le matériau comme nous l'avons indiqué. Il est possible que les calibres fournis soient inférieurs ou supérieurs au calibre central: il en résulte donc que, par conséquent, les dimensions de fabrication moyenne peuvent varier. A ce sujet, il est conseillé d'indiquer, au moment de la commande des matériaux, les formats que l'on souhaite utiliser en assemblage et qui devront, par conséquent, présenter des calibres compatibles.

Afin d'obtenir un résultat de pose correct, le matériau doit être posé avec un joint non inférieur à 2 mm (UNI 11493:2013).

## Fugen und Zusammenstellbarkeit der Formate

Die Fliesen aller Kollektionen von Ceramica Vogue wurden entwickelt, um miteinander kombiniert zu werden: Die Werkmaße der verschiedenen Formate sind daher miteinander kompatibel. Die Farben, Oberflächenausführungen und Formate können auf vielfältige Weise kombiniert werden, dies ist eine optimale Lösung für Designer, da alle technischen Anforderungen erfüllt, ohne ästhetische Gesichtspunkte und dekorative Wirkung außen vor zu lassen. Die angegebenen Maßzahlen beziehen sich auf die durchschnittlichen Herstellungsmaße in Bezug auf das zentrale Herstellungsmaß. Die Größentoleranzen innerhalb des gleichen Werkmaßes werden von der Norm UNI-EN 14411 festgelegt und werden in der Regel kompensiert, wenn die Ware mit den von uns angegebenen Fugenmaßen verlegt wird. Es können niedrigere oder höhere Werkmaße als das zentrale Werkmaß geliefert werden: Daher können die mittleren Herstellungsgrößen entsprechend variieren. Aus diesem Grund bitten wir Sie bei der Bestellung der Ware die Formate anzugeben, die miteinander kombiniert werden sollen und daher kompatible Werkmaße aufweisen müssen.

Für ein einwandfreies Ergebnis muss die Ware immer mit einer Fuge von mindestens 2 mm verlegt werden (UNI 11493:2013).

○ ≙ 0,85 cm (5x40 cm - 10x40 cm - 20x40 cm)  
 ≙ 2<sup>1</sup>/<sub>64</sub>" (2"x16" - 4"x16" - 8"x16")

○ ≙ 0,7 cm (5x5 cm - 10x10 cm - 10x10x14 cm - 10x20 cm - 20x20 cm)  
 ≙ 9<sup>1</sup>/<sub>32</sub>" (2"x2" - 4"x4" - 4"x4" 4<sup>33</sup>/<sub>64</sub>" - 4"x8" - 8"x8")

# PEZZI SPECIALI

TRIMS

PIÈCES SPÉCIALES

TECHNISCHE FORMSTÜCKE

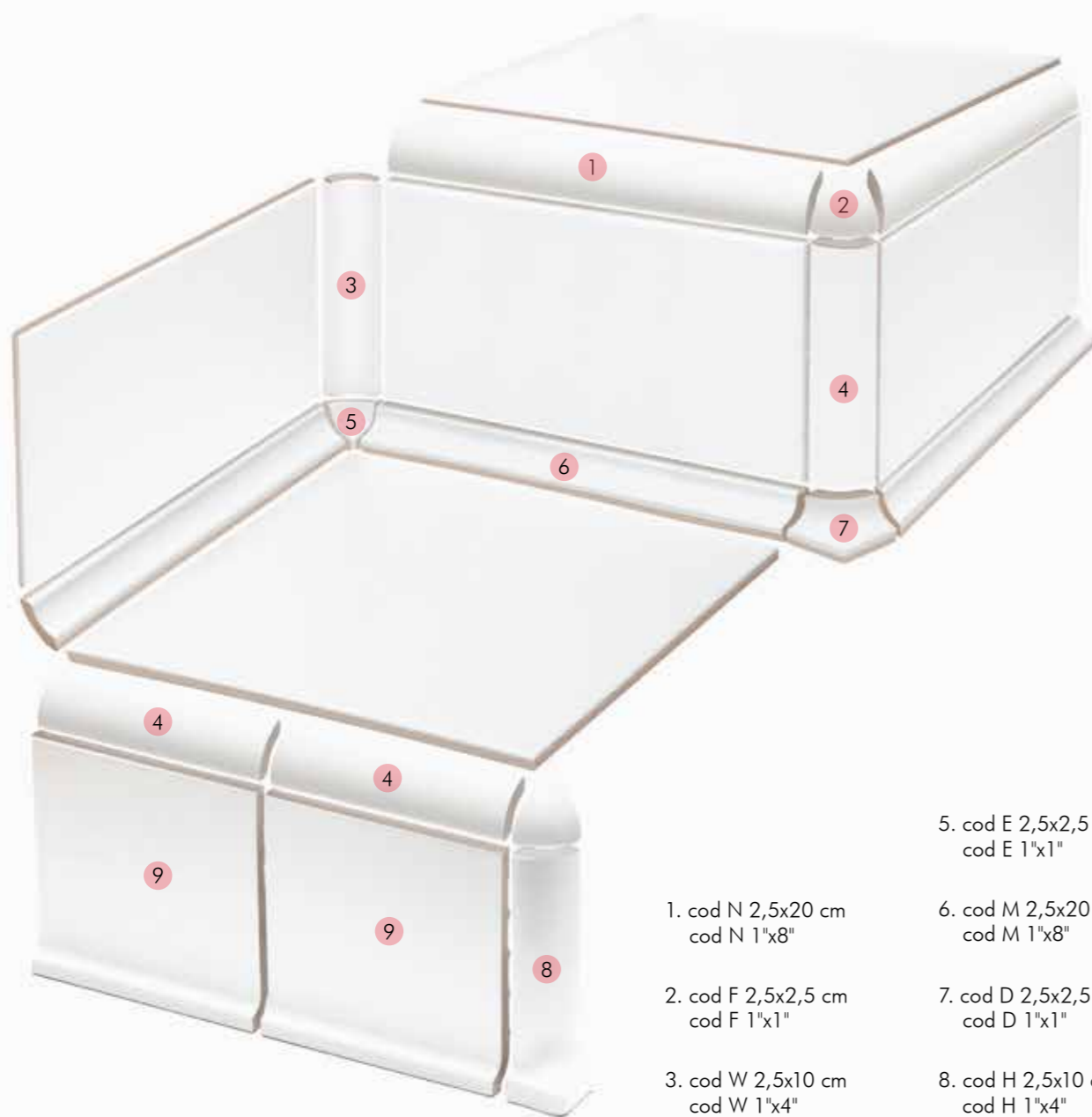

1. cod N 2,5x20 cm  
cod N 1"x8"

2. cod F 2,5x2,5 cm  
cod F 1"x1"

3. cod W 2,5x10 cm  
cod W 1"x4"

4. cod K 2,5x10 cm  
cod K 1"x4"

5. cod E 2,5x2,5 cm  
cod E 1"x1"

6. cod M 2,5x20 cm  
cod M 1"x8"

7. cod D 2,5x2,5 cm  
cod D 1"x1"

8. cod H 2,5x10 cm  
cod H 1"x4"

9. cod Z 10x10 cm  
cod Z 4"x4"



1. cod U 10x10x0,7 cm  
cod U 4"x4" x<sup>9</sup>/<sub>32</sub>"

2. cod X 10x20x0,7 cm  
cod X 4"x8" x<sup>9</sup>/<sub>32</sub>"

3. cod N 2,5x20 cm  
cod N 1"x8"

4. cod C 2,5x2,5 cm  
cod C 1"x1"

5. cod I 10x20x0,7 cm  
cod I 4"x8" x<sup>9</sup>/<sub>32</sub>"

6. cod G 2,5x10 cm  
cod G 1"x4"

Quadra 2,5x20

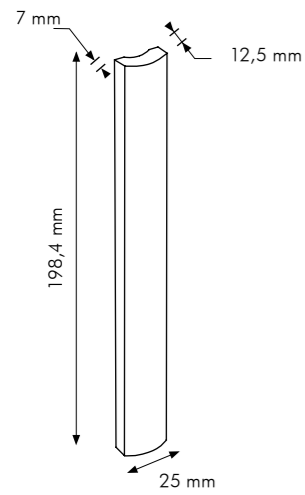

Stick 1,2x20

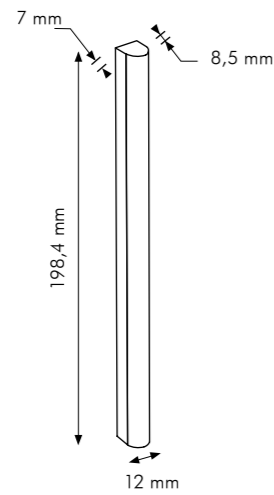

cod. M 2,5x20

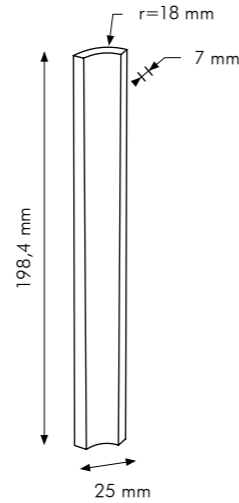

cod. N 2,5x20

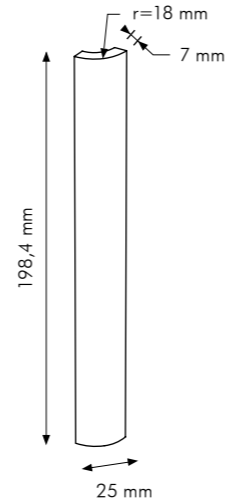

cod. I 10x20

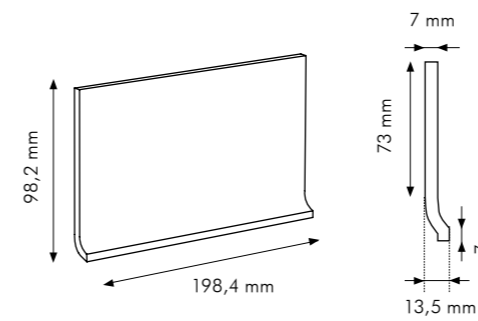

cod. Z 10x10

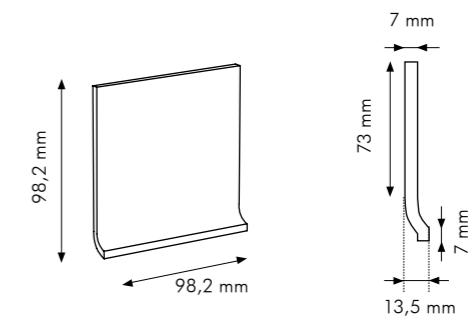

cod. W 2,5x10

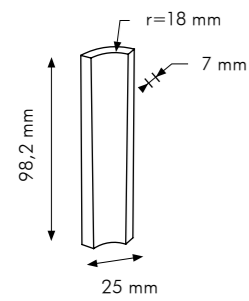

cod. K 2,5x10

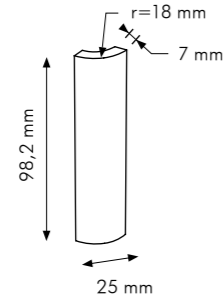

cod. G 2,5x10

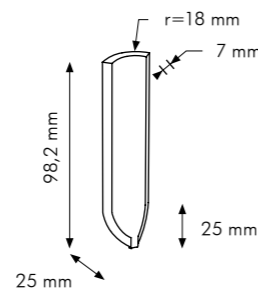

cod. H 2,5x10

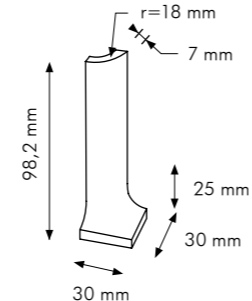

Bordo cod. B 10x10

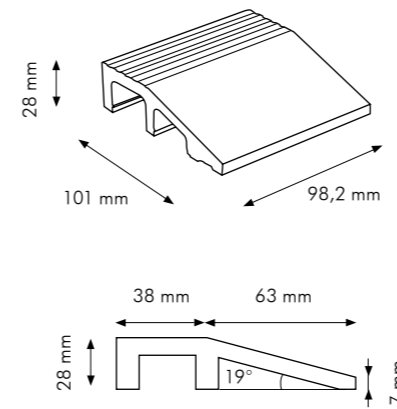

Spigolo cod. E 10x10

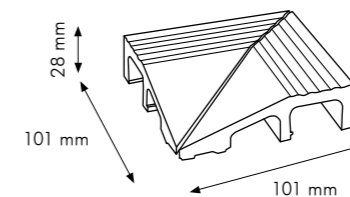

Angolo cod. I 10x10

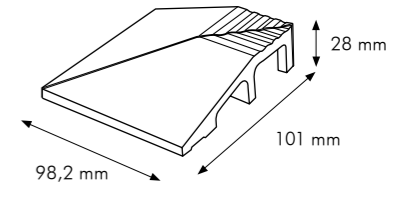

cod. C 2,5x2,5

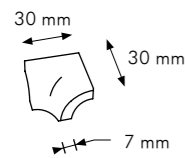

cod. D 2,5x2,5

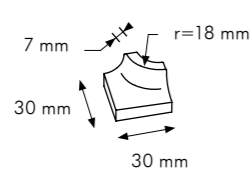

cod. F 2,5x2,5

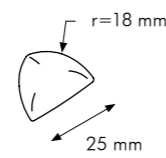

cod. E 2,5x2,5

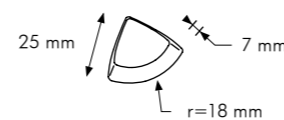

cod. BR 6,3x20

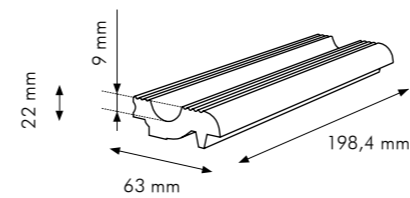

cod. FU 4,5x20

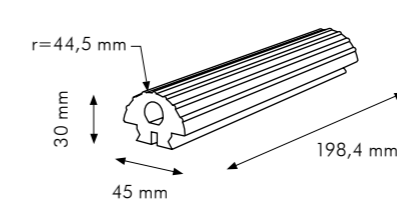

Special Pool Special Pool Special Pool Special Pool

cod. BC 10x20

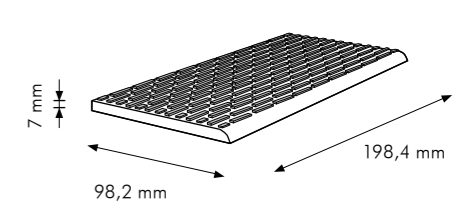

cod. X 10x20

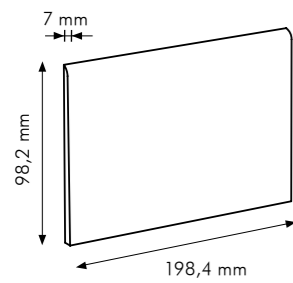

cod. U 10x10

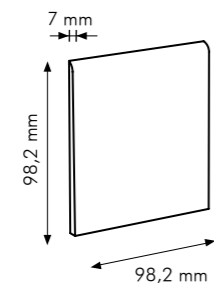

Battiscopa 9,5x40

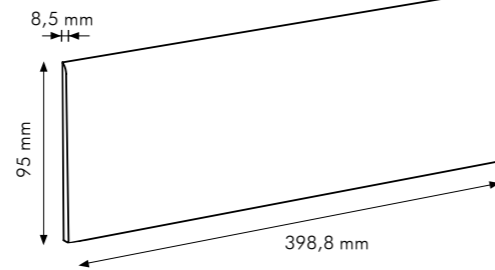

cod. BR1 6,3x10

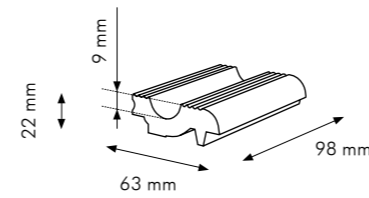

cod. FU1 4,5x10

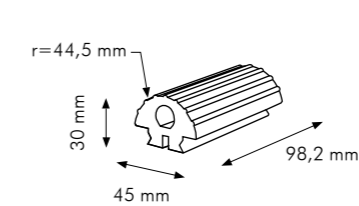

cod. BC1 10x10

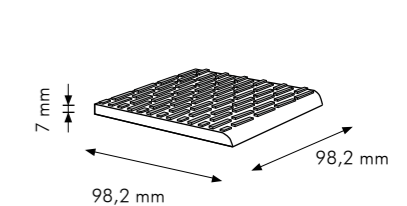

# SCHEDE TECNICHE

## TECHNICAL CHARTS

### FICHES TECHNIQUES

#### TECHNISCHE INFORMATIONEN

Voci di capitolato / Tender specifications / Détail des appels d'offre / Ausschreibungstext

Piastrelle di ceramica pressate a secco con basso assorbimento di acqua (0,5% < Eb ≤ 3%) Gruppo B1b - M - GL EN 14411:2016 appendice H.  
*Glazed ceramic tiles, dry pressed with low water absorption (0,5% < Eb ≤ 3%) Group B1b - M - GL EN 14411:2016 H appendix.*  
*Carreaux ceramiques émaillés, pressés à sec à faible absorption d'eau (0,5% < Eb ≤ 3%) Groupe B1b - M - GL EN 14411:2016 annexe H.*  
*Keramische glasierte Fliesen, trockengepresst, geringer Wasseraufnahme (0,5% < Eb ≤ 3%) Gruppe B1b - M - GL EN 14411:2016 H Anhang.*

#### Commenti:

La modularità e le caratteristiche dimensionali delle piastrelle Ceramica Vogue presentano valori decisamente migliorativi rispetto alle prescrizioni delle norme, che ottimizzano il risultato estetico riducendo al contempo i costi di posa. Vogue è un prodotto facile da posare. I test relativi alle proprietà chimiche confermano che i prodotti di Ceramica Vogue forniscono prestazioni elevate per quanto riguarda la facilità di manutenzione, resistenza alle macchie, igienicità. In caso di particolari esigenze relative alla resistenza chimica, sono disponibili, a richiesta, test specifici.

#### Remarks:

*Modularity and dimensional characteristics of the Ceramica Vogue ceramic tiles are definitely over the prescriptions of the norms, enhancing the aesthetical effect and reducing at the same time the laying costs. The Vogue product is easy to lay. The tests about chemical properties confirm high performances of the Ceramica Vogue products concerning an easy maintenance, resistance to stains, hygienic conditions. In case of particular requests concerning the chemical resistance, specific tests are available on demand.*

#### Commentaires:

*La modularité et les caractéristiques dimensionnelles des carreaux Ceramica Vogue présentent des valeurs nettement au-dessus des prescriptions des normes, afin d'optimiser le résultat esthétique en réduisant en même temps les coûts de pose. Vogue est donc un produit facile à poser. Les tests relatifs aux propriétés chimiques confirment que Ceramica Vogue donne des prestations élevées en ce qui concerne la facilité d'entretien, résistance aux taches, hygiène. Pour des nécessités spécifiques aux résistances chimiques, les tests spécifiques sont disponibles sur demande.*

#### Hinweise:

*Die Modularität sowie die charakteristischen Dimensionen der Ceramica Vogue fliesen sind hochwertig und übersteigen die erforderlichen Normwerte, optimieren das esthetische Verlegebild und sind nicht so verlegkostenintensiv. Voguefliesen sind einfach zu verlegen! Die Prüfungsergebnisse der Säureteste bestätigen daß die Ceramica Vogue eine hohe Resistenz gegen Flechenbildung aufweist und somit einfach in der Pflege, Reinigung und Hygiene ist. Sofern besondere Eigenschaften hinsichtlich divv. chemischen Reaktionen gefordert werden, liegen auf Abruf, spezielle Testergebnisse vor.*

Dimensioni e qualità della superficie / Dimensions and surface quality / Dimensions et qualité de la surface / Abmessungen und Qualität der Oberfläche

formato nominale nominal shape format nominal Nennmaße	dimensione di fabbricazione actual size format réel effektive Maße	metodo di prova test methods méthode d'essai Prüfverfahren	requisiti requirements exigences Anforderungen
5x5 cm	lati - sides côtés - Seiten: 48,1x48,1 mm spessore - thickness épaisseur - Stärke: 7 mm	EN ISO 10545-2	
5x20 cm	lati - sides côtés - Seiten: 48,1x198,4 mm spessore - thickness épaisseur - Stärke: 7 mm	EN ISO 10545-2	lati - sides côtés - Seiten: ± 0,6% spessore - thickness épaisseur - Stärke: ± 5%
5x40 cm	lati - sides côtés - Seiten: 48,1x398,8 mm spessore - thickness épaisseur - Stärke: 8,5 mm	EN ISO 10545-2	lati - sides côtés - Seiten: ± 0,6% spessore - thickness épaisseur - Stärke: ± 5%
10x10 cm	lati - sides côtés - Seiten: 98,2x98,2 mm spessore - thickness épaisseur - Stärke: 7 mm	EN ISO 10545-2	lati - sides Seiten côtés: ± 0,9 mm spessore - thickness épaisseur - Stärke: ± 0,5 mm
10x10x14 cm	lati - sides côtés - Seiten: 98,2x98,2x138,8 mm spessore - thickness épaisseur - Stärke: 7 mm	EN ISO 10545-2	lati - sides Seiten côtés: ± 0,9 mm spessore - thickness épaisseur - Stärke: ± 0,5 mm
10x20 cm	lati - sides côtés - Seiten: 98,2x198,4 mm spessore - thickness épaisseur - Stärke: 7 mm	EN ISO 10545-2	lati - sides côtés - Seiten: ± 0,6% spessore - thickness épaisseur - Stärke: ± 5%
20x20 cm	lati - sides côtés - Seiten: 198,4x198,4 mm spessore - thickness épaisseur - Stärke: 7 mm	EN ISO 10545-2	lati - sides côtés - Seiten: ± 0,6% spessore - thickness épaisseur - Stärke: ± 5%
10x40 cm	lati - sides côtés - Seiten: 98,2x398,8 mm spessore - thickness épaisseur - Stärke: 8,5 mm	EN ISO 10545-2	lati - sides côtés - Seiten: ± 0,6% spessore - thickness épaisseur - Stärke: ± 5%
20x40 cm	lati - sides côtés - Seiten: 198,4x398,8 mm spessore - thickness épaisseur - Stärke: 8,5 mm	EN ISO 10545-2	lati - sides côtés - Seiten: ± 0,6% spessore - thickness épaisseur - Stärke: ± 5%
Rettilinearità dei lati (superficie di esercizio) - Straightness of sides (working surface) - Côtés rectilignes (surface d'utilisation) - Geradheit der Seiten (Betriebsfläche)		EN ISO 10545-2	± 0,5%
Ortogonalità - Squareness - Orthogonalité - Rechtwinkligkeit		EN ISO 10545-2	± 0,5%
Planarità della superficie - Flatness - Planéité - Ebenflächigkeit		EN ISO 10545-2	± 0,5%
Qualità della superficie - Surface quality - Qualité de la surface - Oberflächenbeschaffenheit		EN ISO 10545-2	min. 95%











# SCHEDE TECNICHE

## TECHNICAL CHARTS





### FICHES TECHNIQUES

### TECHNISCHE INFORMATIONEN



#### Proprietà fisiche / Physical properties / Propriétés physiques / Physikalische Eigenschaften

prova test essai Prüfungen	metodo di prova test methods méthode d'essai Prüfverfahren	requisiti minimi minimum requirements exigences minimale Mindestanforderungen	risultati Vogue Vogue results résultats Vogue Vogue Ergebnisse
 Massa d'acqua assorbita (%) - Water absorption (%) - Masse d'eau absorbée (%) - Wasseraufnahme (%)	EN ISO 10545-3	0,5% < Eb ≤ 3,0 %	0,5% < Eb ≤ 3,0 %
 Resistenza di rottura Tensile strength Résistance aux ruptures Bruchfestigkeit	spessore - thickness - épaisseur - Stärke: ≥ 7,5 mm	EN ISO 10545-4	1.100 N min.
	spessore - thickness - épaisseur - Stärke: < 7,5 mm	EN ISO 10545-4	700 N min.
 Modulo di rottura - Modulus of rupture - Module de rupture - Biegefestigkeit	EN ISO 10545-4	30 N/mm2 min.	30 N/mm2 min.
 P.E.I. Resistenza all'abrasione (P.E.I.) - Abrasion resistance (P.E.I.) - Résistance à l'abrasion (P.E.I.) - Abriebbeständigkeit (P.E.I.)	EN ISO 10545-7	riportare la classe di abrasione - quote the abrasion class - donner la classe d'abrasion - geben Sie die Abnutzung Kategorie	vedi pagina prodotto - refer to product page - voir page produit - siehe Produktseite
 Coefficiente di dilatazione termica lineare Coefficient of linear thermal expansion - Coefficient de dilatation thermique linéaire - Lineare Wärmeausdehnungskoeffizient	EN ISO 10545-8	metodo di prova disponibile test method available méthode d'essai disponible Prüfverfahren vorhanden	< 6,9x10-6/°C
 Resistenza agli sbalzi termici - Thermal shock resistance - Résistance aux chocs thermiques - Temperaturwechselbeständigkeit	EN ISO 10545-9	metodo di prova disponibile test method available méthode d'essai disponible Prüfverfahren vorhanden	garantita - guaranteed - garantiert - garantie
 Resistenza al cavillo - Crazing resistance - Résistance au tressillage - Haarrissbeständigkeit	EN ISO 10545-11	richiesta - required demandé - gefordert	garantita - guaranteed - garantiert - garantie
 Resistenza al gelo - Frost resistance - Résistance au gel Frostbeständigkeit	EN ISO 10545-12	metodo di prova disponibile test method available méthode d'essai disponible Prüfverfahren vorhanden	garantita (escluso pezzi speciali - trims excepted - à l'exception des pièces spéciales - ausser Formstücke)
 Dilatazione dovuta all'umidità - Expansion to humidity - Dilatation à l'humidité - Ausdehnung bei Feuchtigkeit	EN ISO 10545-10	metodo di prova disponibile test method available méthode d'essai disponible Prüfverfahren vorhanden	< 0,04%
 Resistenza all'urto - Impact resistance - Résistance au choc - Impaktbeständigkeit	EN ISO 10545-5	metodo di prova disponibile test method available méthode d'essai disponible Prüfverfahren vorhanden	> 0,6 (vedi appendice P) - (see P appendix) - (voir l'annexe P) - (sehen Sie P Anhang)

#### Proprietà chimiche / Chemical properties / Propriétés chimiques / Chemische Eigenschaften

prova test essai Prüfungen	metodo di prova test methods méthode d'essai Prüfverfahren	requisiti requirements exigences Anforderungen	risultati Vogue Vogue results résultats Vogue Vogue Ergebnisse
 Resistenza alle macchie - Stain resistance - Résistance aux taches - Fleckenbeständigkeit	EN ISO 10545-14	classe 3 min.	3 min. (vedi appendice P) - (see P appendix) - (voir l'annexe P) - (sehen Sie P Anhang)
 Resistenza ai prodotti chimici d'uso domestico ed agli additivi per piscina - Resistance to chemical products for housekeeping and to the additives used in swimming- pools - Résistance aux produits de nettoyage pour la maison et aux additifs utilisés dans les piscines - Beständigkeit gegen Hausreinigungsmittel und gegen die in Schwimmbecken verwendeten chemischen Zusätze	EN ISO 10545-13	GB min.	GB min.
 Resistenza ad acidi e basi a bassa concentrazione Resistance to acids and bases at low concentrations - Résistance aux acides et basiques à faible concentration - Beständigkeit gegen Säuren und Basen niedriger Konzentration	EN ISO 10545-13	indicata dal produttore indicated by the producer indiquée par le producteur vom Hersteller angegeben	GLB min.
 Resistenza ad acidi e basi ad alta concentrazione Resistance to acids and bases at high concentrations Résistance aux acides et basiques à concentration élevée - Beständigkeit gegen Säuren und Basen hoher Konzentration	EN ISO 10545-13	metodo di prova disponibile test method available méthode d'essai disponible Prüfverfahren vorhanden	GHB min.
 Pb Cd Cessione di piombo e cadmio - Lead and cadmium losses - Perte de plomb et cadmium - Abgabe von Pb und Cd	EN ISO 10545-15	metodo di prova disponibile test method available méthode d'essai disponible Prüfverfahren vorhanden	disponibile a richiesta - available if required - disponible sur demande - vorhanden wenn erforderlich

#### Altre prove / Other tests / Autres essais / Weiteren Prüfungen

prova test essai Prüfungen	metodo di prova test methods méthode d'essai Prüfverfahren	requisiti requirements exigences Anforderungen	risultati Vogue Vogue results résultats Vogue Vogue Ergebnisse
 Resistenza dei colori alla luce - Colour resistance to light - Résistance des couleurs à la lumière - Lichtfestigkeit der Farben	DIN 51094	non previsto - not foreseen pas prévu - nicht vorgesehen	garantita - guaranteed - garantie - garantiert
 Reazione al fuoco - Reaction to the fire - Réaction au feu - Reaktion bei Feuer	senza prova without test sans essai ohne Prüfung	decisione 96/603/CE decision 96/603/CE - décision 96/603/CE - Entscheidung 96/603/CE	classe A1

# SCHEDE TECNICHE

## TECHNICAL CHARTS

### FICHES TECHNIQUES

#### TECHNISCHE INFORMATIONEN

#### Determinazione della pulibilità e analisi microbatterica

I materiali di Ceramica Vogue, previa accurata pulizia con prodotti specifici, non favoriscono il proliferare dei batteri (prova di laboratorio disponibile).

#### Determination of cleanability and microbacterial analysis

Ceramica Vogue materials, if properly cleaned with appropriate cleaning products, do not promote the proliferation of bacteria (laboratory tests available).

#### Détermination de la nettooyabilité et analyse microbactérienne

Les matériaux de Ceramica Vogue, grâce à un nettoyage soigné avec des produits adaptés, ne favorisent pas la prolifération des bactéries (test de laboratoire disponible).

#### Bestimmung der Reinigbarkeit und mikrobiologische Analyse

Die Materialien von Ceramica Vogue, wenn gründlich mit spezifischen Produkten gereinigt, begünstigen nicht die Bakterienverbreitung (Laborprobe verfügbar).

#### Conformità alla Normativa

Il materiale Ceramica Vogue (prima scelta) è conforme a quanto previsto dalla normativa UNI EN 14411-2012 - Appendice H. Il sistema di gestione applica quanto previsto dalle Norme della Serie ISO 9000, ISO 14000 e dal Regolamento CE761/2001 EMAS. L'intero ciclo produttivo è dotato di Autorizzazione Integrata Ambientale, ai sensi dell'art. 4 D.Lgs 372/99 (I.P.P.C)

#### Conformity to Standards

Ceramica Vogue material (best quality) complies with the provisions of standard UNI EN 14411-2012 - Appendix H. The management system applies the provisions of the Standards in the series ISO 9000, ISO 14000 and the CE761/2001 EMAS Regulation. The whole production cycle is covered by an Integrated Environmental Authorisation, pursuant to Art. 4 of Italian Legislative Decree (D.Lgs) 372/99 (I.P.P.C)

#### Conformité à la Norme

Le matériau Ceramica Vogue (premier choix) est conforme aux dispositions de la norme UNI EN 14411-2012 - Annexe H. Le système de gestion applique les dispositions de la norme de la série ISO 9000, ISO 14000 et du Règlement CE 761/2001 EMAS. L'ensemble du cycle de production fait l'objet d'une Autorisation Environnementale Intégrée en vertu de l'art. 4 du D.L. 372/99 (IPPC).

#### Konformität mit den Bestimmungen

Das Material von Ceramica Vogue (erste Wahl) entspricht den Vorgaben der Bestimmung UNI EN 14411-2012 - Anhang H. Das Managementsystem wendet die Vorgaben der Bestimmungen der Reihe ISO 9000, ISO 14000 und der Regelung CE 761/2001 EMAS an. Der gesamte Produktionszyklus ist mit integrierter Umweltgenehmigung gemäß Art. 4 der Gesetzesverordnung 372/99 ausgestattet (I.P.P.C)

#### FLOORING

prova test essai Prüfungen	metodo di prova test methods méthods d'essai Prüfverfahren	requisiti requirements exigences Anforderungen				risultati Vogue Vogue results résultats Vogue Vogue Ergebnisse	
	determinazione proprietà antiscivolo: Determination of the anti-slip characteristics: Détermination des propriétés antiglissance: Bestimmung der rutschhemmenden Eigenschaft:	DIN 51130 grado scivolosità non-skid characteristics coefficient de glissance Rutschfestigkeitswert	R9 aderenza normale normal adhesion adhérence normale normale Adhäsion 6° ≤ a tot ≤ 10°	R10 aderenza media medium adhesion adhérence moyenne mittlere Adhäsion 10° ≤ a tot ≤ 19°	R11 aderenza elevata high adhesion adhérence élevée hohe Adhäsion 19° ≤ a tot ≤ 27°	a = angolo di inclinazione inclination angle Neigungswinkel angle de inclination	R10
	determinazione proprietà antiscivolo di zone bagnate a piedi nudi: Determination of the anti-slip characteristics for barefoot wet areas: Détermination des propriétés antiglissance dans environs mouillés à pieds nus: Bestimmung der rutschhemmenden Eigenschaft für nassbelastete Barfußbereiche:	DIN 51097 angolo inclinazione (°) inclination angle (°) angle d'inclinaison (°) Neigungswinkel (°)	A aderenza media medium adhesion adhérence moyenne mittlere Adhäsion ≥ 12 < 18	B aderenza elevata high adhesion adhérence élevée hohe Adhäsion ≥ 18 < 24	C aderenza forte strong adhesion adhérence forte starke Adhäsion ≥ 24		B (A+B)
	coefficiente di attrito: (1) asciutto (cuoio)   (2) bagnato (gomma) Coefficient of friction: (1) dry (leather)   (2) wet (Rubber) Coefficient de frottement: (1) sec (cuir)   (2) mouillé (caoutchouc) Reibungsbeiwert: (1) trocken (Haut)   (2) nass (Gummi)	B.C.R.A.	μ ≤ 0,19 scivolosità pericolosa dangerous slipperiness glissance dangereuse sehr hohe Rutschgefahr	0,20 ≤ μ ≤ 0,39 scivolosità eccessiva extreme slipperiness glissance excessive hohe Rutschgefahr	0,40 ≤ μ ≤ 0,74 attrito soddisfacente satisfactory friction frottement satisfaisant betreidende Reibung	μ ≥ 0,75 attrito eccellente excellent friction frottement excellent hervorragende Reibung	(1) μ > 0,40 (2) μ > 0,40
	Pendulum test UK	BS 7976-2:2002	metodo di prova disponibile - test method available - méthode d'essai disponible - Prüfverfahren vorhanden				dry >36 wet -
<b>GRIP</b>							
	determinazione proprietà antiscivolo: Determination of the anti-slip characteristics: Détermination des propriétés antiglissance: Bestimmung der rutschhemmenden Eigenschaft:	DIN 51130 grado scivolosità non-skid characteristics coefficient de glissance Rutschfestigkeitswert	R9 aderenza normale normal adhesion adhérence normale normale Adhäsion 6° ≤ a tot ≤ 10°	R10 aderenza media medium adhesion adhérence moyenne mittlere Adhäsion 10° ≤ a tot ≤ 19°	R11 aderenza elevata high adhesion adhérence élevée hohe Adhäsion 19° ≤ a tot ≤ 27°	a = angolo di inclinazione inclination angle Neigungswinkel angle de inclination	R11
	determinazione proprietà antiscivolo di zone bagnate a piedi nudi: Determination of the anti-slip characteristics for barefoot wet areas: Détermination des propriétés antiglissance dans environs mouillés à pieds nus: Bestimmung der rutschhemmenden Eigenschaft für nassbelastete Barfußbereiche:	DIN 51097 angolo inclinazione (°) inclination angle (°) angle d'inclinaison (°) Neigungswinkel (°)	A aderenza media medium adhesion adhérence moyenne mittlere Adhäsion ≥ 12 < 18	B aderenza elevata high adhesion adhérence élevée hohe Adhäsion ≥ 18 < 24	C aderenza forte strong adhesion adhérence forte starke Adhäsion ≥ 24		C (A+B+C)
	coefficiente di attrito: (1) asciutto (cuoio)   (2) bagnato (gomma) Coefficient of friction: (1) dry (leather)   (2) wet (Rubber) Coefficient de frottement: (1) sec (cuir)   (2) mouillé (caoutchouc) Reibungsbeiwert: (1) trocken (Haut)   (2) nass (Gummi)	B.C.R.A.	μ ≤ 0,19 scivolosità pericolosa dangerous slipperiness glissance dangereuse sehr hohe Rutschgefahr	0,20 ≤ μ ≤ 0,39 scivolosità eccessiva extreme slipperiness glissance excessive hohe Rutschgefahr	0,40 ≤ μ ≤ 0,74 attrito soddisfacente satisfactory friction frottement satisfaisant betreidende Reibung	μ ≥ 0,75 attrito eccellente excellent friction frottement excellent hervorragende Reibung	(1) μ > 0,40 (2) μ > 0,40
	Pendulum test UK	BS 7976-2:2002	metodo di prova disponibile - test method available - méthode d'essai disponible - Prüfverfahren vorhanden				dry >36 wet -

# SCHEDE TECNICHE

## TECHNICAL CHARTS









### FICHES TECHNIQUES

#### TECHNISCHE INFORMATIONEN

#### BUMP

prova test essai Prüfungen	metodo di prova test methods méthode d'essai Prüfverfahren	requisiti requirements exigences Anforderungen	risultati Vogue Vogue results résultats Vogue Vogue Ergebnisse			
determinazione proprietà antiscivolo di zone bagnate a piedi nudi: Determination of the anti-slip characteristics for barefoot wet areas: Détermination des propriétés antiglissance dans environnements mouillés à pieds nus: Bestimmung der rutschemmenden Eigenschaft für nassbelastete Barfußbereiche:	DIN 51097 angolo inclinazione (°) inclination angle (°) angle d'inclinaison (°) Neigungswinkel (°)	A aderenza media medium adhesion mittlere Adhäsion adhérence moyenne ≥ 12 < 18	B aderenza elevata high adhesion hohe Adhäsion adhérence élevée ≥ 18 < 24	C aderenza forte strong adhesion starke Adhäsion adhérence forte ≥ 24	C (A+B+C)	
valutazione dello spazio di dislocazione assessment of displacement space estimation de l'espace de positionnement Beurteilung des Verlegungsraums	DIN 51130 volume cavità deflusso (cm <sup>3</sup> /dm <sup>2</sup> ) Volume of outflow cavity volume cavité d'écoulement Abflusskavitätsvolumen	V4 4 cm <sup>3</sup> /dm <sup>2</sup>	V6 6 cm <sup>3</sup> /dm <sup>2</sup>	V8 8 cm <sup>3</sup> /dm <sup>2</sup>	V10 10 cm <sup>3</sup> /dm <sup>2</sup>	V6

#### ASTM TEST RESULTS

Test	Test methods	Requirements	Vogue results
 Water absorption (%)	C 373	0,5% to 3%	0,5% to 3%
 Breaking strenght in N	C 648	≥ 250 lbf	≥ 250 lbf
 Chemical resistance	C 650	No requirement	Pass
 Stain resistance	C 1378	Pass	Pass
 Crazing resistance	C 424	Pass	Pass
 Frost resistance	C 1026:2013	As reported	Pass
 Bond strength of ceramic tile to portland cement	C 482 - 02 (2009)	> 0,34 MPa	1,41 MPa fibre glass mesh mounted 1,32 MPa fibre glass not mesh mounted
 Thermal shock	C484	No sample must show visible effects	Pass

#### FLOORING

Test	Test methods	Requirements	Vogue results
Dry Coefficient of friction	C 1028	anti slip > 0,60	> 0,60
Wet Coefficient of friction	C 1028	anti slip > 0,60	> 0,60

#### GRIP

Test	Test methods	Requirements	Vogue results
Dry Coefficient of friction	C 1028	anti slip > 0,60	> 0,60
Wet Coefficient of friction	C 1028	anti slip > 0,60	> 0,60

#### Marchatura CE

Il Regolamento Europeo 305/2011 (CPR) abroga la Direttiva 89/106/CEE sui prodotti da costruzione (CPD) introducendo dal 01/07/2013 alcune importanti novità nell'ambito della Marchatura CE dei prodotti da costruzione.

La Dichiarazione di Conformità dei prodotti da costruzione viene sostituita dalla Dichiarazione di Prestazione (DoP) con diverso significato e contenuto.

In assenza di questa dichiarazione i prodotti non possono circolare all'interno dei confini dell'Unione Europea.

La presenza del marchio CE su tutti gli imballi di Ceramica Vogue attesta che, il prodotto in essi contenuto è conforme a quanto dichiarato nelle schede tecniche, e la costanza delle prestazioni del prodotto è stata verificata ed attestata a garanzia dell'utilizzatore.

#### CE mark

European Regulation 305/2011 (CPR) abrogates Directive 89/106/EEC concerning construction products, introducing a number of important changes concerning the CE mark on construction products effective 01/07/2013.

The Declaration of Conformity for construction products is replaced by the Declaration of Performance (DoP), with a different meaning and different content.

Products cannot circulate within the European Union without this declaration.

The presence of the CE mark on all Ceramica Vogue packages demonstrates that the product contained in them conforms to the declarations of the technical information sheets and that the constancy of the product's performance has been tested as a guarantee for the user.

#### Symbole CE

Le règlement européen 305/2011 (CPR) abroge la directive 89/106/CEE sur les produits de construction (CPD) en introduisant depuis le 01/07/2013 certaines nouveautés importantes dans le cadre du symbole CE des produits de construction.

La déclaration de conformité des produits de construction est remplacée par la déclaration de prestation (DoP) avec un sens et un contenu différents.

En l'absence de cette déclaration, les produits ne peuvent pas circuler dans le territoire de l'Union Européenne.

La présence du symbole CE sur tous les emballages de Ceramica Vogue atteste que le produit qu'ils contiennent est conforme à ce qui est déclaré sur les fiches techniques, et que la constance des prestations du produit a été vérifiée et attestée comme garantie pour l'utilisateur.

#### CE -Kennzeichnung

Die europäische Regelung 305/2011 (BPR) ersetzt die Richtlinie 89/106/EWG hinsichtlich Bauprodukten, indem ab dem 01.07.2013 einige wichtige Neuheiten im Rahmen der CE -Kennzeichnung der Bauprodukte eingeführt werden.

Die Konformitätserklärung der Bauprodukte wird von der Leistungserklärung (LE) mit anderer Bedeutung und anderem Inhalt abgelöst.

In Ermangelung dieser Erklärung dürfen die Produkte innerhalb der Grenzen der EU nicht mehr in Umlauf gebracht werden.

Das Vorliegen des CE -Zeichens auf allen Verpackungen von Ceramica Vogue bescheinigt, dass das darin enthaltene Produkt den Erklärungen in den technischen Datenblättern entspricht und dass die Konstanz der Leistungen des Produkts als Garantie des Benutzers überprüft und bescheinigt wurde.



# SCHEDE TECNICHE

## TECHNICAL CHARTS

## FICHES TECHNIQUES

## TECHNISCHE INFORMATIONEN

### Manutenzione e pulizia

La qualità di un rivestimento in piastrelle ceramiche dipende, oltre che da una buona progettazione e da una corretta posa, anche dalla cura che verrà rivolta alle superfici.

Le piastrelle Ceramica Vogue in grès smaltato in pasta bianca ingelivo sono resistenti, igieniche e facili da pulire, non richiedono particolari cure ma solo l'applicazione di alcune elementari norme di pulizia. È importante distinguere tra pulizia di fine cantiere e pulizia ordinaria.

#### Pulizia di fine cantiere

Oltre a mantenere sempre protette le superfici durante la fasi di cantiere, è di fondamentale importanza curare la prima pulizia.

Questa operazione ha lo scopo di eliminare ogni traccia e residuo di posa dalla superficie delle piastrelle. Prima del lavaggio è importante rimuovere con un aspiratore lo sporco grossolano evitando di rigare la superficie delle piastrelle. La pulizia deve essere fatta con prodotti in commercio tipo Deterdek ([www.filachim.com](http://www.filachim.com)), Keranet ([www.mapei.com](http://www.mapei.com)) o prodotti similari. Si raccomanda di seguire rigorosamente le indicazioni riportate sulle schede tecniche dei prodotti utilizzati e comunque di fare delle prove dei prodotti di pulizia su una piccola porzione di una piastrella prima di eseguire la pulizia totale della superficie.

#### Pulizia ordinaria

Per la pulizia ordinaria è bene usare prodotti in grado di eliminare eventuali macchie di sporco senza però intaccare la smaltatura superficiale, evitare quindi sostanze molto aggressive quali prodotti a base acida.

Usare semplici prodotti adatti alla pulizia della ceramica. Per migliorare l'efficacia dei detergenti diluirli con acqua calda.

#### Norme generali

Sostanze abrasive o strumenti per la pulizia quali spugne abrasive o spazzole eccessivamente dure sono sconsigliati in quanto potrebbero provocare sulla superficie delle piastrelle graffi o segni impossibili poi da eliminare.

Sui prodotti con caratteristiche antiscivolo evitare assolutamente l'utilizzo di prodotti lavaincera o cere.

Nel caso di locali comunicanti con l'esterno è indispensabile utilizzare zerbini per ridurre l'apporto di agenti abrasivi.

### Maintenance

*The quality of a ceramic wall tile depends not only on proper design and laying, but also the care taken of the surface thereafter. Ceramica Vogue frost resistant white body glazed stoneware tiles are hard-wearing, hygienic and easy to clean. They require no particular maintenance other than the application of a number of simple cleaning rules.*

*It is important to distinguish between the cleaning to be carried out when the building work is complete and ordinary cleaning.*

#### *Cleaning after building work is completed*

*In addition to keeping surfaces protected during the various phases of the building work, it is of fundamental importance to ensure the tiles are cleaned properly for the first time once the building work is complete.*

*The purpose of this operation is to remove all traces and residue from the laying process from the surface of the tiles. Before washing the tiles, it is important to vacuum off the worst of the dirt, without scratching the surface of the tiles. Cleaning must be done using products such as Deterdek ([www.filachim.com](http://www.filachim.com)), Keranet ([www.mapei.com](http://www.mapei.com)) or similar.*

*The indications on the technical specifications of the products used must be followed very carefully, and all cleaning products should be tested on a small portion of a tile before proceeding to clean the whole surface.*

#### *Ordinary cleaning*

*For ordinary cleaning, it is best to use products able to remove any dirty marks without damaging the surface glaze, avoiding particularly aggressive (e.g. acid-based) products.*

*Use simple products suitable for cleaning ceramics. To improve the efficacy of the cleaning agents, dilute them in hot water.*

#### *General rules*

*Abrasive substances or cleaning instruments such as abrasive sponges or excessively hard brushes should be avoided, because they could scratch the surface or leave marks that will be impossible to remove.*

*On products with anti-slip characteristics, wash and wax or wax products must not be used.*

*For areas that lead directly outdoors, mats must be used in order to limit the abrasive agents brought in.*

### Entretien et nettoyage

*Au-delà d'une conception intelligente et d'une pose dans les règles de l'art, la qualité d'un revêtement céramique dépend aussi du soin qui sera apporté aux surfaces. Les carrelages Ceramica Vogue en grès émaillé à pâte blanche ingélif sont résistants, hygiéniques et faciles à nettoyer. Ils n'exigent aucun soin particulier, seulement quelques règles élémentaires de propreté. Il est important de faire la différence entre le nettoyage de fin de chantier et le nettoyage ordinaire.*

#### *Nettoyage de fin de chantier*

*En plus de protéger les surfaces pendant toute la durée du chantier, il est fondamental de soigner le premier nettoyage.*

*Cette opération a pour but d'éliminer toute trace et résidu de pose présent à la surface du carrelage. Avant de procéder au lavage, il est important de passer l'aspirateur afin d'éliminer la saleté pour éviter de rayer les carreaux. Effectuer ensuite le nettoyage à l'aide de produits disponibles dans le commerce tels que Deterdek ([www.filachim.com](http://www.filachim.com)), Keranet ([www.mapei.com](http://www.mapei.com)) ou tout autre produit similaire.*

*Il est recommandé de suivre rigoureusement les indications figurant sur les fiches techniques des produits utilisés et, quoi qu'il en soit, de procéder à un essai sur une petite surface avant de passer au nettoyage du carrelage dans sa totalité.*

#### *Nettoyage ordinaire*

*Pour le nettoyage ordinaire, il est préférable d'utiliser des produits en mesure d'éliminer toute trace éventuelle de saleté sans abîmer l'émail des carreaux. Les substances très agressives, à base acide notamment, sont donc à éviter.*

*Utiliser les produits habituellement conseillés pour nettoyer le carrelage. Pour améliorer l'efficacité des détergents, vous pouvez les diluer dans de l'eau chaude.*

#### *Normes générales*

*Les substances abrasives, les éponges abrasives ou encore les brosses excessivement dures sont déconseillées car elles risquent de rayer la surface des carreaux ou de laisser des traces qui pourraient s'avérer impossible à éliminer.*

*Sur les produits antidérapants, éviter absolument d'utiliser des produits lavants-cirants ou des cires.*

*Si le carrelage est posé sur des pièces qui communiquent avec l'extérieur, il est indispensable d'utiliser des tapis-brosses afin de limiter l'apport d'agents abrasifs.*

### Pflege und Reinigung

*Die Qualität einer Verkleidung aus Keramikfliesen ist neben einer guten Planung und korrekten Verlegung auch von der Pflege abhängig, die den Oberflächen gewidmet wird.*

*Die Fliesen Ceramica Vogue aus frostbeständiges weißschieberiges glasiertes Gres-Steinzeug lackiertem Steingut sind resistent, hygienisch und leicht zu reinigen. Sie erfordern keine besondere Pflege sondern nur die Berücksichtigung einiger grundsätzlichen Reinigungsregeln. Es ist wichtig, zwischen der Baustellenendreinigung und einer normalen Reinigung zu unterscheiden.*

#### *Baustellenendreinigung*

*Die Oberflächen müssen während der Bauphase immer geschützt bleiben und außerdem ist es von absoluter Wichtigkeit, dass die erste Reinigung sorgfältig durchgeführt wird.*

*Hierzu müssen alle Spuren und Reste der Verlegung von den Fliesenoberflächen entfernt werden. Vor der Reinigung mit einem Staubsauger den groben Schmutz entfernen, dabei darauf achten, dass die Fliesenoberflächen nicht zerkratzt werden. Die Reinigung mit handelsüblichen Produkten, wie Deterdek ([www.filachim.com](http://www.filachim.com)), Keranet ([www.mapei.com](http://www.mapei.com)) oder ähnlich durchführen.*

*Es wird empfohlen, die Angaben auf den Datenblättern der verwendeten Produkte genau zu befolgen und in jedem Fall das Produkt auf einem kleinen Fliesenbereich zu testen, bevor die gesamte Fläche gereinigt wird.*

#### *Normale Reinigung*

*Für die normale Reinigung sollten Produkte verwendet werden, die eventuelle Flecken entfernen ohne die Glasur der Oberfläche anzugreifen - keine aggressiven oder säurehaltigen Mittel verwenden.*

*Einfache Produkte zur Fliesenreinigung verwenden. Für eine bessere Wirkung die Reinigungsmittel in heißem Wasser verdünnen.*

#### *Allgemeine Hinweise*

*Von Scheuermitteln oder Reinigungsgeräten, wie Scheuerschwämme oder harten Bürsten wird abgeraten, da sie die Oberfläche der Fliesen zerkratzen oder andere nicht entfernbare Spuren hinterlassen können.*

*Auf Produkten mit rutschhemmenden Eigenschaften dürfen auf keinen Fall wachshaltige Reinigungsmittel oder Bohnerwachs verwendet werden. In Bereichen mit externem Zugang muss eine Matte verwendet werden, um die Verunreinigung mit scheuernden Komponenten zu verringern.*



[www.ceramicavogue.it](http://www.ceramicavogue.it)

made in italy

Progetto architettonico e styling: Marcante - Testa  
Produzione immagini: Terzo Piano  
Fotolito e stampa: Ingraph  
Ufficio stampa: [info@sabrinagiacchetti.it](mailto:info@sabrinagiacchetti.it)  
Stampato in Italia Marzo 2021

Ceramica VOGUE  
è un marchio di



Socio Ordinario  
del GBC Italia



Ceramics of Italy



Ceramica VOGUE  
Via Papa Giovanni XIII, 100 - Loc. Vergnasco  
13882 Cerrione (BI) ITALIA  
T. +39.015.672.1  
Fax +39.015.671.626 (Italia)  
Fax +39.015.671.352 (Export)  
[info@cervogue.com](mailto:info@cervogue.com)

Ceramica  
VOGUE

TILES FOR ARCHITECTURE

[www.ceramicavogue.it](http://www.ceramicavogue.it)

made in italy