

FRONT FENDER FLARES

————— User Manual —————

2019-2022 Wrangler JT



| | |
|---------------------|-------------------------|
| Model: | NJK01H105-F |
| Material: | Q235A |
| Product Dimensions: | 44 x 7.7 x 21.3 inch |
| Package Dimensions: | 47.6 x 23.6 x 8.26 inch |
| Product Weight: | 27.5 lbs |

※ Thank you for purchasing the FENDERS FLARES. Please read this manual carefully and keep it properly if you need to refer to it afterward. If you need any support or assistance, please contact us with your product model number and order number, and our support team will help you solve problems.





⚠ WARNING

※ This product is designed primarily to enhance the appearance of the vehicle. Do not rely in any way on the components of this product to protect against injury or death in the event of an accident. To reduce the risk of serious injury or property damage, please read all safety messages and understand all instructions and procedure notices before attempting to install or use this product.







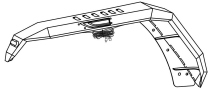

⚠ CAUTION

※ Properly torque and recheck fasteners and security of step tread after 250 miles and inspect frequently. Do not use if damaged.

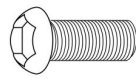
REQUIRED TOOLS

| | | | | |
|---|--|---|--|---|
| Socket  | Ratchet  | Allen Wrench  | Safety Glasses  | Masking tape  |
|---|--|---|--|---|

Parts Information

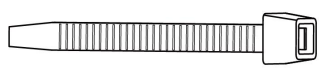
| Parts NO. | Parts Name | Size | Line Graph | Qty | Color |
|-----------|-----------------------|-----------|--|-----|-------------|
| / | Front Fender Flares | / |  | 2 | Black |
| / | Wire sets | / |  | 1 | Black |
| B15 | Half Head Allen Bolts | M8x20 |  | 18 | Dacro Black |
| W16 | Spring Washer | Φ8 |  | 18 | Dacro Black |
| N14 | Hex Flange Nuts | M8 |  | 18 | Dacro Black |
| W19 | Flat Washer | Φ8x24x2mm |  | 18 | Dacro Black |
| W17 | Nylon Washer | Φ8x16x0.5 |  | 18 | Black |
| / | H-Rubber Strip | / |  | / | Black |
| / | Ribbon | 5x250 |  | 10 | Black |

***Note: spare parts such as B15、W16、N14、W19、W17 are provided with 2PCS each (included in the number of parts details).**

Installation Instructions

Step 1: Open the carton and take out the parts. Check whether the number of components is complete.

Step 2: Remove the original front fender flares and original front inner fender flares and prepare the parts needed to install the Front Inner Fender Flares.

Step 3: Install the H-Rubber Strip.

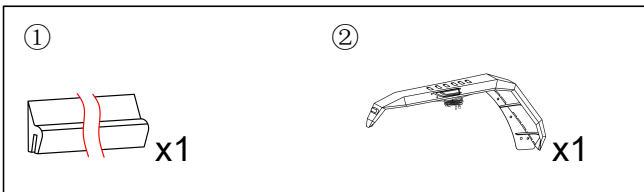



Step 4: Install the front fender flares and tighten the bolts.

| | | |
|----------------------------|----------------------------|---|
| <p>①</p> <p>x1</p> | <p>② B15: M8</p> <p>x8</p> | <p>③ W19: $\Phi 8$</p> <p>x8</p> |
| <p>④ N14: M8</p> <p>x8</p> | <p>⑤ N08: M6</p> <p>x8</p> | <p>⑥ W16</p> <p>x8</p> |

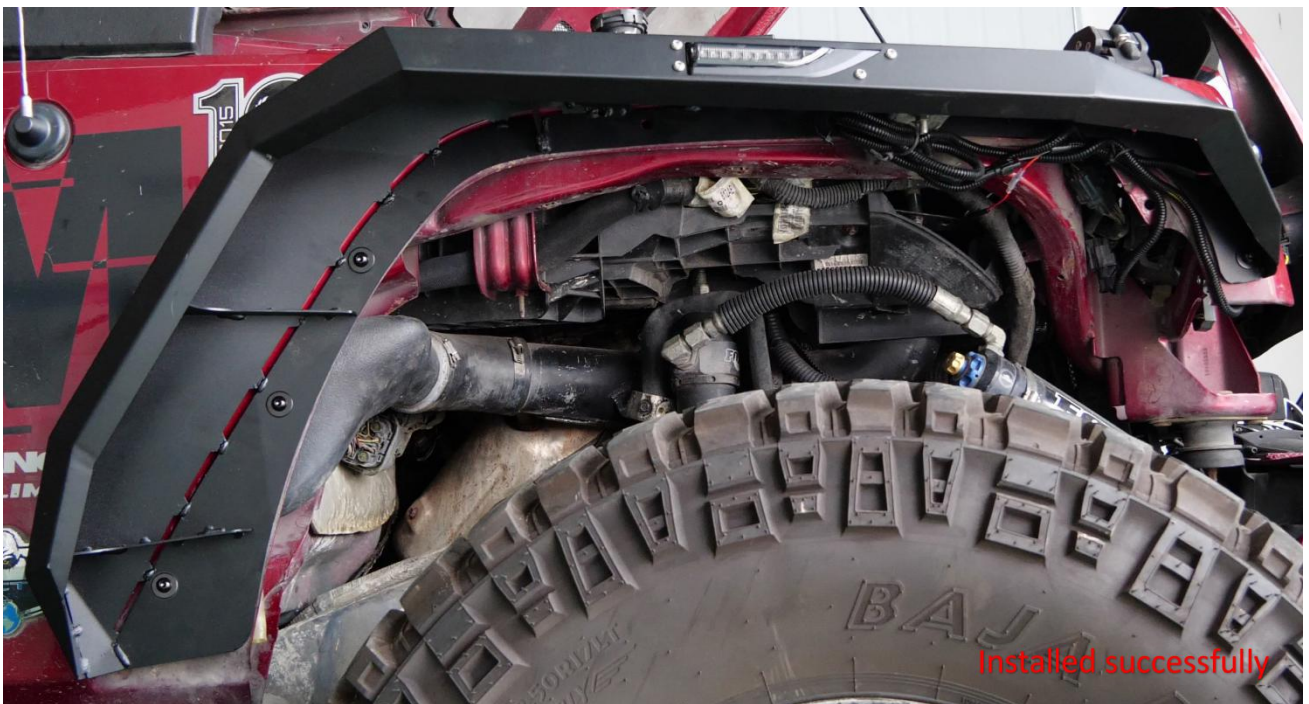
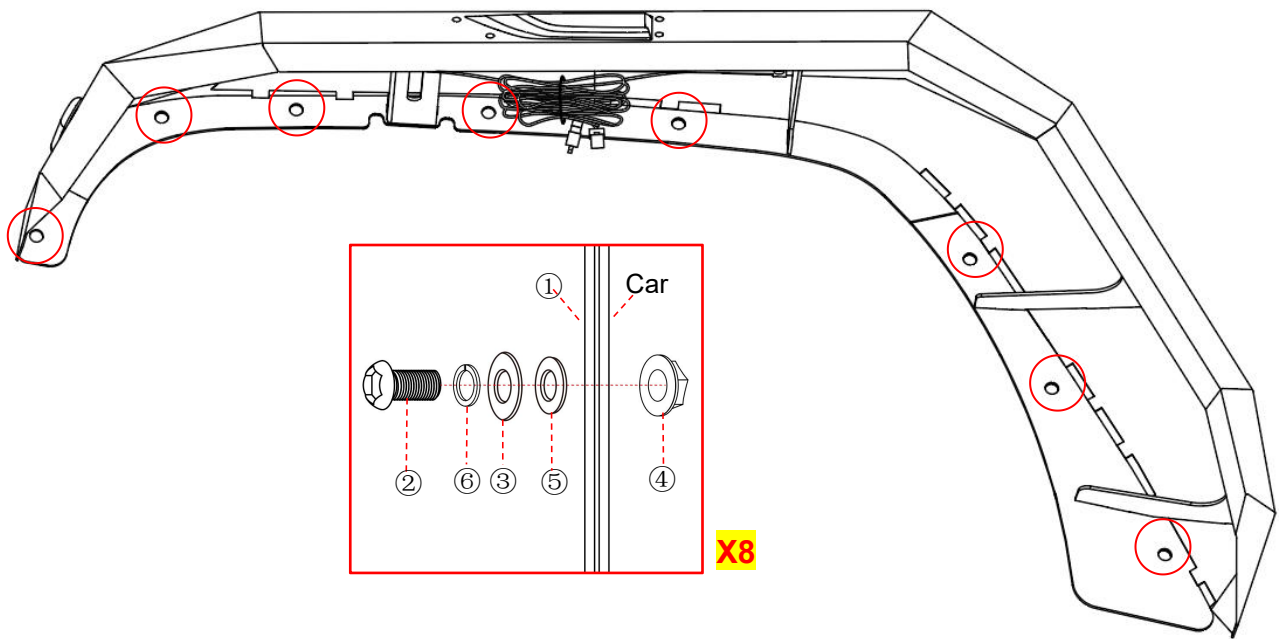

Step 5: Connect the front fender flares light wiring.

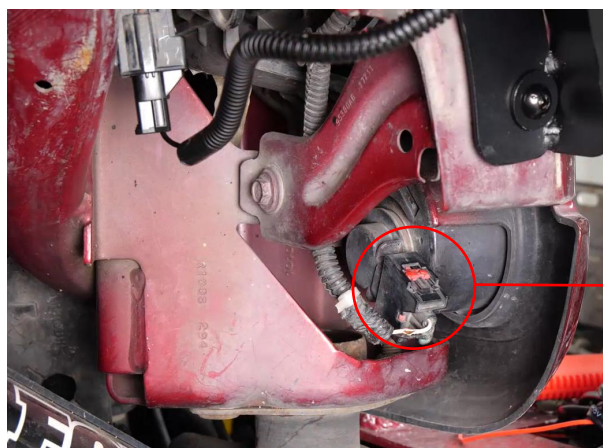
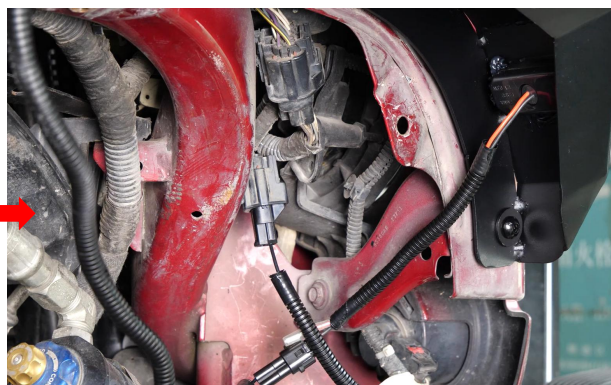
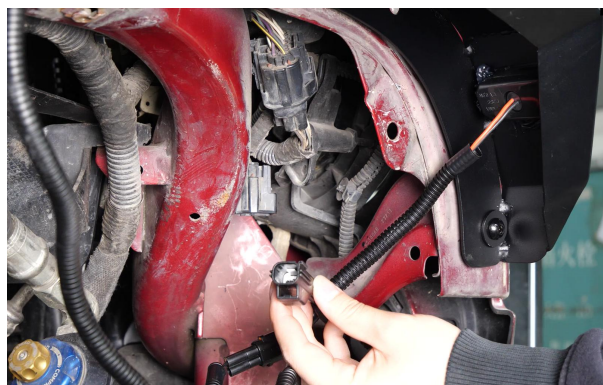
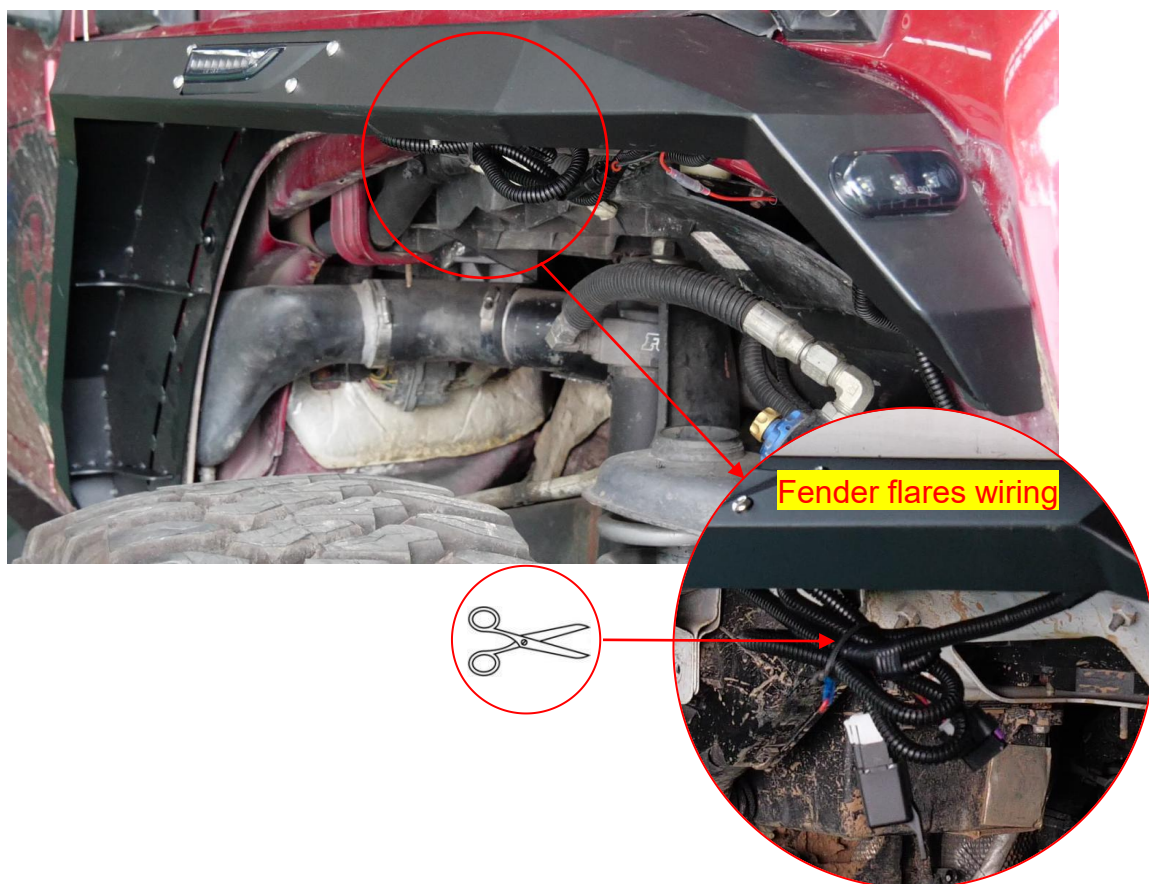

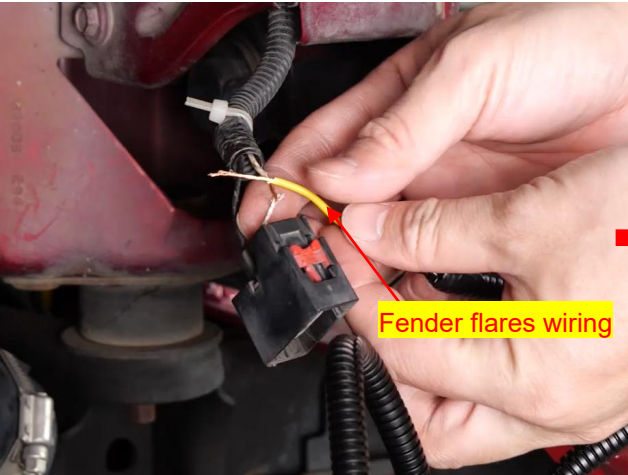

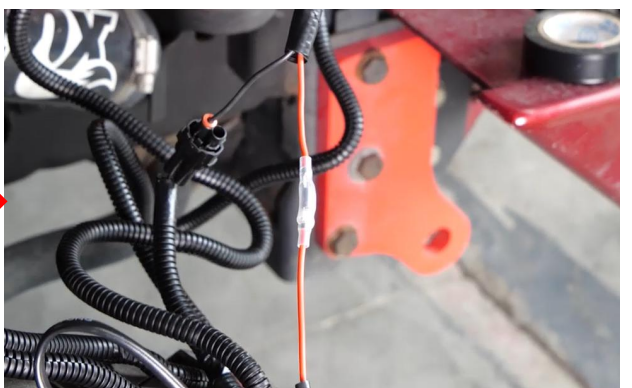
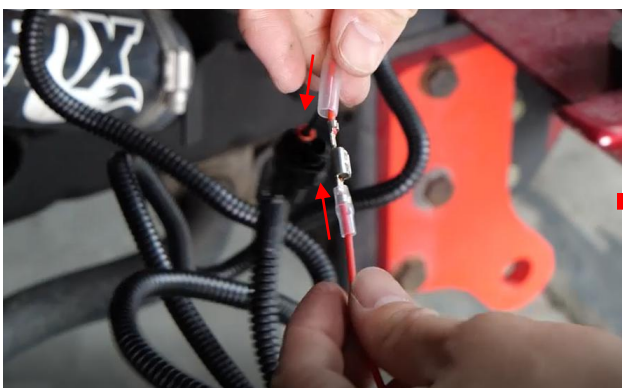
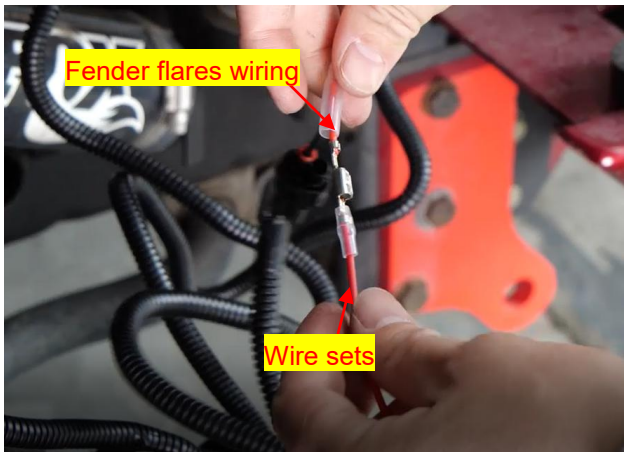
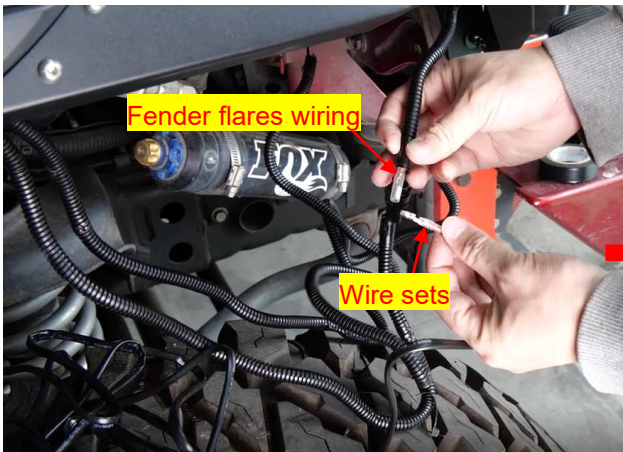
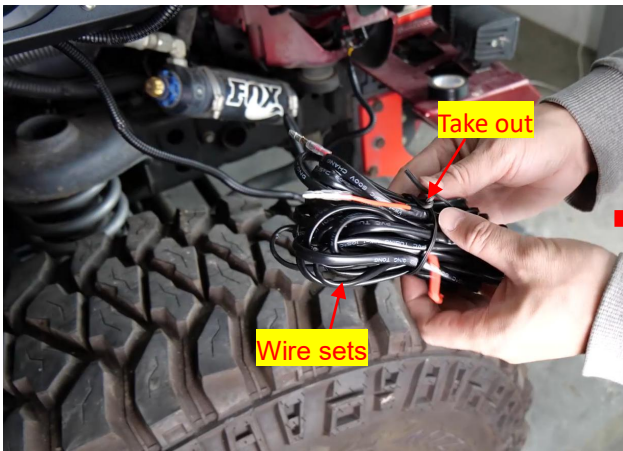
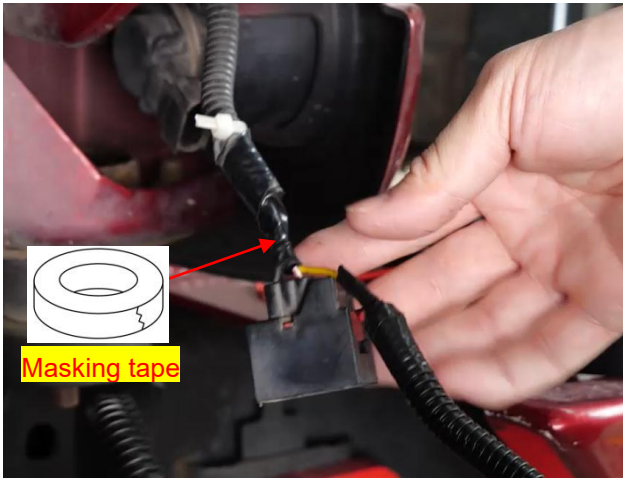

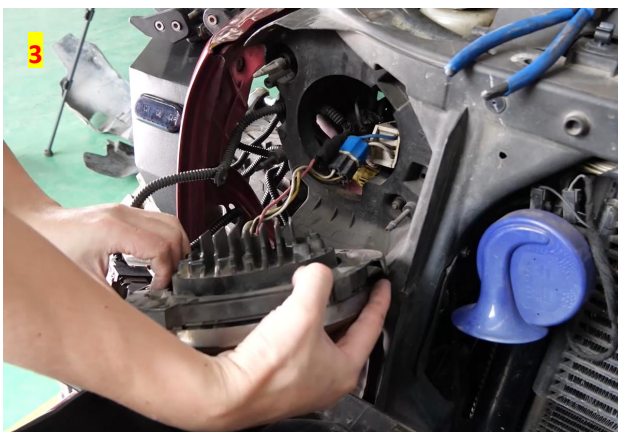
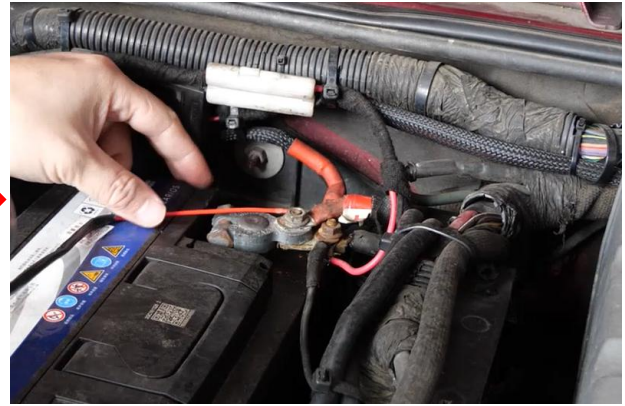

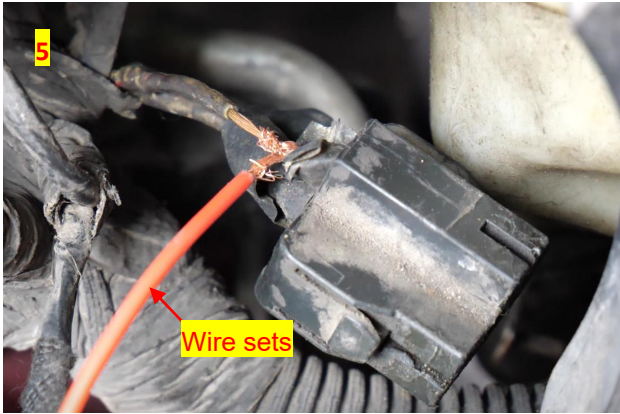

Step 6: Bundling wires.

Step 7: Installation of a front fender flares is complete. Please do periodic inspections of the fender flares to make sure that all hardware is secure and tight.

Step 8: Install all the original vehicle parts.