

REAR BUMPER

— User Manual —

2016-2023 Toyota Tacoma

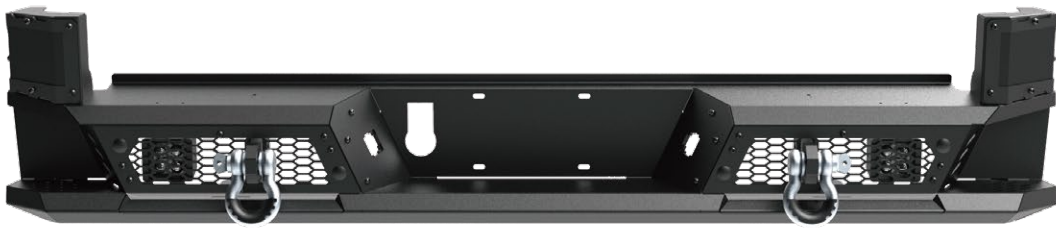

NTA01B102

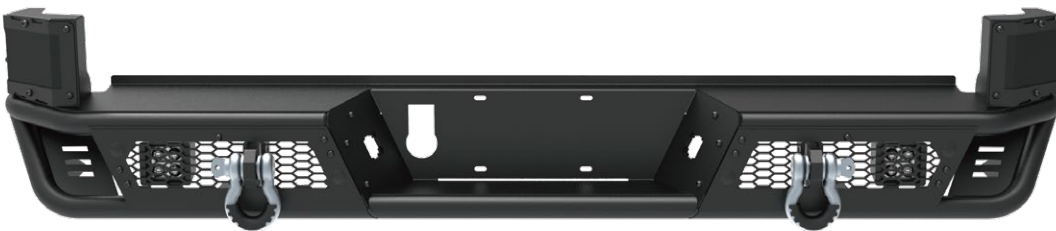

NTA01B103

Model:	NTA01B102	NTA01B103
Material:	Q235A	Q235A
Product Dimensions:	69.3 x 11.7 x 13.2 inch	69.6 x 11.9 x 12.8 inch
Package Dimensions:	30 x 25 x 10.6 inch	31.3 x 23 x 11 inch
Product Weight:	75 lbs	73 lbs

※ Thank you for purchasing the REAR BUMPER. Please read this manual carefully and keep it properly if you need to refer to it afterward. If you need any support or assistance, please contact us with your product model number and order number, and our support team will help you solve problems.



⚠ WARNING

※ This product is designed primarily to enhance the appearance of the vehicle. Do not rely in any way on the components of this product to protect against injury or death in the event of an accident. To reduce the risk of serious injury or property damage, please read all safety messages and understand all instructions and procedure notices before attempting to install or use this product.





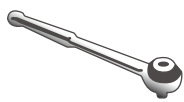
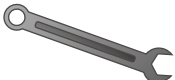

⚠ CAUTION



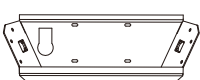
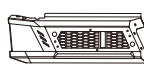
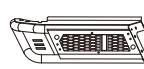



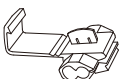

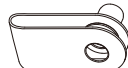

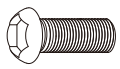
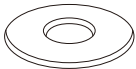

※ Properly torque and recheck fasteners and security of step tread after 250 miles and inspect frequently. Do not use if damaged.

REQUIRED TOOLS

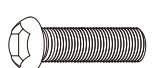
Socket 	Ratchet 	Wrench 	Allen Wrench 	Safety Glasses 
---	--	---	--	---

Parts Information

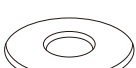
NO.		Parts Name	Size	Line Graph	Qty	Color
①	/	Mid Bumper	/		1	Black
②	102	Side Wings	/		1	Black
	103		/			
③	/	BSM Cover	/		1	Black
④	/	Trailer Hitch	/		2	Black
⑤	/	Led lights	4inch		2	/
⑥	/	Cable Wires	2x0.75mm		2	/
⑦	/	Wire Connector Clips	/		8	/
⑧	/	Shackles	/		2	Black
⑨	/	Zip ties	/		10	Black
⑩	N33	Clamping Nuts	M6		7	Color zinc plating

NO.		Parts Name	Size	Line Graph	Qty	Color
⑪	B07	Half Head Allen Bolts	M6x20		7	Dacro Black
⑫	W13	Flat Washer	Φ6x18x1		7	Dacro Black
⑬	B74	Half Head Allen Bolts	M6x35		5	Dacro Black
⑭	N11	Hex Lock Nuts	M6		5	Dacro Black
⑮	B35	Hex Bolts	M10x35		5	Dacro Black
⑯	W22	Spring Washer	Φ10		5	Dacro Black
⑰	W23	Flat Washer	Φ10x25x2		9	Dacro Black
⑱	N15	Hex Nuts	M10		5	Dacro Black
⑲	B15	Half Head Allen Bolts	M8x20		13	Dacro Black
⑳	N14	Hex Flange Nuts	M8		13	Dacro Black
㉑	B77	Hex Bolts	M12x55		5	Dacro Black
㉒	W25	Spring Washer	Φ12		5	Dacro Black
㉓	W27	Flat Washer	Φ12x30x3		9	Dacro Black
㉔	N19	Hex Nuts	M12		5	Dacro Black

Note:

Spare parts such as N33、B07、W13、B74、N11、B35、W22、W23、N15、B15、B77、N14、W25、W27 and N19 are provided with 1PCS each (included in the number of parts details).

Installation Instructions

※ **Note:** This installation manual takes one of the models as an example.

Step 1: Open the carton and take out the parts. Check whether the number of components is complete.

Step 2: Remove the original bumper and prepare the parts needed to install the bumper.

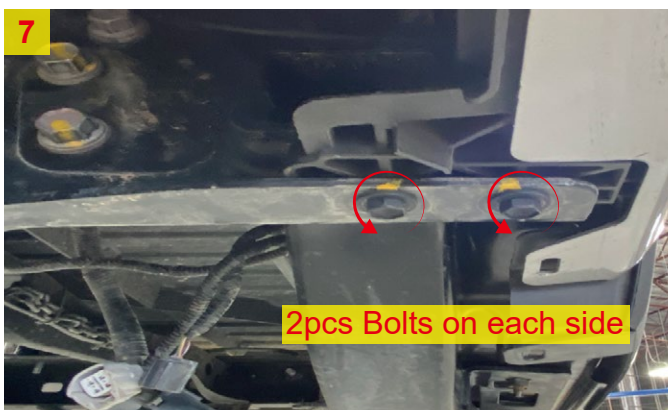
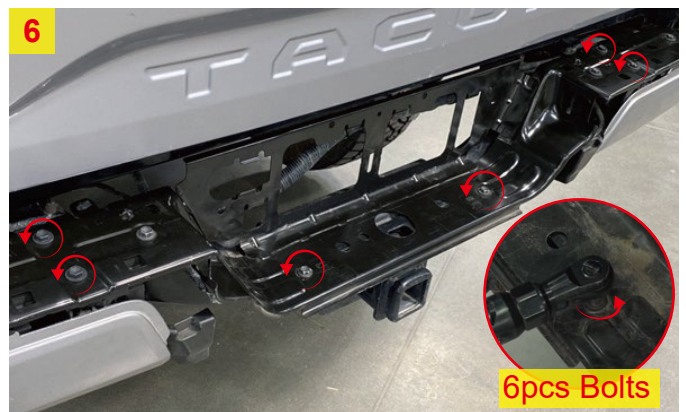
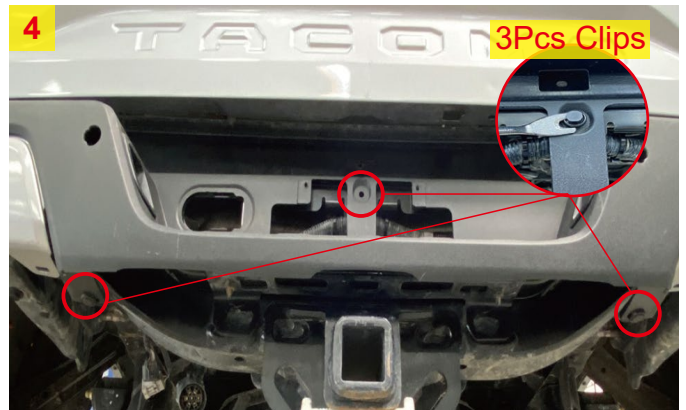

Step 3: Install the BSM Cover.

If your vehicle is equipped with Blind Spot Monitor Sensors, disconnect the sensor from the wire harness by pressing the tab of the connector and pulling outwards. Using a 10mm Socket, remove the 3X nuts securing the sensor to the bumper shell and set aside. Repeat this step on Passenger side.

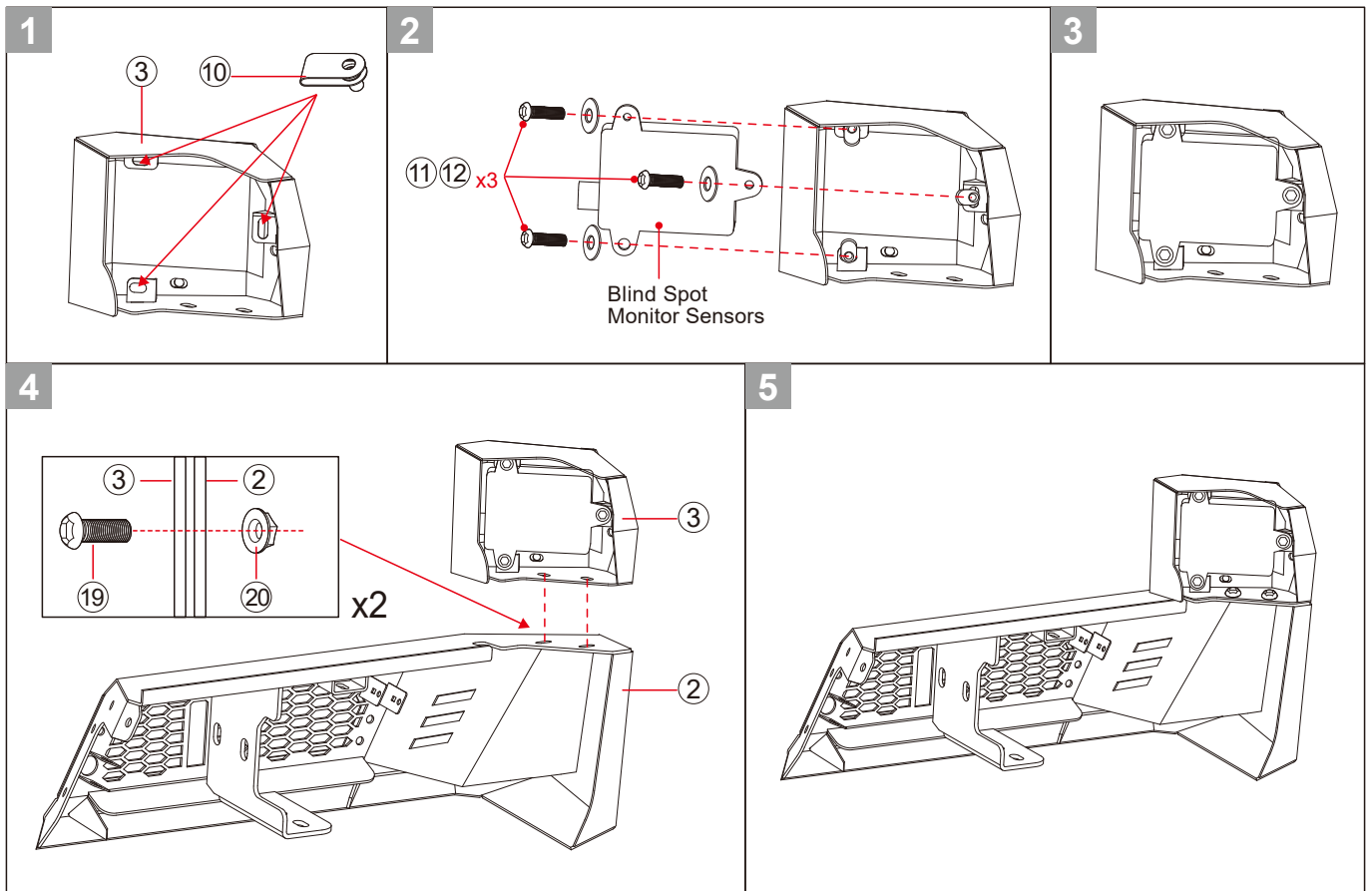
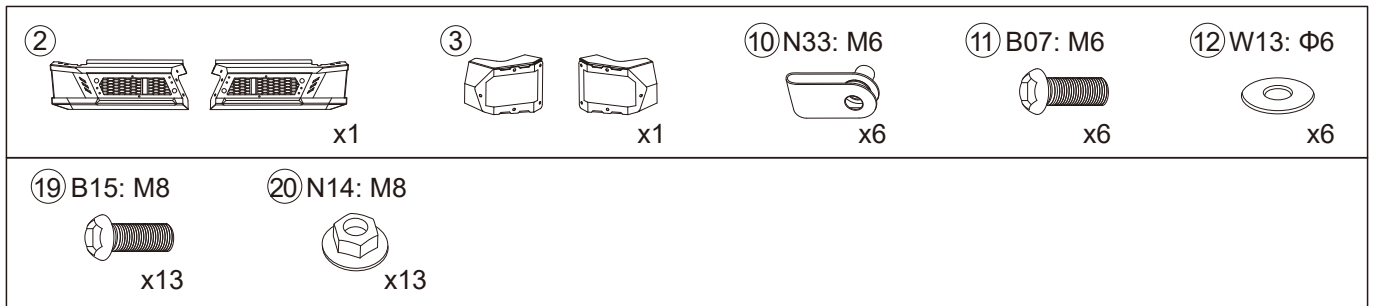
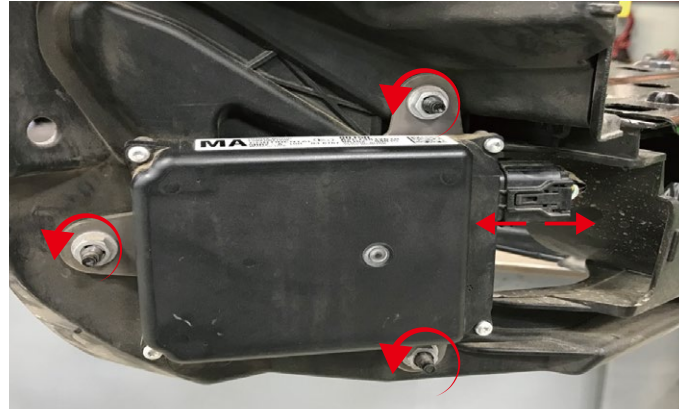

Step 4: Splicing the rear bumper.

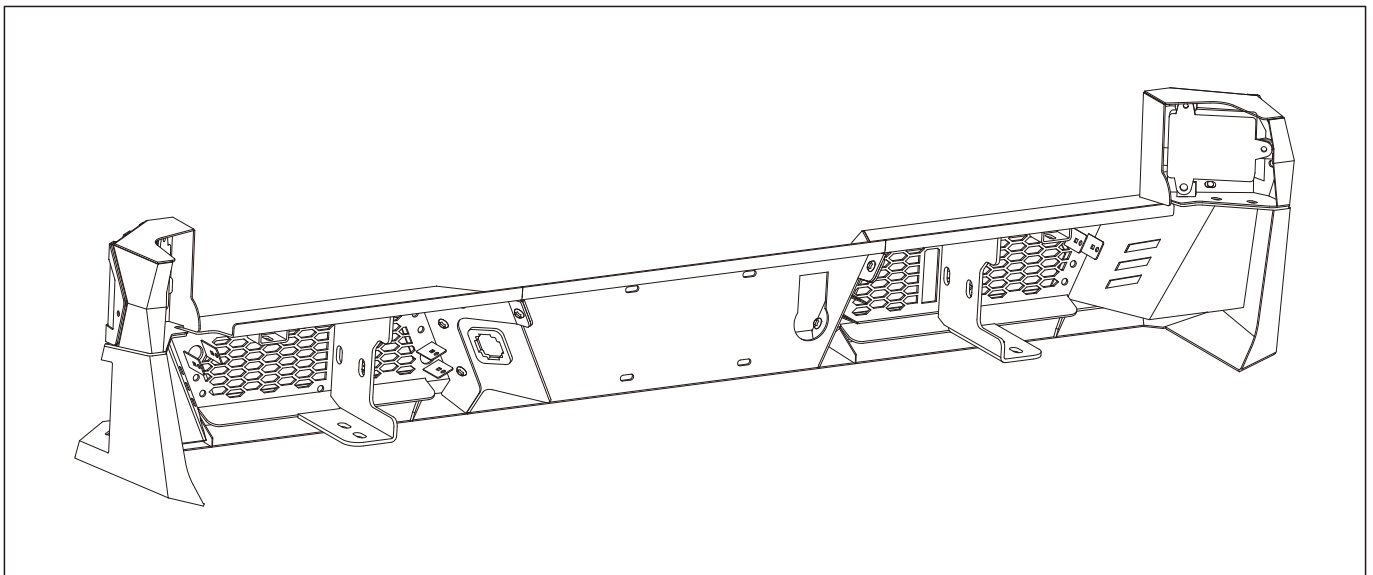
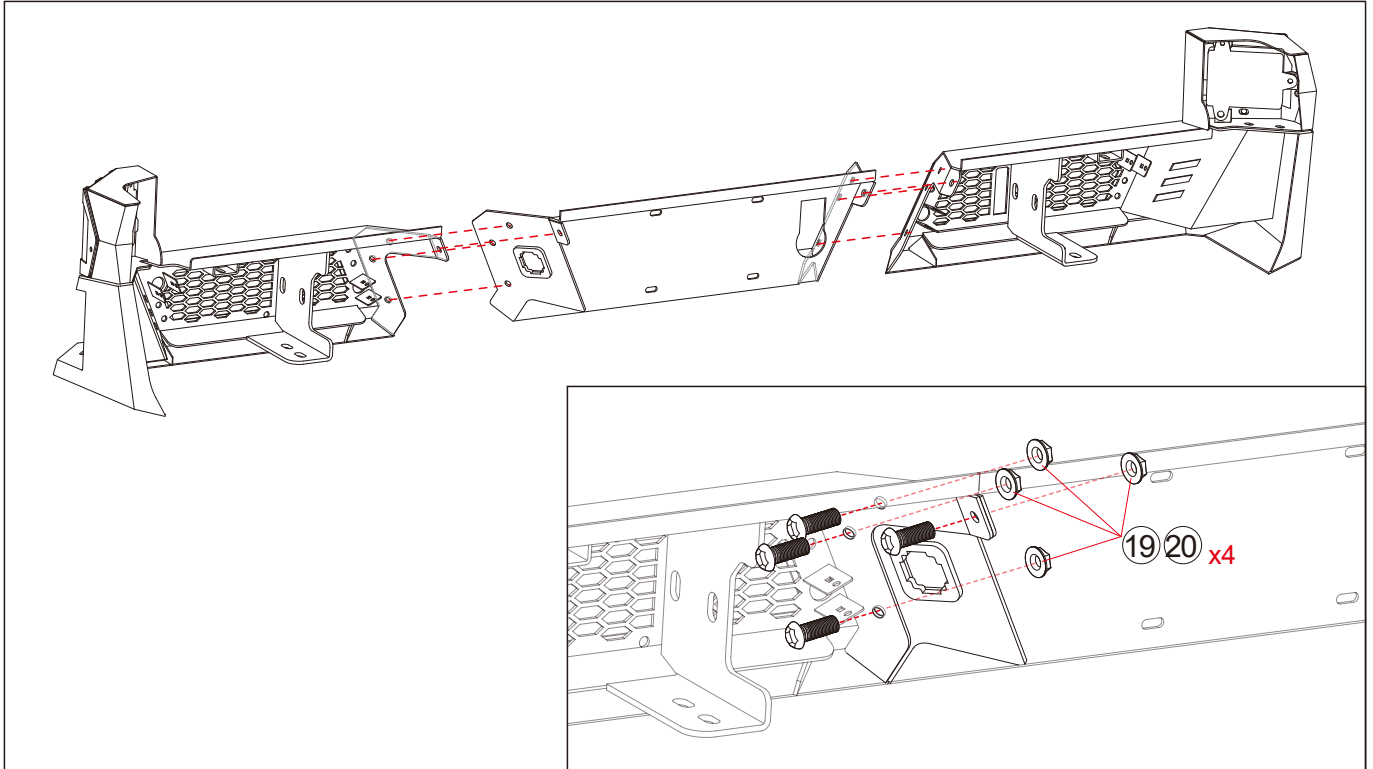

Step 5: Install the ⑤ 4 Inch Ledlight.

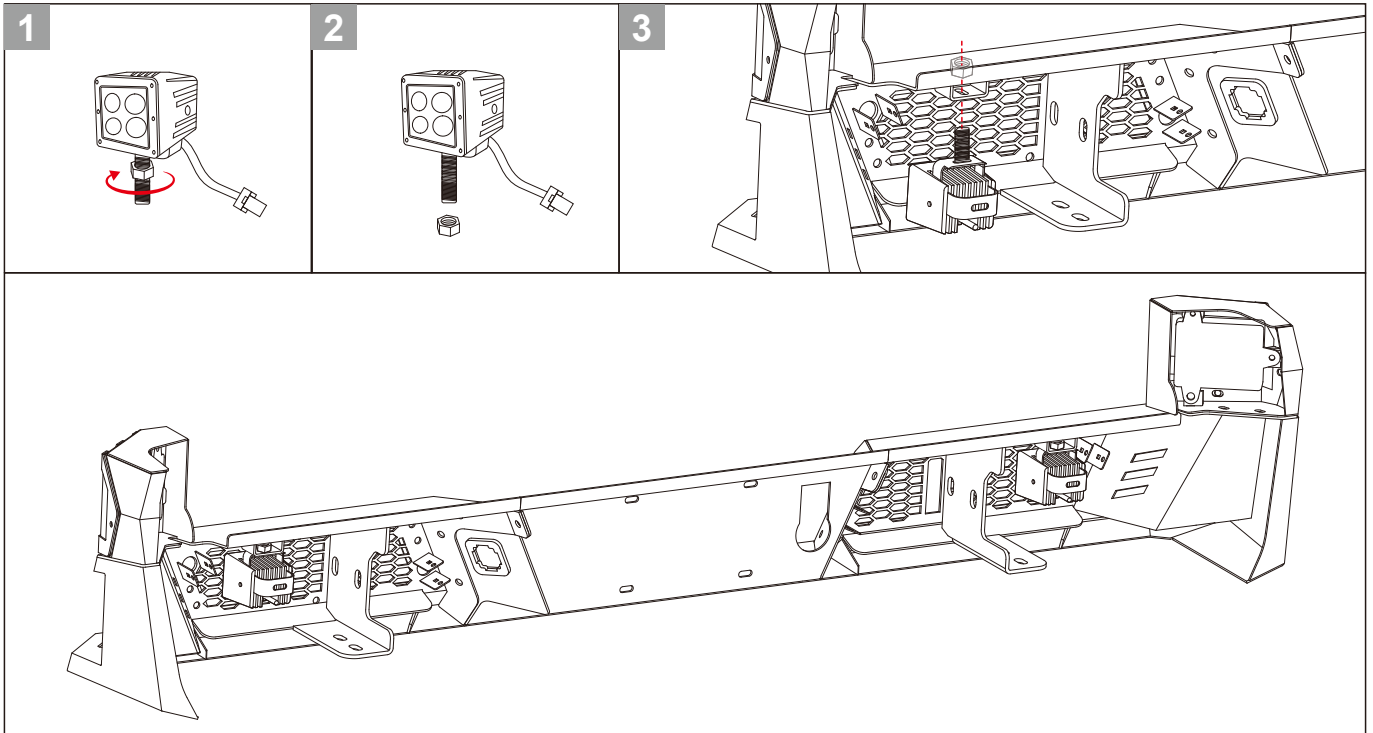

Step 6: Connect the Trailer plug wiring, 4inch Led lights and ⑥ Cabel wires.

7-Way Connector Wiring/Function Diagram

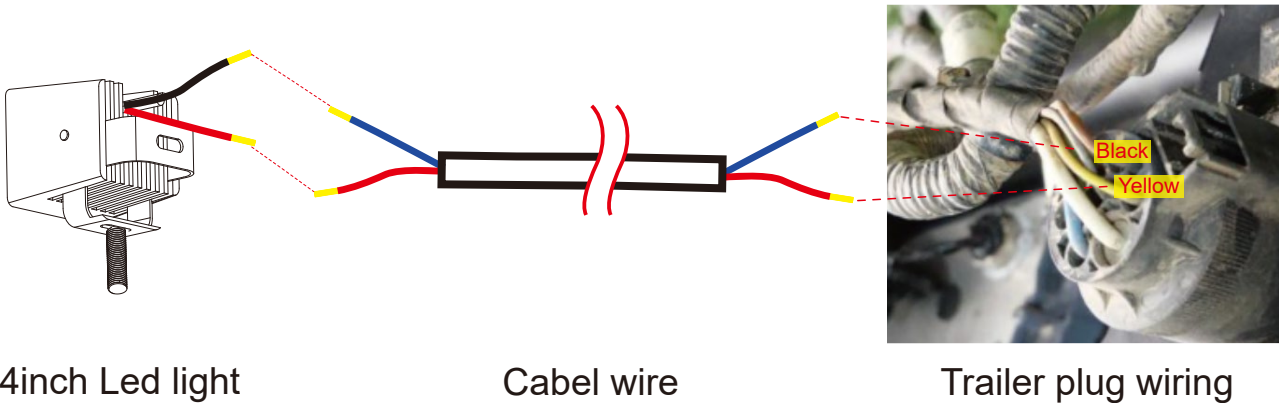
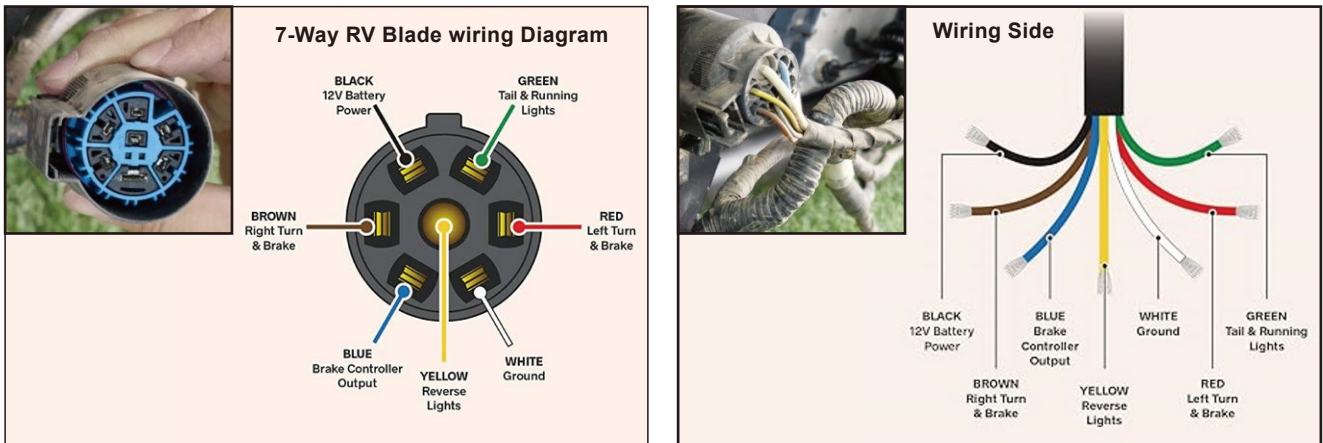

Step 7: Install the Trailer Hitch.

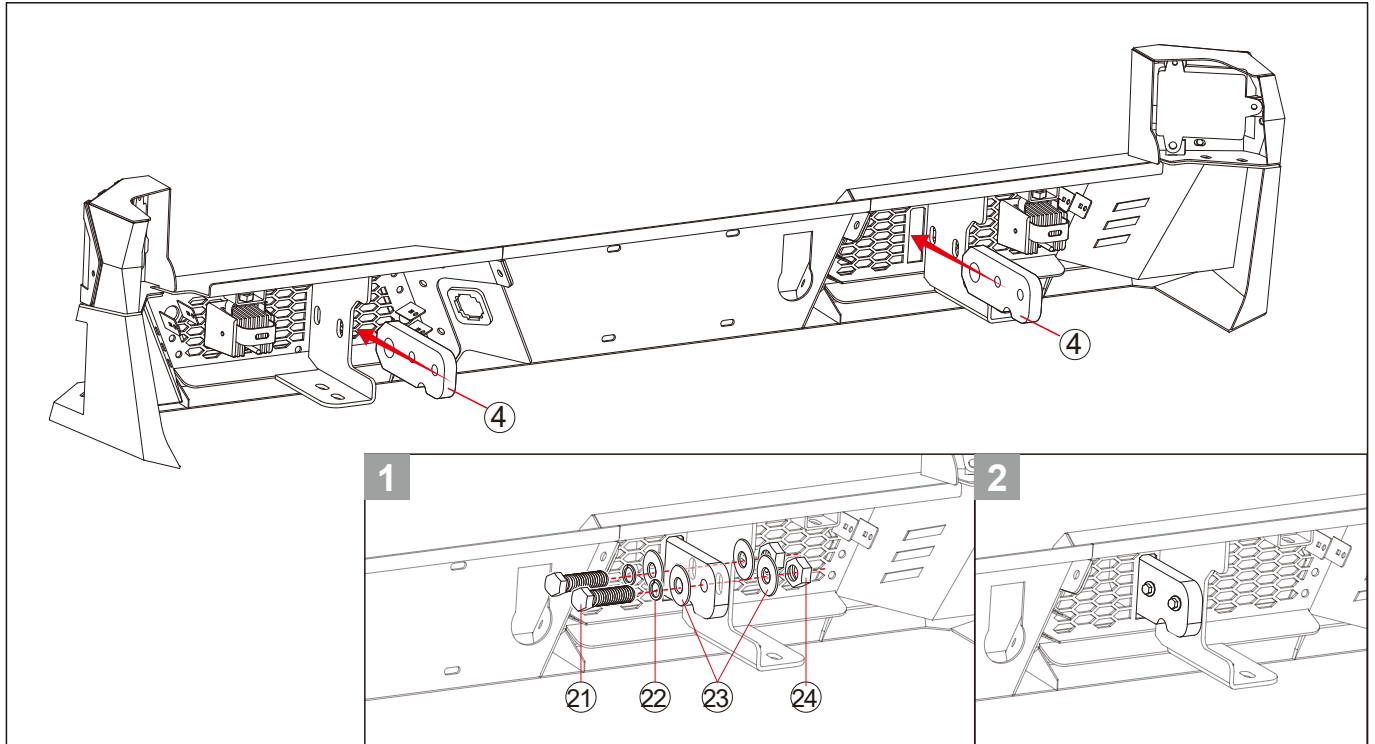
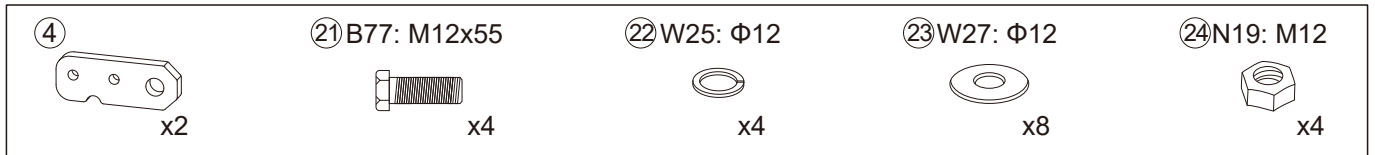

Step 8: Install the Shackles.

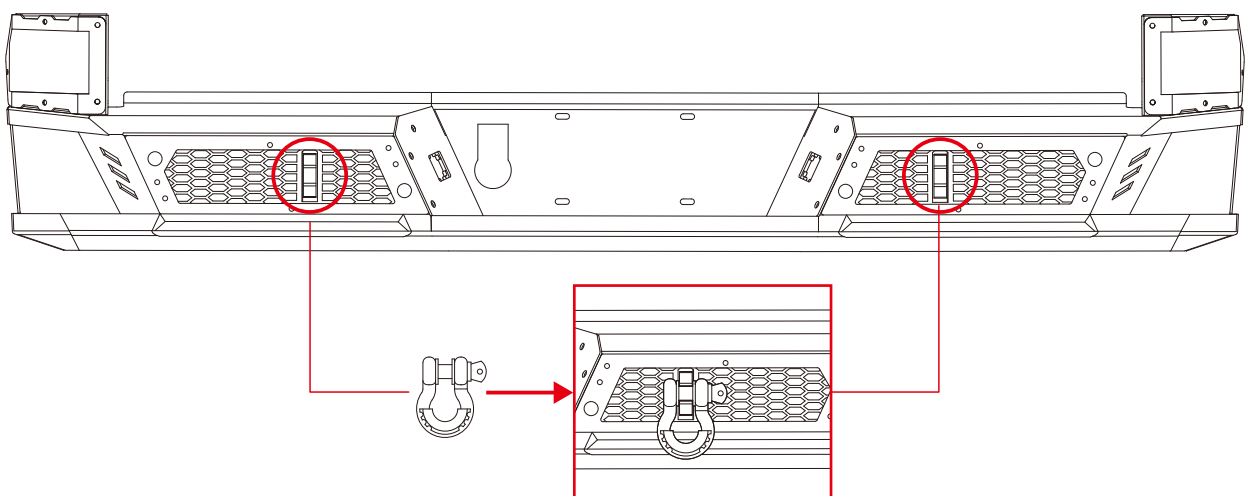

Step 9: Install the Radar Probe.

Note: If the car does not have a radar probe, this step can be ignored.

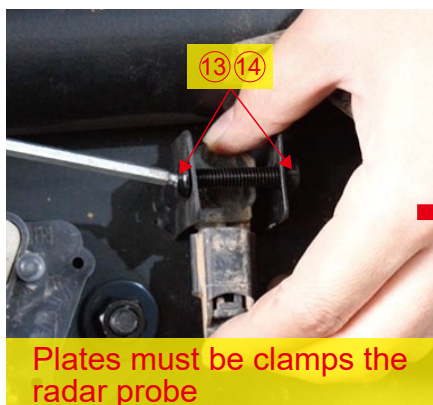
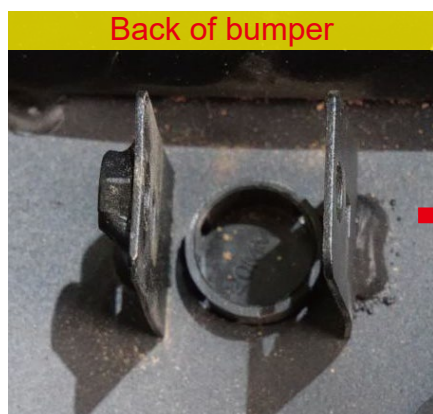
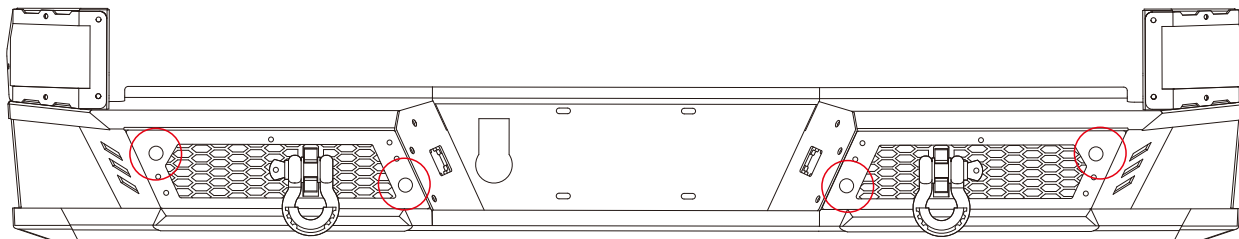

Step 10: Install the Rear Bumper.

