

FRONT BUMPER

————— User Manual —————

2016-2023 Toyota Tacoma

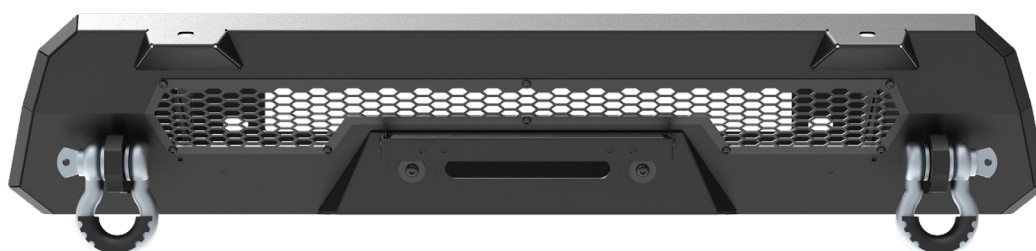

Model:	NTA01A103-1A
Material:	Q235A
Product Dimensions:	46.4 x 12.68 x 8.6 inch
Package Dimensions:	50 x 13.77 x 11.8 inch
Product Weight:	66.1 lbs

※ Thank you for purchasing the FRONT BUMPER. Please read this manual carefully and keep it properly if you need to refer to it afterward. If you need any support or assistance, please contact us with your product model number and order number, and our support team will help you solve problems.

⚠ WARNING

※ This product is designed primarily to enhance the appearance of the vehicle. Do not rely in any way on the components of this product to protect against injury or death in the event of an accident. To reduce the risk of serious injury or property damage, please read all safety messages and understand all instructions and procedure notices before attempting to install or use this product.

⚠ CAUTION

※ Properly torque and recheck fasteners and security of step tread after 250 miles and inspect frequently. Do not use if damaged.

REQUIRED TOOLS				
Socket 	Ratchet 	Wrench 	Safety Glasses 	Flathead Screwdriver 
Ruler 	Angle Grinder 	Side Cutter 	Needle-Nose Pliers 	Panel Remover 
Power Cutting Tool 	Painter's tape 	Marker 	Tape Measure 	

Parts Information

	NO.	Parts Name	Size	Line Graph	Qty	Color
①	/	Bumper	/		1	Black
②	/	Barrect L & R	/		1	Black
③	/	License Bracket	/		1	Black
④	/	Shackles	/		2	Blue Zinc Plating
⑤	/	Plate 1	31x89		1	Black
⑥	/	Plate 2	32x71		1	Black
⑦	/	U-Rubber Strip	2.6m		1	PVC
⑧	N19	Hex Nuts	M12		3	Dacro Black
⑨	W27	Flat Washer	Φ12x30x3		13	Dacro Black
⑩	W25	Spring Washer	Φ12		3	Dacro Black
⑪	B37	Hex Bolts	M12x35		3	Dacro Black
⑫	B20	Hex Bolts	M8x25		5	Dacro Black
⑬	N22	Hex Nuts	M8		5	Dacro Black
⑭	W16	Spring Washer	Φ8		5	Dacro Black
⑮	W43	Flat Washer	Φ8x20x2		7	Dacro Black

※ Note: spare parts such as N19、W27、W25、B27、B20、W16 and W43 are provided with 1PCS each (included in the number of parts details).

Installation Instructions

Step 1: Open the carton and take out the parts. Check whether the number of components is complete.

Step 2: Remove the original bumper and prepare the parts needed to install the bumper.

Step 3: Take off the air dam.

Note: If the car does not have air dam, this step can be ignored.



1. Unscrews the front wheel of the inside each.

NOTE: Turned the tire out to give yourself some space.

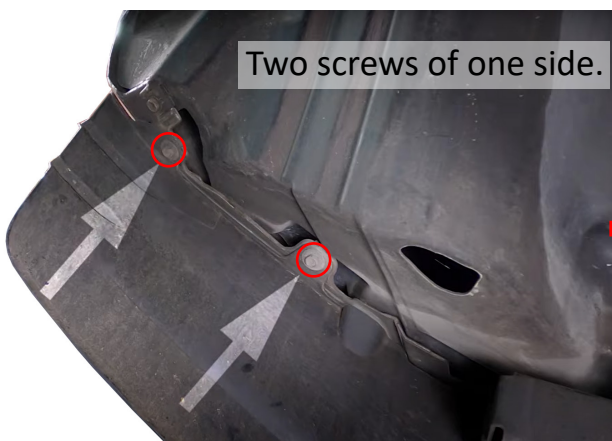

Repeat that on the other side.

2. Unscrews under neathe the front of this plastic chin.

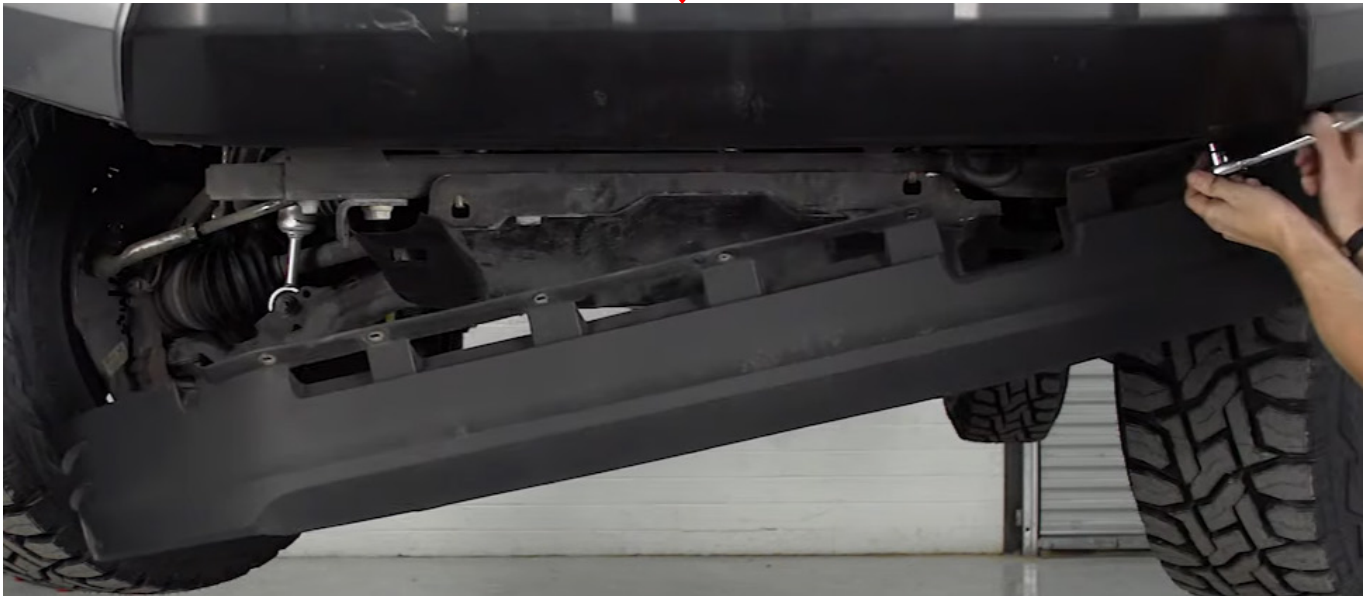
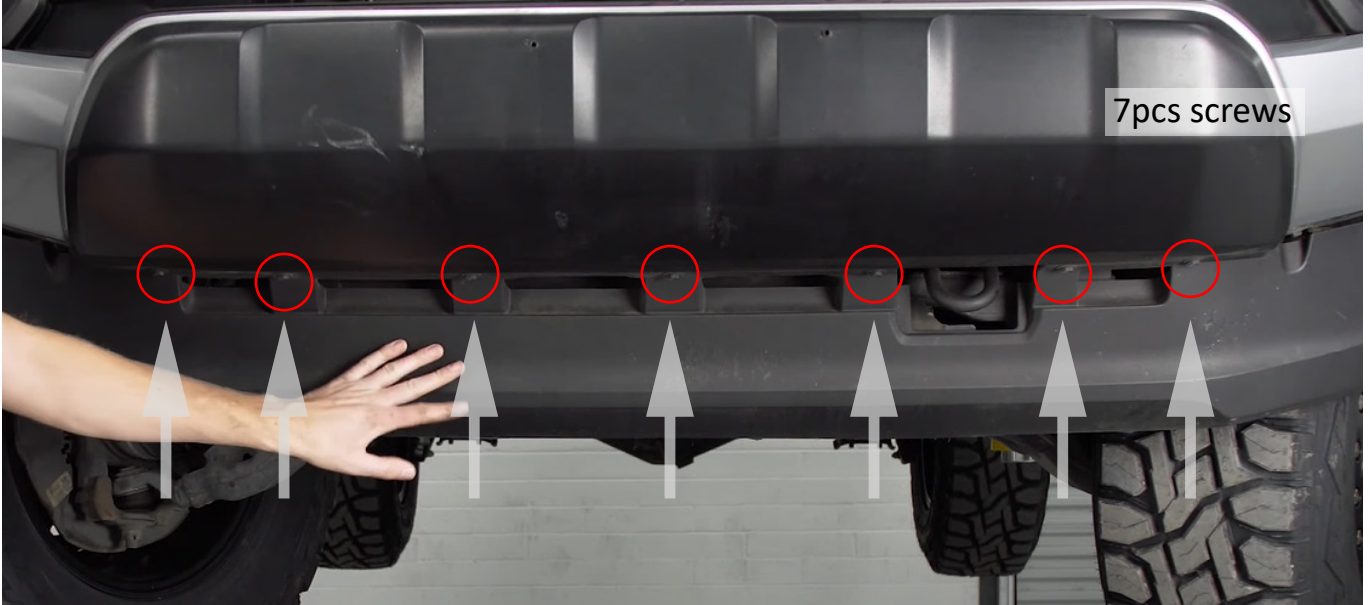

Step 4: Remove the original bumper.

Grab this front plastic trim part underneath and it since not reusing it anyways.

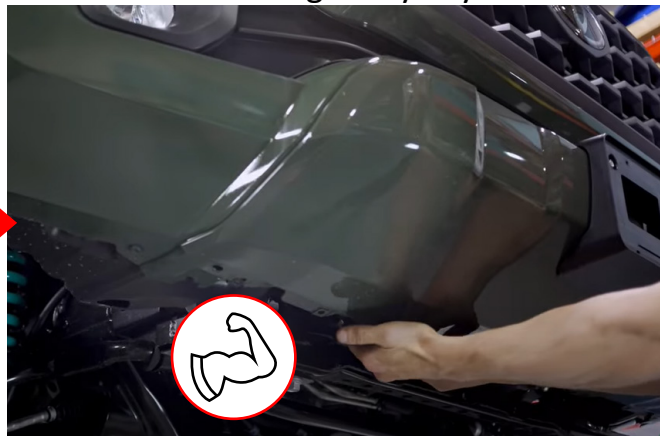

Step 5: Cut out the trim piece.

1. Make a mark and cut out the trim piece.

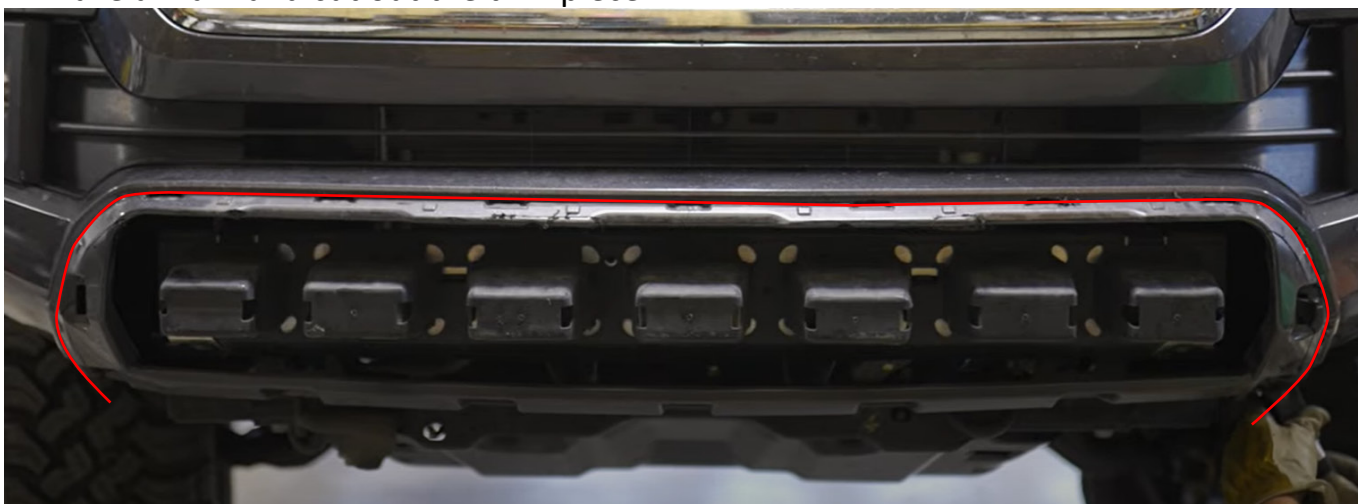

The trim piece has been cut out.

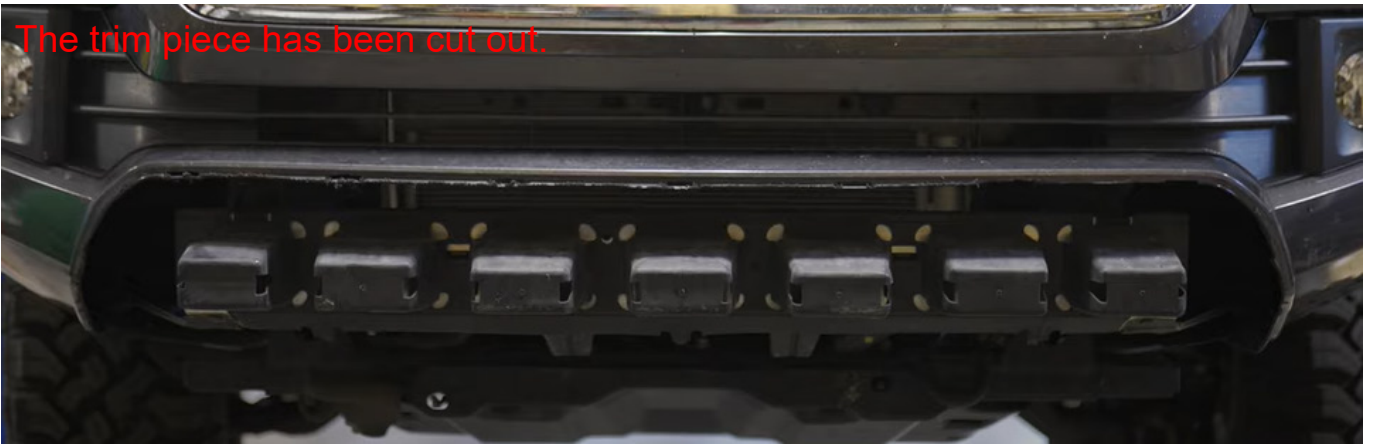

2. Remove this plastic piece on our crash bar.
Tips: It's just held in by a couple of clips so you just have to depress, and discarded it.



3. sanding it and clean up some of these edges.



Step 6: Install the ⑦ U-rubber strip.



Step 7: Remove the aluminum crash.

1. Loose the 6pcs bolts.

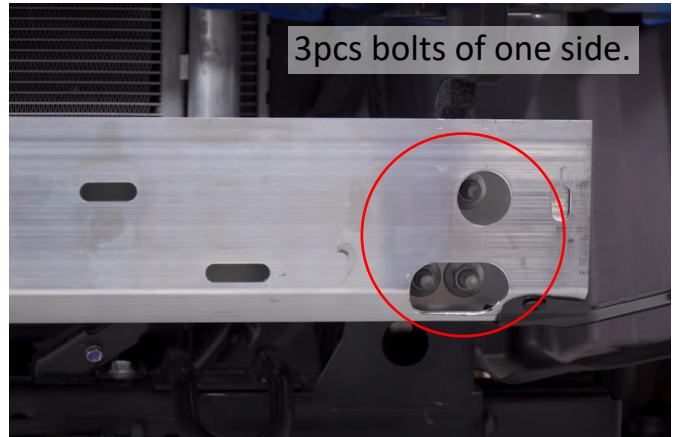
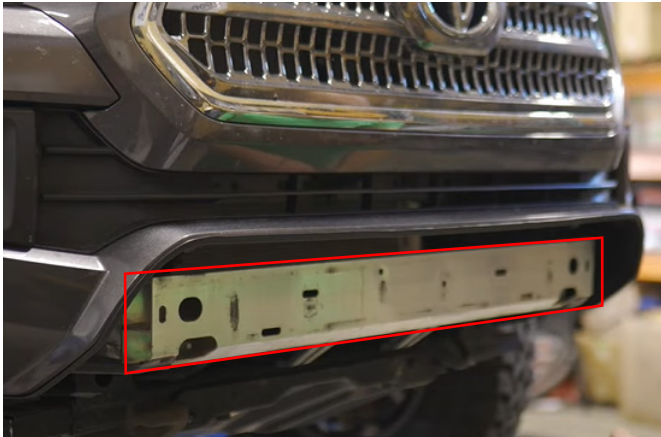

2. Loose 1pc bolt on each underside.



3. Move out the aluminum crash.

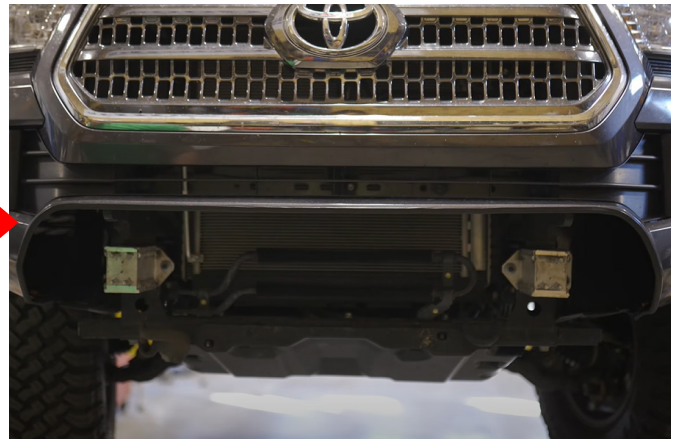
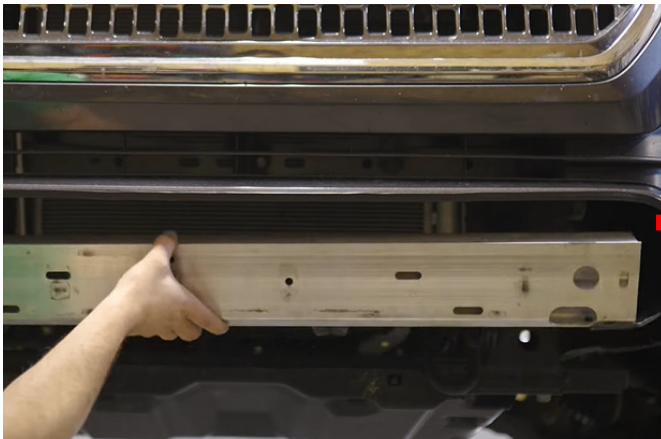

Step 8: Remove the aluminum crash bar mounting brackets.



Step 9: Remove the two frame end caps and one tow hook.

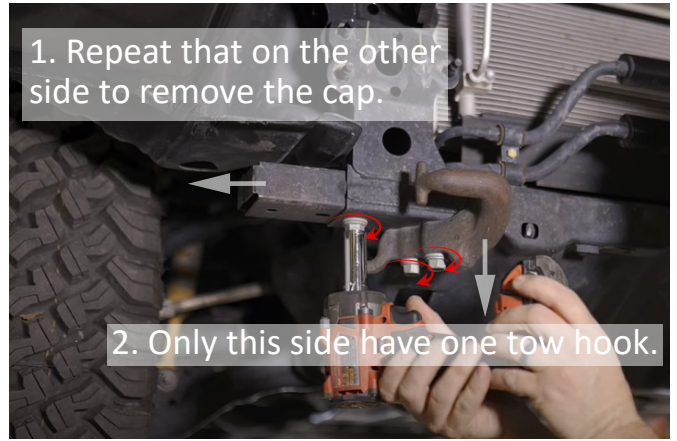
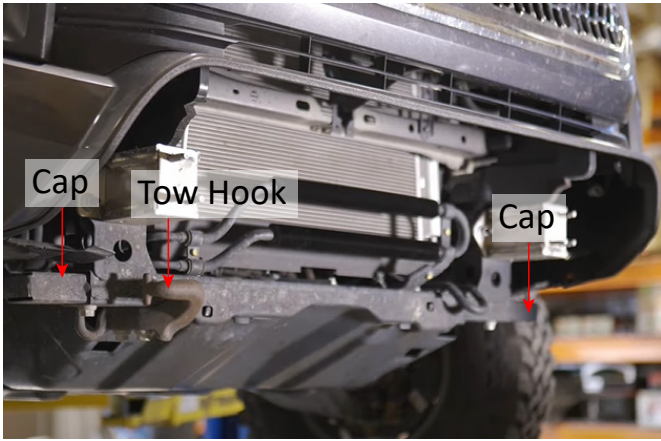

Step 10: Remove the skip plate.

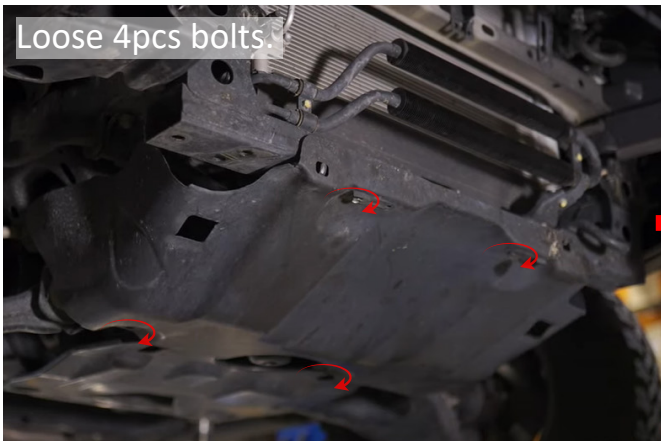

Step 11: Cut the little plastic pieces off.

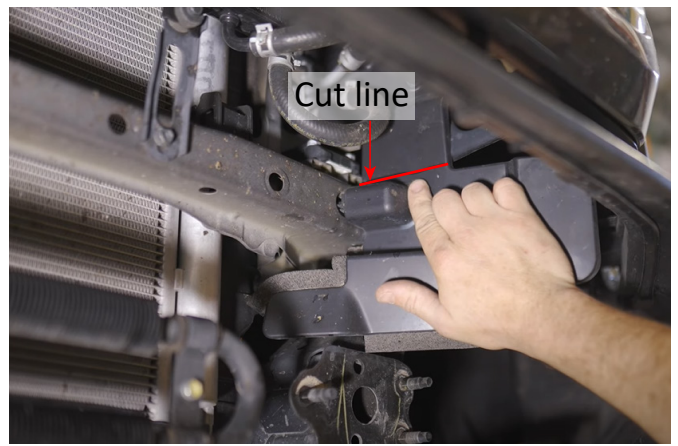
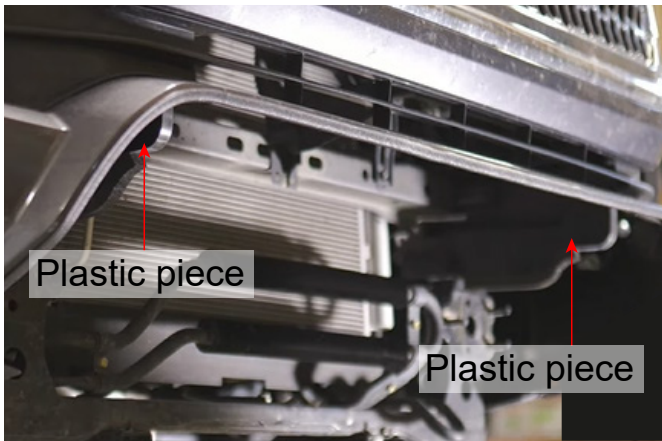

Use the power cutting tool cut up on that line be careful.



Repeat that to the other side.

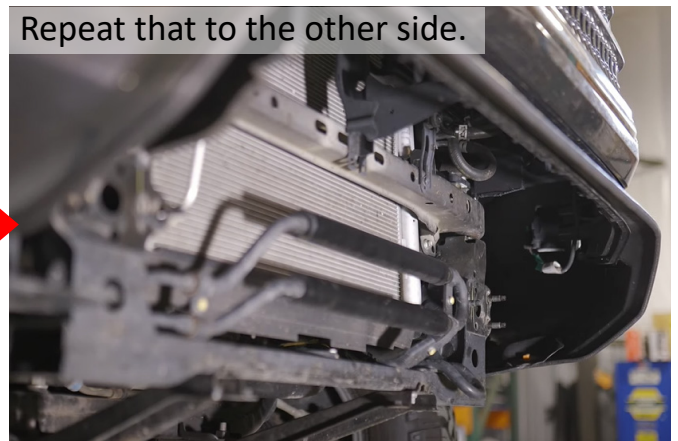

Step 12: Remove 2pcs 12mm bolts on this power steering cooler, 1pcs bolt around the corner on the top of the frame.

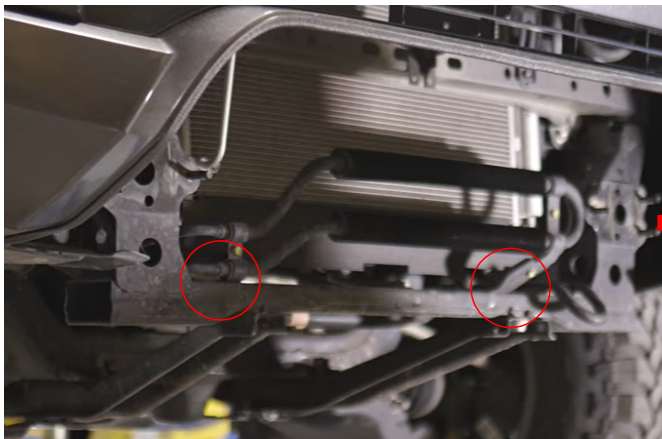

Step 13: Remove 2pcs 14mm bolts on each side, let the sway bar move down.

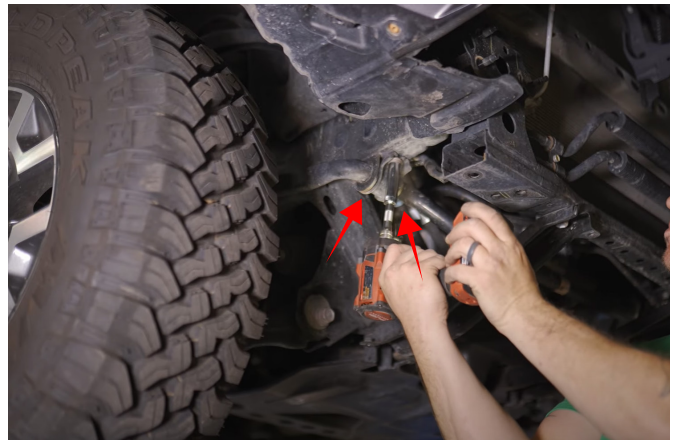
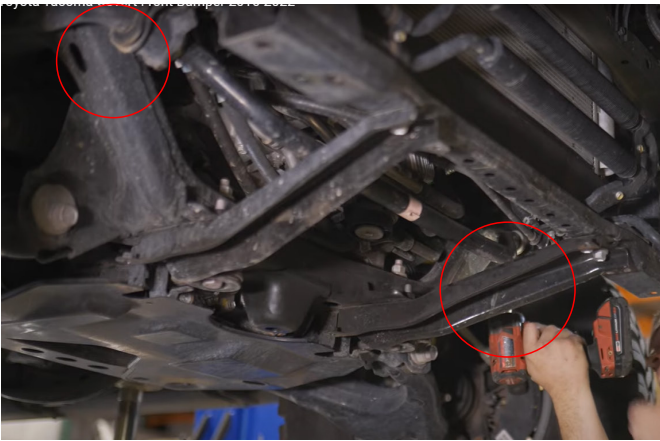

Step 14: Install our 2pcs relocation plates that move the cooler toward the inside.

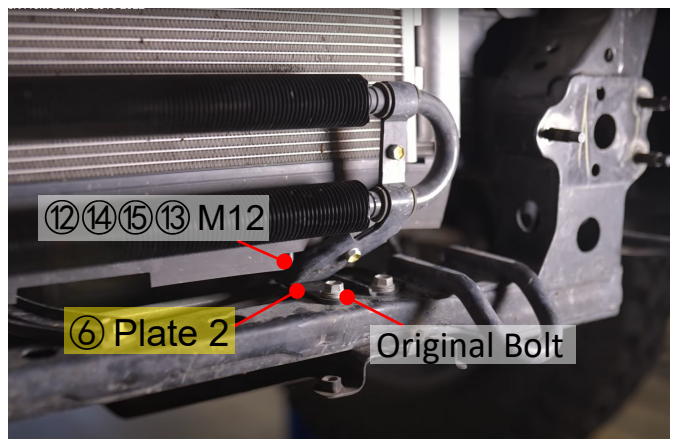
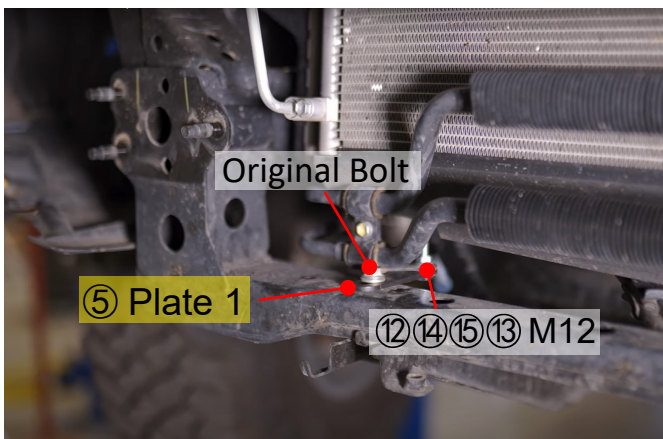
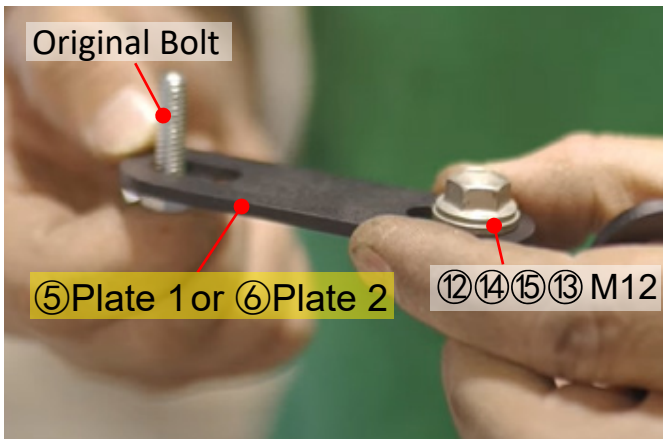

Step 15: Remove the upper grille.

1. Open the hood. Tighten out the 2pcs bolts as shown.

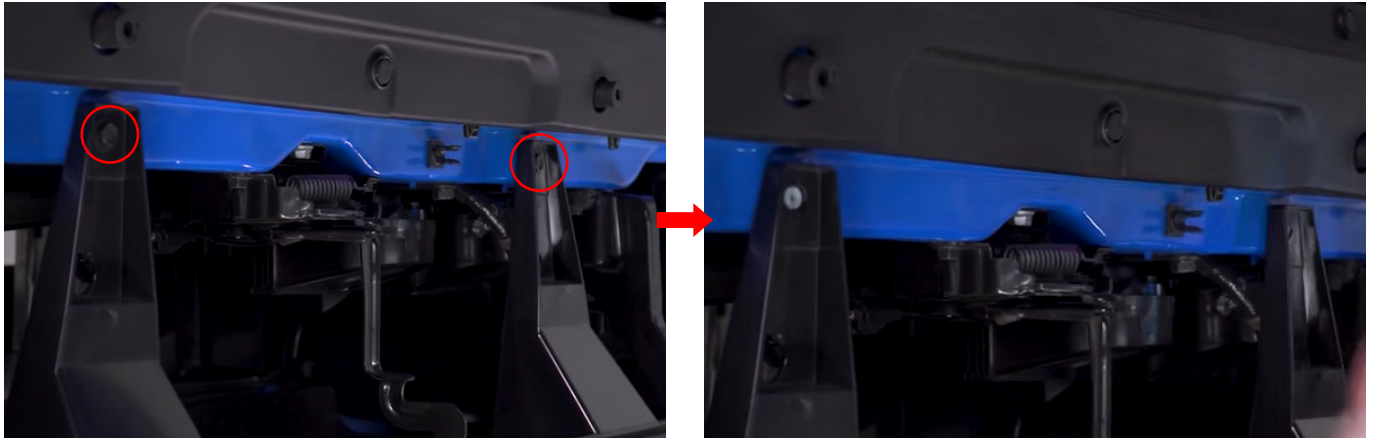

2. Take off the 2pcs clips on either side of the grille.

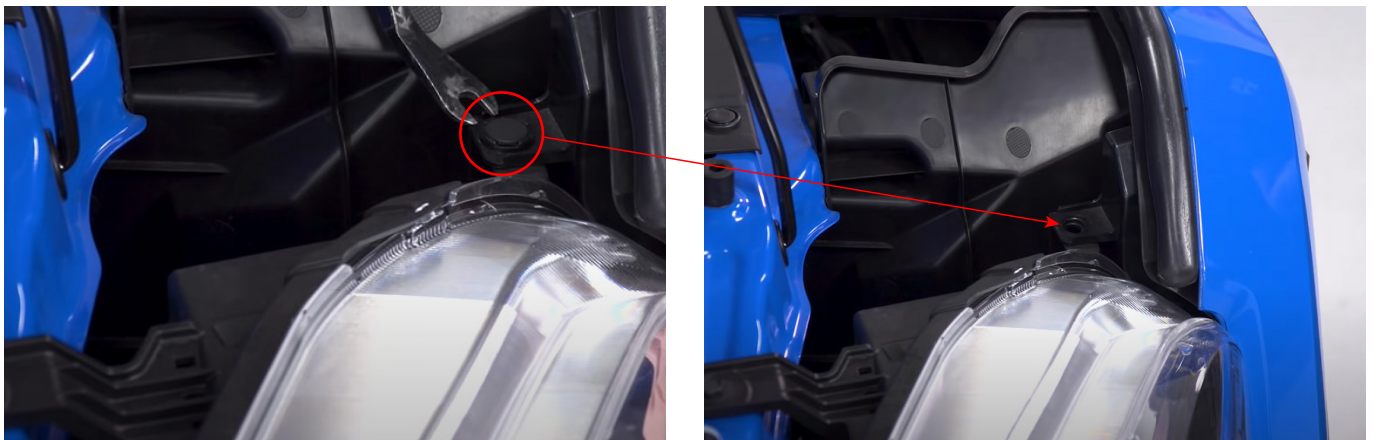

3. There is a wiring harness connected to the body from the grille here. Disconnect the plug of the wiring harness. Remove these 2pcs clips so you can pull it away from the grille and disconnect it up the plug.

Note: If the car does not have wiring harness(Model for TRD), this step can be ignored.

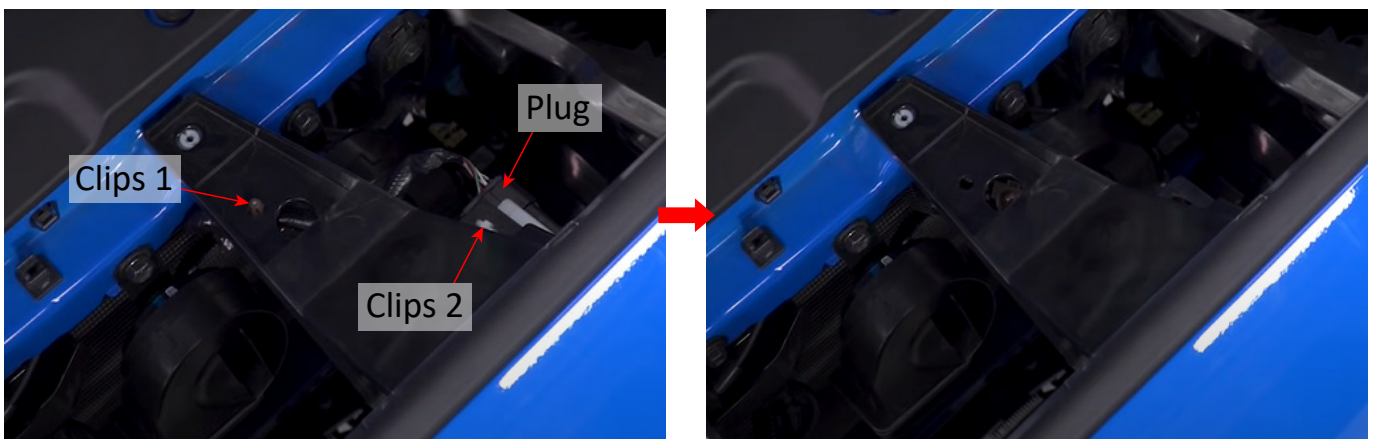

Tips: There's a little bit easier to pinch the clip with pair of needle nose and push down.

Pick up the plug and diconnect it.

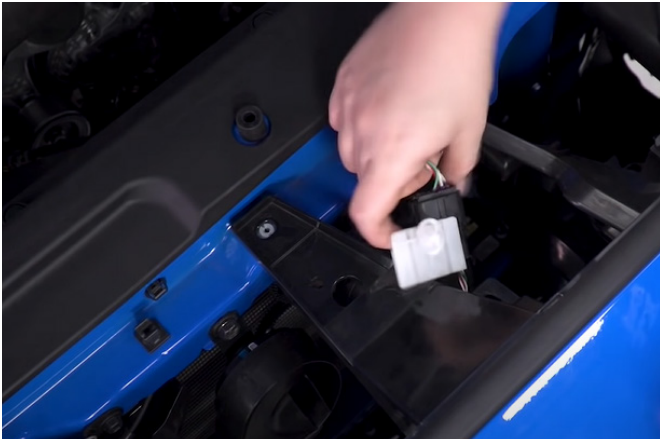

lift up on these 2 arms



Pull it back, and there's a couple of clips

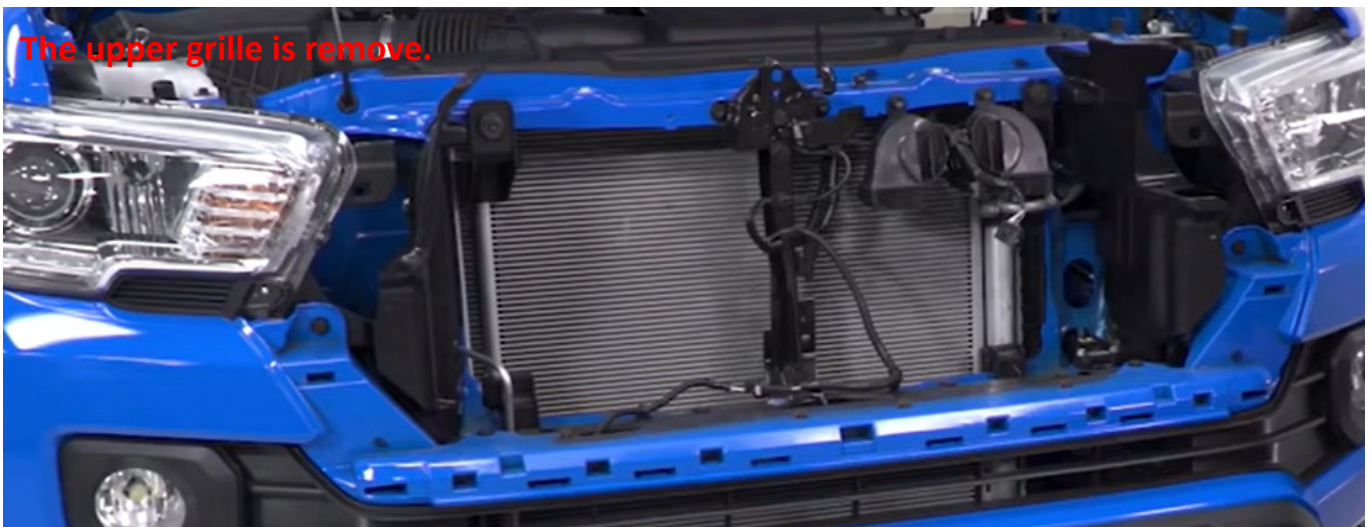
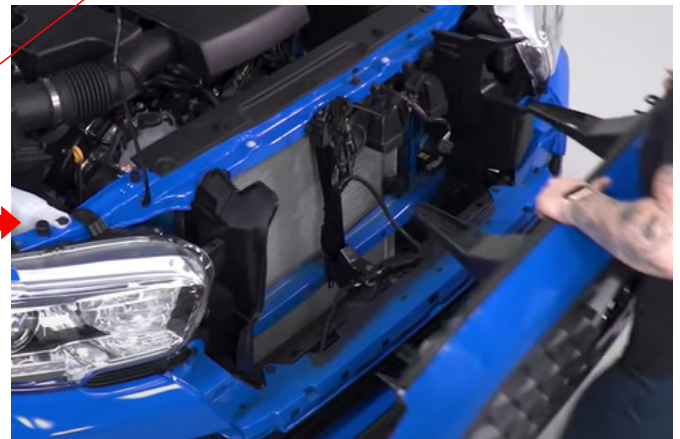

The upper grille is remove.

Step 16: Mounting the New Bumper.

1. Disassemble the bumper and winch bracket.

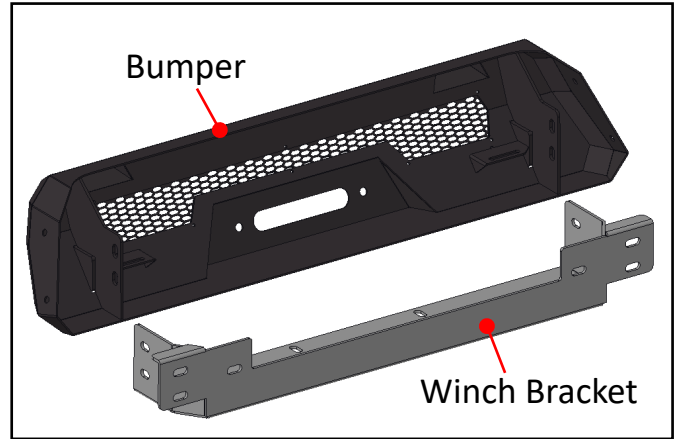
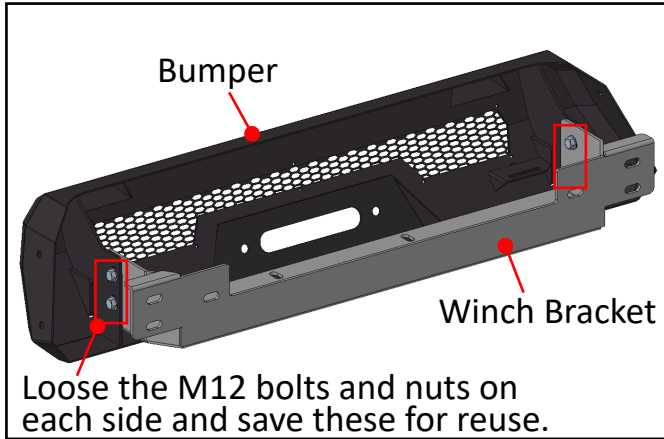

2. Mounting the winch bracket on the car of the original nuts.

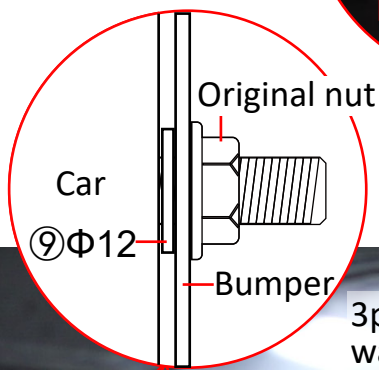
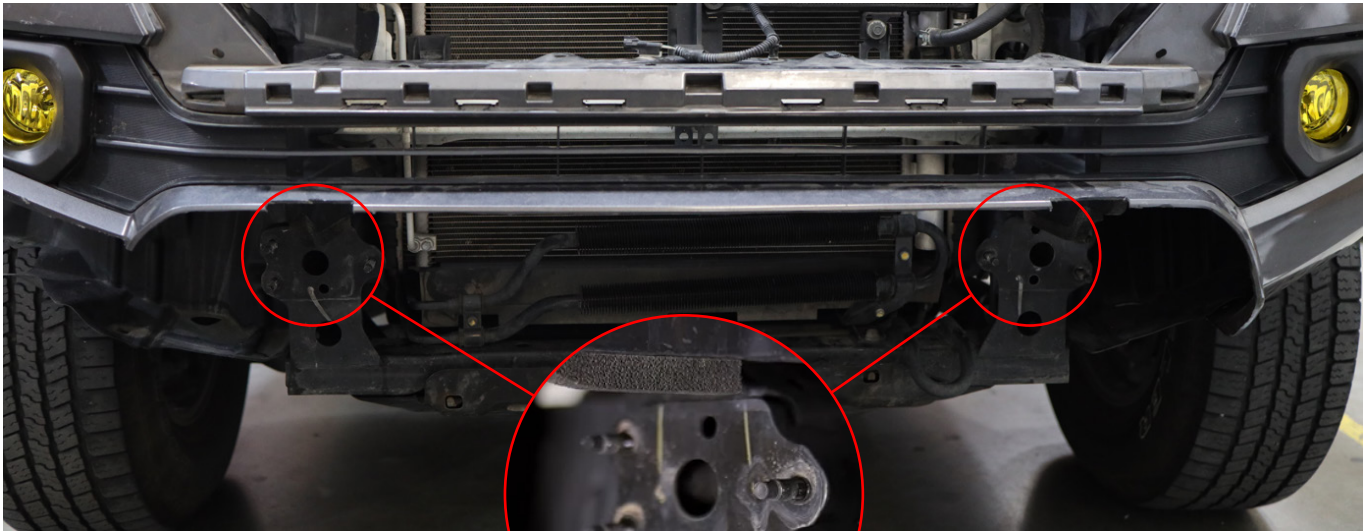

3pcs original nuts and 3pcs 9Φ12-flat washers on each underside.

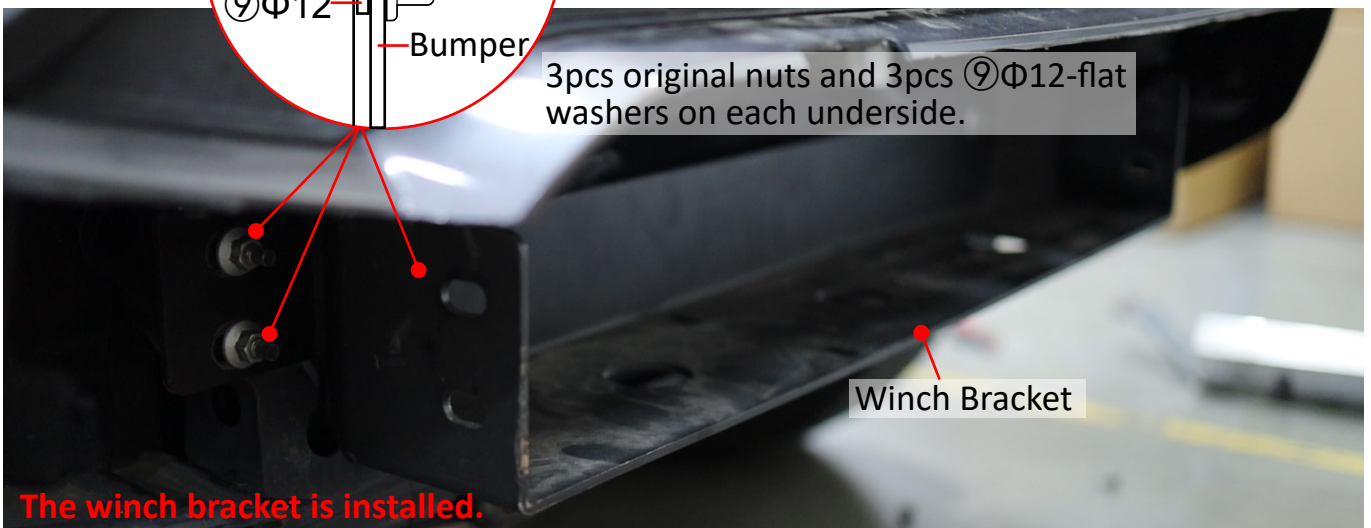

3. Mounting the light bar(not configured) on the bumper.

Note: Light bar can be purchased on your own. If you does not buy the ligh bar, this step can be ignored.

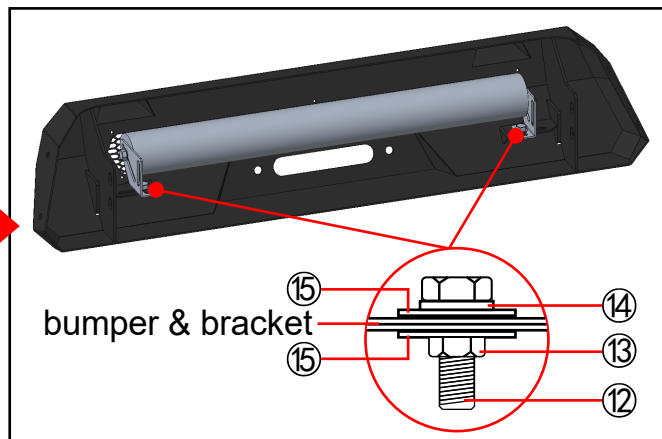
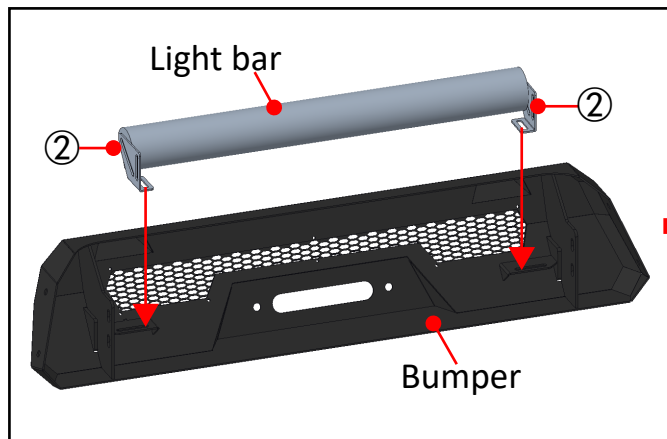
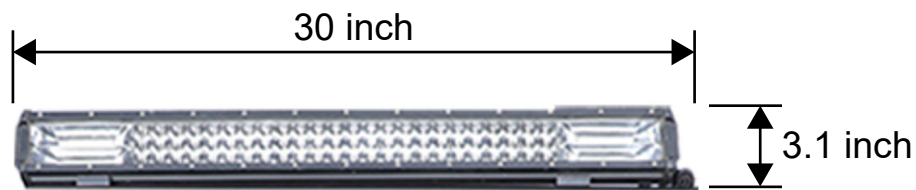

4. Mounting the license bracket on the bumper.

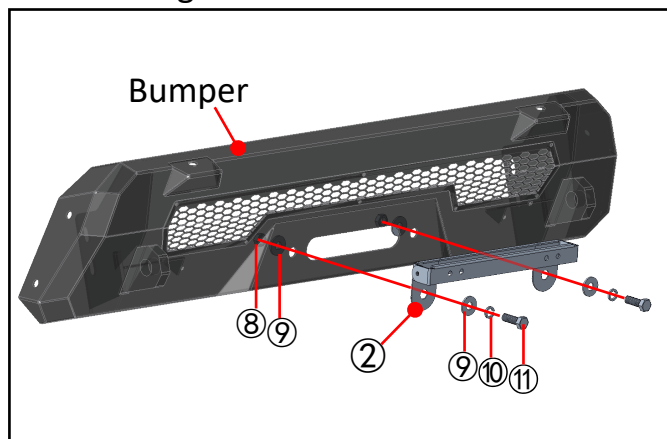

5. Mounting the bumper and winch bracket of the bolts and nuts for step 16-1.

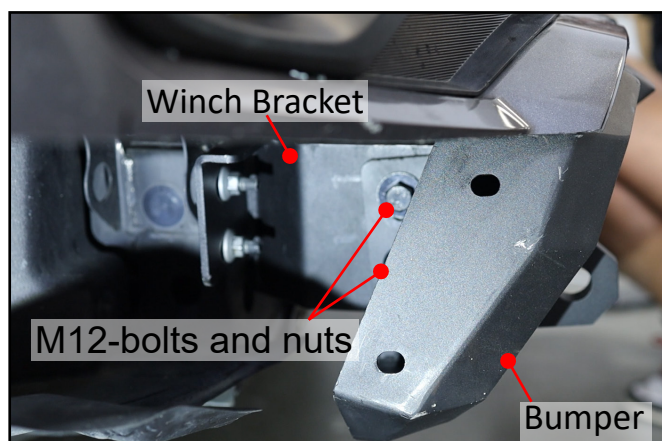
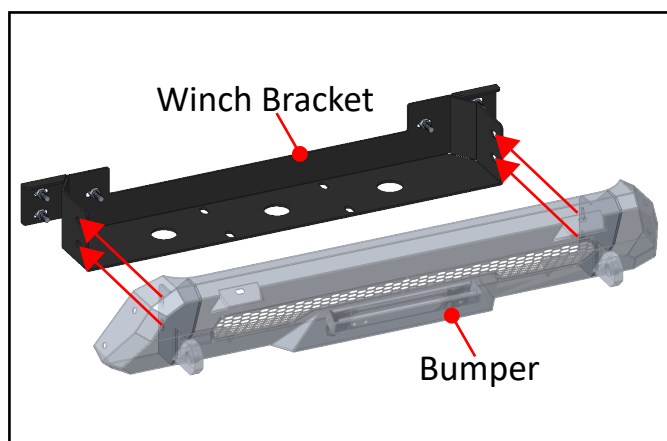

Step 17: Mounting the Shackles.



9 Shackle x2



The Bumper is installed.

FRONT BUMPER SIDE WINGS

— User Manual —

2016-2023 Toyota Tacoma

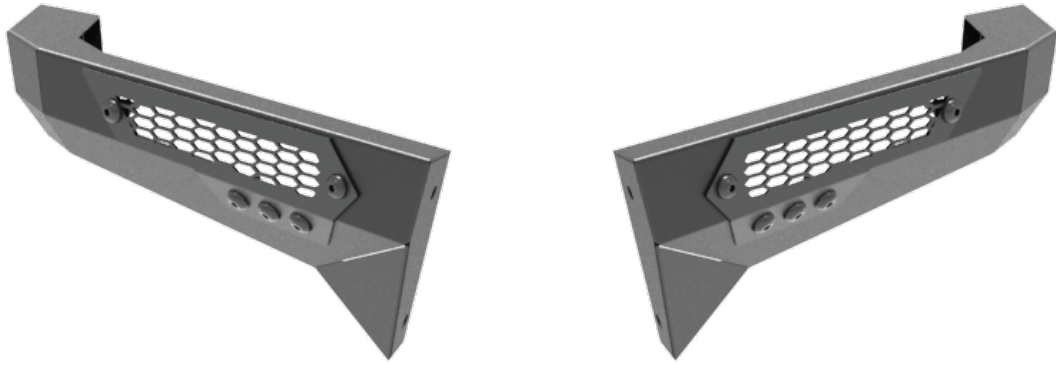

Model:	NTA01A103-2A
Material:	Q235A
Product Dimensions:	15.4 x 18.5 x 8.3 inch
Package Dimensions:	27.2 x 11.4 x 9.5 inch
Product Weight:	12.3 lbs

※ Thank you for purchasing the FRONT BUMPER Side Wings. Please read this manual carefully and keep it properly if you need to refer to it afterward. If you need any support or assistance, please contact us with your product model number and order number, and our support team will help you solve problems.







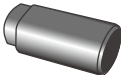

⚠ WARNING

※ This product is designed primarily to enhance the appearance of the vehicle. Do not rely in any way on the components of this product to protect against injury or death in the event of an accident. To reduce the risk of serious injury or property damage, please read all safety messages and understand all instructions and procedure notices before attempting to install or use this product.

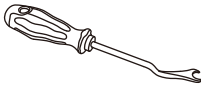

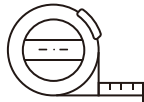

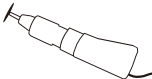
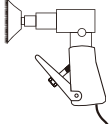

⚠ CAUTION

※ Properly torque and recheck fasteners and security of step tread after 250 miles and inspect frequently. Do not use if damaged.

REQUIRED TOOLS

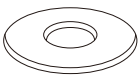
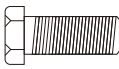
Socket 	Ratchet 	Panel Remover 	Side Cutter 	Tape Measure 
Painter's tape 	Marker 	Power Cutting Tool 	Angle Grinder 	Safety Glasses 

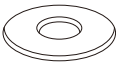
Parts Information

NO.	Parts Name	Size	Line Graph	Qty	Color
①	Side Wings L/R	/		1	Black
②	Side Wing Support	/		2	Black
③	Large Flat Washer	30x30		2	Dacro Black
④	Hex Bolts	M8x25		9	Dacro Black
⑤	Spring Washer	Φ8		9	Dacro Black
⑥	Flat Washer	Φ8x20x2		15	Dacro Black
⑦	Hex Nuts	M8		9	Dacro Black

※ **Note:**

Spare parts such as B20、 N22、 W16 and W43 are provided with 1PCS each (included in the number of parts details).

Installation Instructions

※**Note:** This installation manual takes one of the models as an example.

Step 1: Open the carton and take out the parts. Check whether the number of components is complete.

Step 2: Removing stock bumper and cutting the bumper.

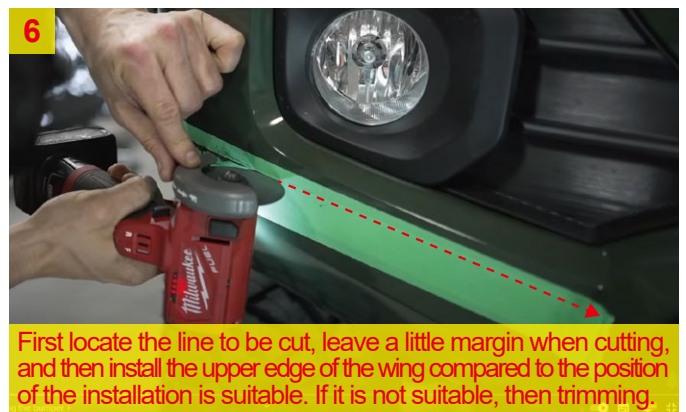
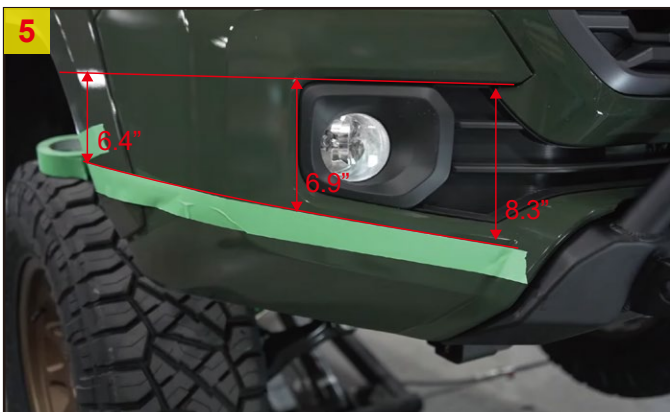
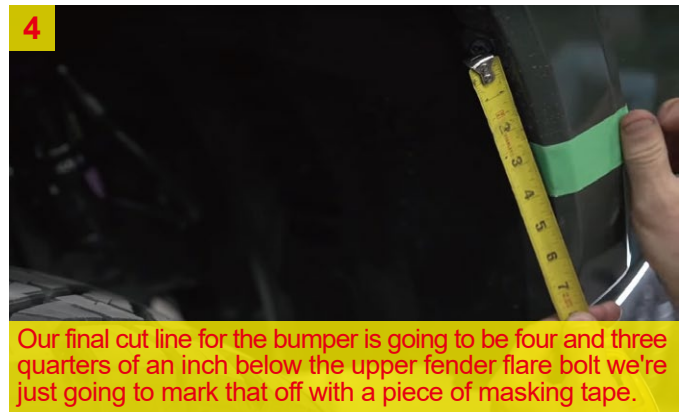
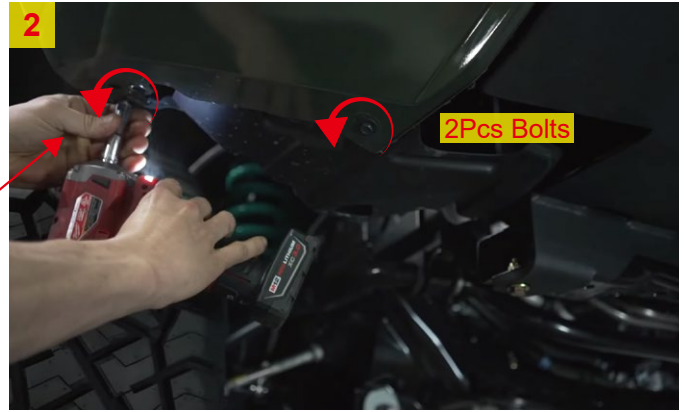

Step 3:

Install the side wings to the main body with the supplied bolts, adjust left and right to align the installation, continue trimming if the cutting point needs to be adjusted, and finally fasten the side wings.

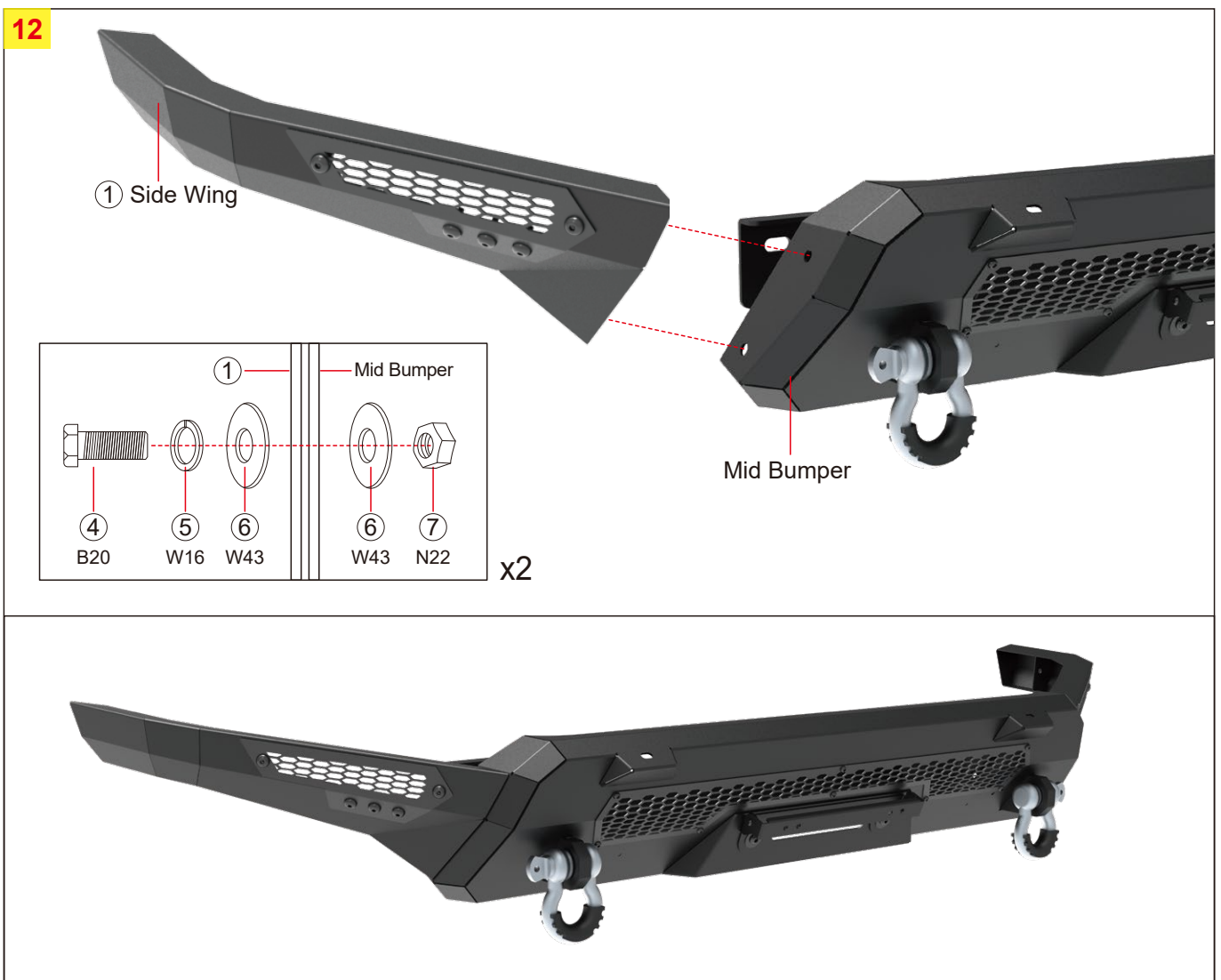
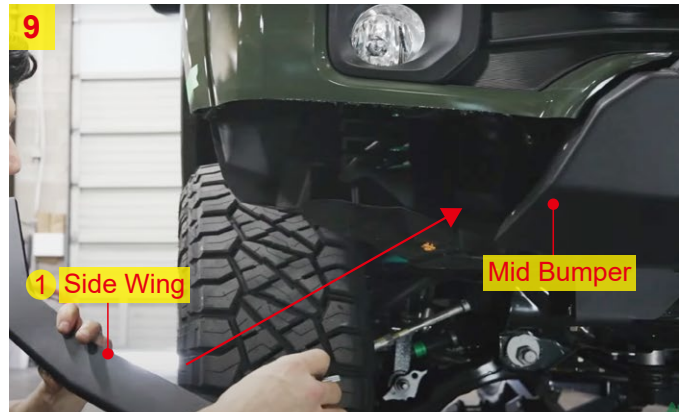

Step 4: Trimming fender liner and install the Support.

13. Install the wings to adjust the appropriate position for cutting the fender liner.



14. Cutting inner fender liner.



15



16. Drill a hole in the inner fender liner.



17

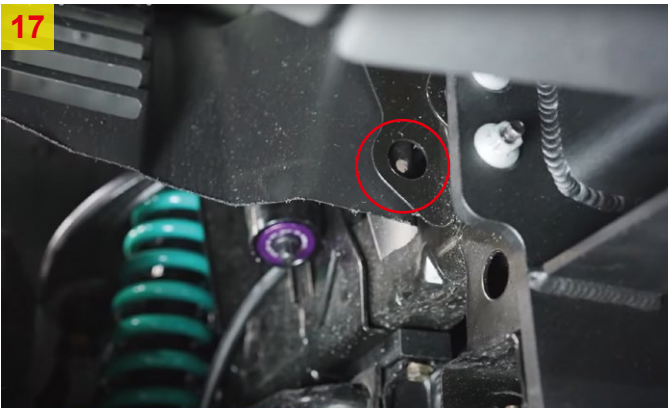

18

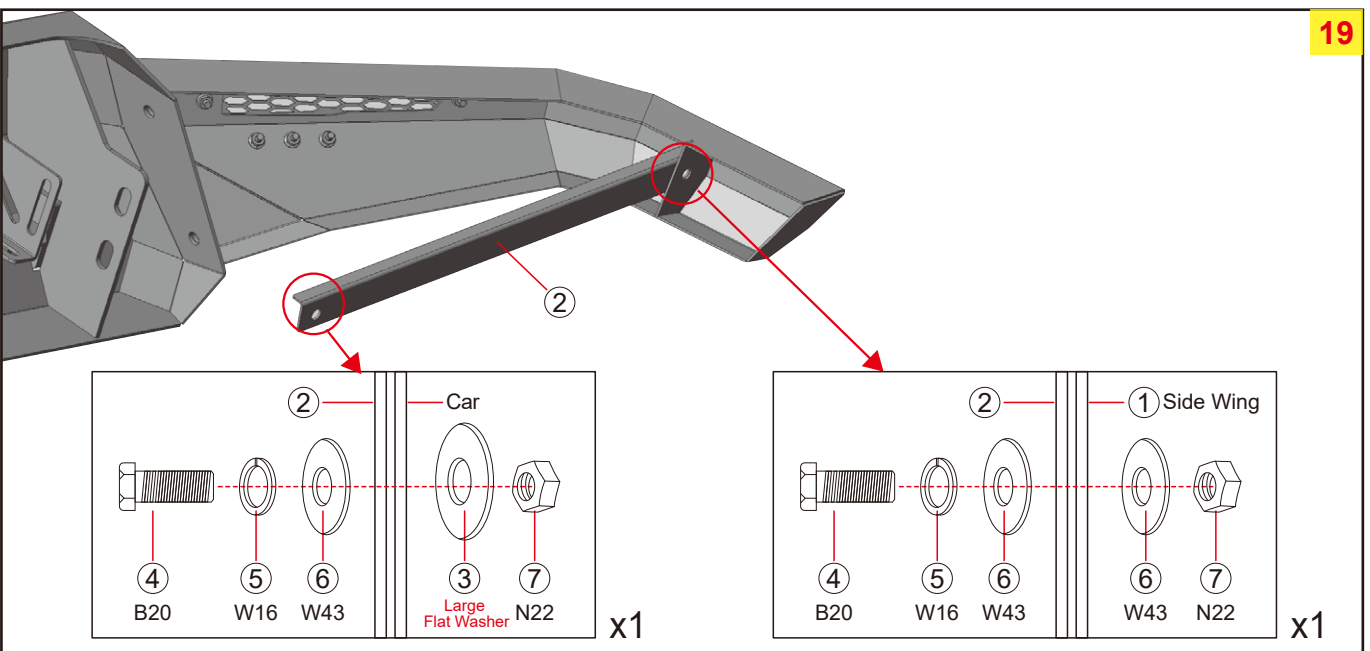



FRONT BUMPER SIDE WINGS

————— User Manual —————

2016-2023 Toyota Tacoma

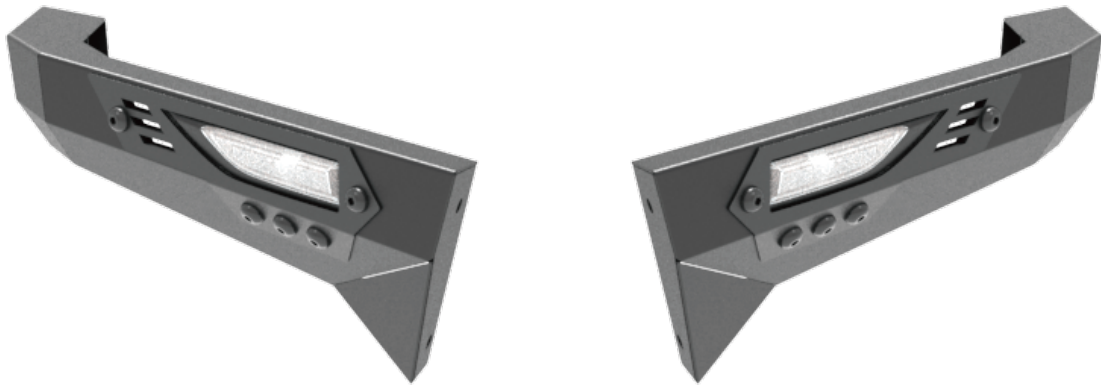

Model:	NTA01A103-2B
Material:	Q235A
Product Dimensions:	15.4 x 18.5 x 8.3 inch
Package Dimensions:	27.2 x 11.4 x 9.5 inch
Product Weight:	12.8 lbs

※ Thank you for purchasing the FRONT BUMPER Side Wings. Please read this manual carefully and keep it properly if you need to refer to it afterward. If you need any support or assistance, please contact us with your product model number and order number, and our support team will help you solve problems.









⚠ WARNING

※ This product is designed primarily to enhance the appearance of the vehicle. Do not rely in any way on the components of this product to protect against injury or death in the event of an accident. To reduce the risk of serious injury or property damage, please read all safety messages and understand all instructions and procedure notices before attempting to install or use this product.

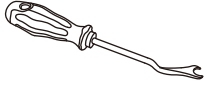
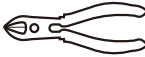



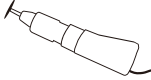
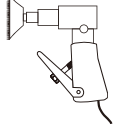



⚠ CAUTION

※ Properly torque and recheck fasteners and security of step tread after 250 miles and inspect frequently. Do not use if damaged.

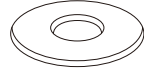
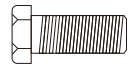
REQUIRED TOOLS

Socket 	Ratchet 	Panel Remover 	Side Cutter 	Tape Measure 
Painter's tape 	Marker 	Power Cutting Tool 	Angle Grinder 	Safety Glasses 

Parts Information

NO.	Parts Name	Size	Line Graph	Qty	Color
①	Side Wings L/R	/		1	Black
②	Side Wing Support	/		2	Black
③	Large Flat Washer	30x30		2	Dacro Black
④	B20 Hex Bolts	M8x25		9	Dacro Black
⑤	W16 Spring Washer	Φ8		9	Dacro Black
⑥	W43 Flat Washer	Φ8x20x2		15	Dacro Black
⑦	N22 Hex Nuts	M8		9	Dacro Black
⑧	Wire connector clips	/		5	Black
⑨	Cable Wires	0.75x2m		2	Black

※ **Note:**

Spare parts such as B20、 W16、 W43 and N22 are provided with 1PCS each (included in the number of parts details).

Installation Instructions

※**Note:** This installation manual takes one of the models as an example.

Step 1: Open the carton and take out the parts. Check whether the number of components is complete.

Step 2: Removing stock bumper and cutting the bumper.

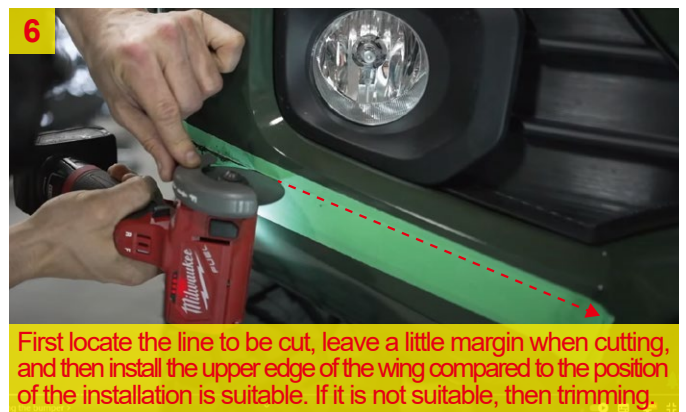
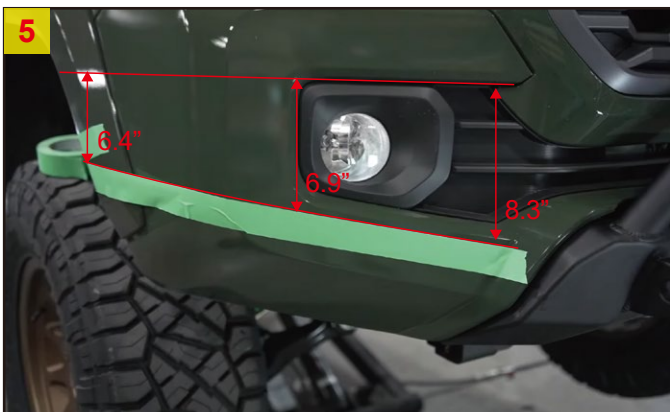
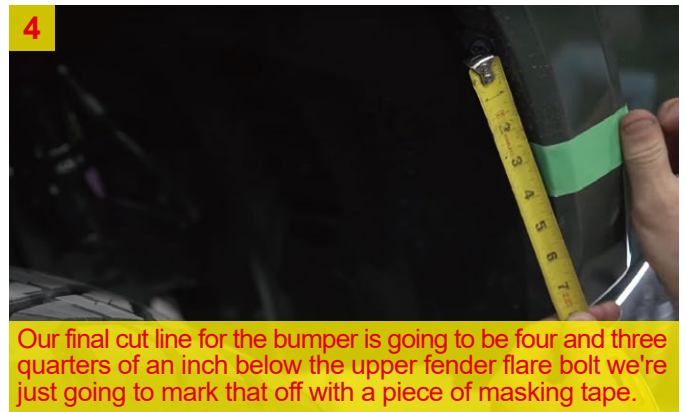
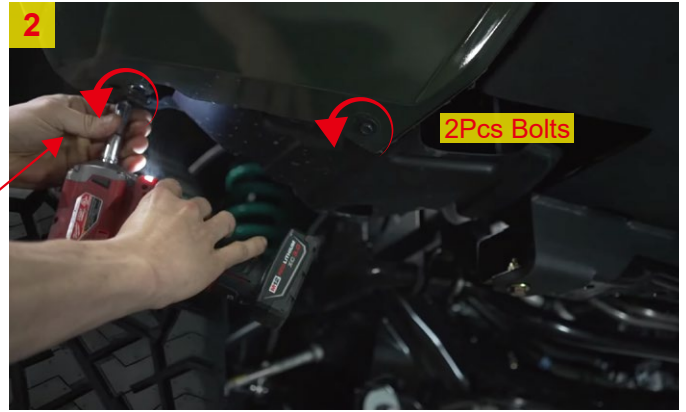

Step 3:

Install the side wings to the main body with the supplied bolts, adjust left and right to align the installation, continue trimming if the cutting point needs to be adjusted, and finally fasten the side wings.

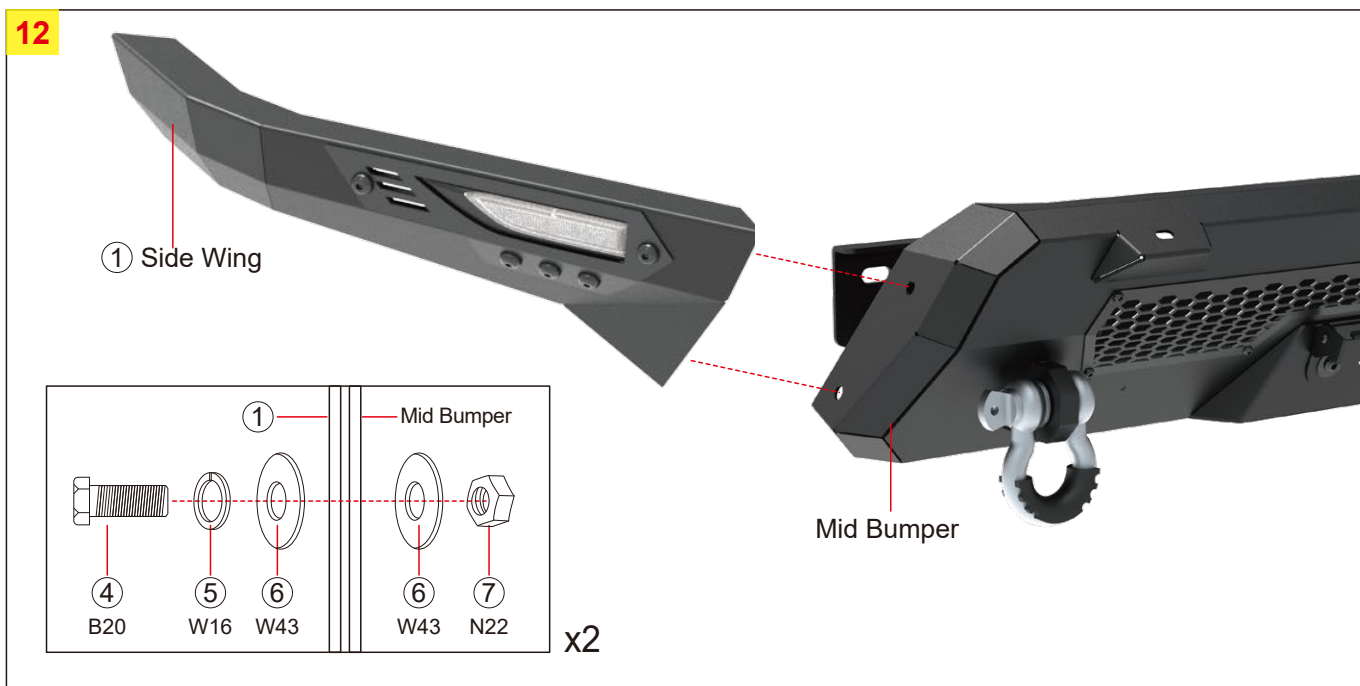
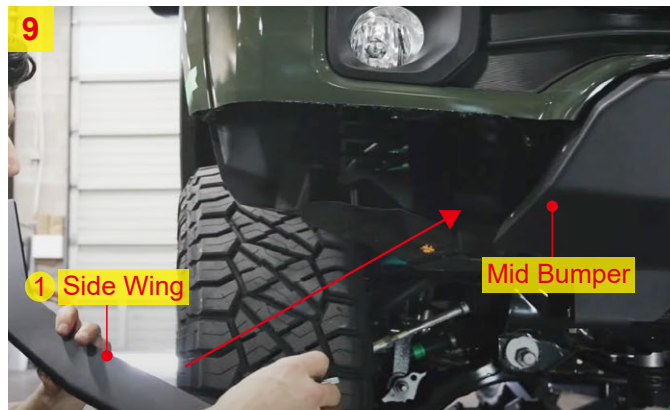

Step 4:

Connect the side wing turn signal light harness to the headlight turn signal function wire harness.

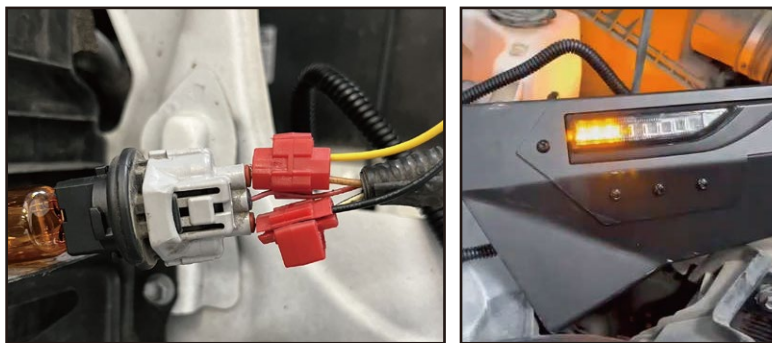

Step 5: Trimming fender liner.

13. Install the wings to adjust the appropriate position for cutting the fender liner.



14. Cutting inner fender liner.



15



16. Drill a hole in the inner fender liner.

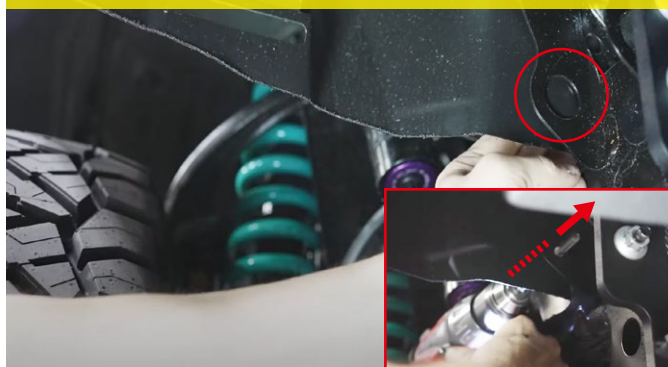

17

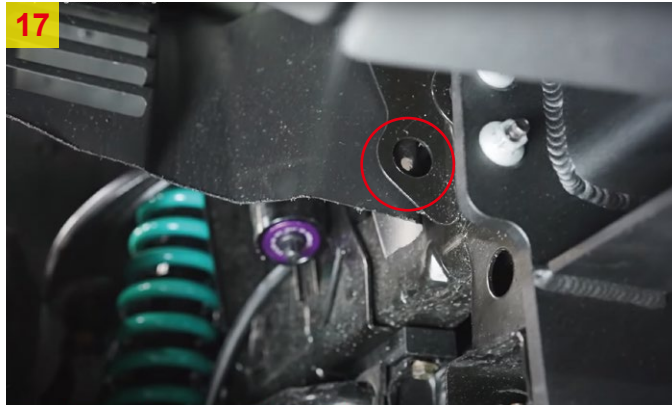

18



Step 6: Install the Support.

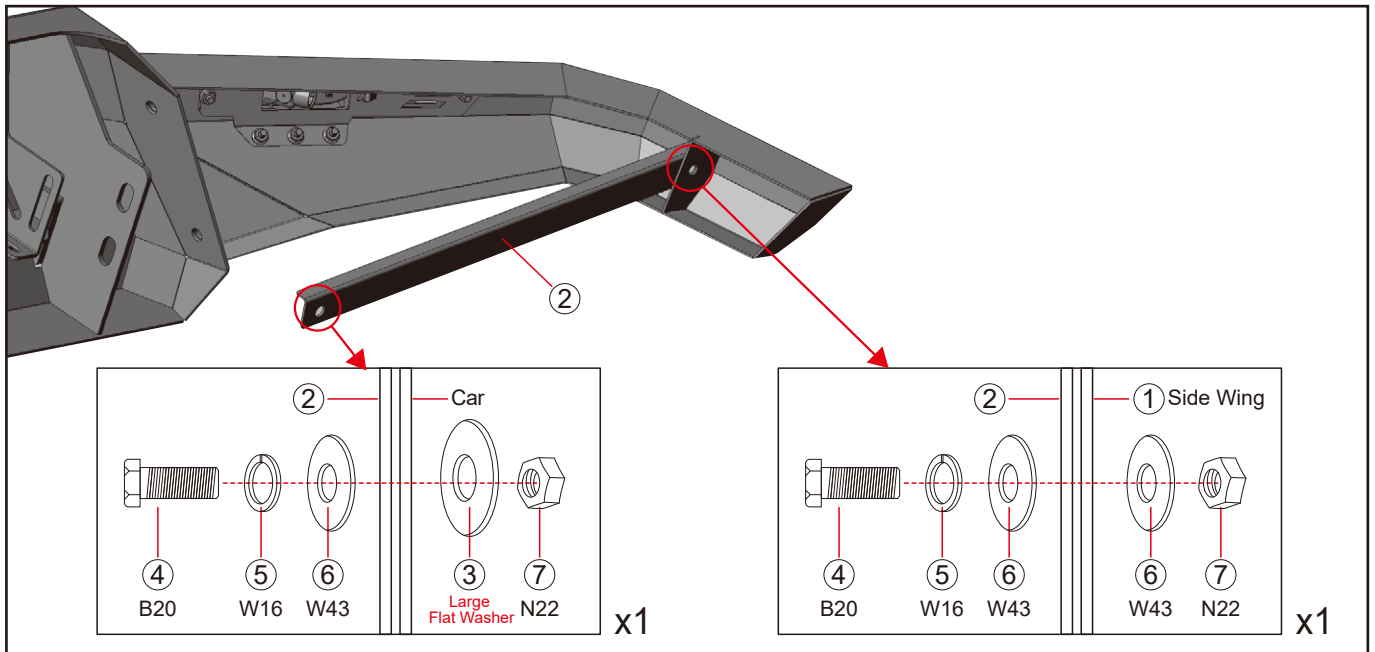

FRONT BUMPER SIDE WINGS

————— User Manual —————

2016-2023 Toyota Tacoma



Model:	NTA01A103-2C
Material:	Q235A
Product Dimensions:	16.3 x 18.5 x 8.2 inch
Package Dimensions:	27.2 x 15.4 x 10.6 inch
Product Weight:	15.4 lbs

※ Thank you for purchasing the FRONT BUMPER Side Wings. Please read this manual carefully and keep it properly if you need to refer to it afterward. If you need any support or assistance, please contact us with your product model number and order number, and our support team will help you solve problems.







⚠ WARNING

※ This product is designed primarily to enhance the appearance of the vehicle. Do not rely in any way on the components of this product to protect against injury or death in the event of an accident. To reduce the risk of serious injury or property damage, please read all safety messages and understand all instructions and procedure notices before attempting to install or use this product.

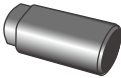

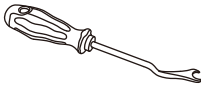
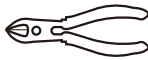
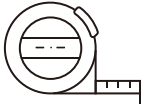

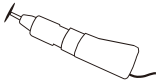
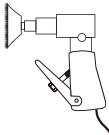

⚠ CAUTION

※ Properly torque and recheck fasteners and security of step tread after 250 miles and inspect frequently. Do not use if damaged.

REQUIRED TOOLS

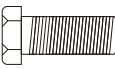
Socket 	Ratchet 	Panel Remover 	Side Cutter 	Tape Measure 
Painter's tape 	Marker 	Power Cutting Tool 	Angle Grinder 	Safety Glasses 

Parts Information

NO.		Parts Name	Size	Line Graph	Qty	Color
①	/	Side Wings L/R	/		1	Black
②	/	Side Wing Support	/		2	Black
③	/	Large Flat Washer	30x30		2	Dacro Black
④	B20	Hex Bolts	M8x25		9	Dacro Black
⑤	W16	Spring Washer	Φ8		9	Dacro Black
⑥	W43	Flat Washer	Φ8x20x2		11	Dacro Black
⑦	N22	Hex Nuts	M8		5	Dacro Black

※ **Note:**

Spare parts such as B20、 N22、 W16 and W43 are provided with 1PCS each (included in the number of parts details).

Installation Instructions

※**Note:** This installation manual takes one of the models as an example.

Step 1: Open the carton and take out the parts. Check whether the number of components is complete.

Step 2: Removing stock bumper and cutting the bumper.

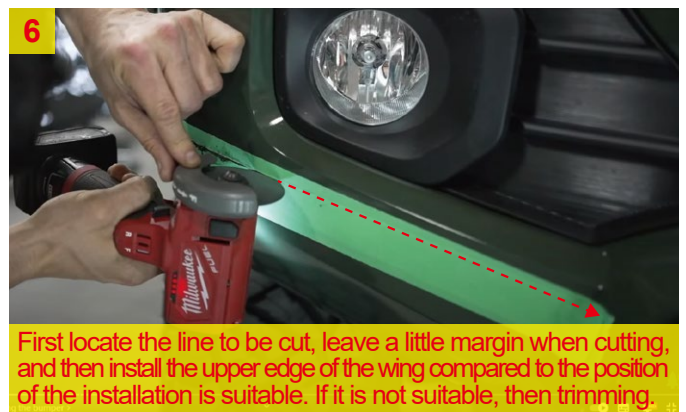
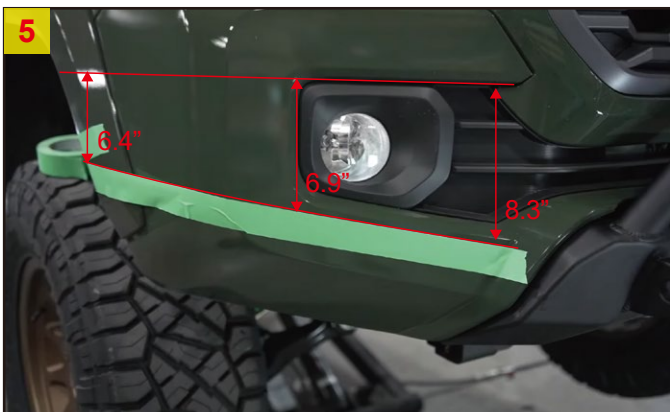
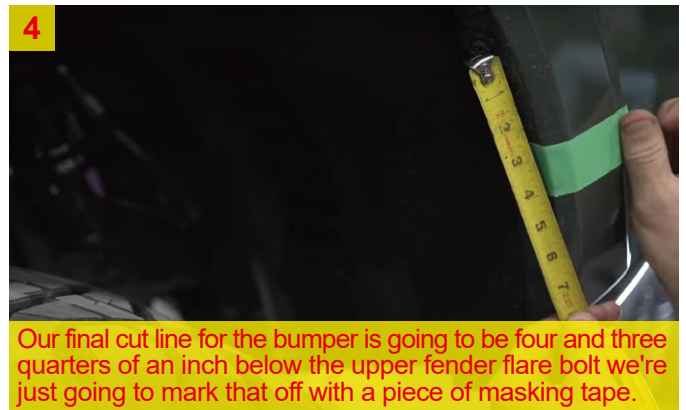

Step 3:

Install the side wings to the main body with the supplied bolts, adjust left and right to align the installation, continue trimming if the cutting point needs to be adjusted, and finally fasten the side wings.

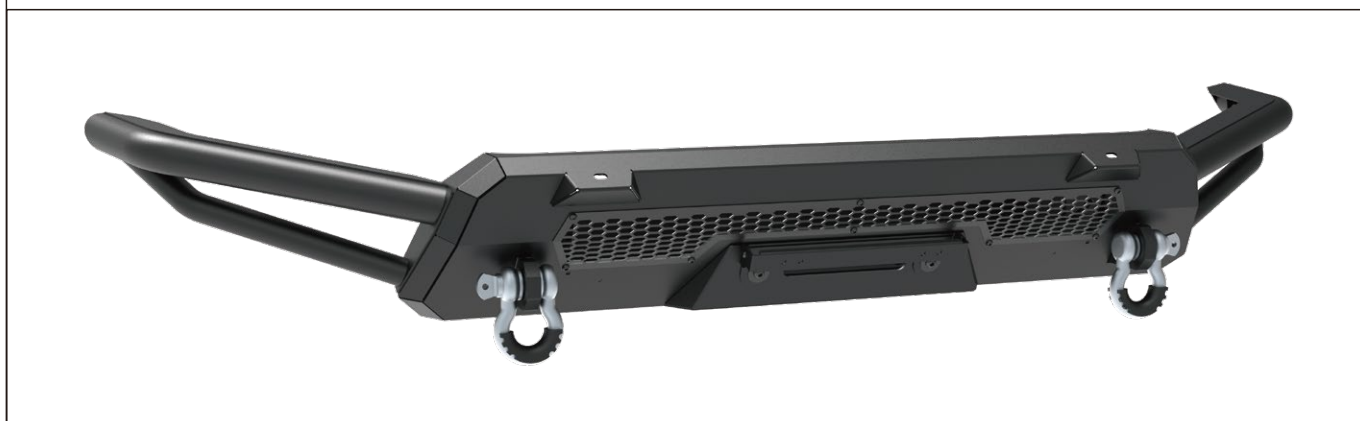
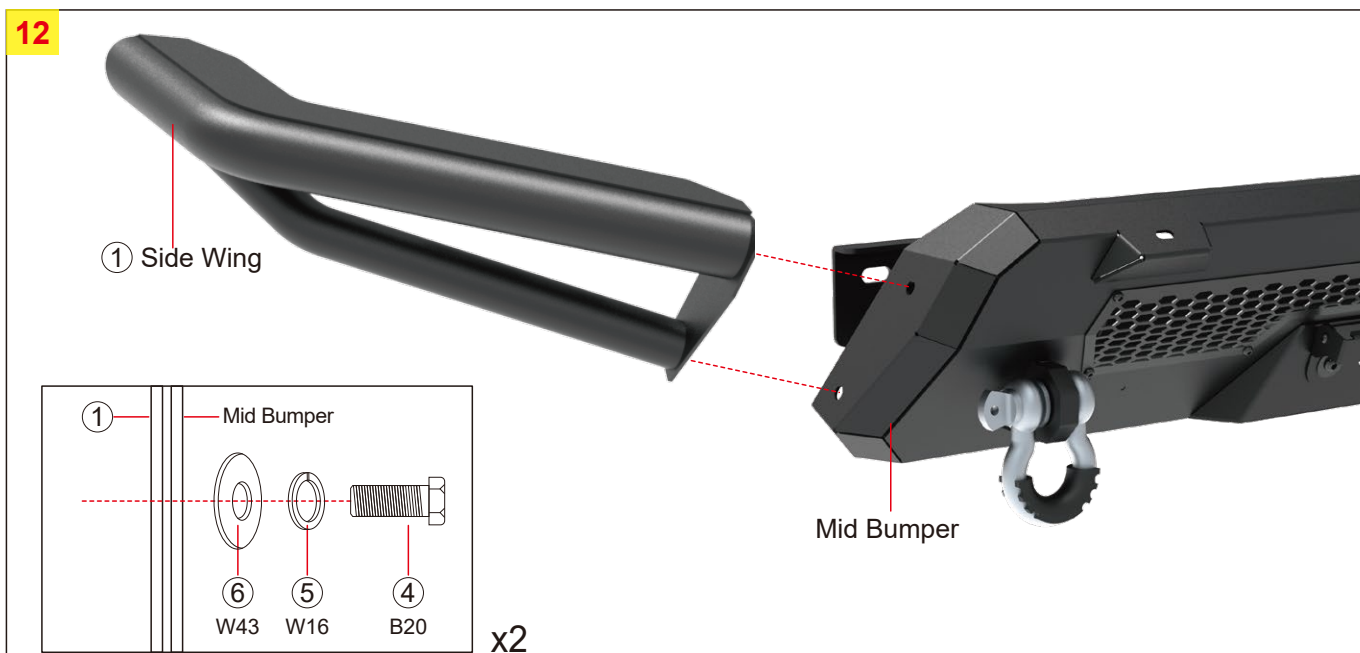
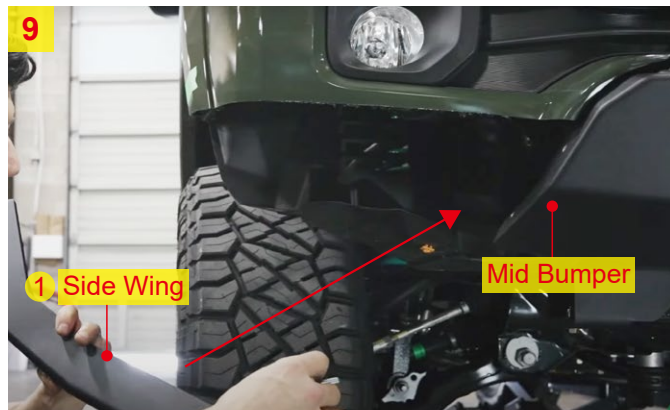

Step 4: Trimming fender liner and install the Support.

13. Install the wings to adjust the appropriate position for cutting the fender liner.



14. Cutting inner fender liner.



15



16. Drill a hole in the inner fender liner.



17



18



19

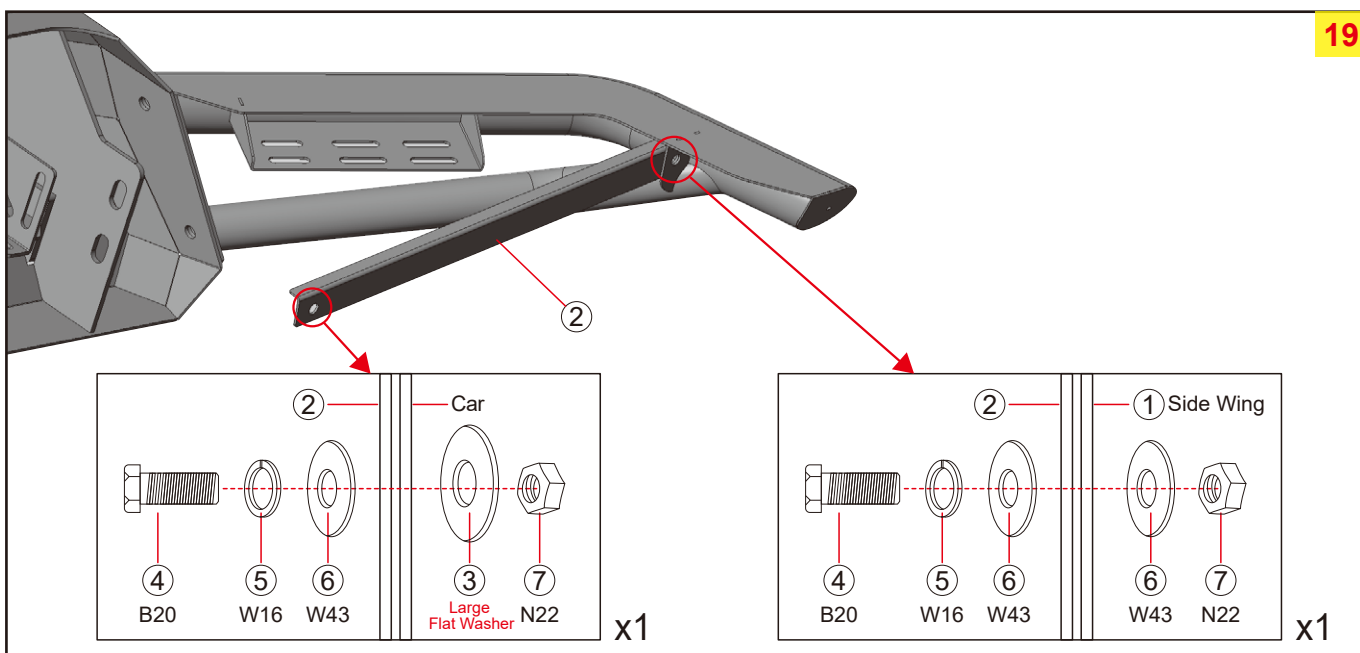



FRONT BUMPER Bull Bar

————— User Manual —————

2016-2023 Toyota Tacoma



Model:	NTA01A103-3A
Material:	Q235A
Product Dimensions:	32.2 x 3.7 x 5.7 inch
Package Dimensions:	35.4 x 4.3 x 9.4 inch
Product Weight:	3.1 lbs

※ Thank you for purchasing the FRONT BUMPER Bull Bar. Please read this manual carefully and keep it properly if you need to refer to it afterward. If you need any support or assistance, please contact us with your product model number and order number, and our support team will help you solve problems.

⚠ WARNING

※ This product is designed primarily to enhance the appearance of the vehicle. Do not rely in any way on the components of this product to protect against injury or death in the event of an accident. To reduce the risk of serious injury or property damage, please read all safety messages and understand all instructions and procedure notices before attempting to install or use this product.





⚠ CAUTION

※ Properly torque and recheck fasteners and security of step tread after 250 miles and inspect frequently. Do not use if damaged.

REQUIRED TOOLS

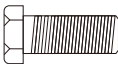
Socket 	Ratchet 	Safety Glasses 
---	--	---

Parts Information

NO.		Parts Name	Size	Line Graph	Qty	Color
①	/	Bull Bar	/		1	Black
②	B20	Hex Bolts	M8x25		3	Dacro Black
③	W16	Spring Washer	Φ8		3	Dacro Black
④	W19	Flat Washer	Φ8x24x2		5	Dacro Black
⑤	N22	Hex Nuts	M8		3	Dacro Black

※**Note:**

Spare parts such as B20、 W16、 W19 and N22 are provided with 1PCS each (included in the number of parts details).

Installation Instructions

Step 1: Open the carton and take out the parts. Check whether the number of components is complete.

Step 2: Install the Bull Bar.

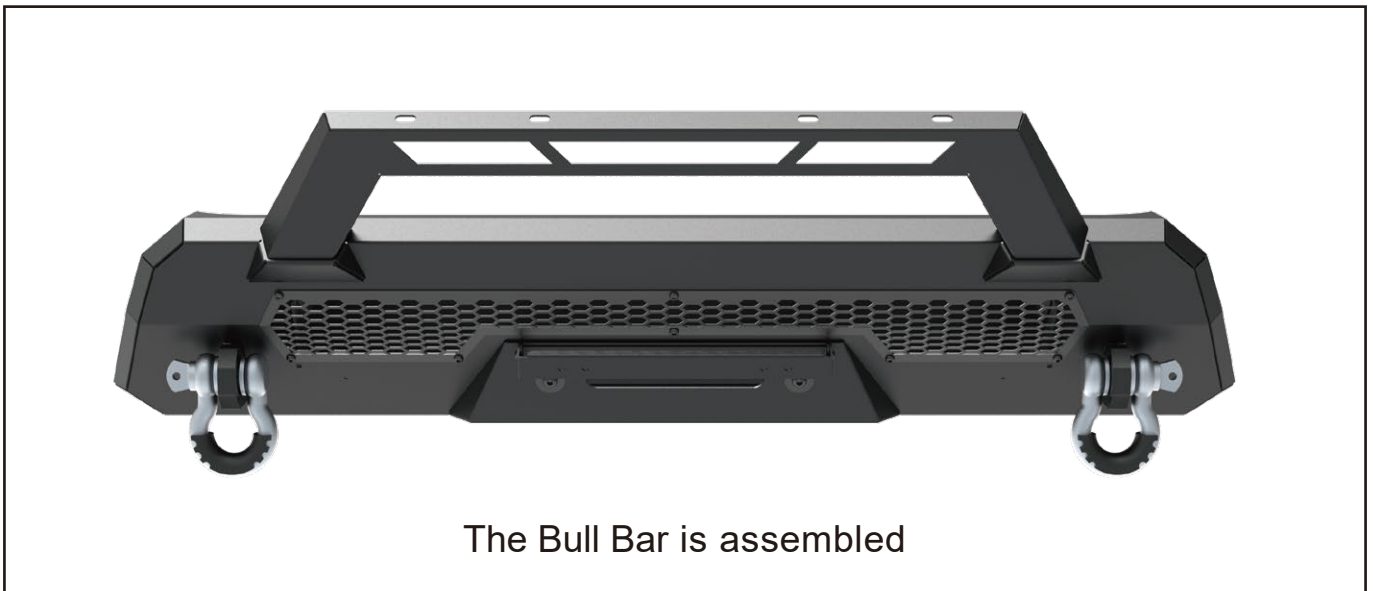

FRONT BUMPER Bull Bar

————— User Manual —————

2016-2023 Toyota Tacoma



Model:	NTA01A103-3B
Material:	Q235A
Product Dimensions:	30.8 x 4.8 x 6.9 inch
Package Dimensions:	33.6 x 4.7 x 9.4 inch
Product Weight:	6.6 lbs

※ Thank you for purchasing the FRONT BUMPER Bull Bar. Please read this manual carefully and keep it properly if you need to refer to it afterward. If you need any support or assistance, please contact us with your product model number and order number, and our support team will help you solve problems.



⚠ WARNING

※ This product is designed primarily to enhance the appearance of the vehicle. Do not rely in any way on the components of this product to protect against injury or death in the event of an accident. To reduce the risk of serious injury or property damage, please read all safety messages and understand all instructions and procedure notices before attempting to install or use this product.

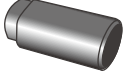

⚠ CAUTION

※ Properly torque and recheck fasteners and security of step tread after 250 miles and inspect frequently. Do not use if damaged.

REQUIRED TOOLS

<p>Socket</p> 	<p>Ratchet</p> 	<p>Safety Glasses</p> 
---	--	---

Parts Information

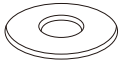
NO.		Parts Name	Size	Line Graph	Qty	Color
①	/	Bull Bar	/		1	Black
②	B20	Hex Bolts	M8x25		3	Dacro Black
③	W16	Spring Washer	Φ8		3	Dacro Black
④	W19	Flat Washer	Φ8x24x2		3	Dacro Black

※ **Note:**

Spare parts such as B20、 W16 and W19 are provided with 1PCS each (included in the number of parts details).

Installation Instructions

Step 1: Open the carton and take out the parts. Check whether the number of components is complete.

Step 2: Install the Bull Bar.

